

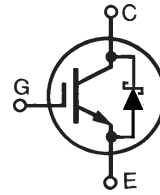

**THE DATASHEET OF  
IXGH48N60B3C1**



**GenX3™ 600V IGBT  
w/ SiC Anti-Parallel  
Diode**
**IXGH48N60B3C1**

$$\begin{aligned}
 V_{CES} &= 600V \\
 I_{C110} &= 48A \\
 V_{CE(sat)} &\leq 1.8V \\
 t_{fi(typ)} &= 116ns
 \end{aligned}$$

 Medium Speed Low V<sub>sat</sub> PT  
IGBT 5 - 40 kHz Switching

TO-247

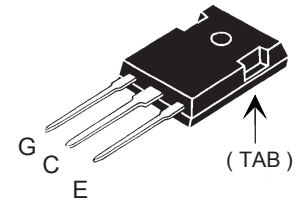
 G = Gate      C = Collector  
E = Emitter    TAB = Collector

Symbol	Test Conditions	Maximum Ratings	
$V_{CES}$	$T_C = 25^\circ\text{C}$ to $150^\circ\text{C}$	600	V
$V_{CGR}$	$T_J = 25^\circ\text{C}$ to $150^\circ\text{C}$ , $R_{GE} = 1M\Omega$	600	V
$V_{GES}$	Continuous	$\pm 20$	V
$V_{GEM}$	Transient	$\pm 30$	V
$I_{C25}$	$T_C = 25^\circ\text{C}$ (Limited by Leads)	75	A
$I_{C110}$	$T_C = 110^\circ\text{C}$	48	A
$I_{F110}$	$T_C = 110^\circ\text{C}$	20	A
$I_{CM}$	$T_C = 25^\circ\text{C}$ , 1ms	280	A
<b>SSOA</b> <b>(RBSOA)</b>	$V_{GE} = 15V$ , $T_{VJ} = 125^\circ\text{C}$ , $R_G = 5\Omega$ Clamped Inductive Load	$I_{CM} = 120$ @ $\leq V_{CES}$	A
$P_C$	$T_C = 25^\circ\text{C}$	300	W
$T_J$		-55 ... +150	$^\circ\text{C}$
$T_{JM}$		150	$^\circ\text{C}$
$T_{stg}$		-55 ... +150	$^\circ\text{C}$
$T_L$	1.6mm (0.062 in.) from Case for 10s	300	$^\circ\text{C}$
$T_{SOLD}$	Plastic Body for 10 seconds	260	$^\circ\text{C}$
$M_d$	Mounting Torque	1.13/10	Nm/lb.in.
<b>Weight</b>		6	g

**Features**

- Optimized for Low Conduction and Switching Losses
- Square RBSOA
- Anti-Parallel Schottky Diode
- International Standard Package

**Advantages**

- High Power Density
- Low Gate Drive Requirement

**Applications**

- Power Inverters
- UPS
- Motor Drives
- SMPS
- PFC Circuits
- Battery Chargers
- Welding Machines
- Lamp Ballasts

Symbol	Test Conditions ( $T_J = 25^\circ\text{C}$ Unless Otherwise Specified)	Characteristic Values		
		Min.	Typ.	Max.
$BV_{CES}$	$I_C = 250\mu\text{A}$ , $V_{GE} = 0V$	600		V
$V_{GE(th)}$	$I_C = 250\mu\text{A}$ , $V_{CE} = V_{GE}$	3.0		5.0 V
$I_{CES}$	$V_{CE} = V_{CES}$ , $V_{GE} = 0V$ $T_J = 125^\circ\text{C}$			50 $\mu\text{A}$ 1.75 mA
$I_{GES}$	$V_{CE} = 0V$ , $V_{GE} = \pm 20V$			$\pm 100$ nA
$V_{CE(sat)}$	$I_C = 32A$ , $V_{GE} = 15V$ , Note 1			1.8 V

Symbol Test Conditions ( $T_J = 25^\circ\text{C}$ Unless Otherwise Specified)		Characteristic Values		
		Min.	Typ.	Max.
$g_{fs}$	$I_C = 30\text{A}, V_{CE} = 10\text{V}, \text{Note 1}$	28	46	S
$C_{ies}$	$V_{CE} = 25\text{V}, V_{GE} = 0\text{V}, f = 1\text{MHz}$		3980	pF
$C_{oes}$			190	pF
$C_{res}$			45	pF
$Q_g$	$I_C = 40\text{A}, V_{GE} = 15\text{V}, V_{CE} = 0.5 \cdot V_{CES}$		115	nC
$Q_{ge}$			21	nC
$Q_{gc}$			40	nC
$t_{d(on)}$	<b>Inductive Load, <math>T_J = 25^\circ\text{C}</math></b> $I_C = 30\text{A}, V_{GE} = 15\text{V}$ $V_{CE} = 480\text{V}, R_G = 5\Omega$ Note 2		22	ns
$t_{ri}$			26	ns
$E_{on}$			0.45	mJ
$t_{d(off)}$			130	200 ns
$t_{fi}$			116	200 ns
$E_{off}$			0.66	1.20 mJ
$t_{d(on)}$	<b>Inductive Load, <math>T_J = 125^\circ\text{C}</math></b> $I_C = 30\text{A}, V_{GE} = 15\text{V}$ $V_{CE} = 480\text{V}, R_G = 5\Omega$ Note 2		22	ns
$t_{ri}$			26	ns
$E_{on}$			0.50	mJ
$t_{d(off)}$			190	ns
$t_{fi}$			157	ns
$E_{off}$			1.30	mJ
$R_{thJC}$			0.42	$^\circ\text{C/W}$
$R_{thCS}$		0.21		$^\circ\text{C/W}$

### TO-247 (IXGH) Outline

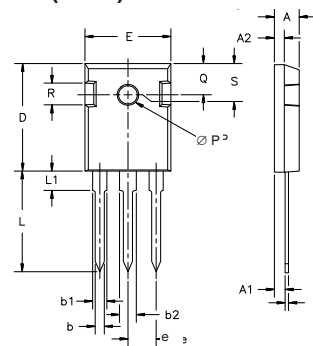

Dim.	Millimeter		Inches	
	Min.	Max.	Min.	Max.
A	4.7	5.3	.185	.209
A <sub>1</sub>	2.2	2.54	.087	.102
A <sub>2</sub>	2.2	2.6	.059	.098
b	1.0	1.4	.040	.055
b <sub>1</sub>	1.65	2.13	.065	.084
b <sub>2</sub>	2.87	3.12	.113	.123
C	.4	.8	.016	.031
D	20.80	21.46	.819	.845
E	15.75	16.26	.610	.640
e	5.20	5.72	0.205	0.225
L	19.81	20.32	.780	.800
L1		4.50		.177
∅P	3.55	3.65	.140	.144
Q	5.89	6.40	0.232	0.252
R	4.32	5.49	.170	.216
S	6.15	BSC	242	BSC

### Reverse Diode (SiC)

Symbol Test Conditions ( $T_J = 25^\circ\text{C}$ Unless Otherwise Specified)		Characteristic Values		
		Min.	Typ.	Max.
$V_F$	$I_F = 20\text{A}, V_{GE} = 0\text{V}, \text{Note 1}$		1.65	V
	$T_J = 125^\circ\text{C}$		1.80	V
$R_{thJC}$			0.90	$^\circ\text{C/W}$

### Notes

1. Pulse test,  $t \leq 300\mu\text{s}$ , duty cycle,  $d \leq 2\%$ .
2. Switching times & energy losses may increase for higher  $V_{CE}$  (Clamp),  $T_J$  or  $R_G$ .

### PRELIMINARY TECHNICAL INFORMATION

The product presented herein is under development. The Technical Specifications offered are derived from data gathered during objective characterizations of preliminary engineering lots; but also may yet contain some information supplied during a pre-production design evaluation. IXYS reserves the right to change limits, test conditions, and dimensions without notice.

### IXYS Reserves the Right to Change Limits, Test Conditions and Dimensions.

IXYS MOSFETs and IGBTs are covered by one or more of the following U.S. patents:	4,835,592	4,931,844	5,049,961	5,237,481	6,162,665	6,404,065 B1	6,683,344	6,727,585	7,005,734 B2	7,157,338B2
	4,850,072	5,017,508	5,063,307	5,381,025	6,259,123 B1	6,534,343	6,710,405 B2	6,759,692	7,063,975 B2	
	4,881,106	5,034,796	5,187,117	5,486,715	6,306,728 B1	6,583,505	6,710,463	6,771,478 B2	7,071,537	

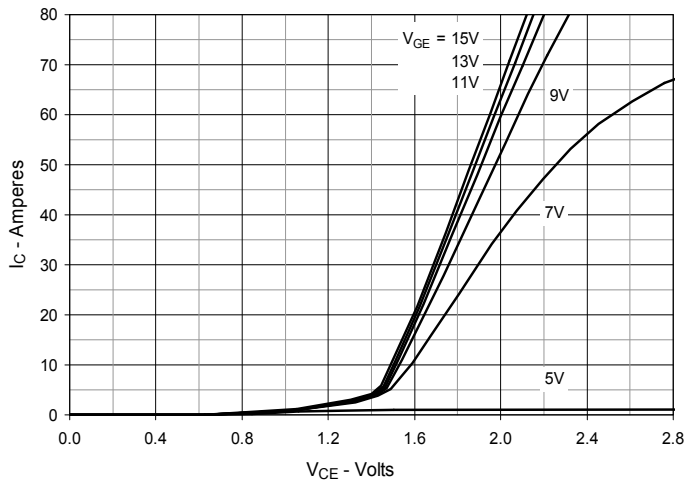
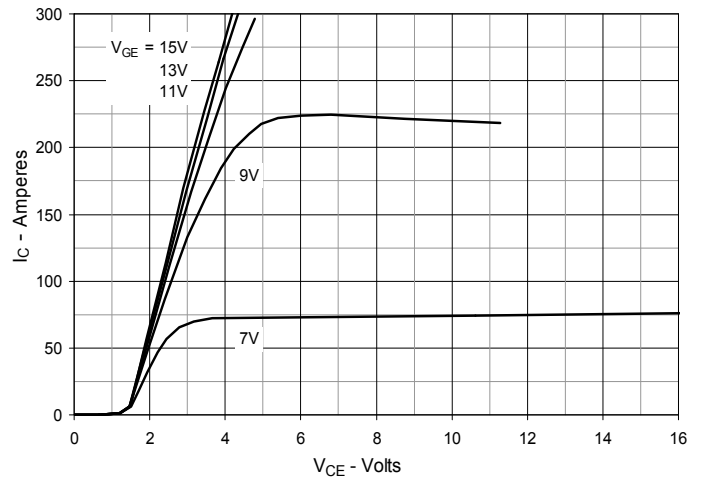
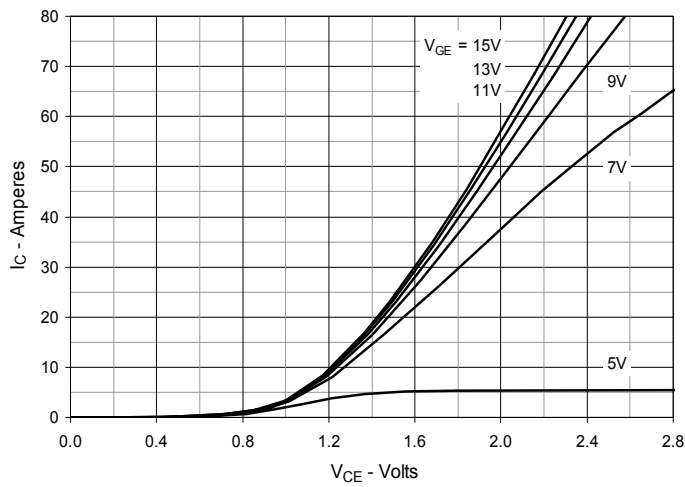
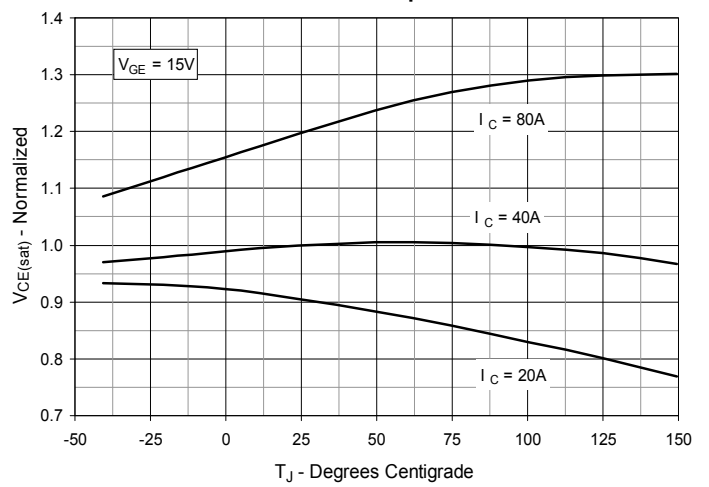
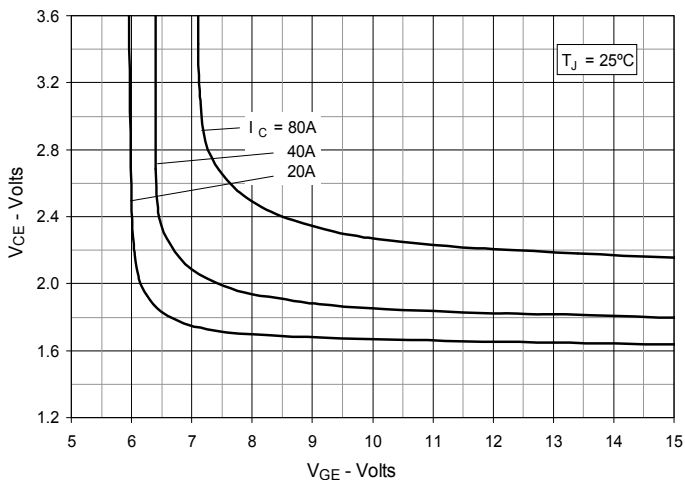
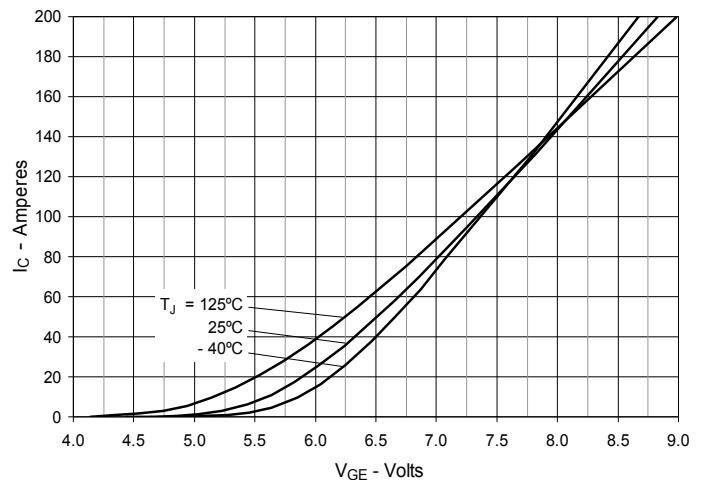
**Fig. 1. Output Characteristics  
@ 25°C**

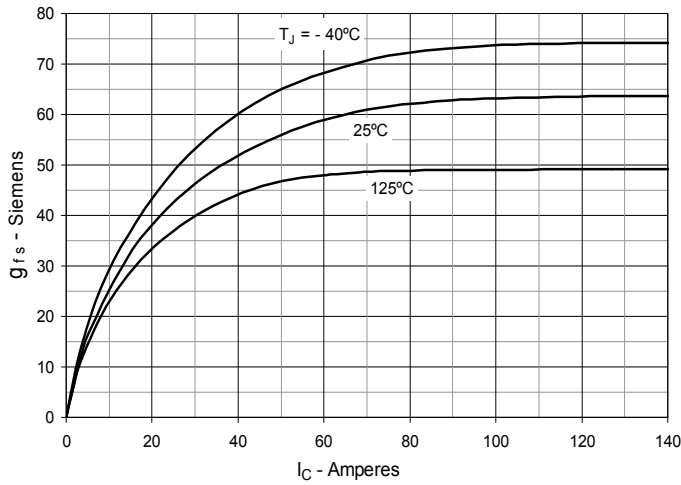
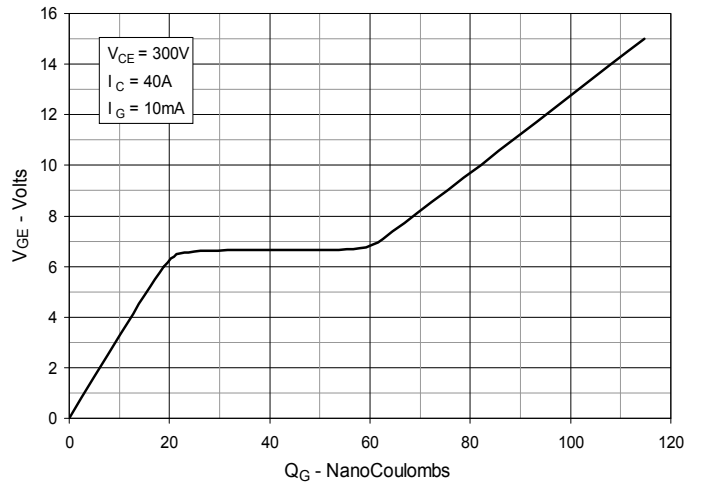
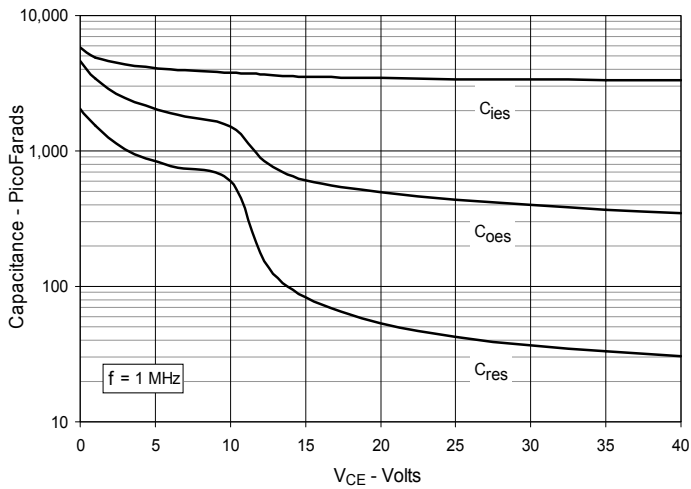
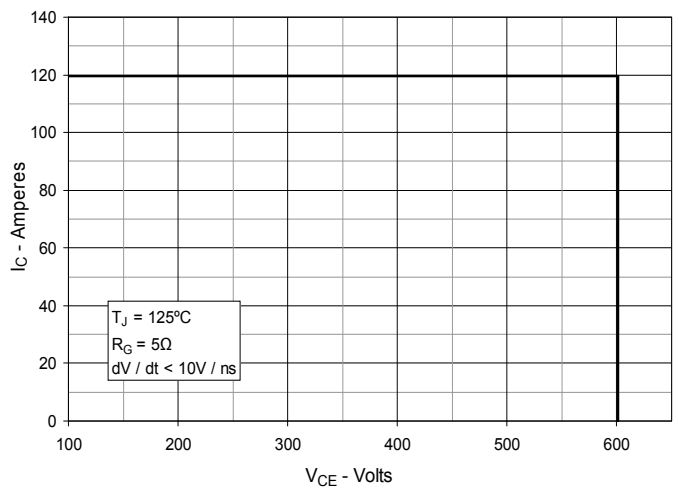
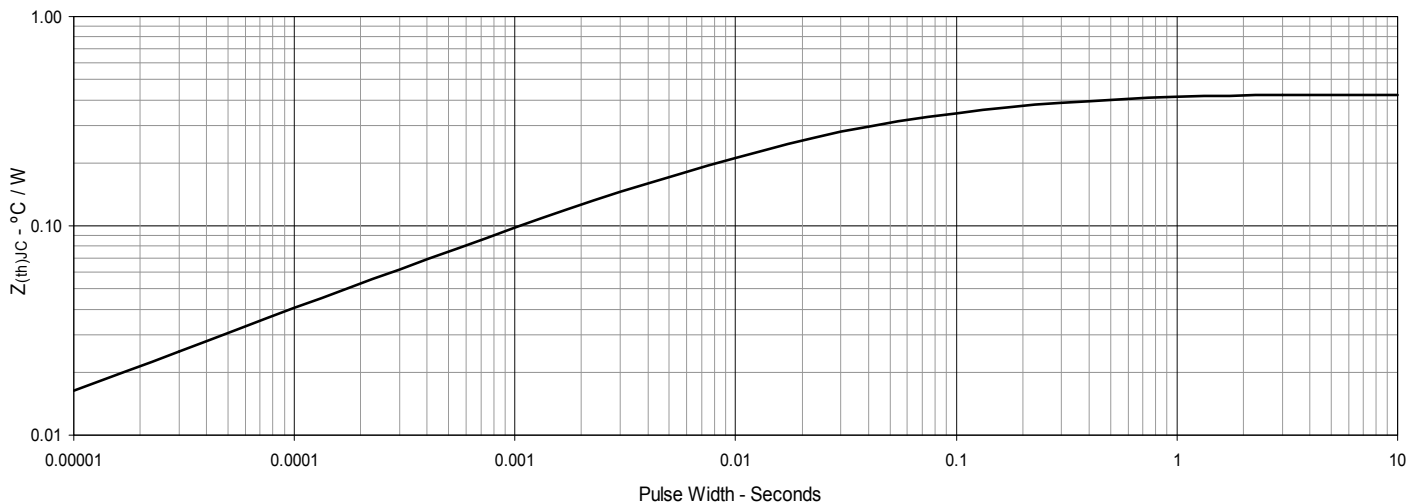
**Fig. 2. Extended Output Characteristics  
@ 25°C**

**Fig. 3. Output Characteristics  
@ 125°C**

**Fig. 4. Dependence of  $V_{CE(sat)}$  on  
Junction Temperature**

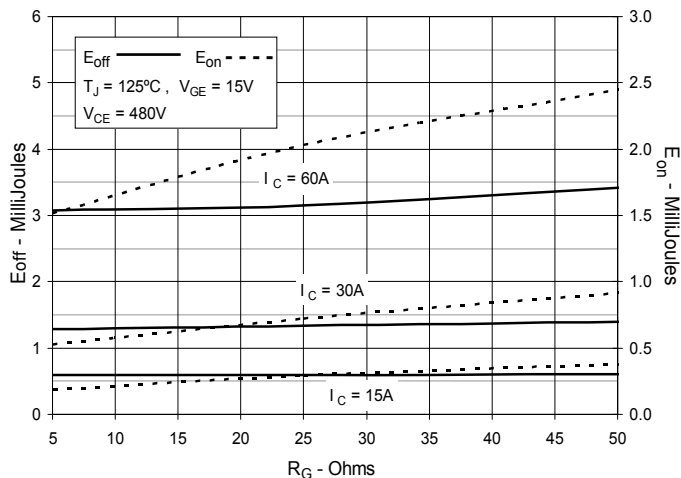
**Fig. 5. Collector-to-Emitter Voltage  
vs. Gate-to-Emitter Voltage**

**Fig. 6. Input Admittance**

**Fig. 7. Transconductance**

**Fig. 8. Gate Charge**

**Fig. 9. Capacitance**

**Fig. 10. Reverse-Bias Safe Operating Area**

**Fig. 11. Maximum Transient Thermal Impedance for IGBT**

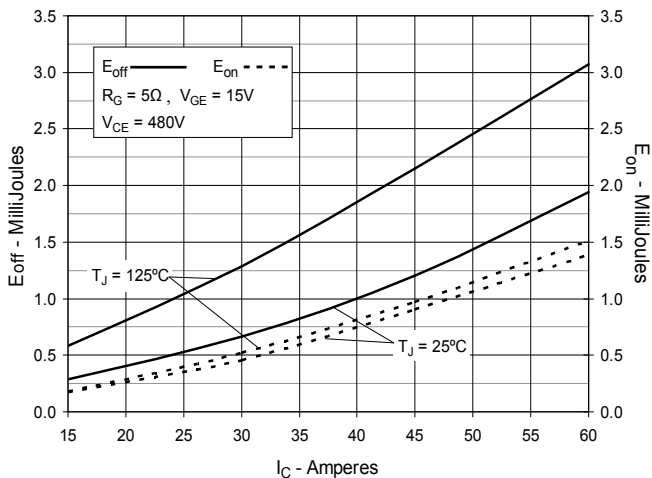
IXYS Reserves the Right to Change Limits, Test Conditions and Dimensions.

**Fig. 12. Inductive Switching  
Energy Loss vs. Gate Resistance**



**Fig. 13. Inductive Switching  
Energy Loss vs. Collector Current**



**Fig. 14. Inductive Switching  
Energy Loss vs. Junction Temperature**

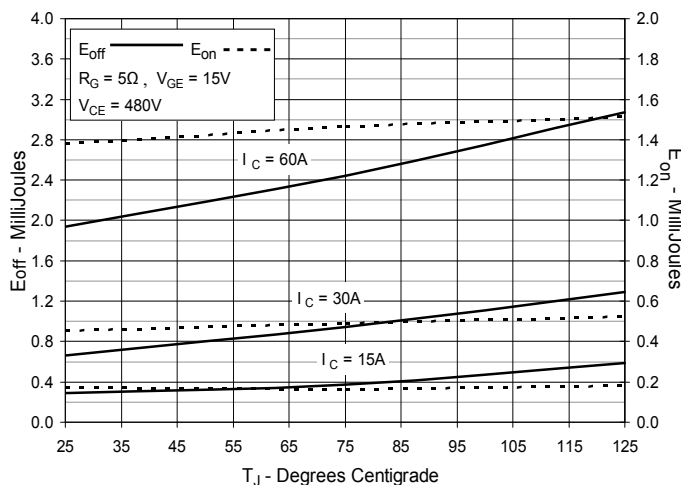

**Fig. 15. Inductive Turn-off  
Switching Times vs. Gate Resistance**

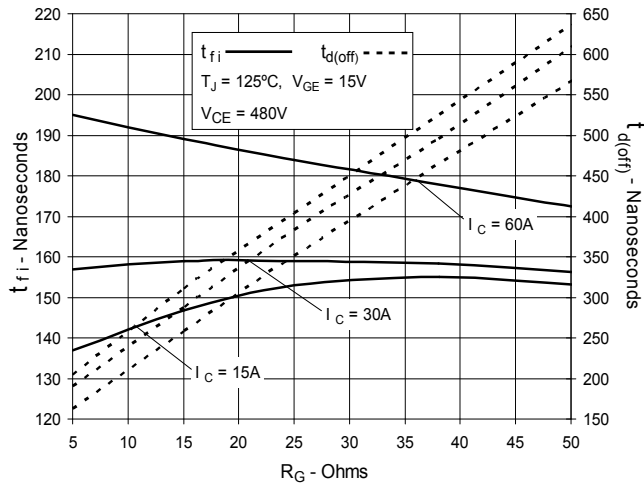

**Fig. 16. Inductive Turn-off  
Switching Times vs. Collector Current**

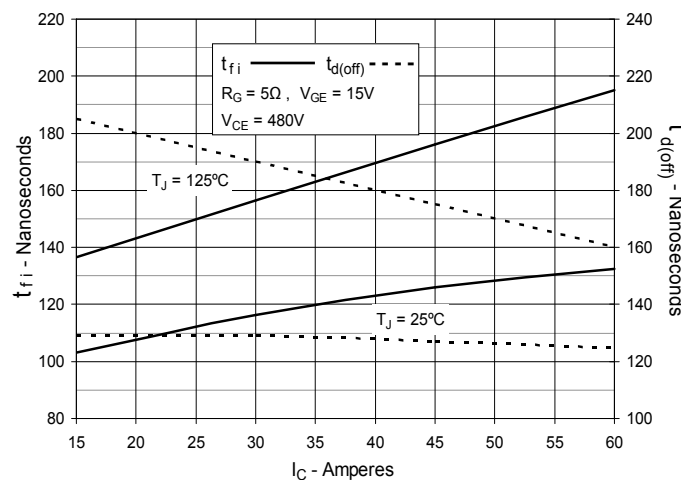

**Fig. 17. Inductive Turn-off  
Switching Times vs. Junction Temperature**

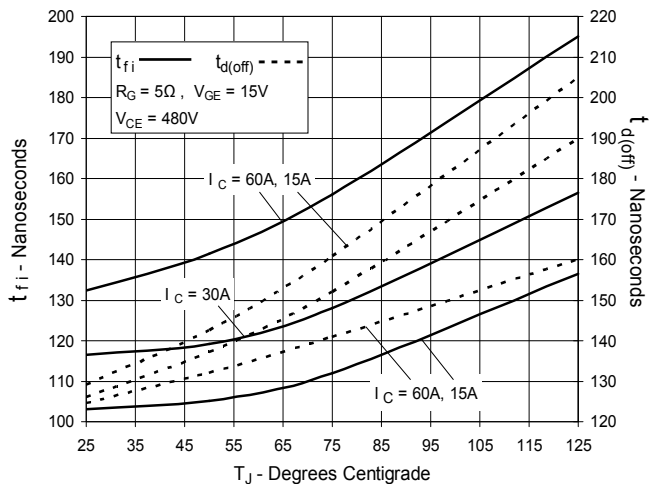

**Fig. 18. Inductive Turn-on  
Switching Times vs. Gate Resistance**

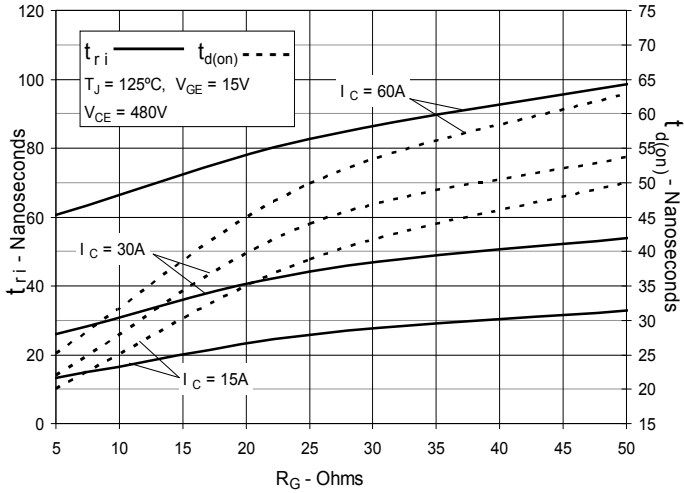

**Fig. 19. Inductive Turn-on  
Switching Times vs. Collector Current**

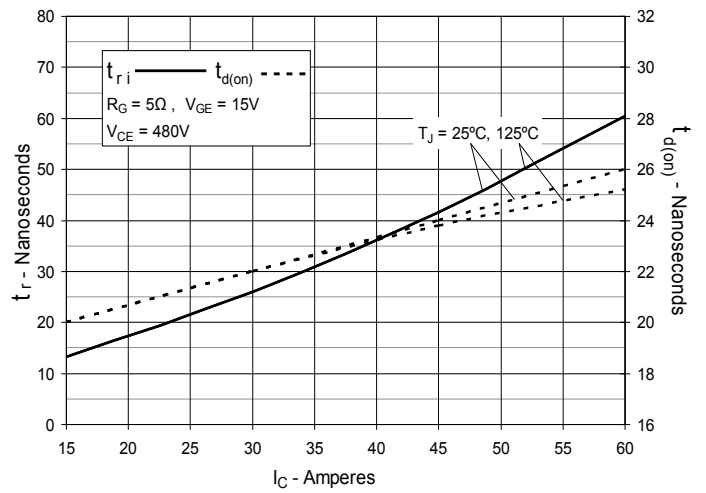

**Fig. 20. Inductive Turn-on  
Switching Times vs. Junction Temperature**

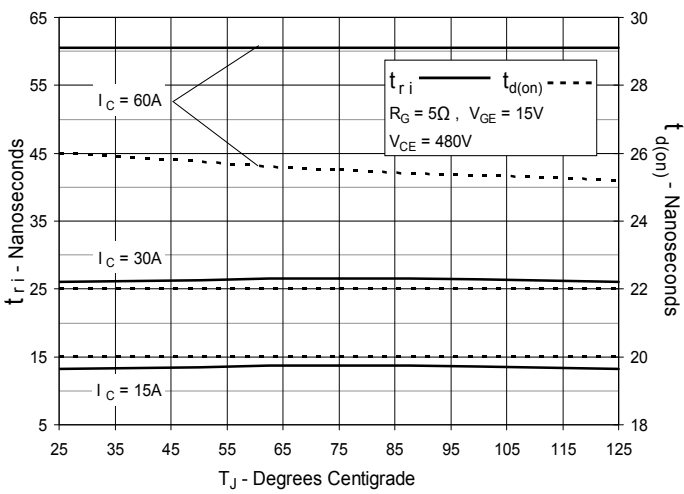

**Fig. 21. Forward Current vs. Forward Voltage**

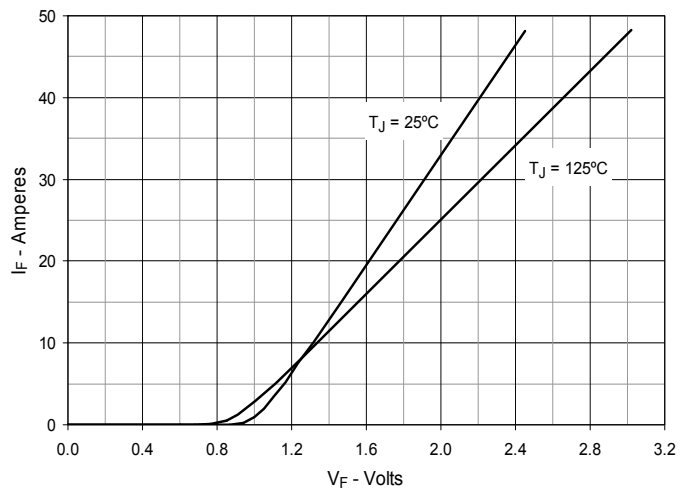

**Fig. 22. Maximum Transient Thermal Impedance for Diodes**

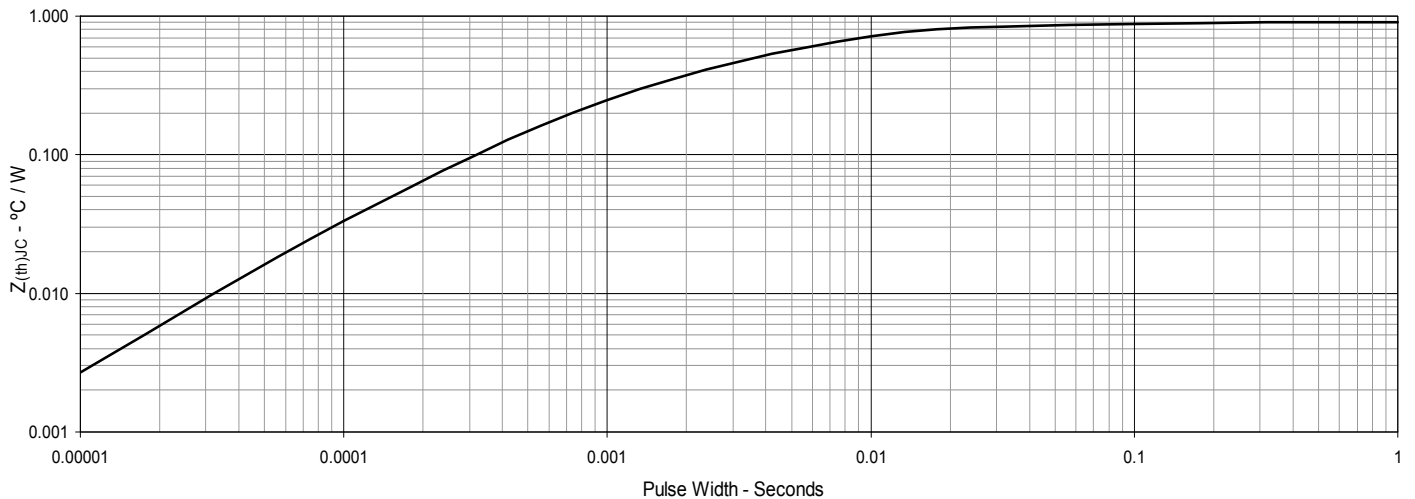

IXYS Reserves the Right to Change Limits, Test Conditions and Dimensions.



---

Disclaimer Notice - Information furnished is believed to be accurate and reliable. However, users should independently evaluate the suitability of and test each product selected for their own applications. Littelfuse products are not designed for, and may not be used in, all applications. Read complete Disclaimer Notice at [www.littelfuse.com/disclaimer-electronics](http://www.littelfuse.com/disclaimer-electronics).

## Looking for pricing, stock, or lifecycle information?

Click below to explore more details on WIN SOURCE:

 [View IXGH48N60B3C1 on WIN SOURCE](#)

 [IXYS Information](#)

## Optimize Your Supply Chain with WIN SOURCE Solutions

-  Global Sourcing Solution
-  Obsolete Management
-  Cost Control Management
-  Shortage Management
-  Alternative Solution
-  Excess Inventory Management