



**THE DATASHEET OF  
IXGH31N60D1**



# Ultra-Low $V_{CE(sat)}$ IGBT with Diode

# IXGH 31N60D1 IXGT 31N60D1

$V_{CES} = 600\text{ V}$   
 $I_{C25} = 60\text{ A}$   
 $V_{CE(sat)} = 1.7\text{ V}$

Preliminary data

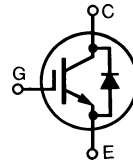

Symbol	Test Conditions	Maximum Ratings	
$V_{CES}$	$T_J = 25^\circ\text{C}$ to $150^\circ\text{C}$	600	V
$V_{CGR}$	$T_J = 25^\circ\text{C}$ to $150^\circ\text{C}$ ; $R_{GE} = 1\text{ M}\Omega$	600	V
$V_{GES}$	Continuous	$\pm 20$	V
$V_{GEM}$	Transient	$\pm 30$	V
$I_{C25}$	$T_C = 25^\circ\text{C}$	60	A
$I_{C90}$	$T_C = 90^\circ\text{C}$	31	A
$I_{CM}$	$T_C = 25^\circ\text{C}$ , 1 ms	80	A
<b>SSOA (RBSOA)</b>	$V_{GE} = 15\text{ V}$ , $T_{VJ} = 125^\circ\text{C}$ , $R_G = 10\ \Omega$ Clamped inductive load, $L = 100\ \mu\text{H}$	$I_{CM} = 62$ @ $0.8 V_{CES}$	A
$P_C$	$T_C = 25^\circ\text{C}$	150	W
$T_J$		-55 ... +150	$^\circ\text{C}$
$T_{JM}$		150	$^\circ\text{C}$
$T_{stg}$		-55 ... +150	$^\circ\text{C}$
$M_d$	Mounting torque (M3) TO-247	1.13/10	Nm/lb.in.
Maximum lead temperature for soldering 1.6 mm (0.062 in.) from case for 10 s		300	$^\circ\text{C}$
<b>Weight</b>	TO-247	6	g
	TO-268	4	g

TO-268  
(IXGT)

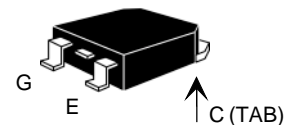

TO-247 AD  
(IXGH)

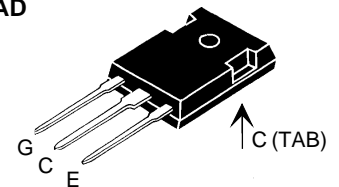

G = Gate, C = Collector,  
E = Emitter, TAB = Collector

### Features

- IGBT and anti-parallel FRED in one package
- Low  $V_{CE(sat)}$ 
  - for minimum on-state conduction losses
- MOS Gate turn-on
  - drive simplicity
- Fast Recovery Epitaxial Diode (FRED)
  - soft recovery with low  $I_{RM}$

### Applications

- AC motor speed control
- DC servo and robot drives
- DC choppers
- Uninterruptible power supplies (UPS)
- Switch-mode and resonant-mode power supplies

### Advantages

- Space savings (two devices in one package)
- Easy to mount with 1 screw (isolated mounting screw hole)
- Reduces assembly time and cost
- High power density

Symbol	Test Conditions	Characteristic Values ( $T_J = 25^\circ\text{C}$ , unless otherwise specified)		
		min.	typ.	max.
$BV_{CES}$	$I_C = 250\ \mu\text{A}$ , $V_{GE} = 0\text{ V}$	600		V
$V_{GE(th)}$	$I_C = 250\ \mu\text{A}$ , $V_{CE} = V_{GE}$	2.5		V
$I_{CES}$	$V_{CE} = 0.8 \cdot V_{CES}$ $V_{GE} = 0\text{ V}$	$T_J = 25^\circ\text{C}$		200 $\mu\text{A}$
		$T_J = 125^\circ\text{C}$		3 mA
$I_{GES}$	$V_{CE} = 0\text{ V}$ , $V_{GE} = \pm 20\text{ V}$			$\pm 100\text{ nA}$
$V_{CE(sat)}$	$I_C = I_{C90}$ , $V_{GE} = 15\text{ V}$			1.7 V

Symbol	Test Conditions	Characteristic Values ( $T_J = 25^\circ\text{C}$ , unless otherwise specified)		
		min.	typ.	max.
$g_{fs}$	$I_C = I_{C90}$ ; $V_{CE} = 10\text{ V}$ , Pulse test, $t \leq 300\ \mu\text{s}$ , duty cycle $\leq 2\%$	10	16	S
$C_{ies}$	$V_{CE} = 25\text{ V}$ , $V_{GE} = 0\text{ V}$ , $f = 1\text{ MHz}$		1500	pF
$C_{oes}$			130	pF
$C_{res}$			40	pF
$Q_g$	$I_C = I_{C90}$ , $V_{GE} = 15\text{ V}$ , $V_{CE} = 0.5 V_{CES}$		80	100 nC
$Q_{ge}$			15	30 nC
$Q_{gc}$			30	40 nC
$t_{d(on)}$	<b>Inductive load, <math>T_J = 25^\circ\text{C}</math></b> $I_C = I_{C90}$ , $V_{GE} = 15\text{ V}$ , $L = 100\ \mu\text{H}$ , $V_{CE} = 0.8 V_{CES}$ , $R_G = R_{off} = 10\ \Omega$ Remarks: Switching times may increase for $V_{CE}(\text{Clamp}) > 0.8 \cdot V_{CES}$ , higher $T_J$ or increased $R_G$		15	ns
$t_{ri}$			25	ns
$t_{d(off)}$			400	800 ns
$t_{fi}$			400	800 ns
$E_{off}$			6	mJ
$t_{d(on)}$	<b>Inductive load, <math>T_J = 125^\circ\text{C}</math></b> $I_C = I_{C90}$ , $V_{GE} = 15\text{ V}$ , $L = 100\ \mu\text{H}$ $V_{CE} = 0.8 V_{CES}$ , $R_G = R_{off} = 10\ \Omega$ Remarks: Switching times may increase for $V_{CE}(\text{Clamp}) > 0.8 \cdot V_{CES}$ , higher $T_J$ or increased $R_G$		15	ns
$t_{ri}$			25	ns
$E_{on}$			1	mJ
$t_{d(off)}$			800	ns
$t_{fi}$			800	ns
$E_{off}$			12	mJ
$R_{thJC}$				0.83 K/W
$R_{thCK}$				0.25 K/W

Symbol	Test Conditions	Characteristic Values ( $T_J = 25^\circ\text{C}$ , unless otherwise specified)		
		min.	typ.	max.
$V_F$	$I_F = I_{C90}$ , $V_{GE} = 0\text{ V}$ , Pulse test, $t \leq 300\ \mu\text{s}$ , duty cycle $d \leq 2\%$	$T_J = 150^\circ\text{C}$		1.6 V
		$T_J = 25^\circ\text{C}$		2.5 V
$I_{RM}$	$I_F = I_{C90}$ , $V_{GE} = 0\text{ V}$ , $-di_F/dt = 100\text{ A}/\mu\text{s}$ $V_R = 100\text{ V}$ $I_F = 1\text{ A}$ ; $-di/dt = 100\text{ A}/\mu\text{s}$ ; $V_R = 30\text{ V}$	$T_J = 100^\circ\text{C}$		6 A
$t_{rr}$		$T_J = 25^\circ\text{C}$		100 ns
				25 ns
$R_{thJC}$				1 K/W

### Min. Recommended Footprint

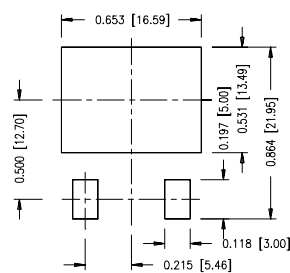

### TO-247 AD (IXGH) Outline

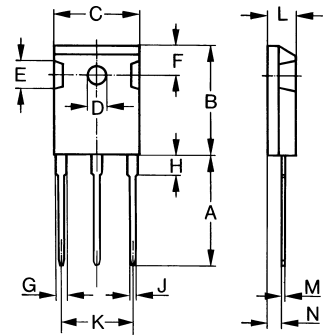

Dim.	Millimeter		Inches	
	Min.	Max.	Min.	Max.
A	19.81	20.32	0.780	0.800
B	20.80	21.46	0.819	0.845
C	15.75	16.26	0.610	0.640
D	3.55	3.65	0.140	0.144
E	4.32	5.49	0.170	0.216
F	5.4	6.2	0.212	0.244
G	1.65	2.13	0.065	0.084
H	-	4.5	-	0.177
J	1.0	1.4	0.040	0.055
K	10.8	11.0	0.426	0.433
L	4.7	5.3	0.185	0.209
M	0.4	0.8	0.016	0.031
N	1.5	2.49	0.087	0.102

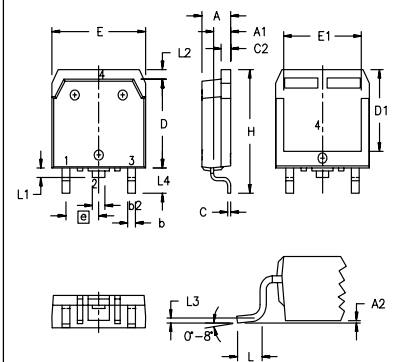

### TO-268AA (D<sup>3</sup> PAK)



Dim.	Millimeter		Inches	
	Min.	Max.	Min.	Max.
A	4.9	5.1	.193	.201
A <sub>1</sub>	2.7	2.9	.106	.114
A <sub>2</sub>	.02	.25	.001	.010
b	1.15	1.45	.045	.057
b <sub>2</sub>	1.9	2.1	.75	.83
C	.4	.65	.016	.026
D	13.80	14.00	.543	.551
E	15.85	16.05	.624	.632
E <sub>1</sub>	13.3	13.6	.524	.535
e	5.45 BSC		.215 BSC	
H	18.70	19.10	.736	.752
L	2.40	2.70	.094	.106
L <sub>1</sub>	1.20	1.40	.047	.055
L <sub>2</sub>	1.00	1.15	.039	.045
L <sub>3</sub>	0.25 BSC		.010 BSC	
L <sub>4</sub>	3.80	4.10	.150	.161

## Looking for pricing, stock, or lifecycle information?

Click below to explore more details on WIN SOURCE:

-  [View IXGH31N60D1 on WIN SOURCE](#)
-  [IXYS Information](#)

## Optimize Your Supply Chain with WIN SOURCE Solutions

-  Global Sourcing Solution
-  Obsolete Management
-  Cost Control Management
-  Shortage Management
-  Alternative Solution
-  Excess Inventory Management