



**THE DATASHEET OF  
IXGH15N120B2D1**



# HiPerFAST™ IGBT IXGH15N120B2D1 IXGT15N120B2D1

Optimized for 10-20 KHz hard switching and up to 100 KHz resonant switching

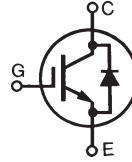

$$\begin{aligned} V_{CES} &= 1200 \text{ V} \\ I_{C25} &= 30 \text{ A} \\ V_{CE(sat)} &= 3.3 \text{ V} \\ t_{fi(typ)} &= 137 \text{ ns} \end{aligned}$$

Symbol	Test Conditions	Maximum Ratings	
$V_{CES}$	$T_J = 25^\circ\text{C}$ to $150^\circ\text{C}$	1200	V
$V_{CGR}$	$T_J = 25^\circ\text{C}$ to $150^\circ\text{C}$ ; $R_{GE} = 1 \text{ M}\Omega$	1200	V
$V_{GES}$	Continuous	$\pm 20$	V
$V_{GEM}$	Transient	$\pm 30$	V
$I_{C25}$	$T_C = 25^\circ\text{C}$	30	A
$I_{C90}$	$T_C = 90^\circ\text{C}$	15	A
$I_{CM}$	$T_C = 25^\circ\text{C}$ , 1 ms	60	A
<b>SSOA</b> <b>(RBSOA)</b>	$V_{GE} = 15 \text{ V}$ , $T_{VJ} = 125^\circ\text{C}$ , $R_G = 10 \Omega$ Clamped inductive load	$I_{CM} = 40$ @ $0.8 V_{CES}$	A
$P_C$	$T_C = 25^\circ\text{C}$	192	W
$T_J$		-55 ... +150	$^\circ\text{C}$
$T_{JM}$		150	$^\circ\text{C}$
$T_{stg}$		-55 ... +150	$^\circ\text{C}$
$M_d$	Mounting torque (TO-247)	1.13/10 Nm/lb.in.	
Maximum lead temperature for soldering 1.6 mm (0.062 in.) from case for 10 s		300	$^\circ\text{C}$
Maximum tab temperature soldering SMD devices for 10s		260	$^\circ\text{C}$
<b>Weight</b>	TO-247AD / TO-268	6 / 4	g

TO-247AD  
(IXGH)

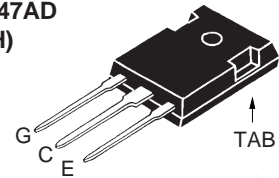

TO-268  
(IXGT)

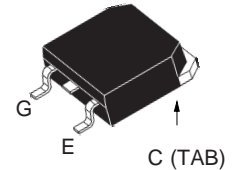

G = Gate      C = Collector  
E = Emitter    TAB = Collector

### Features

- International standard packages: JEDEC TO-247AD & TO-268
- IGBT and anti-parallel FRED in one package
- MOS Gate turn-on
  - drive simplicity
- Fast Recovery Exptaxial Diode (FRED)
  - soft recovery with low  $I_{RM}$

### Applications

- AC motor speed control
- DC servo and robot drives
- DC choppers
- Uninterruptible power supplies (UPS)
- Switch-mode and resonant-mode power supplies

### Advantages

- Saves space (two devices in one package)
- Easy to mount with 1 screw (isolated mounting screw hole)
- Reduces assembly time and cost

Symbol	Test Conditions ( $T_J = 25^\circ\text{C}$ , unless otherwise specified)	Characteristic Values		
		Min.	Typ.	Max.
$BV_{CES}$	$I_C = 250 \mu\text{A}$ , $V_{GE} = 0 \text{ V}$	1200		V
$V_{GE(th)}$	$I_C = 250 \mu\text{A}$ , $V_{CE} = V_{GE}$	2.5		V
$I_{CES}$	$V_{CE} = V_{CES}$ $V_{GE} = 0 \text{ V}$	$T_J = 25^\circ\text{C}$		100 $\mu\text{A}$
		$T_J = 125^\circ\text{C}$		3.5 mA
$I_{GES}$	$V_{CE} = 0 \text{ V}$ , $V_{GE} = \pm 20 \text{ V}$			$\pm 100 \text{ nA}$
$V_{CE(sat)}$	$I_C = I_{CE90}$ , $V_{GE} = 15$	$T_J = 125^\circ\text{C}$		3.3 V
			2.7	V

Symbol	Test Conditions ( $T_J = 25^\circ\text{C}$ , unless otherwise specified)	Characteristic Values			
		Min.	Typ.	Max.	
$g_{fs}$	$I_C = I_{C90}, V_{CE} = 10\text{ V}$ , Pulse test, $t \leq 300\ \mu\text{s}$ , duty cycle $\leq 2\%$	12	15	S	
$C_{ies}$	$V_{CE} = 25\text{ V}, V_{GE} = 0\text{ V}, f = 1\text{ MHz}$		1700	pF	
$C_{oes}$			95	pF	
$C_{res}$			38	pF	
$Q_g$	$I_C = I_{C90}, V_{GE} = 15\text{ V}, V_{CE} = 0.5 V_{CES}$		86	nC	
$Q_{ge}$			13	nC	
$Q_{gc}$			26	nC	
$t_{d(on)}$	<b>Inductive load, <math>T_J = 25^\circ\text{C}</math></b> $I_C = I_{C90}, V_{GE} = 15\text{ V}$ $V_{CE} = 960\text{ V}, R_G = R_{off} = 10\ \Omega$ Remarks: Switching times may increase for $V_{CE}(\text{Clamp}) > 0.8 V_{CES}$ , higher $T_J$ or increased $R_G$		25	ns	
$t_{ri}$			15	ns	
$t_{d(off)}$			165	240	ns
$t_{fi}$			137	255	ns
$E_{off}$			1.4	2.3	mJ
$t_{d(on)}$	<b>Inductive load, <math>T_J = 125^\circ\text{C}</math></b> $I_C = I_{C90}, V_{GE} = 15\text{ V}$ $V_{CE} = 960\text{ V}, R_G = R_{off} = 10\ \Omega$ Remarks: Switching times may increase for $V_{CE}(\text{Clamp}) > 0.8 V_{CES}$ , higher $T_J$ or increased $R_G$		25	ns	
$t_{ri}$			18	ns	
$E_{on}$			0.60	mJ	
$t_{d(off)}$			260	ns	
$t_{fi}$			305	ns	
$E_{off}$			2.8	mJ	
$R_{thJC}$	TO-247			0.65	KW
$R_{thCK}$			0.25		KW

### Reverse Diode (FRED)

Symbol	Test Conditions	Characteristic Values ( $T_J = 25^\circ\text{C}$ , unless otherwise specified)			
		min.	typ.	max.	
$I_F$	$T_C = 100^\circ\text{C}$			15	A
$V_F$	$I_F = 15\text{ A}, V_{GE} = 0\text{ V}$ $I_F = 15\text{ A}, V_{GE} = 0\text{ V}, T_J = 125^\circ\text{C}$		2.1	2.8	V
$I_{RM}$	$I_F = 25\text{ A}; -di_F/dt = 100\text{ A}/\mu\text{s}, V_R = 100\text{ V}$ $V_{GE} = 0\text{ V}; T_J = 100^\circ\text{C}$		6		A
$t_{rr}$			165		ns
$R_{thJC}$				1.6	KW

### TO-247 AD Outline

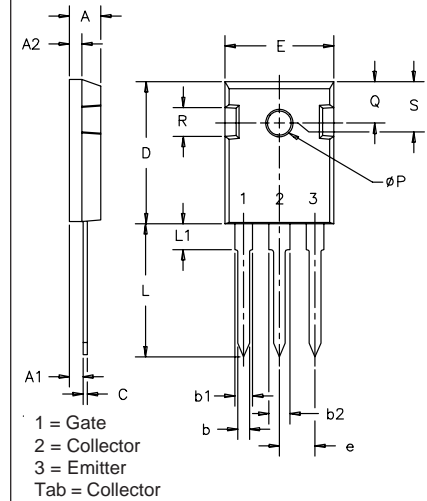

SYM	INCHES		MILLIMETERS	
	MIN	MAX	MIN	MAX
A	.185	.209	4.7	5.3
A1	.087	.102	2.2	2.54
A2	.059	.098	2.2	2.6
b	.040	.055	1.0	1.4
b1	.065	.084	1.65	2.13
b2	.113	.123	2.87	3.12
C	.016	.031	.4	.8
D	.819	.845	20.80	21.46
E	.610	.640	15.75	16.26
e	.215 BSC		5.45 BSC	
L	.780	.800	19.81	20.32
L1		.177		4.50
$\phi P$	.140	.144	3.55	3.65
Q	.212	.244	5.4	6.2
R	.170	.216	4.32	5.49
S	.242 BSC		6.15 BSC	

### TO-268 Outline

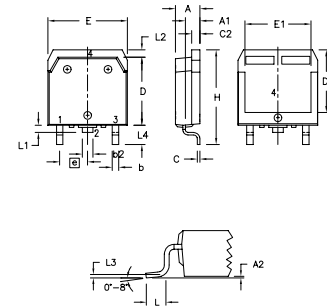

Dim.	Millimeter		Inches	
	Min.	Max.	Min.	Max.
A	4.9	5.1	.193	.201
A1	2.7	2.9	.106	.114
A2	.02	.25	.001	.010
b	1.15	1.45	.045	.057
b2	1.9	2.1	.75	.83
C	.4	.65	.016	.026
D	13.80	14.00	.543	.551
E	15.85	16.05	.624	.632
E1	13.3	13.6	.524	.535
e	5.45 BSC		.215 BSC	
H	18.70	19.10	.736	.752
L	2.40	2.70	.094	.106
L1	1.20	1.40	.047	.055
L2	1.00	1.15	.039	.045
L3	0.25 BSC		.010 BSC	
L4	3.80	4.10	.150	.161

IXYS reserves the right to change limits, test conditions, and dimensions.



---

Disclaimer Notice - Information furnished is believed to be accurate and reliable. However, users should independently evaluate the suitability of and test each product selected for their own applications. Littelfuse products are not designed for, and may not be used in, all applications. Read complete Disclaimer Notice at [www.littelfuse.com/disclaimer-electronics](http://www.littelfuse.com/disclaimer-electronics).







## Looking for pricing, stock, or lifecycle information?

Click below to explore more details on WIN SOURCE:

 [View IXGH15N120B2D1 on WIN SOURCE](#)

 [IXYS Information](#)

## Optimize Your Supply Chain with WIN SOURCE Solutions

-  Global Sourcing Solution
-  Obsolete Management
-  Cost Control Management
-  Shortage Management
-  Alternative Solution
-  Excess Inventory Management