



**THE DATASHEET OF
SM36-02HTG**



SM Series 400W TVS Diode Array



Pinout and Functional Block Diagram

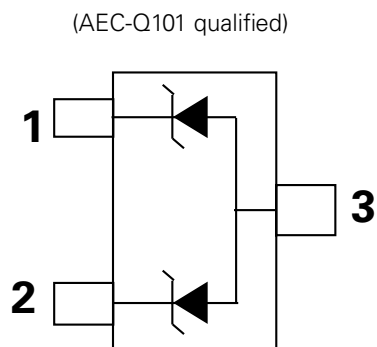

Life Support Note:

Not Intended for Use in Life Support or Life Saving Applications

The products shown herein are not designed for use in life sustaining or life saving applications unless otherwise expressly indicated.

Description

The SM series TVS Diode Array is designed to protect sensitive equipment from damage due to electrostatic discharge (ESD), electrical fast transients (EFT), and lightning induced surges.

The SM series can absorb repetitive ESD strikes above the maximum level specified in the IEC 61000-4-2 international standard without performance degradation and safely dissipate up to 24A of 8/20µs induced surge current (IEC-61000-4-5, 2nd Edition) with very low clamping voltages.

Features

- RoHS compliant and lead-free
- ESD, IEC 61000-4-2, ±30kV contact, ±30kV air
- EFT, IEC 61000-4-4, 50A (5/50ns)
- Lightning, IEC 61000-4-5, 2nd Edition, 24A ($t_p=8/20\mu s$, SM05)
- Working voltages: 5V, 12V, 15V, 24V and 36V
- Low clamping voltage
- Low leakage current
- AEC-Q101 qualified (SOT23-3 package)
- Moisture Sensitivity Level (MSL-1)

Applications

- Industrial Equipment
- Test and Medical Equipment
- Point-of-Sale Terminals
- Motor Controls
- Legacy Ports (RS-232, RS-485)
- Security and Alarm System
- Automotive Electronics

Additional Information



Datasheet



Resources



Samples

RS-232 Application Example

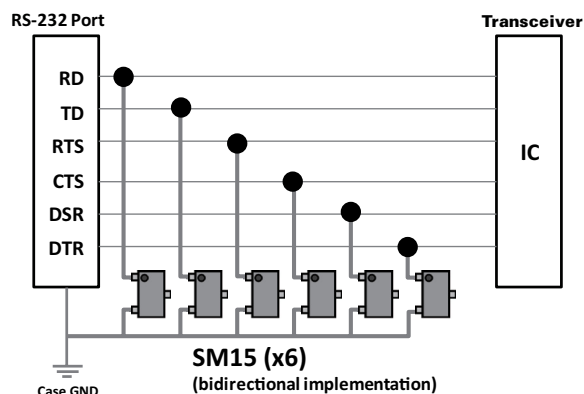

Absolute Maximum Ratings

Symbol	Parameter	Value	Units
P_{PK}	Peak Pulse Power ($t_p=8/20\mu s$)	400	W
T_{OP}	Operating Temperature	-40 to 125	°C
T_{STOR}	Storage Temperature	-55 to 150	°C

Notes:

CAUTION: Stresses above those listed in "Absolute Maximum Ratings" may cause permanent damage to the component. This is a stress only rating and operation of the component at these or any other conditions above those indicated in the operational sections of this specification is not implied.

SM05 Electrical Characteristics ($T_{OP}=25^\circ C$)

Parameter	Symbol	Test Conditions	Min	Typ	Max	Units
Reverse Standoff Voltage	V_{RWM}	$I_R \leq 1\mu A$			5.0	V
Reverse Voltage Drop	V_R	$I_R = 1mA$	6.0			V
Leakage Current	I_{LEAK}	$V_R = 5V$			1.0	μA
Clamp Voltage ¹	V_C	$I_{PP} = 1A, t_p = 8/20\mu s$, Pin 1 or Pin 2 to Pin 3			9.8	V
		$I_{PP} = 10A, t_p = 8/20\mu s$, Pin 1 or Pin 2 to Pin 3			13.0	V
Dynamic Resistance ²	R_{DYN}	TLP, $t_p = 100ns$, I/O to GND		0.19		Ω
Peak Pulse Current (8/20 μs) ¹	I_{pp}	$t_p = 8/20\mu s$			24.0	A
ESD Withstand Voltage ¹	V_{ESD}	IEC 61000-4-2 (Contact Discharge)	± 30			kV
		IEC 61000-4-2 (Air Discharge)	± 30			kV
Diode Capacitance ¹	$C_{I/O-GND}$	Reverse Bias=0V, f=1MHz			400	pF
	$C_{I/O-I/O}$	Reverse Bias=0V, f=1MHz			350	pF

SM12 Electrical Characteristics ($T_{OP}=25^\circ C$)

Parameter	Symbol	Test Conditions	Min	Typ	Max	Units
Reverse Standoff Voltage	V_{RWM}	$I_R \leq 1\mu A$			12.0	V
Reverse Voltage Drop	V_R	$I_R = 1mA$	13.3			V
Leakage Current	I_{LEAK}	$V_R = 12V$			1.0	μA
Clamp Voltage ¹	V_C	$I_{PP} = 1A, t_p = 8/20\mu s$, Pin 1 or Pin 2 to Pin 3			18.5	V
		$I_{PP} = 10A, t_p = 8/20\mu s$, Pin 1 or Pin 2 to Pin 3			22.5	V
Dynamic Resistance ²	R_{DYN}	TLP, $t_p = 100ns$, I/O to GND		0.25		Ω
Peak Pulse Current (8/20 μs) ¹	I_{pp}	$t_p = 8/20\mu s$			17.0	A
ESD Withstand Voltage ¹	V_{ESD}	IEC 61000-4-2 (Contact Discharge)	± 30			kV
		IEC 61000-4-2 (Air Discharge)	± 30			kV
Diode Capacitance ¹	$C_{I/O-GND}$	Reverse Bias=0V, f=1MHz			150	pF
	$C_{I/O-I/O}$	Reverse Bias=0V, f=1MHz			120	pF

SM15 Electrical Characteristics (T_{OP}=25°C)

Parameter	Symbol	Test Conditions	Min	Typ	Max	Units
Reverse Standoff Voltage	V _{RWM}	I _R ≤ 1 μA			15.0	V
Reverse Voltage Drop	V _R	I _R = 1 mA	16.7			V
Leakage Current	I _{LEAK}	V _R = 15V			1.0	μA
Clamp Voltage ¹	V _C	I _{PP} = 1A, t _p = 8/20μs, Pin 1 or Pin 2 to Pin 3			24.0	V
		I _{PP} = 10A, t _p = 8/20μs, Pin 1 or Pin 2 to Pin 3			30.0	V
Dynamic Resistance ²	R _{DYN}	TLP, t _p = 100ns, I/O to GND		0.30		Ω
Peak Pulse Current (8/20μs) ¹	I _{pp}	t _p = 8/20μs			12.0	A
ESD Withstand Voltage ¹	V _{ESD}	IEC 61000-4-2 (Contact Discharge)	±30			kV
		IEC 61000-4-2 (Air Discharge)	±30			kV
Diode Capacitance ¹	C _{I/O-GND}	Reverse Bias=0V, f=1MHz			100	pF
	C _{I/O-I/O}	Reverse Bias=0V, f=1MHz			75	pF

SM24 Electrical Characteristics (T_{OP}=25°C)

Parameter	Symbol	Test Conditions	Min	Typ	Max	Units
Reverse Standoff Voltage	V _{RWM}	I _R ≤ 1 μA			24.0	V
Reverse Voltage Drop	V _R	I _R = 1 mA	26.7			V
Leakage Current	I _{LEAK}	V _R = 24V			1.0	μA
Clamp Voltage ¹	V _C	I _{PP} = 1A, t _p = 8/20μs, Pin 1 or Pin 2 to Pin 3			36.0	V
		I _{PP} = 5A, t _p = 8/20μs, Pin 1 or Pin 2 to Pin 3			42.0	V
Dynamic Resistance ²	R _{DYN}	TLP, t _p = 100ns, I/O to GND		0.50		Ω
Peak Pulse Current (8/20μs) ¹	I _{pp}	t _p = 8/20μs			7.0	A
ESD Withstand Voltage ¹	V _{ESD}	IEC 61000-4-2 (Contact Discharge)	±30			kV
		IEC 61000-4-2 (Air Discharge)	±30			kV
Diode Capacitance ¹	C _{I/O-GND}	Reverse Bias=0V, f=1MHz			65	pF
	C _{I/O-I/O}	Reverse Bias=0V, f=1MHz			50	pF

SM36 Electrical Characteristics (T_{OP}=25°C)

Parameter	Symbol	Test Conditions	Min	Typ	Max	Units
Reverse Standoff Voltage	V _{RWM}	I _R ≤ 1 μA			36.0	V
Reverse Voltage Drop	V _R	I _R = 1 mA	40.0			V
Leakage Current	I _{LEAK}	V _R = 36V			1.0	μA
Clamp Voltage ¹	V _C	I _{PP} = 1A, t _p = 8/20μs, Pin 1 or Pin 2 to Pin 3			52.0	V
		I _{PP} = 4A, t _p = 8/20μs, Pin 1 or Pin 2 to Pin 3			62.0	V
Dynamic Resistance ²	R _{DYN}	TLP, t _p = 100ns, I/O to GND		0.65		Ω
Peak Pulse Current (8/20μs) ¹	I _{pp}	t _p = 8/20μs			5.0	A
ESD Withstand Voltage ¹	V _{ESD}	IEC 61000-4-2 (Contact Discharge)	±30			kV
		IEC 61000-4-2 (Air Discharge)	±30			kV
Diode Capacitance ¹	C _{I/O-GND}	Reverse Bias=0V, f=1MHz			50	pF
	C _{I/O-I/O}	Reverse Bias=0V, f=1MHz			40	pF

Note:

¹ Parameter is guaranteed by design and/or component characterization.

² Transmission Line Pulse (TLP) with 100ns width and 200ps rise time.

Non-Repetitive Peak Pulse Power vs. Pulse Time

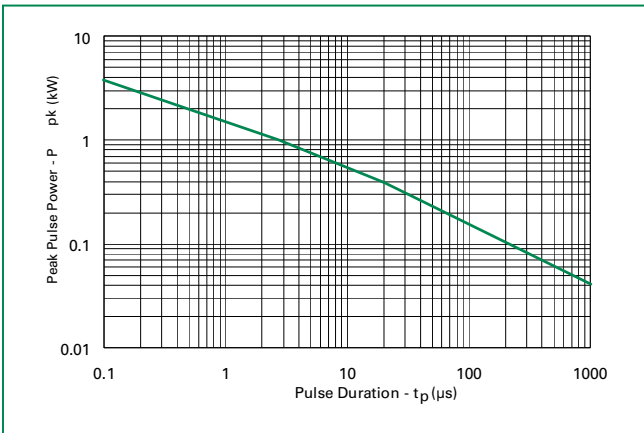

Power Derating Curve

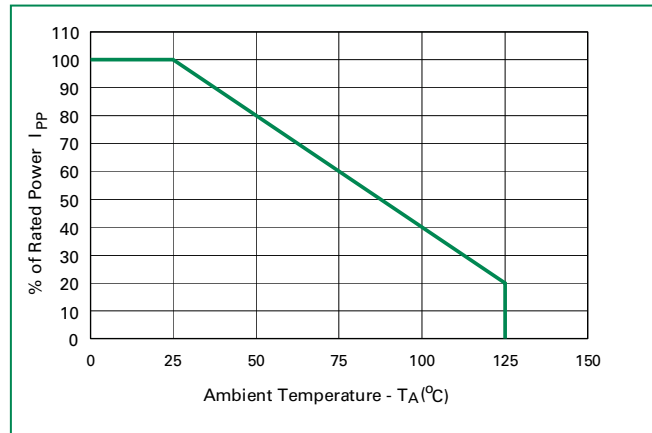

Pulse Waveform

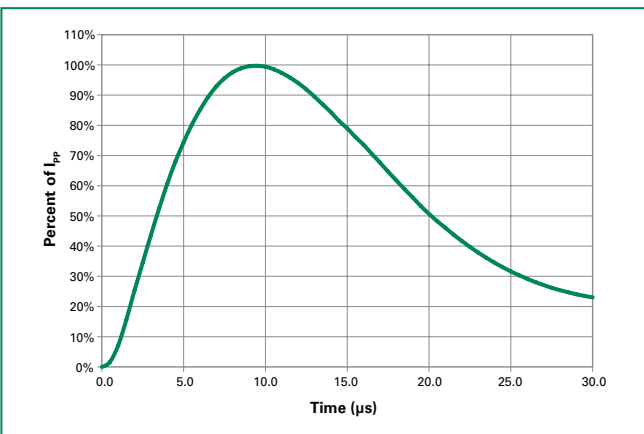

SM05 Transmission Line Pulsing(TLP) Plot

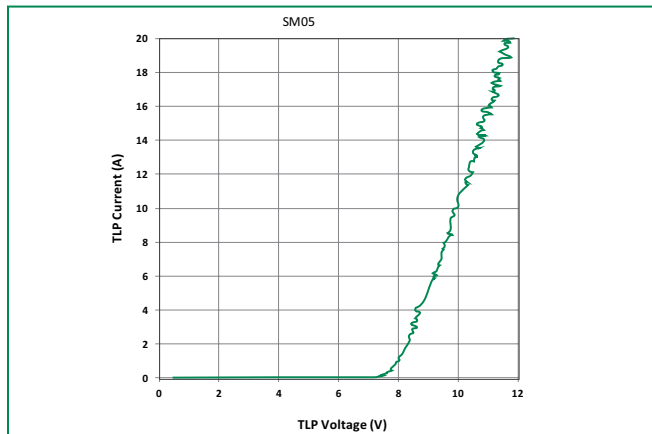

SM12 Transmission Line Pulsing(TLP) Plot

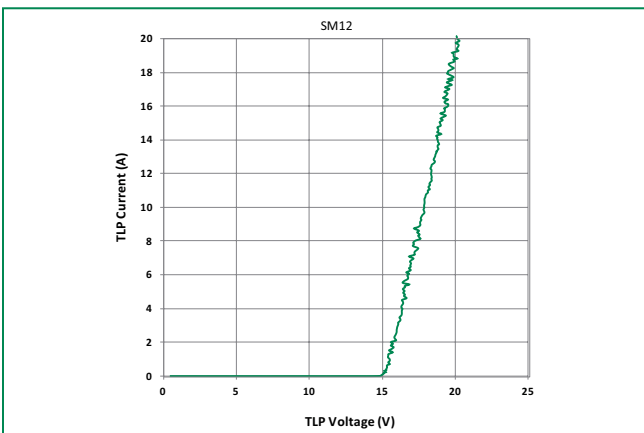

SM15 Transmission Line Pulsing(TLP) Plot

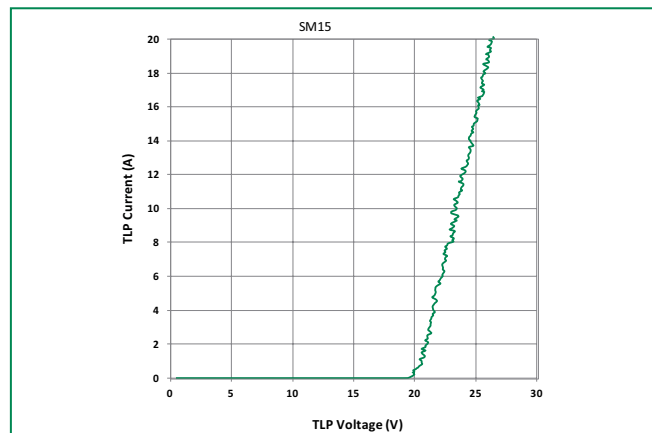

SM24 Transmission Line Pulsing(TLP) Plot

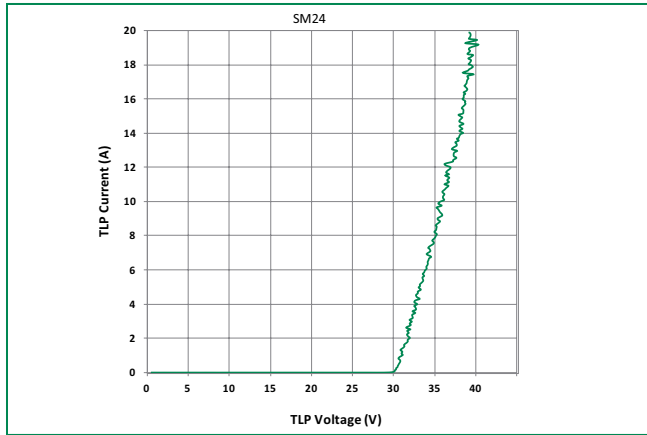

SM36 Transmission Line Pulsing(TLP) Plot

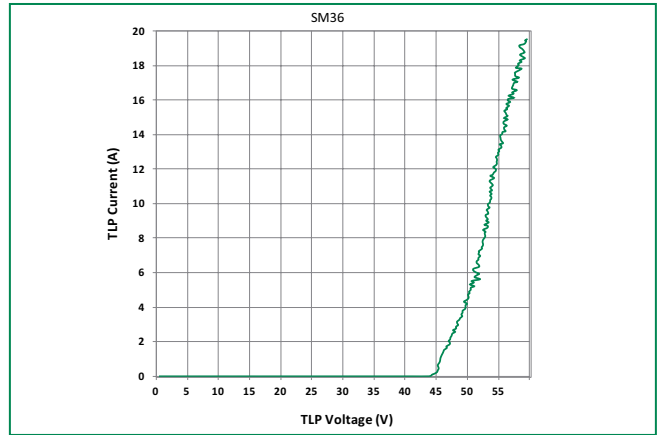

Soldering Parameters

Reflow Condition		Pb – Free assembly
Pre Heat	- Temperature Min ($T_{s(min)}$)	150°C
	- Temperature Max ($T_{s(max)}$)	200°C
	- Time (min to max) (t_s)	60 – 180 secs
Average ramp up rate (Liquidus) Temp (T_L) to peak		3°C/second max
$T_{s(max)}$ to T_L - Ramp-up Rate		3°C/second max
Reflow	- Temperature (T_L) (Liquidus)	217°C
	- Temperature (t_l)	60 – 150 seconds
Peak Temperature (T_p)		260 ^{+0/-5} °C
Time within 5°C of actual peak Temperature (t_p)		20 – 40 seconds
Ramp-down Rate		6°C/second max
Time 25°C to peak Temperature (T_p)		8 minutes Max.
Do not exceed		260°C

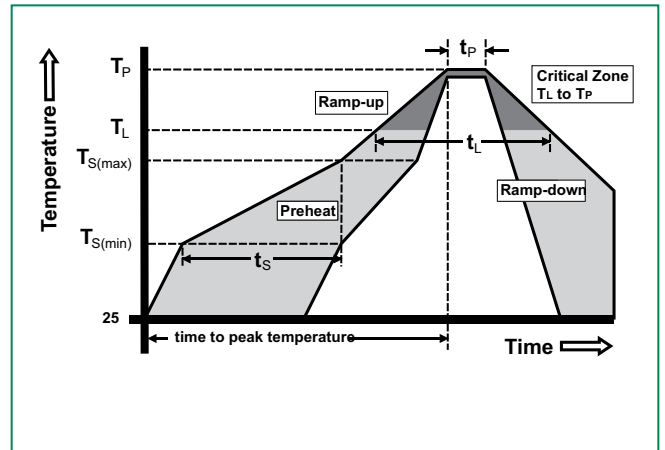

Ordering Information

Part Number	Package	Marking	Min. Order Qty.
SM05-02HTG	SOT23-3	M05	3000
SM12-02HTG	SOT23-3	M12	3000
SM15-02HTG	SOT23-3	M15	3000
SM24-02HTG	SOT23-3	M24	3000
SM36-02HTG	SOT23-3	M36	3000

Part Marking System

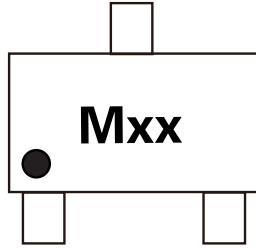

Part Numbering System

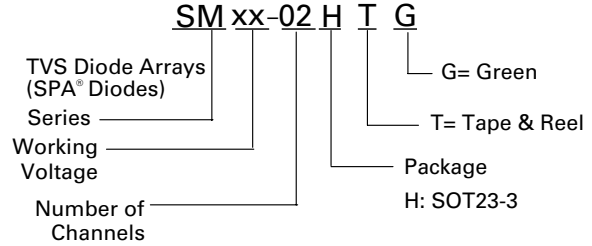

Package Dimensions – SOT23-3

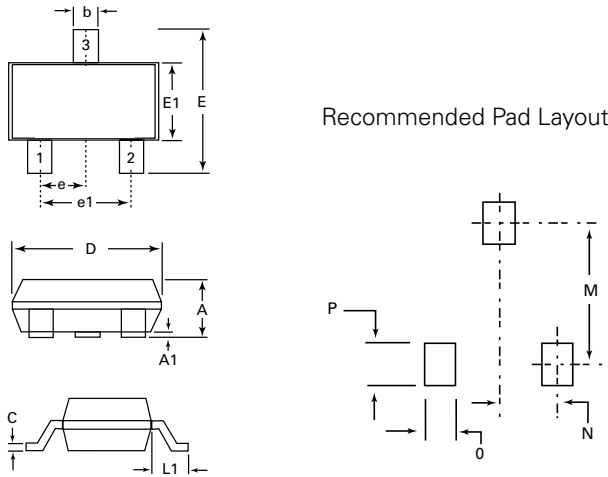

Package	SOT23-3			
Pins	3			
JEDEC	TO-236			
	Millimeters		Inches	
	Min	Max	Min	Max
A	0.89	1.12	0.035	0.044
A1	0.01	0.1	0.0004	0.004
b	0.3	0.5	0.012	0.020
c	0.08	0.2	0.003	0.008
D	2.8	3.04	0.110	0.120
E	2.1	2.64	0.083	0.104
E1	1.2	1.4	0.047	0.055
e	0.95 BSC		0.038 BSC	
e1	1.90 BSC		0.075 BSC	
L1	0.54 REF		0.021 REF	
M		2.29		.090
N		0.95		0.038
O		0.78		.030TYP
P		0.78		.030TYP

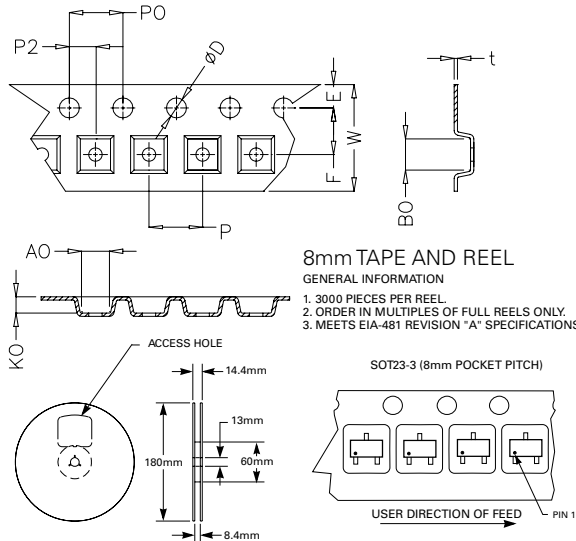

Embossed Carrier Tape & Reel Specification – SOT23-3



Symbol	Millimetres		Inches	
	Min	Max	Min	Max
E	1.65	1.85	0.065	0.073
F	3.40	3.60	0.134	0.142
P2	1.90	2.10	0.075	0.083
D	1.40	1.60	0.055	0.063
P0	3.90	4.10	0.154	0.161
W	7.70	8.30	0.303	0.327
P	3.90	4.10	0.154	0.161
A0	3.05	3.25	0.120	0.128
B0	2.67	2.87	0.105	0.113
K0	1.12	1.32	0.044	0.052
t	0.22	0.24	0.009	0.009

Looking for pricing, stock, or lifecycle information?

Click below to explore more details on WIN SOURCE:

-  [View SM36-02HTG on WIN SOURCE](#)
-  [Littelfuse Inc. Information](#)

Optimize Your Supply Chain with WIN SOURCE Solutions

-  Global Sourcing Solution
-  Obsolete Management
-  Cost Control Management
-  Shortage Management
-  Alternative Solution
-  Excess Inventory Management