



THE DATASHEET OF UFM15PL-TP





Micro Commercial Components



Micro Commercial Components
 20736 Marilla Street Chatsworth
 CA 91311
 Phone: (818) 701-4933
 Fax: (818) 701-4939

UFM11PL THRU UFM17PL

1 Amp Ultra Fast Recovery Silicon Rectifier 50 to 1000 Volts

Features

- Halogen free available upon request by adding suffix "-HF"
- Ultra fast Recovery
- High Reliability
- Epoxy meets UL 94 V-0 flammability rating
- Moisture Sensitivity Level 1
- Lead Free Finish/RoHS Compliant (Note1)("P" Suffix designates Compliant. See ordering information)

Maximum Ratings

- Operating Temperature: -65°C to +150°C
- Storage Temperature: -65°C to +150°C
- Maximum Thermal Resistance; 180°C/W Junction To Ambient.

MCC Part Number	Device Marking	Maximum Recurrent Peak Reverse Voltage	Maximum RMS Voltage	Maximum DC Blocking Voltage
UFM11PL	U1	50V	35V	50V
UFM12PL	U2	100V	70V	100V
UFM13PL	U3	200V	140V	200V
UFM14PL	U4	400V	280V	400V
UFM15PL	U5	600V	420V	600V
UFM16PL	U6	800V	560V	800V
UFM17PL	U7	1000V	700V	1000V

Electrical Characteristics @ 25°C Unless Otherwise Specified

Average Forward Current	$I_{F(AV)}$	1.0A	$T_L = 90^\circ\text{C}$
Peak Forward Surge Current	I_{FSM}	30A	8.3ms, half sine
Maximum Instantaneous Forward Voltage UFM11PL-13PL UFM14PL UFM15PL-17PL	V_F	1.0V 1.40V 1.70V	$I_{FM} = 1.0A$; $T_a = 25^\circ\text{C}$
Maximum DC Reverse Current At Rated DC Blocking Voltage	I_R	10 μ A 50 μ A	$T_a = 25^\circ\text{C}$ $T_a = 125^\circ\text{C}$
Maximum Reverse Recovery Time UFM11PL-13PL UFM14PL UFM15PL-16PL UFM17PL	T_{rr}	35ns 50ns 75ns 100ns	$I_F = 0.5A, I_R = 1.0A$, $I_{rr} = 0.25A$
Typical Junction Capacitance	C_J	20pF	Measured at 1.0MHz, $V_R = 4.0V$

Note: 1. High Temperature Solder Exemption Applied, see EU Directive Annex 7.

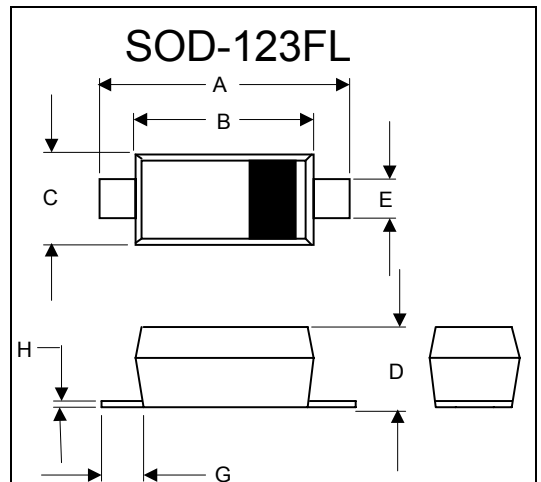

DIM	DIMENSIONS				NOTE
	INCHES		MM		
	MIN	MAX	MIN	MAX	
A	.140	.152	3.55	3.85	
B	.100	.122	2.55	3.10	
C	.055	.075	1.40	1.90	
D	.035	.053	0.90	1.35	
E	.020	.041	0.50	1.05	
G	.010	----	0.25	----	
H	----	.010	----	.25	

SUGGESTED SOLDER PAD LAYOUT

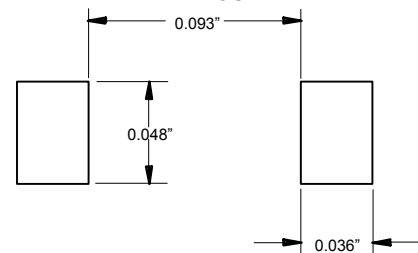

UFM11PL THRU UFM17PL

TYPICAL CHARACTERISTICS

Figure 1
Typical Forward Characteristics

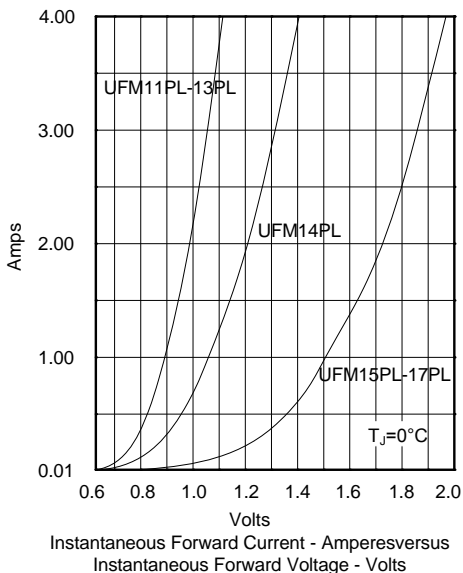

Figure 2
Typical Forward Characteristics

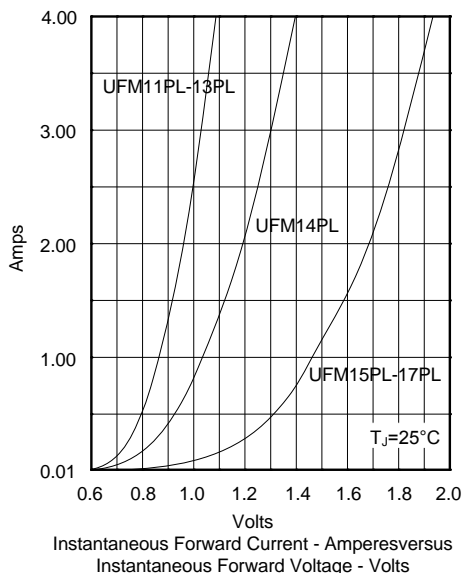

Figure 3
Typical Forward Characteristics

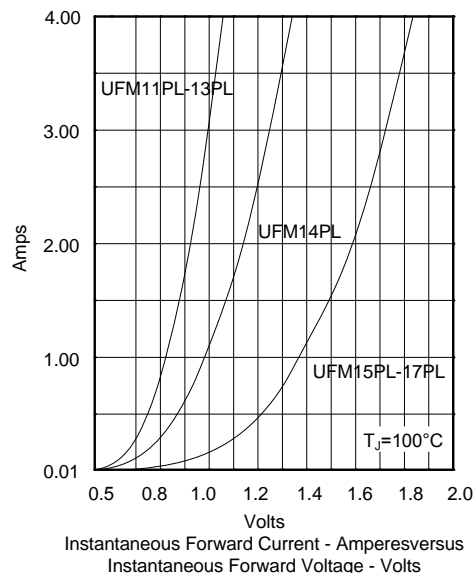
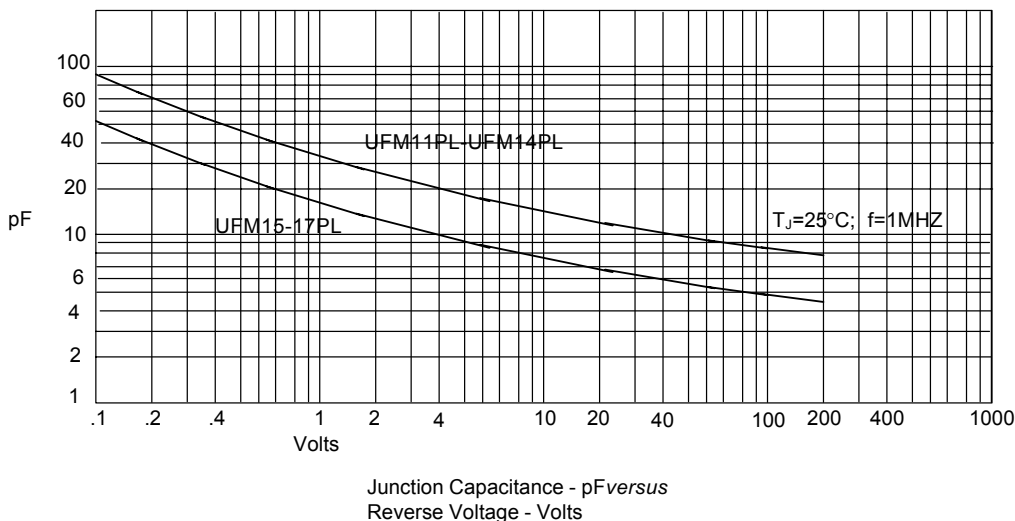

Figure 4
Junction Capacitance



UFM11PL THRU UFM17PL

TYPICAL CHARACTERISTICS

Figure 5
Peak Forward Surge Current

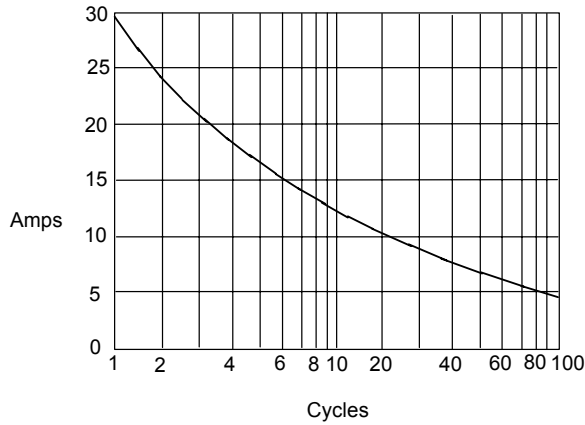

Peak Forward Surge Current - Amperes *versus*
Number Of Cycles At 60Hz - Cycles

Figure 6
Forward Derating Curve

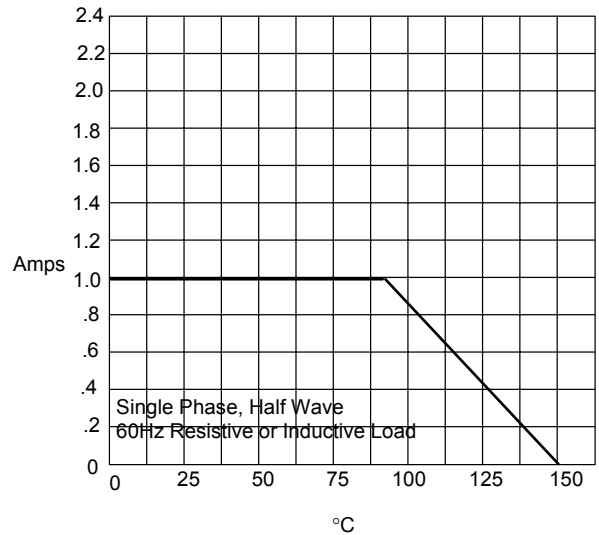

Average Forward Rectified Current - Amperes *versus*
Lead Temperature - °C

Figure 7
Reverse Recovery Time Characteristic And Test Circuit Diagram

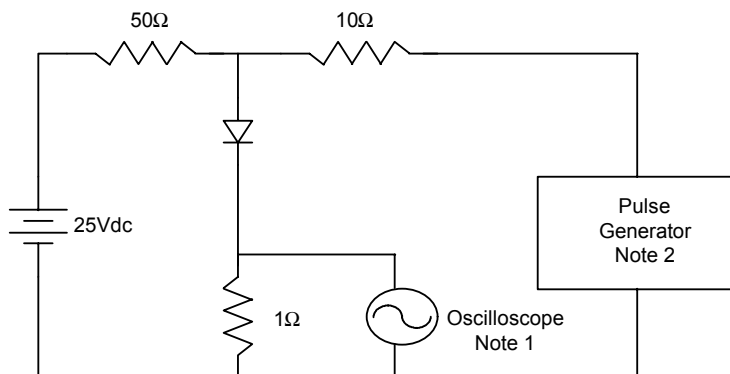

- Notes:
1. Rise Time = 7ns max.
Input impedance = 1 megohm, 22pF
 2. Rise Time = 10ns max.
Source impedance = 50 ohms
 3. Resistors are non-inductive

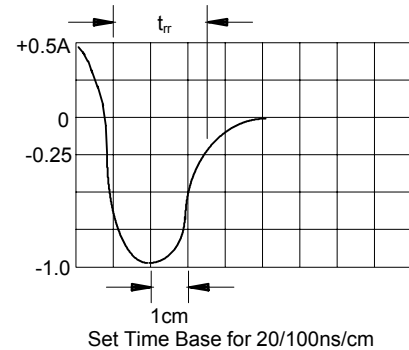



Micro Commercial Components

Ordering Information :

Device	Packing
Part Number-TP	Tape&Reel: 2.5Kpcs/Reel

Note : Adding "-HF" suffix for halogen free, eg. Part Number-TP-HF

IMPORTANT NOTICE

Micro Commercial Components Corp. reserves the right to make changes without further notice to any product herein to make corrections, modifications , enhancements , improvements , or other changes . Micro Commercial Components Corp . does not assume any liability arising out of the application or use of any product described herein; neither does it convey any license under its patent rights ,nor the rights of others . The user of products in such applications shall assume all risks of such use and will agree to hold Micro Commercial Components Corp . and all the companies whose products are represented on our website, harmless against all damages.

LIFE SUPPORT

MCC's products are not authorized for use as critical components in life support devices or systems without the express written approval of Micro Commercial Components Corporation.

CUSTOMER AWARENESS

Counterfeiting of semiconductor parts is a growing problem in the industry. Micro Commercial Components (MCC) is taking strong measures to protect ourselves and our customers from the proliferation of counterfeit parts. MCC strongly encourages customers to purchase MCC parts either directly from MCC or from Authorized MCC Distributors who are listed by country on our web page cited below. Products customers buy either from MCC directly or from Authorized MCC Distributors are genuine parts, have full traceability, meet MCC's quality standards for handling and storage. MCC will not provide any warranty coverage or other assistance for parts bought from Unauthorized Sources. MCC is committed to combat this global problem and encourage our customers to do their part in stopping this practice by buying direct or from authorized distributors.

Looking for pricing, stock, or lifecycle information?

Click below to explore more details on WIN SOURCE:

- ⊖ [View UFM15PL-TP on WIN SOURCE](#)
- ⊖ [Micro Commercial Co](#) Information

Optimize Your Supply Chain with WIN SOURCE Solutions

- ✓ Global Sourcing Solution
- ✓ Obsolete Management
- ✓ Cost Control Management
- ✓ Shortage Management
- ✓ Alternative Solution
- ✓ Excess Inventory Management