



THE DATASHEET OF BAV102,115



Important notice

Dear Customer,

On 7 February 2017 the former NXP Standard Product business became a new company with the tradename **Nexperia**. Nexperia is an industry leading supplier of Discrete, Logic and PowerMOS semiconductors with its focus on the automotive, industrial, computing, consumer and wearable application markets

In data sheets and application notes which still contain NXP or Philips Semiconductors references, use the references to Nexperia, as shown below.

Instead of <http://www.nxp.com>, <http://www.philips.com/> or <http://www.semiconductors.philips.com/>, use <http://www.nexperia.com>

Instead of sales.addresses@www.nxp.com or sales.addresses@www.semiconductors.philips.com, use salesaddresses@nexperia.com (email)

Replace the copyright notice at the bottom of each page or elsewhere in the document, depending on the version, as shown below:

- © NXP N.V. (year). All rights reserved or © Koninklijke Philips Electronics N.V. (year). All rights reserved

Should be replaced with:

- © **Nexperia B.V. (year). All rights reserved.**

If you have any questions related to the data sheet, please contact our nearest sales office via e-mail or telephone (details via salesaddresses@nexperia.com). Thank you for your cooperation and understanding,

Kind regards,

Team Nexperia

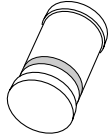

BAV102; BAV103

Single general-purpose switching diodes

Rev. 4 — 6 August 2010

Product data sheet

1. Product profile

1.1 General description

Single general-purpose switching diodes, fabricated in planar technology, and encapsulated in small hermetically sealed glass SOD80C Surface-Mounted Device (SMD) packages.

Table 1. Product overview

Type number	Package		Configuration
	NXP	JEITA	
BAV102	SOD80C	-	single
BAV103			

1.2 Features and benefits

- High switching speed: $t_{rr} \leq 50$ ns
- Low leakage current
- Low capacitance: $C_d \leq 5$ pF
- Small hermetically sealed glass SMD package

1.3 Applications

- High-speed switching
- General-purpose switching
- Voltage clamping
- Reverse polarity protection

1.4 Quick reference data

Table 2. Quick reference data

Symbol	Parameter	Conditions	Min	Typ	Max	Unit
I_F	forward current	[1][2]	-	-	250	mA
V_R	reverse voltage					
	BAV102		-	-	150	V
	BAV103		-	-	200	V
t_{rr}	reverse recovery time	[3]	-	-	50	ns

[1] Pulse test: $t_p \leq 300$ μ s; $\delta \leq 0.02$.



[2] Device mounted on an FR4 Printed-Circuit Board (PCB), single-sided copper, tin-plated and standard footprint.

[3] When switched from $I_F = 30$ mA to $I_R = 30$ mA; $R_L = 100$ Ω ; measured at $I_R = 3$ mA.

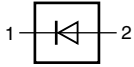

2. Pinning information

Table 3. Pinning

Pin	Description	Simplified outline	Graphic symbol
1	cathode	[1]	 006aab040
2	anode		

[1] The marking band indicates the cathode.

3. Ordering information

Table 4. Ordering information

Type number	Package		
	Name	Description	Version
BAV102	-	hermetically sealed glass surface-mounted package;	SOD80C
BAV103	-	2 connectors	

4. Marking

Table 5. Marking codes

Type number	Marking code
BAV102	marking band
BAV103	marking band

5. Limiting values

Table 6. Limiting values

In accordance with the Absolute Maximum Rating System (IEC 60134).

Symbol	Parameter	Conditions	Min	Max	Unit
V_{RRM}	repetitive peak reverse voltage				
		BAV102	-	200	V
		BAV103	-	250	V
V_R	reverse voltage				
		BAV102	-	150	V
		BAV103	-	200	V
I_F	forward current	[1][2]	-	250	mA
I_{FRM}	repetitive peak forward current		-	625	mA
I_{FSM}	non-repetitive peak forward current	square wave	[3]		
		$t_p = 1 \mu\text{s}$	-	9	A
		$t_p = 100 \mu\text{s}$	-	3	A
		$t_p = 1 \text{ s}$	-	1	A

Table 6. Limiting values ...continued*In accordance with the Absolute Maximum Rating System (IEC 60134).*

Symbol	Parameter	Conditions	Min	Max	Unit
P_{tot}	total power dissipation	$T_{\text{amb}} \leq 25\text{ °C}$	[2] -	400	mW
T_j	junction temperature		-	175	°C
T_{amb}	ambient temperature		-65	+175	°C
T_{stg}	storage temperature		-65	+175	°C

[1] Pulse test: $t_p \leq 300\ \mu\text{s}$; $\delta \leq 0.02$.

[2] Device mounted on an FR4 PCB, single-sided copper, tin-plated and standard footprint.

[3] $T_j = 25\text{ °C}$ prior to surge.

6. Thermal characteristics

Table 7. Thermal characteristics

Symbol	Parameter	Conditions	Min	Typ	Max	Unit
$R_{\text{th}(j-a)}$	thermal resistance from junction to ambient	in free air	[1] -	-	375	K/W
$R_{\text{th}(j-t)}$	thermal resistance from junction to tie-point		-	-	300	K/W

[1] Device mounted on an FR4 PCB, single-sided copper, tin-plated and standard footprint.

7. Characteristics

Table 8. Characteristics *$T_{\text{amb}} = 25\text{ °C}$ unless otherwise specified.*

Symbol	Parameter	Conditions	Min	Typ	Max	Unit	
V_F	forward voltage		[1]				
		$I_F = 100\text{ mA}$	-	-	1.0	V	
		$I_F = 200\text{ mA}$	-	-	1.25	V	
I_R	reverse current						
		BAV102	$V_R = 150\text{ V}$	-	-	100	nA
			$V_R = 150\text{ V}; T_j = 150\text{ °C}$	-	-	100	μA
		BAV103	$V_R = 200\text{ V}$	-	-	100	nA
			$V_R = 200\text{ V}; T_j = 150\text{ °C}$	-	-	100	μA
C_d	diode capacitance	$f = 1\text{ MHz}; V_R = 0\text{ V}$	-	-	5	pF	
t_{rr}	reverse recovery time		[2] -	-	50	ns	

[1] Pulse test: $t_p \leq 300\ \mu\text{s}$; $\delta \leq 0.02$.[2] When switched from $I_F = 30\text{ mA}$ to $I_R = 30\text{ mA}$; $R_L = 100\ \Omega$; measured at $I_R = 3\text{ mA}$.

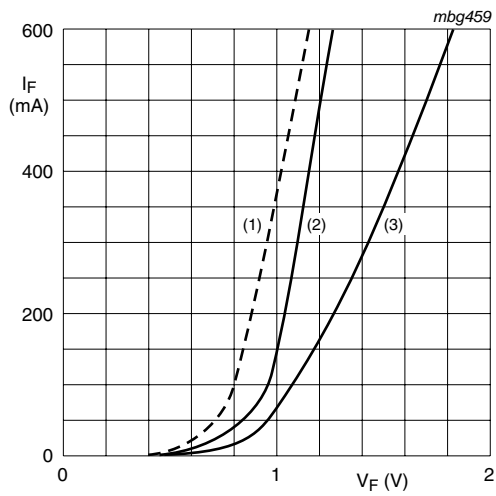

- (1) $T_{amb} = 150\text{ °C}$; typical values
- (2) $T_{amb} = 25\text{ °C}$; typical values
- (3) $T_{amb} = 25\text{ °C}$; maximum values

Fig 1. Forward current as a function of forward voltage

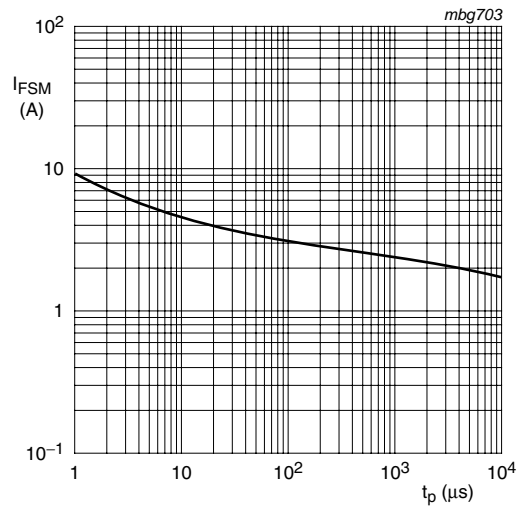

Based on square wave currents.
 $T_j = 25\text{ °C}$; prior to surge

Fig 2. Non-repetitive peak forward current as a function of pulse duration; maximum values

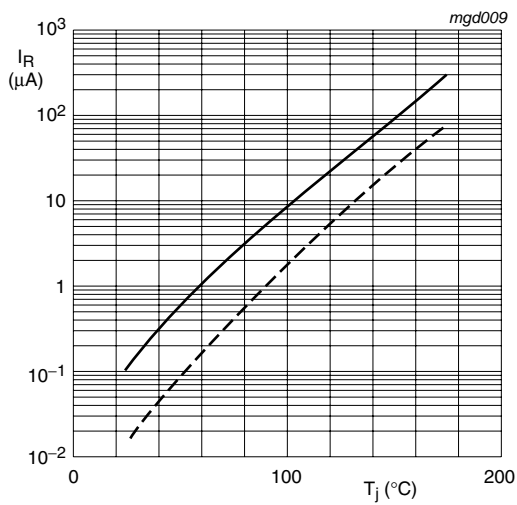

$V_R = V_{Rmax}$
 Solid line: maximum values
 Dotted line: typical values

Fig 3. Reverse current as a function of junction temperature

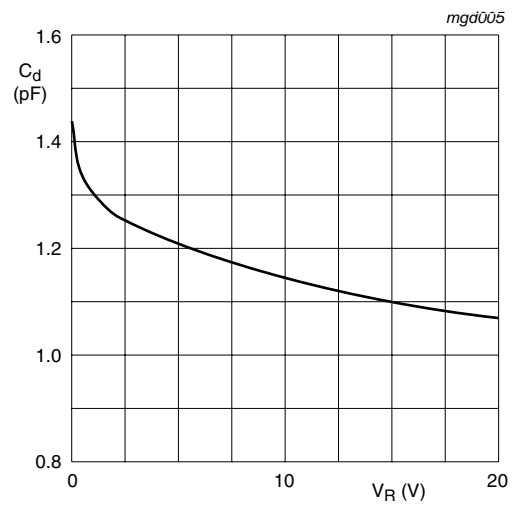

$f = 1\text{ MHz}$; $T_{amb} = 25\text{ °C}$

Fig 4. Diode capacitance as a function of reverse voltage; typical values

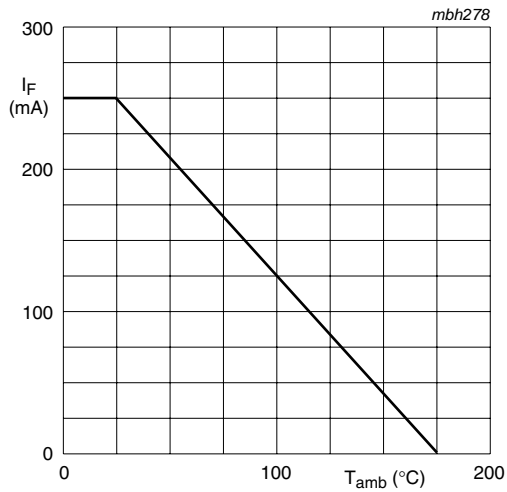

FR4 PCB, standard footprint

Fig 5. Forward current as a function of ambient temperature; derating curve

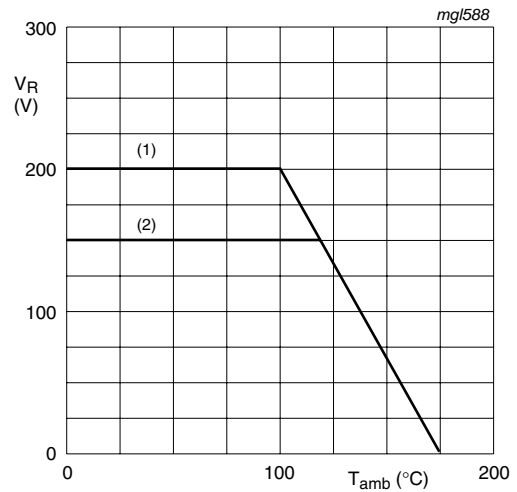

FR4 PCB, standard footprint

- (1) BAV103
- (2) BAV102

Fig 6. Reverse voltage as a function of ambient temperature; derating curve

8. Test information

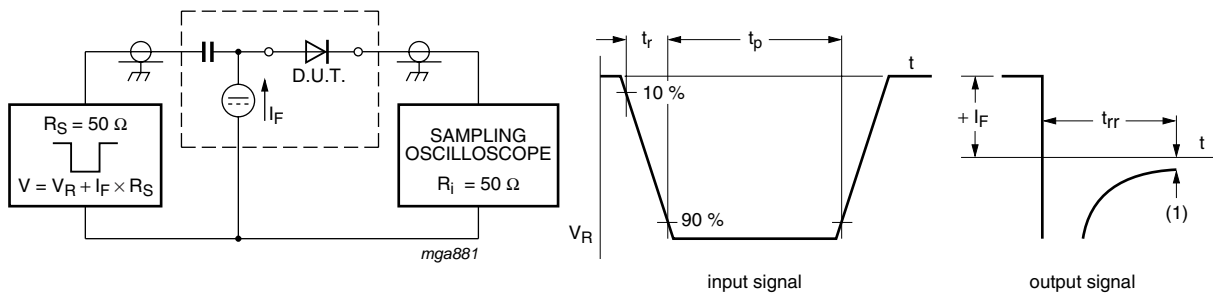

- (1) $I_R = 1 \text{ mA}$

Fig 7. Reverse recovery time test circuit and waveforms

9. Package outline

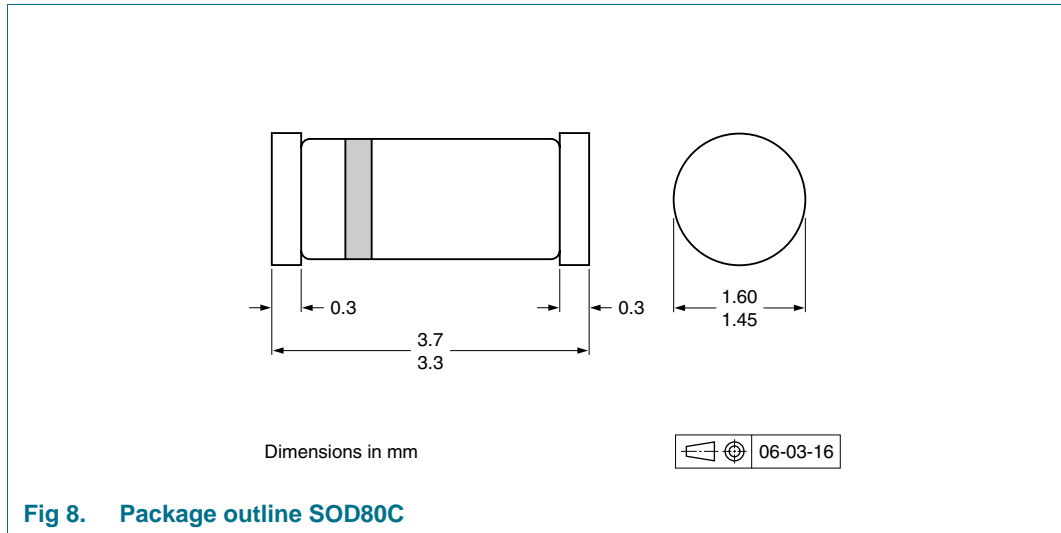

10. Packing information

Table 9. Packing methods

The indicated -xxx are the last three digits of the 12NC ordering code.^[1]

Type number	Package	Description	Packing quantity	
			2500	10000
BAV102	SOD80C	4 mm pitch, 8 mm tape and reel	-115	-135
BAV103				

[1] For further information and the availability of packing methods, see [Section 14](#).

11. Soldering

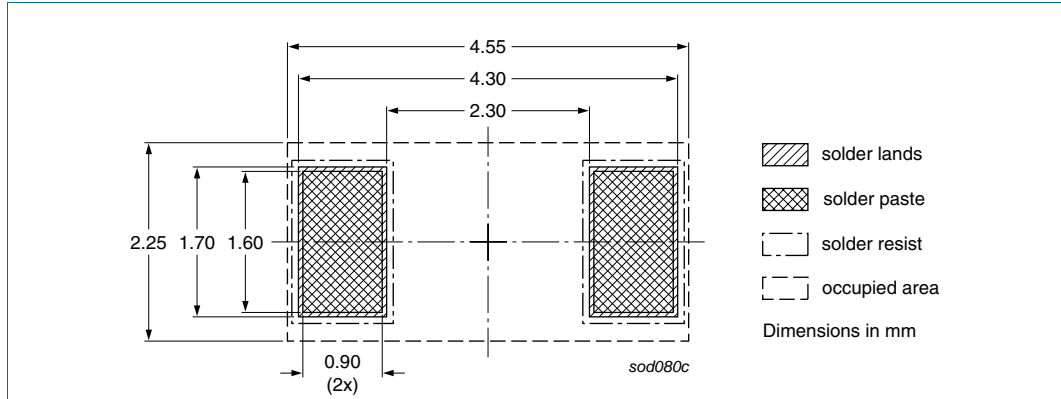

Fig 9. Reflow soldering footprint SOD80C

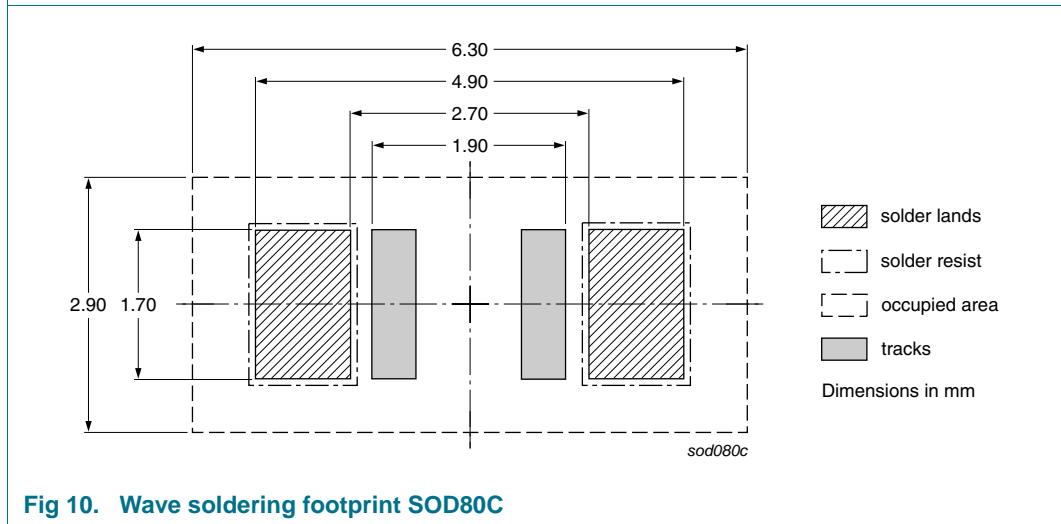

Fig 10. Wave soldering footprint SOD80C

12. Revision history

Table 10. Revision history

Document ID	Release date	Data sheet status	Change notice	Supersedes
BAV102_BAV103 v.4	20100806	Product data sheet	-	BAV102_BAV103_3
Modifications:	<ul style="list-style-type: none">• Section 4 "Marking": updated• Section 13 "Legal information": updated			
BAV102_BAV103_3	20070816	Product data sheet	-	BAV100_2
BAV100_2	19960917	Product specification	-	BAV100_1
BAV100_1	19960423	Product specification	-	-

13. Legal information

13.1 Data sheet status

Document status ^{[1][2]}	Product status ^[3]	Definition
Objective [short] data sheet	Development	This document contains data from the objective specification for product development.
Preliminary [short] data sheet	Qualification	This document contains data from the preliminary specification.
Product [short] data sheet	Production	This document contains the product specification.

[1] Please consult the most recently issued document before initiating or completing a design.

[2] The term 'short data sheet' is explained in section "Definitions".

[3] The product status of device(s) described in this document may have changed since this document was published and may differ in case of multiple devices. The latest product status information is available on the Internet at URL <http://www.nxp.com>.

13.2 Definitions

Draft — The document is a draft version only. The content is still under internal review and subject to formal approval, which may result in modifications or additions. NXP Semiconductors does not give any representations or warranties as to the accuracy or completeness of information included herein and shall have no liability for the consequences of use of such information.

Short data sheet — A short data sheet is an extract from a full data sheet with the same product type number(s) and title. A short data sheet is intended for quick reference only and should not be relied upon to contain detailed and full information. For detailed and full information see the relevant full data sheet, which is available on request via the local NXP Semiconductors sales office. In case of any inconsistency or conflict with the short data sheet, the full data sheet shall prevail.

Product specification — The information and data provided in a Product data sheet shall define the specification of the product as agreed between NXP Semiconductors and its customer, unless NXP Semiconductors and customer have explicitly agreed otherwise in writing. In no event however, shall an agreement be valid in which the NXP Semiconductors product is deemed to offer functions and qualities beyond those described in the Product data sheet.

13.3 Disclaimers

Limited warranty and liability — Information in this document is believed to be accurate and reliable. However, NXP Semiconductors does not give any representations or warranties, expressed or implied, as to the accuracy or completeness of such information and shall have no liability for the consequences of use of such information.

In no event shall NXP Semiconductors be liable for any indirect, incidental, punitive, special or consequential damages (including - without limitation - lost profits, lost savings, business interruption, costs related to the removal or replacement of any products or rework charges) whether or not such damages are based on tort (including negligence), warranty, breach of contract or any other legal theory.

Notwithstanding any damages that customer might incur for any reason whatsoever, NXP Semiconductors' aggregate and cumulative liability towards customer for the products described herein shall be limited in accordance with the *Terms and conditions of commercial sale* of NXP Semiconductors.

Right to make changes — NXP Semiconductors reserves the right to make changes to information published in this document, including without limitation specifications and product descriptions, at any time and without notice. This document supersedes and replaces all information supplied prior to the publication hereof.

Suitability for use — NXP Semiconductors products are not designed, authorized or warranted to be suitable for use in life support, life-critical or safety-critical systems or equipment, nor in applications where failure or

malfunction of an NXP Semiconductors product can reasonably be expected to result in personal injury, death or severe property or environmental damage. NXP Semiconductors accepts no liability for inclusion and/or use of NXP Semiconductors products in such equipment or applications and therefore such inclusion and/or use is at the customer's own risk.

Applications — Applications that are described herein for any of these products are for illustrative purposes only. NXP Semiconductors makes no representation or warranty that such applications will be suitable for the specified use without further testing or modification.

Customers are responsible for the design and operation of their applications and products using NXP Semiconductors products, and NXP Semiconductors accepts no liability for any assistance with applications or customer product design. It is customer's sole responsibility to determine whether the NXP Semiconductors product is suitable and fit for the customer's applications and products planned, as well as for the planned application and use of customer's third party customer(s). Customers should provide appropriate design and operating safeguards to minimize the risks associated with their applications and products.

NXP Semiconductors does not accept any liability related to any default, damage, costs or problem which is based on any weakness or default in the customer's applications or products, or the application or use by customer's third party customer(s). Customer is responsible for doing all necessary testing for the customer's applications and products using NXP Semiconductors products in order to avoid a default of the applications and the products or of the application or use by customer's third party customer(s). NXP does not accept any liability in this respect.

Limiting values — Stress above one or more limiting values (as defined in the Absolute Maximum Ratings System of IEC 60134) will cause permanent damage to the device. Limiting values are stress ratings only and (proper) operation of the device at these or any other conditions above those given in the Recommended operating conditions section (if present) or the Characteristics sections of this document is not warranted. Constant or repeated exposure to limiting values will permanently and irreversibly affect the quality and reliability of the device.

Terms and conditions of commercial sale — NXP Semiconductors products are sold subject to the general terms and conditions of commercial sale, as published at <http://www.nxp.com/profile/terms>, unless otherwise agreed in a valid written individual agreement. In case an individual agreement is concluded only the terms and conditions of the respective agreement shall apply. NXP Semiconductors hereby expressly objects to applying the customer's general terms and conditions with regard to the purchase of NXP Semiconductors products by customer.

No offer to sell or license — Nothing in this document may be interpreted or construed as an offer to sell products that is open for acceptance or the grant, conveyance or implication of any license under any copyrights, patents or other industrial or intellectual property rights.

Export control — This document as well as the item(s) described herein may be subject to export control regulations. Export might require a prior authorization from national authorities.

Quick reference data — The Quick reference data is an extract of the product data given in the Limiting values and Characteristics sections of this document, and as such is not complete, exhaustive or legally binding.

Non-automotive qualified products — Unless this data sheet expressly states that this specific NXP Semiconductors product is automotive qualified, the product is not suitable for automotive use. It is neither qualified nor tested in accordance with automotive testing or application requirements. NXP Semiconductors accepts no liability for inclusion and/or use of non-automotive qualified products in automotive equipment or applications.

In the event that customer uses the product for design-in and use in automotive applications to automotive specifications and standards, customer (a) shall use the product without NXP Semiconductors' warranty of the

product for such automotive applications, use and specifications, and (b) whenever customer uses the product for automotive applications beyond NXP Semiconductors' specifications such use shall be solely at customer's own risk, and (c) customer fully indemnifies NXP Semiconductors for any liability, damages or failed product claims resulting from customer design and use of the product for automotive applications beyond NXP Semiconductors' standard warranty and NXP Semiconductors' product specifications.

13.4 Trademarks

Notice: All referenced brands, product names, service names and trademarks are the property of their respective owners.

14. Contact information

For more information, please visit: <http://www.nxp.com>

For sales office addresses, please send an email to: salesaddresses@nxp.com

15. Contents

1 Product profile 1

1.1 General description 1

1.2 Features and benefits 1

1.3 Applications 1

1.4 Quick reference data 1

2 Pinning information 2

3 Ordering information 2

4 Marking 2

5 Limiting values 2

6 Thermal characteristics 3

7 Characteristics 3

8 Test information 5

9 Package outline 6

10 Packing information 6

11 Soldering 7

12 Revision history 8

13 Legal information 9

13.1 Data sheet status 9

13.2 Definitions 9

13.3 Disclaimers 9

13.4 Trademarks 10

14 Contact information 10

15 Contents 11

Please be aware that important notices concerning this document and the product(s) described herein, have been included in section 'Legal information'.



© NXP B.V. 2010. All rights reserved.

For more information, please visit: <http://www.nxp.com>
 For sales office addresses, please send an email to: salesaddresses@nxp.com

Date of release: 6 August 2010
 Document identifier: BAV102_BAV103

Looking for pricing, stock, or lifecycle information?

Click below to explore more details on WIN SOURCE:

-  [View BAV102,115 on WIN SOURCE](#)
-  [Nexperia USA Inc. Information](#)

Optimize Your Supply Chain with WIN SOURCE Solutions

-  Global Sourcing Solution
-  Obsolete Management
-  Cost Control Management
-  Shortage Management
-  Alternative Solution
-  Excess Inventory Management