



**THE DATASHEET OF
LT1222IS8#PBF**



FEATURES

- **Gain-Bandwidth: 500MHz**
- **Gain of 10 Stable Uncompensated**
- **Slew Rate: 200V/ μs**
- Input Noise Voltage: $3\text{nV}/\sqrt{\text{Hz}}$
- C-Load™ Op Amp Drives Capacitive Loads
- External Compensation Pin
- Maximum Input Offset Voltage: $300\mu\text{V}$
- Maximum Input Bias Current: 300nA
- Maximum Input Offset Current: 300nA
- Minimum Output Swing Into 500Ω : $\pm 12\text{V}$
- Minimum DC Gain: $100\text{V}/\text{mV}$, $R_L = 500\Omega$
- Settling Time to 0.1%: 75ns , 10V Step
- Settling Time to 0.01%: 120ns , 10V Step
- Differential Gain: 0.4%, $A_V = 2$, $R_L = 150\Omega$
- Differential Phase: 0.1° , $A_V = 2$, $R_L = 150\Omega$

APPLICATIONS

- Wideband Amplifiers
- Buffers
- Active Filters
- Video and RF Amplification
- Cable Drivers
- 8-, 10-, 12-Bit Data Acquisition Systems

DESCRIPTION

The LT[®]1222 is a low noise, very high speed operational amplifier with superior DC performance. The LT1222 is stable in a noise gain of 10 or greater without compensation, or the part can be externally compensated for lower closed-loop gain at the expense of lower bandwidth and slew rate. It features reduced input offset voltage, lower input bias currents, lower noise and higher DC gain than devices with comparable bandwidth and slew rate. The circuit is a single gain stage that includes proprietary DC gain enhancement circuitry to obtain precision with high speed. The high gain and fast settling time make the circuit an ideal choice for data acquisition systems. The circuit is also capable of driving capacitive loads which makes it useful in buffer or cable driver applications. The compensation node can also be used to clamp the output swing.

The LT1222 is a member of a family of fast, high performance amplifiers that employ Linear Technology Corporation's advanced complementary bipolar processing. For unity-gain stable applications the LT1220 can be used, and for gains of 4 or greater the LT1221 can be used.

LT, LTC and LTM are registered trademarks of Linear Technology Corporation.
C-Load is a trademark of Linear Technology Corporation.

TYPICAL APPLICATION

$A_V = 10$ with Output Clamping

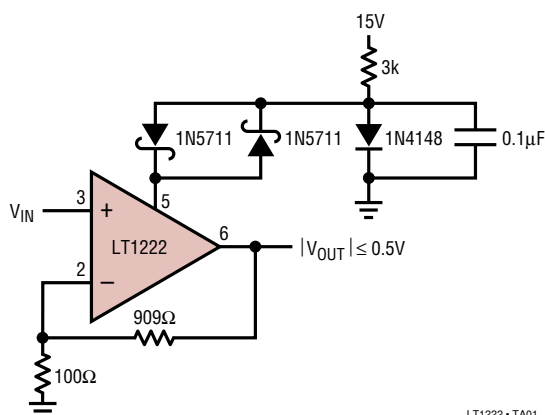

LT1222 • TA01

$A_V = -1$, $C_C = 30\text{pF}$ Pulse Response

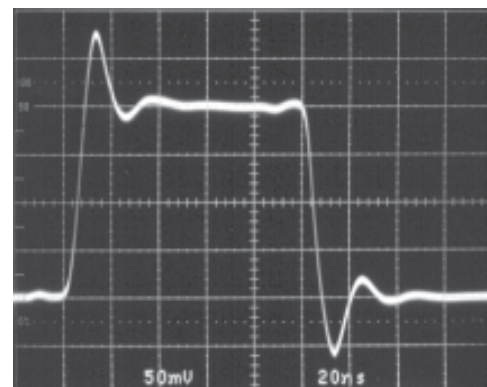

$R_F = R_G = 1\text{k}$
 $V_{IN} = 100\text{mV}$
 $V_S = \pm 15\text{V}$
 $f = 5\text{MHz}$

LT1222 • TA02

1222fc

ABSOLUTE MAXIMUM RATINGS (Note 1)

Total Supply Voltage (V^+ to V^-)	36V	Operating Temperature Range	
Differential Input Voltage	$\pm 6V$	LT1222C	-40°C TO 85°C
Input Voltage	$\pm V_S$	LT1222I	-40°C TO 85°C
Output Short-Circuit Duration (Note 2)	Indefinite	LT1222M (OBSELETE)	-55°C TO 125°C
Specified Temperature Range		Maximum Junction Temperature (See Below)	
LT1222C (Note 3)	0°C TO 70°C	Plastic Package	150°C
LT1222I	-40°C TO 85°C	Ceramic Package (OBSELETE)	175°C
LT1222M (OBSELETE)	-55°C TO 125°C	Storage Temperature Range	-65°C TO 150°C
		Lead Temperature (Soldering, 10 sec)	300°C

PACKAGE/ORDER INFORMATION

<p>TOP VIEW</p> <p>H PACKAGE 8-LEAD TO-5 METAL CAN $T_{JMAX} = 175^\circ\text{C}$, $\theta_{JA} = 150^\circ\text{C/W}$</p>	ORDER PART NUMBER	<p>TOP VIEW</p> <p>N8 PACKAGE 8-LEAD PLASTIC DIP $T_{JMAX} = 150^\circ\text{C}$, $\theta_{JA} = 130^\circ\text{C/W}$ (N) $T_{JMAX} = 150^\circ\text{C}$, $\theta_{JA} = 190^\circ\text{C/W}$ (S)</p> <p>S8 PACKAGE 8-LEAD PLASTIC SOIC $T_{JMAX} = 150^\circ\text{C}$, $\theta_{JA} = 190^\circ\text{C/W}$ (S)</p>	ORDER PART NUMBER
	SPECIAL ORDER CONSULT FACTORY		<p>LT1222CN8</p> <p>LT1222CS8</p> <p>LT1222IS8</p>
<p>OBSELETE PACKAGE</p> <p>Consider the N8 or S8 Packages for Alternate Source</p>		<p>J8 PACKAGE 8-LEAD CERAMIC DIP $T_{JMAX} = 175^\circ\text{C}$, $\theta_{JA} = 100^\circ\text{C/W}$ (J)</p>	S8 PART MARKING
			<p>1222</p> <p>1222I</p>
	ORDER PART NUMBER		LT1222MJ8
		<p>OBSELETE PACKAGE</p> <p>Consider the N8 or S8 Packages for Alternate Source</p>	

Consult LTC Marketing for parts specified with wider operating temperature ranges.

ELECTRICAL CHARACTERISTICS $T_A = 25^\circ\text{C}$, $V_S = \pm 15V$, $V_{CM} = 0V$, unless otherwise specified.

SYMBOL	PARAMETER	CONDITIONS	MIN	TYP	MAX	UNITS
V_{OS}	Input Offset Voltage	(Note 4)		100	300	μV
I_{OS}	Input Offset Current			100	300	nA
I_B	Input Bias Current			100	300	nA
e_n	Input Noise Voltage	$f = 10\text{kHz}$		3		$\text{nV}/\sqrt{\text{Hz}}$
i_n	Input Noise Current	$f = 10\text{kHz}$		2		$\text{pA}/\sqrt{\text{Hz}}$
R_{IN}	Input Resistance	$V_{CM} = \pm 12V$ Differential	20	45 12		$\text{M}\Omega$ $\text{k}\Omega$
C_{IN}	Input Capacitance			2		pF
	Input Voltage Range (Positive)		12	14		V
	Input Voltage Range (Negative)			-13	-12	V
CMRR	Common Mode Rejection Ratio	$V_{CM} = \pm 12V$	100	120		dB
PSRR	Power Supply Rejection Ratio	$V_S = \pm 5V$ to $\pm 15V$	98	110		dB
A_{VOL}	Large-Signal Voltage Gain	$V_{OUT} = \pm 10V$, $R_L = 500\Omega$	100	200		V/mV
V_{OUT}	Output Swing	$R_L = 500\Omega$	12	13		$\pm V$
I_{OUT}	Output Current	$V_{OUT} = \pm 12V$	24	26		mA
SR	Slew Rate	(Note 5)	150	200		V/ μs
	Full Power Bandwidth	10V Peak (Note 6)		3.2		MHz
GBW	Gain-Bandwidth	$f = 1\text{MHz}$		500		MHz

1222fc

ELECTRICAL CHARACTERISTICS $V_S = \pm 15V$, $T_A = 25^\circ C$, $V_{CM} = 0V$, unless otherwise specified.

SYMBOL	PARAMETER	CONDITIONS	MIN	TYP	MAX	UNITS
t_r, t_f	Rise Time, Fall Time	$A_V = 10$, 10% to 90%, 0.1V		2.4		ns
	Overshoot	$A_V = 10$, 0.1V		43		%
	Propagation Delay	$A_V = 10$, 50% V_{IN} to 50% V_{OUT} , 0.1V		5.2		ns
t_s	Settling Time	10V Step, 0.1% 10V Step, 0.01%		75 120		ns ns
	Differential Gain	$A_V = 2$, $C_C = 50pF$, $f = 3.58MHz$, $R_L = 150\Omega$ (Note 7) $A_V = 10$, $C_C = 0pF$, $f = 3.58MHz$, $R_L = 1k$ (Note 7)		0.40 0.15		% %
	Differential Phase	$A_V = 2$, $C_C = 50pF$, $f = 3.58MHz$, $R_L = 150\Omega$ (Note 7) $A_V = 10$, $C_C = 0pF$, $f = 3.58MHz$, $R_L = 1k$ (Note 7)		0.10 0.01		DEG DEG
R_O	Output Resistance	$A_V = 10$, $f = 1MHz$		0.1		Ω
I_S	Supply Current			8	10.5	mA

The ● denotes the specifications which apply over the temperature range $0^\circ C \leq T_A \leq 70^\circ C$, otherwise specifications are at $T_A = 25^\circ C$. $V_S = \pm 15V$, $V_{CM} = 0V$, unless otherwise specified.

SYMBOL	PARAMETER	CONDITIONS	MIN	TYP	MAX	UNITS
V_{OS}	Input Offset Voltage	(Note 4)	●	100	600	μV
	Input V_{OS} Drift		●	5		$\mu V/^\circ C$
I_{OS}	Input Offset Current		●	100	400	nA
I_B	Input Bias Current		●	100	400	nA
CMRR	Common Mode Rejection Ratio	$V_{CM} = \pm 12V$	●	100	120	dB
PSRR	Power Supply Rejection Ratio	$V_S = \pm 5V$ to $\pm 15V$	●	98	110	dB
A_{VOL}	Large-Signal Voltage Gain	$V_{OUT} = \pm 10V$, $R_L = 500\Omega$	●	100	200	V/mV
V_{OUT}	Output Swing	$R_L = 500\Omega$	●	12	13	$\pm V$
I_{OUT}	Output Current	$V_{OUT} = \pm 12V$	●	24	26	mA
SR	Slew Rate	(Note 5)	●	150	200	V/ μs
I_S	Supply Current		●	8	11	mA

The ● denotes the specifications which apply over the temperature range $-55^\circ C \leq T_A \leq 125^\circ C$ for LT1222M, $-40^\circ C \leq T_A \leq 85^\circ C$ for LT1222I, otherwise specifications are at $T_A = 25^\circ C$. $V_S = \pm 15V$, $V_{CM} = 0V$, unless otherwise specified.

SYMBOL	PARAMETER	CONDITIONS	MIN	TYP	MAX	UNITS
V_{OS}	Input Offset Voltage	(Note 4)	●	100	600	μV
	Input V_{OS} Drift		●	5		$\mu V/^\circ C$
I_{OS}	Input Offset Current		●	100	800	nA
I_B	Input Bias Current		●	100	1000	nA
CMRR	Common Mode Rejection Ratio	$V_{CM} = \pm 12V$	●	98	120	dB
PSRR	Power Supply Rejection Ratio	$V_S = \pm 5V$ to $\pm 15V$	●	98	110	dB
A_{VOL}	Large-Signal Voltage Gain	$V_{OUT} = \pm 10V$, $R_L = 500\Omega$	●	50	200	V/mV
V_{OUT}	Output Swing	$R_L = 500\Omega$ $R_L = 1k$	● ●	10 12	13 13	$\pm V$ $\pm V$
I_{OUT}	Output Current	$V_{OUT} = \pm 10V$ $V_{OUT} = \pm 12V$	● ●	20 12	26 13	mA mA
SR	Slew Rate	(Note 5)	●	110	200	V/ μs
I_S	Supply Current		●	8	11	mA

Note 1: Stresses beyond those listed under Absolute Maximum Ratings may cause permanent damage to the device. Exposure to any Absolute Maximum Rating condition for extended periods may affect device reliability and lifetime.

Note 2: A heat sink may be required when the output is shorted indefinitely.

Note 3: The LT1222C is guaranteed to meet specified performance from $0^\circ C$ to $70^\circ C$ and is designed, characterized and expected to meet these extended temperature limits, but is not tested at $-40^\circ C$ and $85^\circ C$. The LT1222I is

guaranteed to meet the extended temperature limits.

Note 4: Input offset voltage is pulse tested and is exclusive of warm-up drift.

Note 5: Slew rate is measured between $\pm 10V$ on an output swing of $\pm 12V$.

Note 6: $FPBW = SR/2\pi V_p$.

Note 7: Differential Gain and Phase are tested with five amps in series. Attenuators of $1/Gain$ are used as loads.

TYPICAL PERFORMANCE CHARACTERISTICS

Input Common Mode Range vs Supply Voltage

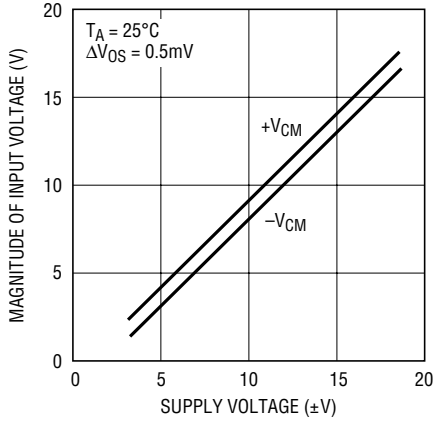

LT1222 • TPC01

Supply Current vs Supply Voltage and Temperature

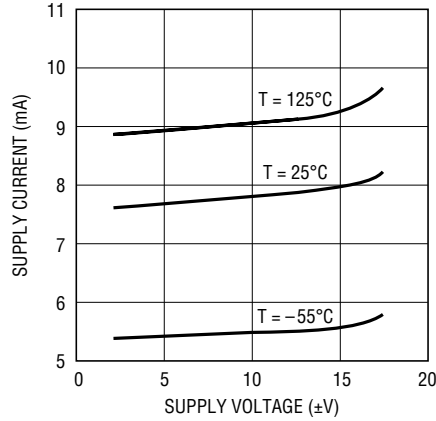

LT1222 • TPC02

Output Voltage Swing vs Supply Voltage

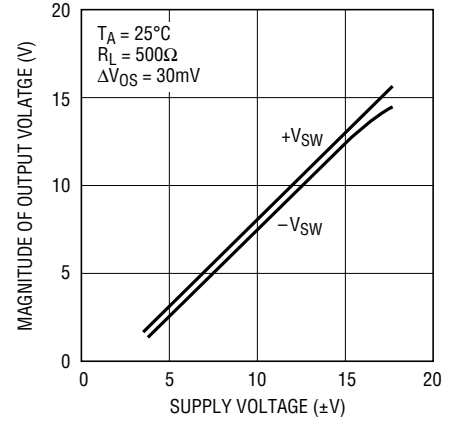

LT1222 • TPC03

Output Voltage Swing vs Resistive Load

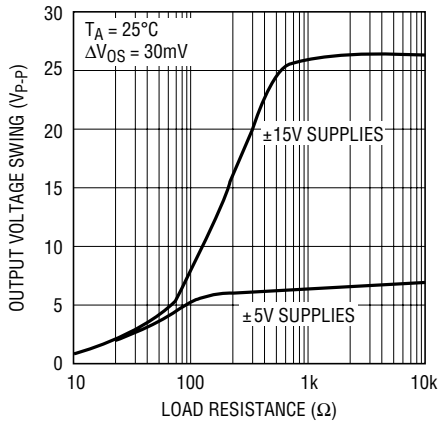

LT1222 • TPC04

Input Bias Current vs Input Common Mode Voltage

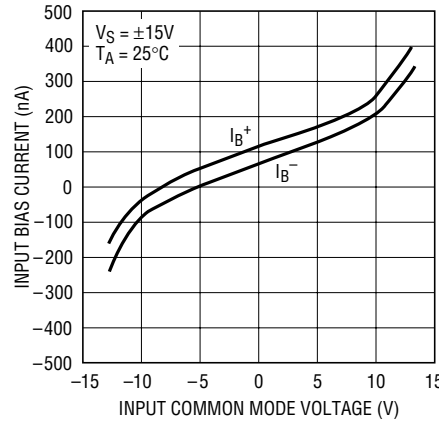

LT1222 • TPC05

Open-Loop Gain vs Resistive Load

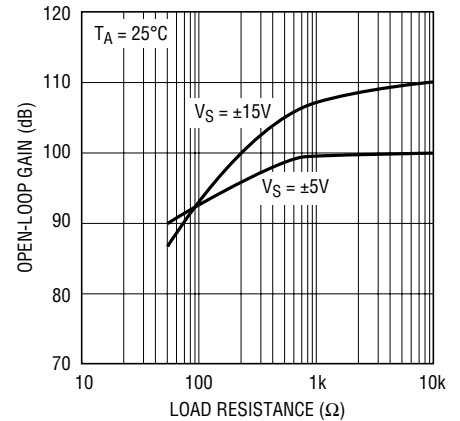

LT1222 • TPC06

Output Short-Circuit Current vs Temperature

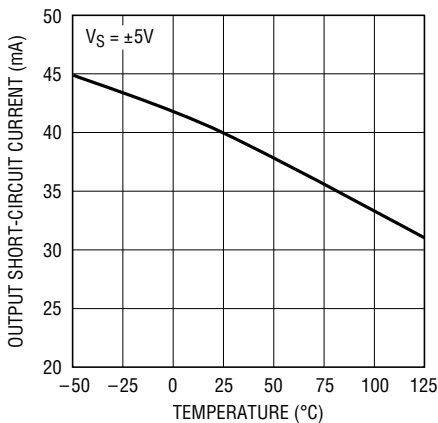

LT1222 • TPC07

Input Noise Spectral Density

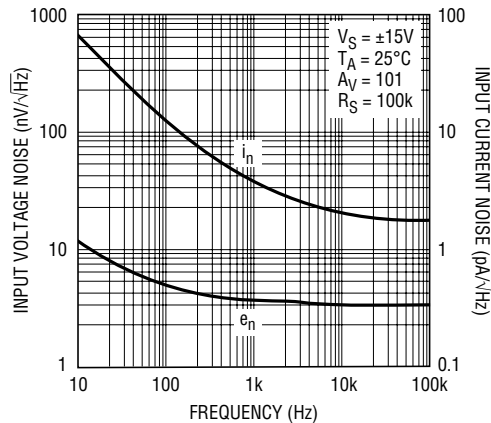

LT1222 • TPC08

Power Supply Rejection Ratio vs Frequency

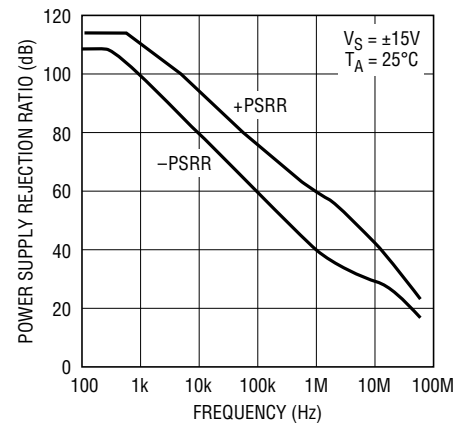

LT1222 • TPC09

TYPICAL PERFORMANCE CHARACTERISTICS

Common Mode Rejection Ratio vs Frequency

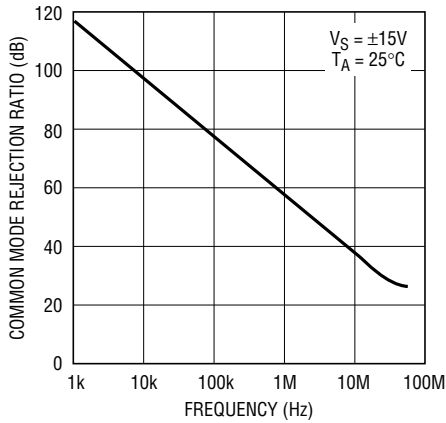

LT1222 • TPC10

Output Swing and Error vs Settling Time (Noninverting)

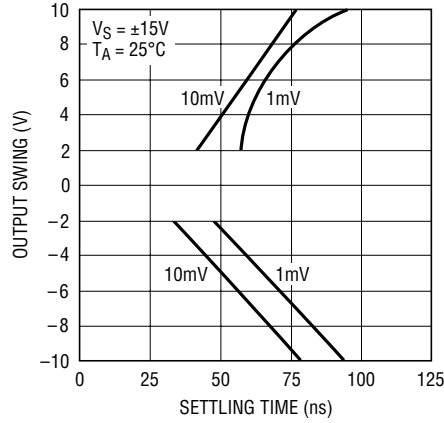

LT1222 • TPC11

Output Swing and Error vs Settling Time (Inverting)

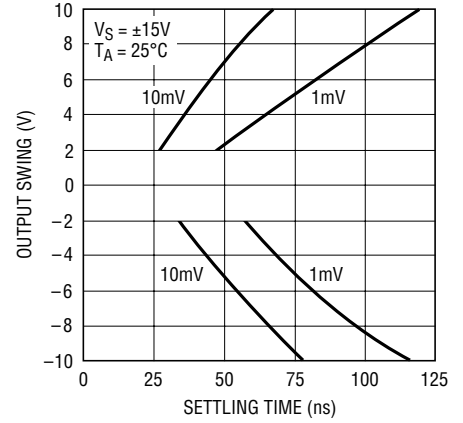

LT1222 • TPC12

Voltage Gain and Phase vs Frequency

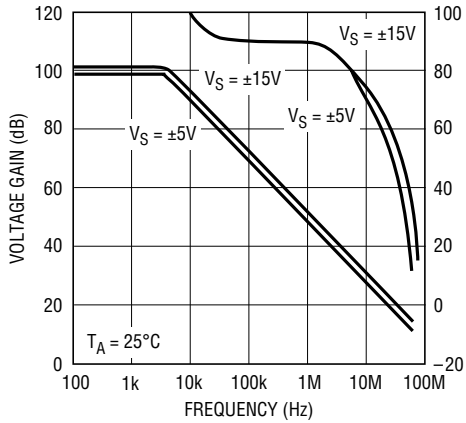

LT1222 • TPC13

Frequency Response vs Capacitive Load

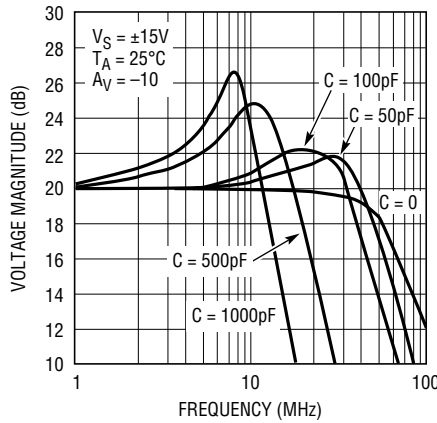

LT1222 • TPC14

Closed-Loop Output Impedance vs Frequency

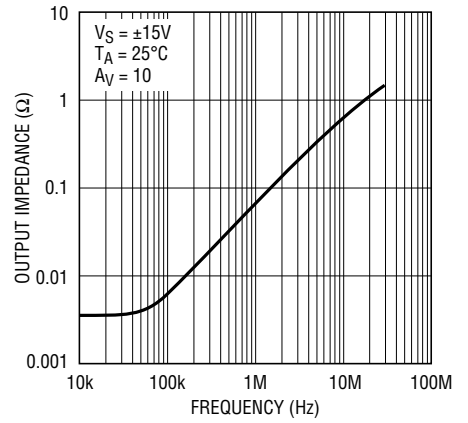

LT1222 • TPC15

Gain-Bandwidth vs Temperature

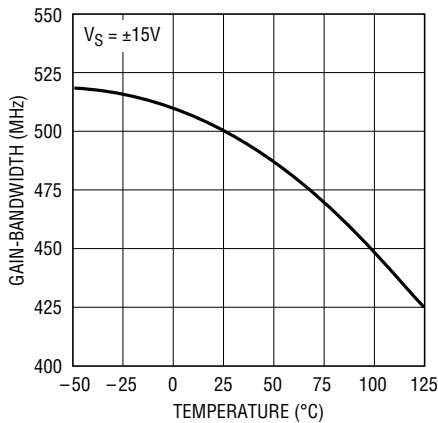

LT1222 • TPC16

Slew Rate vs Temperature

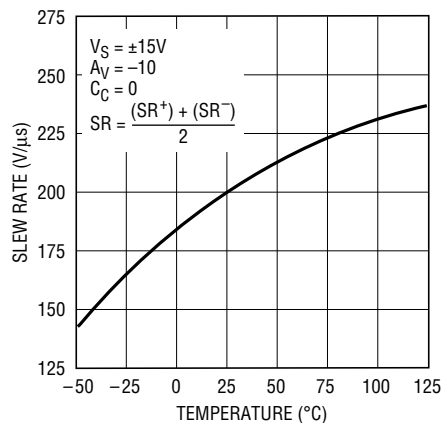

LT1222 • TPC17

Total Harmonic Distortion vs Frequency

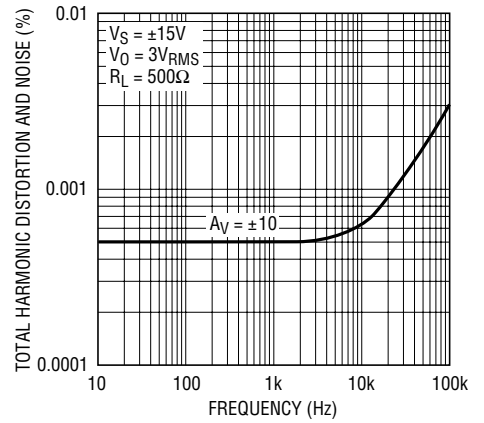

LT1222 • TPC18

TYPICAL PERFORMANCE CHARACTERISTICS

Small Signal, $A_V = 10$

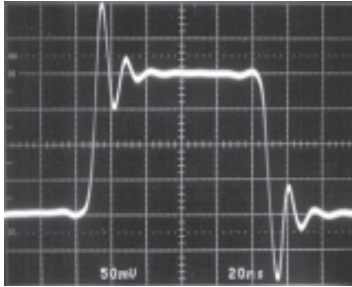

$R_F = 909\Omega$ $V_S = \pm 15V$ $f = 5MHz$ LT1222 • TPC19
 $R_G = 100\Omega$ $V_{IN} = 20mV$

Large Signal, $A_V = 10$

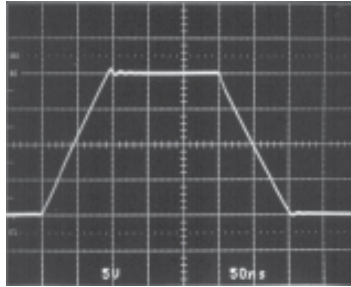

$R_F = 909\Omega$ $V_S = \pm 15V$ $f = 2MHz$ LT1222 • TPC20
 $R_G = 100\Omega$ $V_{IN} = 2V$

Large Signal, $A_V = 10$,
 $C_L = 10,000pF$

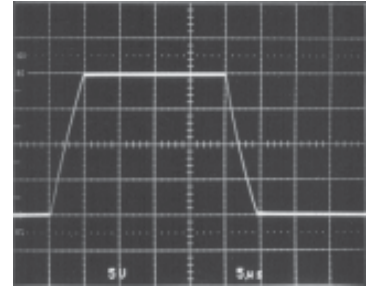

$R_F = 909\Omega$ $V_S = \pm 15V$ $f = 20kHz$ LT1222 • TPC21
 $R_G = 100\Omega$ $V_{IN} = 2V$

Small Signal, $A_V = -10$

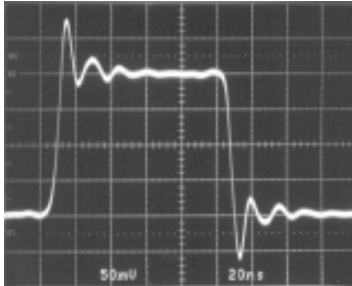

$R_F = 1k$ $V_S = \pm 15V$ $f = 5MHz$ LT1222 • TPC22
 $R_G = 100\Omega (75)$ $V_{IN} = 20mV$

Large Signal, $A_V = -10$

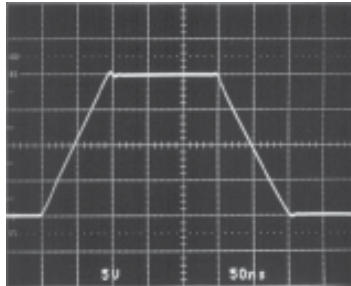

$R_F = 1k$ $V_S = \pm 15V$ $f = 2MHz$ LT1222 • TPC23
 $R_G = 100\Omega (75)$ $V_{IN} = 2V$

Small Signal, $A_V = -10$,
 $C_L = 1,000pF$

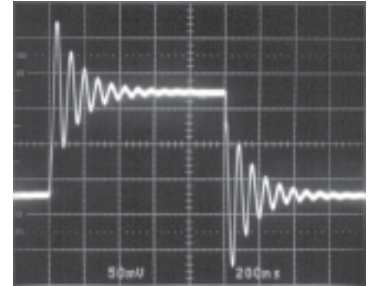

$R_F = 1k$ $V_S = \pm 15V$ $f = 500kHz$ LT1222 • TPC24
 $R_G = 100\Omega (75)$ $V_{IN} = 15mV$

APPLICATIONS INFORMATION

The LT1222 is stable in noise gains of 10 or greater and may be inserted directly into HA2520/2/5, HA2541/2/4, AD817, AD847, EL2020, EL2044 and LM6361 applications, provided that the nulling circuitry is removed and the amplifier configuration has a high enough noise gain. The suggested nulling circuit for the LT1222 is shown in the following figure.

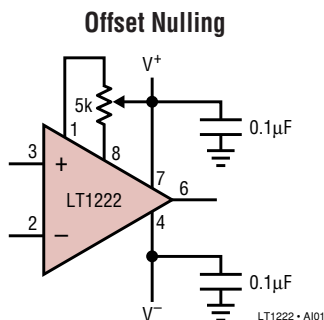

Layout and Passive Components

The LT1222 amplifier is easy to apply and tolerant of less than ideal layouts. For maximum performance (for example, fast settling time) use a ground plane, short lead lengths and RF-quality bypass capacitors (0.01μF to 0.1μF). For high drive current applications use low ESR bypass capacitors (1μF to 10μF tantalum). Sockets should be avoided when maximum frequency performance is required. For more details see Design Note 50. Feedback resistors greater than 5k are not recommended because a pole is formed with the input capacitance which can cause peaking or oscillations. Stray capacitance on Pin 5 should be minimized. Bias current cancellation circuitry is employed on the inputs of the LT1222 so the input bias current and input offset current have identical specifications. For this reason, matching the impedance on the inputs to reduce bias current errors is not necessary.

1222fc

APPLICATIONS INFORMATION

Output Clamping

Access to the internal compensation node at Pin 5 allows the output swing of the LT1222 to be clamped. An example is shown on the first page of this data sheet. The compensation node is approximately one diode drop above the output and can source or sink 1.2mA. Back-to-back Schottky diodes clamp Pin 5 to a diode drop above ground so the output is clamped to $\pm 0.5V$ (the drop of the Schottkys at 1.2mA). The diode reference is bypassed for good AC response. This circuit is useful for amplifying the voltage at false sum nodes used in settling time measurements.

Capacitive Loading

The LT1222 is stable with capacitive loads. This is accomplished by sensing the load induced output pole and adding compensation at the amplifier gain node. As the capacitive load increases, both the bandwidth and phase margin decrease. There will be peaking in the frequency domain as shown in the curve of Frequency Response vs Capacitive Load. The small-signal transient response will have more overshoot as shown in the photo of the small-signal response with 1000pF load. The large-signal response with a 10,000pF load shows the output slew rate being limited to $4V/\mu s$ by the short-circuit current. The LT1222 can drive coaxial cable directly, but for best pulse fidelity a resistor of value equal to the characteristic impedance of the cable (i.e., 75Ω) should be placed in series with the output. The other end of the cable should be terminated with the same value resistor to ground.

Compensation

The LT1222 has a typical gain-bandwidth product of 500MHz which allows it to have wide bandwidth in high gain configurations (i.e., in a gain of 100, it will have a bandwidth of about 5MHz). For added flexibility the amplifier frequency response may be adjusted by adding capacitance from Pin 5 to ground. The compensation capacitor

may be used to reduce overshoot, to allow the amplifier to be used in lower noise gains, or simply to reduce bandwidth. Table 1 shows gain and compensation capacitor versus $-3dB$ bandwidth, maximum frequency peaking and small-signal overshoot.

Table 1

A_V	C_C (pF)	f_{-3dB} (MHz)	Max Peaking (dB)	Overshoot (%)
-1	30	99	4.2	36
-1	50	70	0.9	13
-1	82	32	0	0
-1	150	13	0	0
5	10	140	3.8	35
5	20	100	0	5
5	30	34	0	1
5	50	15	0	0
10	0	150	9.5	45
10	5	111	0.2	10
10	10	40	0	2
10	20	17	0	0
20	0	82	0.1	10
20	5	24	0	0
20	10	14	0	0

For frequencies $< 10MHz$ the frequency response of the amplifier is approximately:

$$f = 1/[2\pi \cdot 53\Omega \cdot (C_C + 6pF) \cdot (\text{Noise Gain})]$$

The slew rate is affected as follows:

$$SR = 1.2mA/(C_C + 6pF)$$

An example would be a gain of -10 (noise gain of 11) and $C_C = 20pF$ which has 10.5MHz bandwidth and $46V/\mu s$ slew rate. It should be noted that the LT1222 is not stable in $A_V = 1$ unless $C_C = 50pF$ and a 1k resistor is used as the feedback resistor. The 1k and input capacitance increase the noise gain at frequency to aid stability.

TYPICAL APPLICATIONS

V_{OS} Null Loop

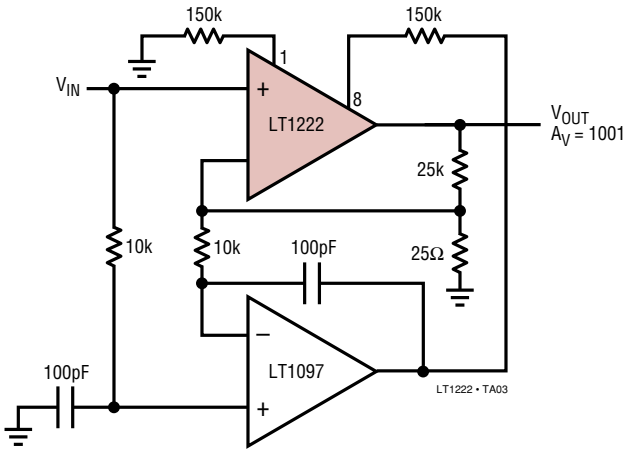

Two Op Amp Instrumentation Amplifier

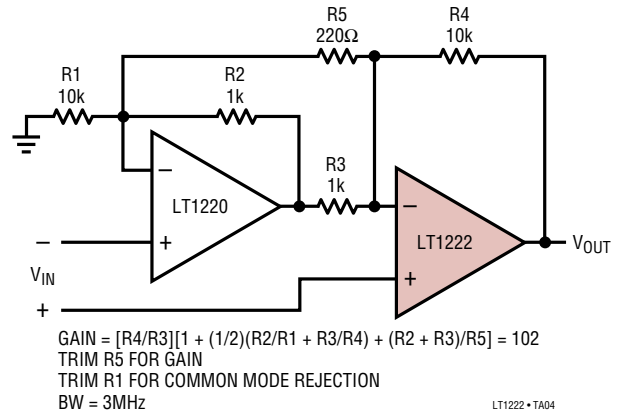

SIMPLIFIED SCHEMATIC

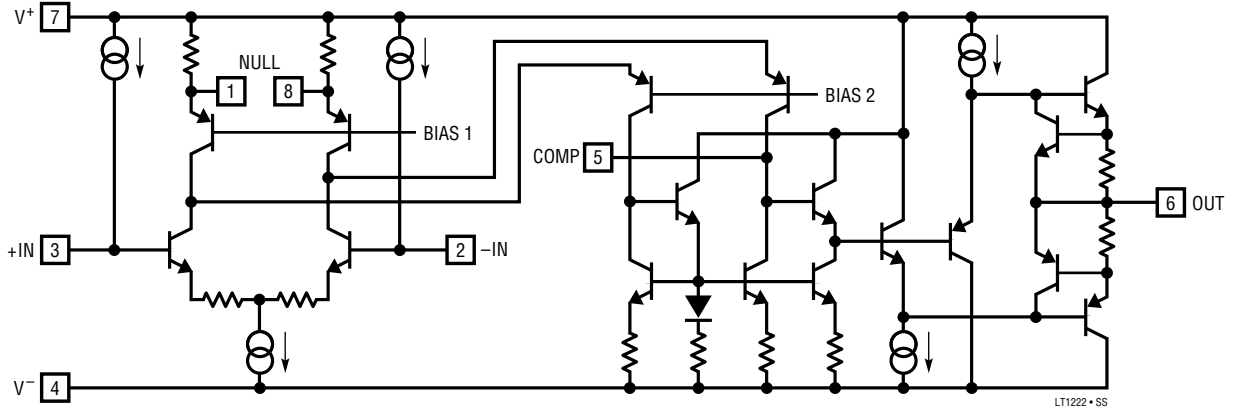

PACKAGE DESCRIPTION

N8 Package
8-Lead PDIP (Narrow .300 Inch)
 (Reference LTC DWG # 05-08-1510)

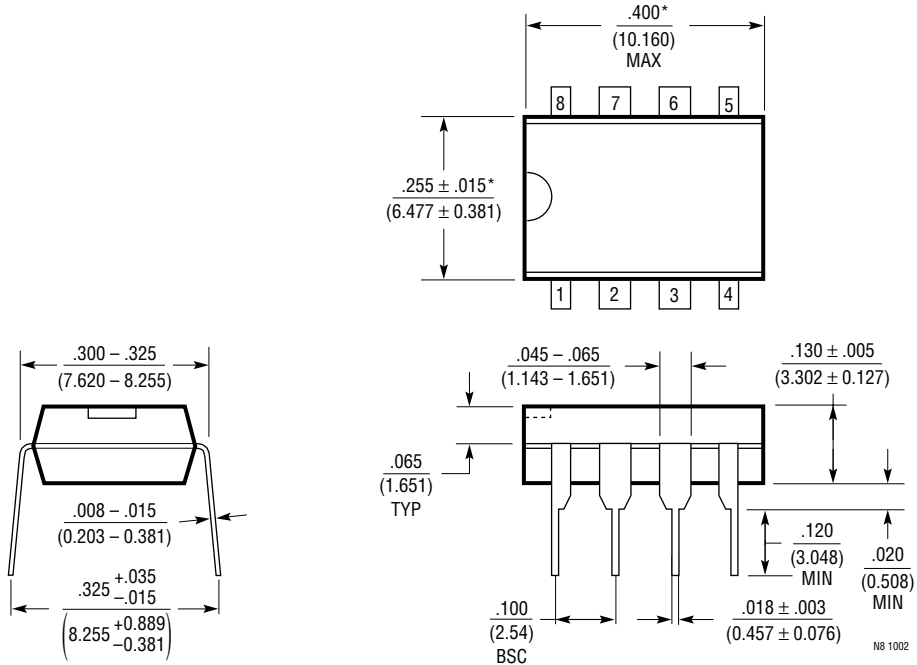

NOTE:
 1. DIMENSIONS ARE $\frac{\text{INCHES}}{\text{MILLIMETERS}}$
 *THESE DIMENSIONS DO NOT INCLUDE MOLD FLASH OR PROTRUSIONS.
 MOLD FLASH OR PROTRUSIONS SHALL NOT EXCEED .010 INCH (0.254mm)

PACKAGE DESCRIPTION

S8 Package
8-Lead Plastic Small Outline (Narrow .150 Inch)
 (Reference LTC DWG # 05-08-1610)

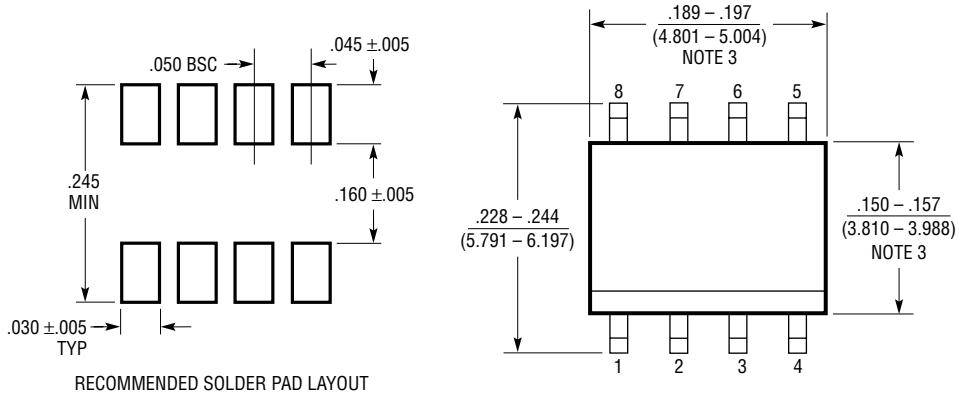

RECOMMENDED SOLDER PAD LAYOUT

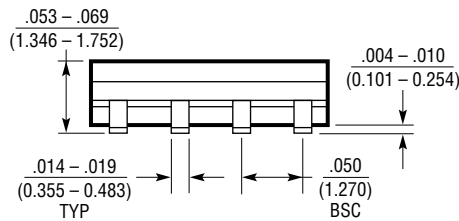
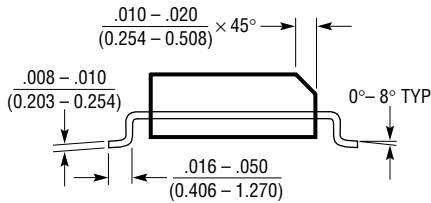

- NOTE:
 1. DIMENSIONS IN $\frac{\text{INCHES}}{\text{MILLIMETERS}}$
 2. DRAWING NOT TO SCALE
 3. THESE DIMENSIONS DO NOT INCLUDE MOLD FLASH OR PROTRUSIONS.
 MOLD FLASH OR PROTRUSIONS SHALL NOT EXCEED .006" (0.15mm)

S08 0303

LT1222

RELATED PARTS

PART NUMBER	DESCRIPTION	COMMENTS
LT1220	45MHz, 250V/ μ s Amplifier	Unity Gain Stable Version of the LT1222
LT1221	150MHz, 250V/ μ s Amplifier	$A_V \geq 4$ Version of the LT1222

1222fc

Looking for pricing, stock, or lifecycle information?

Click below to explore more details on WIN SOURCE:

 [View LT1222IS8#PBF on WIN SOURCE](#)

 [Linear Technology](#) Information

Optimize Your Supply Chain with WIN SOURCE Solutions

-  Global Sourcing Solution
-  Obsolete Management
-  Cost Control Management
-  Shortage Management
-  Alternative Solution
-  Excess Inventory Management