



**THE DATASHEET OF
LMV393DR2G**



LMV331, NCV331, LMV393, LMV339

Single, Dual, Quad General Purpose, Low Voltage Comparators

The LMV331 is a CMOS single channel, general purpose, low voltage comparator. The LMV393 and LMV339 are dual and quad channel versions, respectively. The LMV331/393/339 are specified for 2.7 V to 5 V performance, have excellent input common-mode range, low quiescent current, and are available in several space saving packages.

The LMV331 is available in 5-pin SC-70 and TSOP-5 packages. The LMV393 is available in a 8-pin Micro8™, SOIC-8, and a UDFN8 package, and the LMV339 is available in a SOIC-14 and a TSSOP-14 package.

The LMV331/393/339 are cost effective solutions for applications where space saving, low voltage operation, and low power are the primary specifications in circuit design for portable applications.

Features

- Guaranteed 2.7 V and 5 V Performance
- Input Common-mode Voltage Range Extends to Ground
- Open Drain Output for Wired-OR Applications
- Low Quiescent Current: 60 μ A/channel TYP @ 5 V
- Low Saturation Voltage 200 mV TYP @ 5 V
- Propagation Delay 200 ns TYP @ 5 V
- NCV Prefix for Automotive and Other Applications Requiring Unique Site and Control Change Requirements; AEC-Q100 Qualified and PPAP Capable
- These Devices are Pb-Free, Halogen Free/BFR Free and are RoHS Compliant

Typical Applications

- Battery Monitors
- Notebooks and PDA's
- General Purpose Portable Devices
- General Purpose Low Voltage Applications

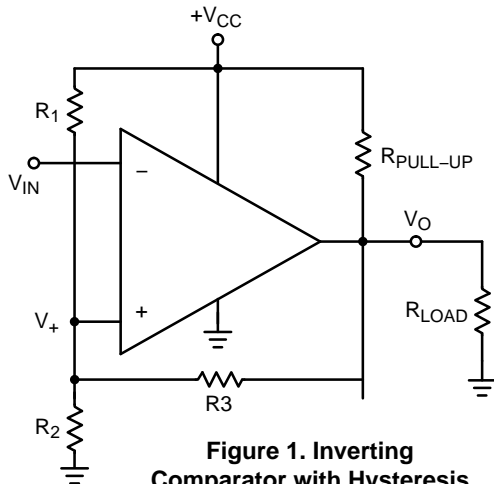

Figure 1. Inverting Comparator with Hysteresis



ON Semiconductor®

www.onsemi.com



SC-70
CASE 419A

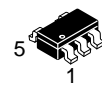

TSOP-5
CASE 483



Micro8
CASE 846A



SOIC-8
CASE 751



UDFN8
CASE 517AJ



SOIC-14
CASE 751A

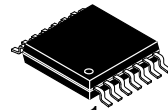

TSSOP-14
CASE 948G

ORDERING INFORMATION

See detailed ordering and shipping information in the package dimensions section on page 13 of this data sheet.

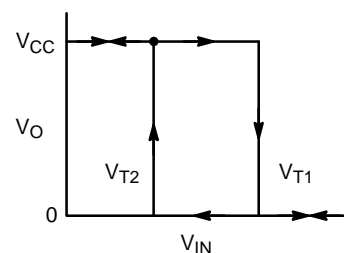
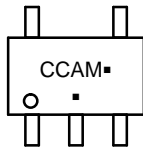

Figure 2. Hysteresis Curve

LMV331, NCV331, LMV393, LMV339

MARKING DIAGRAMS

**SC-70
CASE 419A**



CCA = Specific Device Code
M = Date Code
▪ = Pb-Free Package
(Note: Microdot may be in either location)

**TSOP-5
CASE 483**

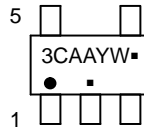

A = Assembly Location
Y = Year
W = Work Week
▪ = Pb-Free Package
(Note: Microdot may be in either location)

**UDFN8
CASE 517AJ**

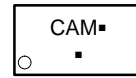

CA = Specific Device Code
M = Date Code
▪ = Pb-Free Package
(Note: Microdot may be in either location)

**Micro8
CASE 846A**

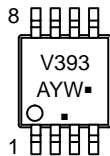

A = Assembly Location
Y = Year
W = Work Week
▪ = Pb-Free Package
(Note: Microdot may be in either location)

**SOIC-8
CASE 751**

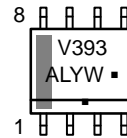

A = Assembly Location
L = Wafer Lot
Y = Year
W = Work Week
▪ = Pb-Free Package

**SOIC-14
CASE 751A**

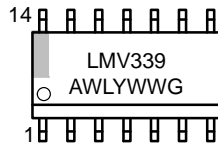

A = Assembly Location
WL = Wafer Lot
Y = Year
WW = Work Week
G = Pb-Free Package

**TSSOP-14
CASE 948G**

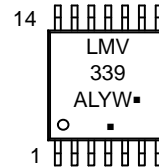

A = Assembly Location
L = Wafer Lot
Y = Year
W = Work Week
▪ = Pb-Free Package
(Note: Microdot may be in either location)

PACKAGE PINOUTS

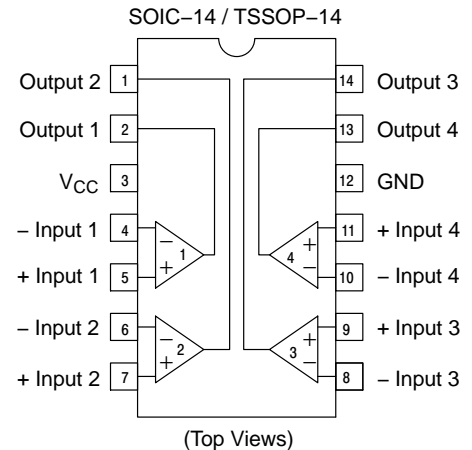
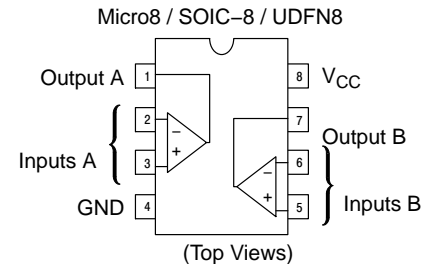
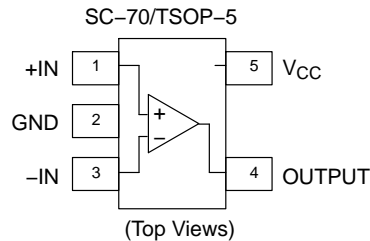

LMV331, NCV331, LMV393, LMV339

MAXIMUM RATINGS

Symbol	Rating	Value	Unit
V _S	Voltage on any Pin (referred to V ⁻ pin)	5.5	V
V _{IDR}	Input Differential Voltage Range	±Supply Voltage	V
T _J	Maximum Junction Temperature	150	°C
T _A	Operating Ambient Temperature Range LMV331, LMV393, LMV339 NCV331 (Note 3)	-40 to 85 -40 to 125	°C
T _{stg}	Storage Temperature Range	-65 to 150	°C
T _L	Mounting Temperature (Infrared or Convection (1/16" From Case for 30 Seconds))	260	°C
V _{ESD}	ESD Tolerance (Note 1) Machine Model Human Body Model	100 1000	V

Stresses exceeding those listed in the Maximum Ratings table may damage the device. If any of these limits are exceeded, device functionality should not be assumed, damage may occur and reliability may be affected.

RECOMMENDED OPERATING CONDITIONS

Symbol	Parameter	Value	Unit
V _{CC}	Supply Voltage Temperature Range (Note 2)	2.7 to 5.0	V
θ _{JA}	Thermal Resistance SC-70 TSOP-5 Micro8 SOIC-8 UDFN8 SOIC-14 TSSOP-14	280 333 238 212 350 156 190	°C/W

- Human Body Model, applicable std. MIL-STD-883, Method 3015.7. Machine Model, applicable std. JESD22-A115-A (ESD MM std. of JEDEC) Field-Induced Charge-Device Model, applicable std. JESD22-C101-C (ESD FICDM std. of JEDEC).
- The maximum power dissipation is a function of T_{J(MAX)}, θ_{JA}. The maximum allowable power dissipation at any ambient temperature is P_D = (T_{J(MAX)} - T_A)/θ_{JA}. All numbers apply for packages soldered directly onto a PC board.
- NCV prefix is qualified for automotive usage.

LMV331, NCV331, LMV393, LMV339

2.7 V DC ELECTRICAL CHARACTERISTICS (All limits are guaranteed for $T_A = 25^\circ\text{C}$, $V^+ = 2.7\text{ V}$, $V^- = 0\text{ V}$, $V_{CM} = 1.35\text{ V}$ unless otherwise noted.)

Parameter	Symbol	Condition	Min	Typ	Max	Unit
Input Offset Voltage	V_{IO}			1.7	9	mV
Input Offset Voltage Average Drift	$T_C V_{IO}$			5		$\mu\text{V}/^\circ\text{C}$
Input Bias Current (Note 4)	I_B			< 1		nA
Input Offset Current (Note 4)	I_{IO}			< 1		nA
Input Voltage Range	V_{CM}			0 to 2		V
Saturation Voltage	V_{SAT}	$I_{SINK} \leq 1\text{ mA}$		120		mV
Output Sink Current	I_O	$V_O \leq 1.5\text{ V}$	5	23		mA
Supply Current	I_{CC}			40 40 70 140	100 100 140 200	μA
	LMV331 NCV331 LMV393 LMV339					

2.7 V AC ELECTRICAL CHARACTERISTICS ($T_A = 25^\circ\text{C}$, $V^+ = 2.7\text{ V}$, $R_L = 5.1\text{ k}\Omega$, $V^- = 0\text{ V}$ unless otherwise noted.)

Parameter	Symbol	Condition	Min	Typ	Max	Unit
Propagation Delay – High to Low	t_{PHL}	Input Overdrive = 10 mV Input Overdrive = 100 mV		1000 500		ns
Propagation Delay – Low to High	t_{PLH}	Input Overdrive = 10 mV Input Overdrive = 100 mV		800 200		ns

4. Guaranteed by design and/or characterization.

LMV331, NCV331, LMV393, LMV339

5.0 V DC ELECTRICAL CHARACTERISTICS (All limits are guaranteed for $T_A = 25^\circ\text{C}$, $V^+ = 5\text{ V}$, $V^- = 0\text{ V}$, $V_{CM} = 2.5\text{ V}$ unless otherwise noted. Limits over temperature are guaranteed by design and/or characterization.)

Parameter	Symbol	Condition (Note 6)	Min	Typ	Max	Unit
Input Offset Voltage	V_{IO}	$T_A = T_{LO}$ to T_{HIGH}		1.7	9	mV
Input Offset Voltage Average Drift		$T_A = T_{LO}$ to T_{HIGH}		5		$\mu\text{V}/^\circ\text{C}$
Input Bias Current (Note 5)	I_B	$T_A = T_{LO}$ to T_{HIGH}		< 1		nA
Input Offset Current (Note 5)	I_{IO}	$T_A = T_{LO}$ to T_{HIGH}		< 1		nA
Input Voltage Range	V_{CM}			0 to 4.2		V
Voltage Gain (Note 5)	A_V		20	50		V/mV
Saturation Voltage	V_{SAT}	$I_{SINK} = 10\text{ mA}$ $T_A = T_{LO}$ to T_{HIGH}		200	400 700	mV
Output Sink Current	I_O	$V_O \leq 1.5\text{ V}$	10	84		mA
Supply Current LMV331	I_{CC}	$T_A = T_{LO}$ to T_{HIGH}		60	120 150	μA
Supply Current LMV393	I_{CC}	$T_A = T_{LO}$ to T_{HIGH}		100	200 250	μA
Supply Current LMV339	I_{CC}	$T_A = T_{LO}$ to T_{HIGH}		170	300 350	μA
Output Leakage Current (Note 5)		$T_A = T_{LO}$ to T_{HIGH}		0.003	1	μA

5.0 V AC ELECTRICAL CHARACTERISTICS ($T_A = 25^\circ\text{C}$, $V^+ = 5\text{ V}$, $R_L = 5.1\text{ k}\Omega$, $V^- = 0\text{ V}$ unless otherwise noted.)

Parameter	Symbol	Condition	Min	Typ	Max	Unit
Propagation Delay – High to Low	t_{PHL}	Input Overdrive = 10 mV Input Overdrive = 100 mV		1500 900		ns
Propagation Delay – Low to High	t_{PLH}	Input Overdrive = 10 mV Input Overdrive = 100 mV		800 200		ns

5. Guaranteed by design and/or characterization.
6. For LMV331, LMV393, LMV339: $T_A = -40^\circ\text{C}$ to 85°C
For NCV331: $T_A = -40^\circ\text{C}$ to 125°C

LMV331, NCV331, LMV393, LMV339

TYPICAL CHARACTERISTICS

($V_{CC} = 5.0\text{ V}$, $T_A = 25^\circ\text{C}$, $R_L = 5\text{ k}\Omega$ unless otherwise specified)

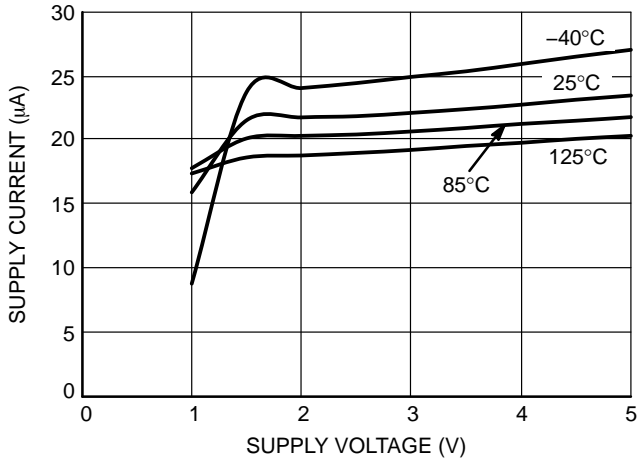

Figure 3. Supply Current vs. Supply Voltage (Output High)

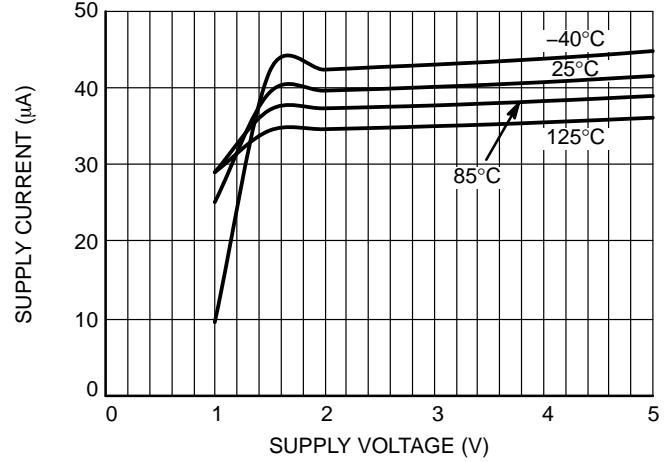

Figure 4. Supply Current vs. Supply Voltage (Output Low)

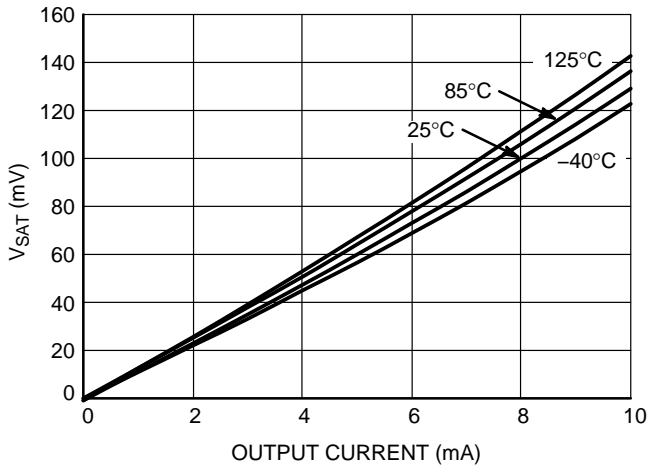

Figure 5. V_{SAT} vs. Output Current at $V_{CC} = 2.7\text{ V}$

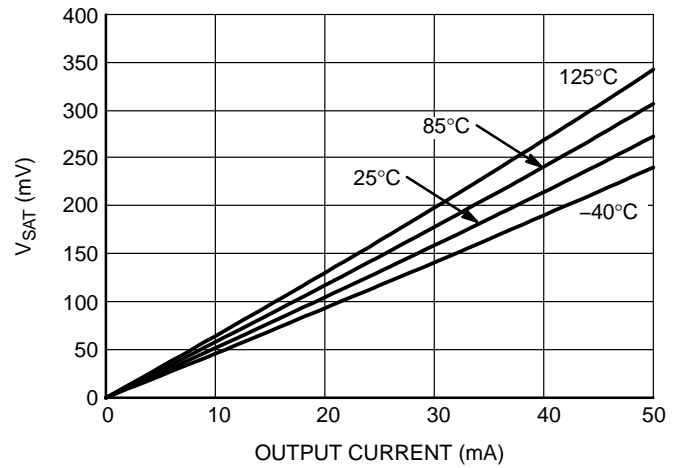

Figure 6. V_{SAT} vs. Output Current at $V_{CC} = 5.0\text{ V}$

LMV331, NCV331, LMV393, LMV339

NEGATIVE TRANSITION INPUT – $V_{CC} = 2.7\text{ V}$

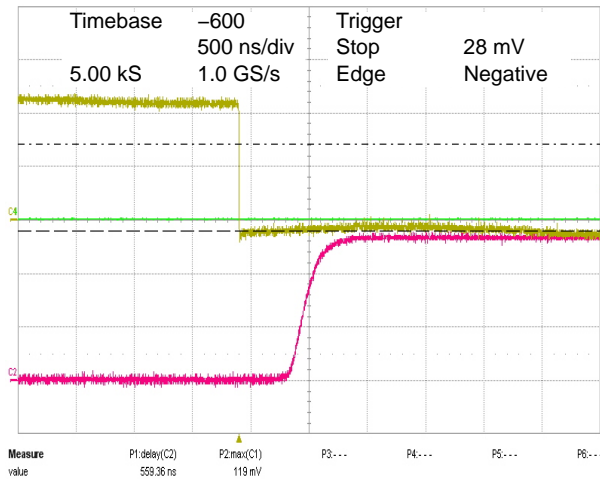

Figure 7. 10 mV Overdrive

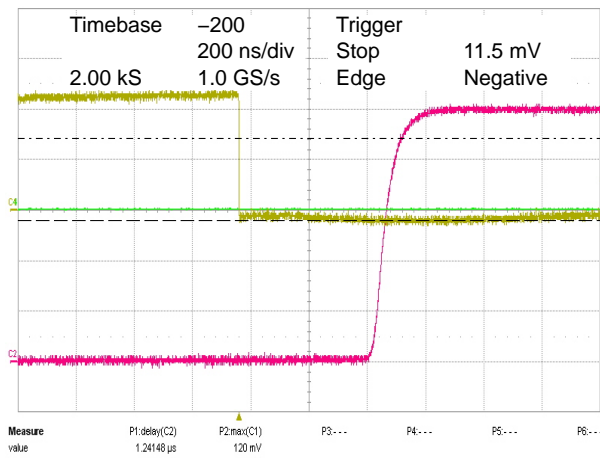

Figure 8. 20 mV Overdrive

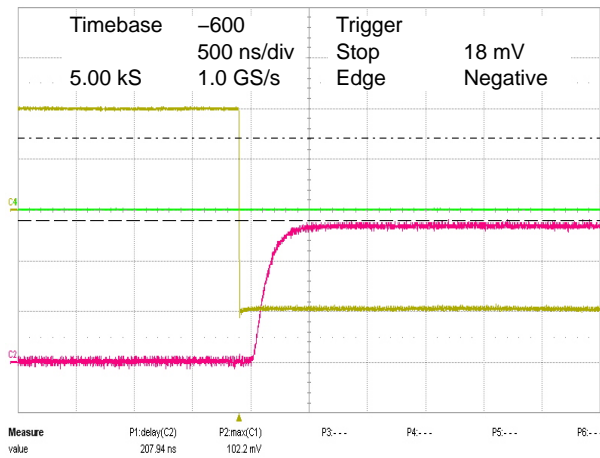

Figure 9. 100 mV Overdrive

LMV331, NCV331, LMV393, LMV339

POSITIVE TRANSITION INPUT – $V_{CC} = 2.7\text{ V}$

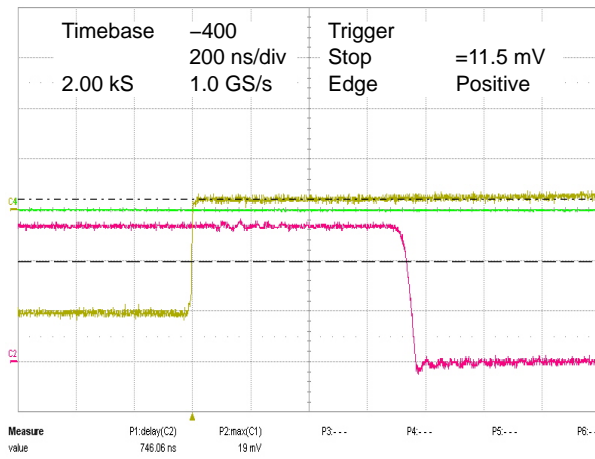

Figure 10. 10 mV Overdrive

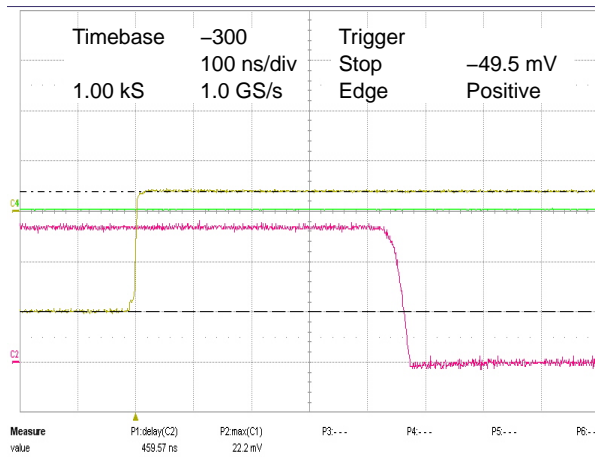

Figure 11. 20 mV Overdrive

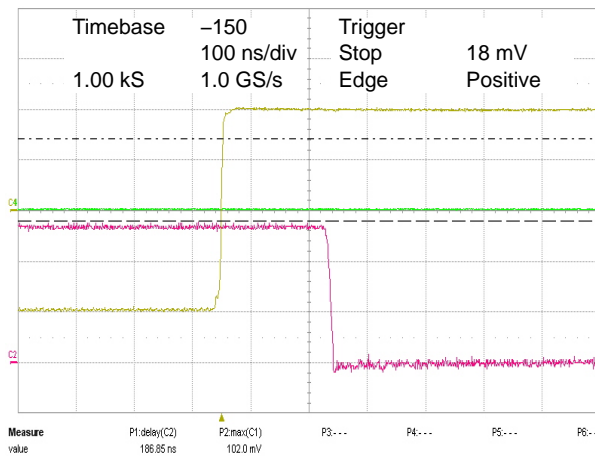

Figure 12. 100 mV Overdrive

LMV331, NCV331, LMV393, LMV339

NEGATIVE TRANSITION INPUT – $V_{CC} = 5.0\text{ V}$

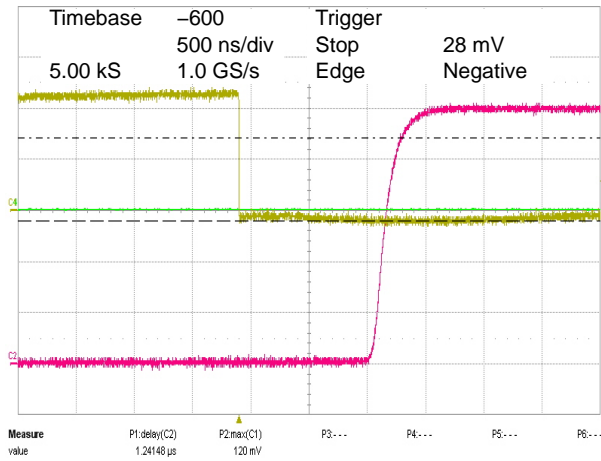

Figure 13. 10 mV Overdrive

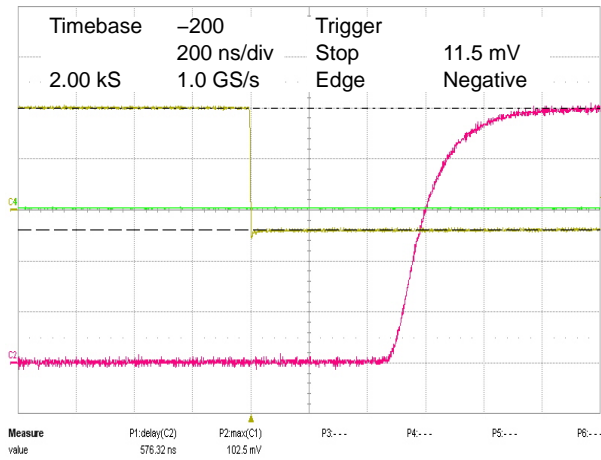

Figure 14. 20 mV Overdrive

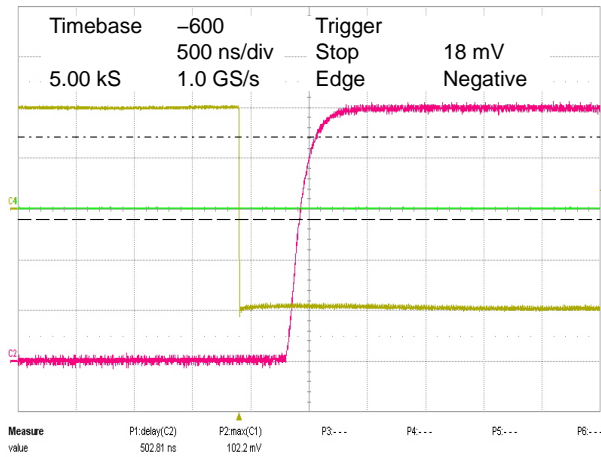

Figure 15. 100 mV Overdrive

LMV331, NCV331, LMV393, LMV339

POSITIVE TRANSITION INPUT – $V_{CC} = 5.0\text{ V}$

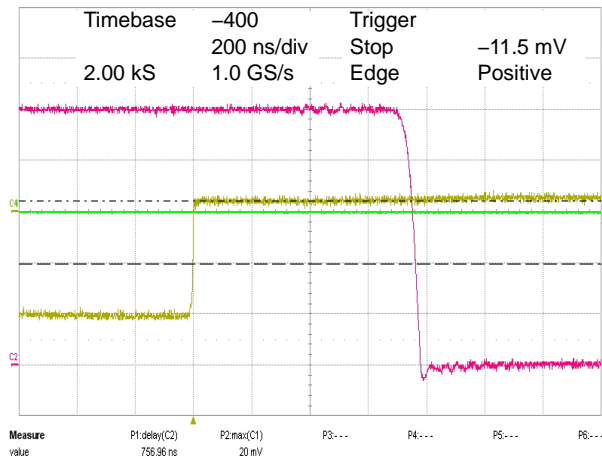

Figure 16. 10 mV Overdrive

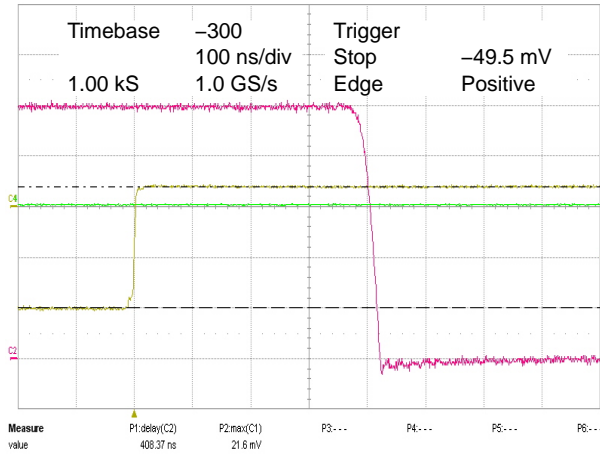

Figure 17. 20 mV Overdrive

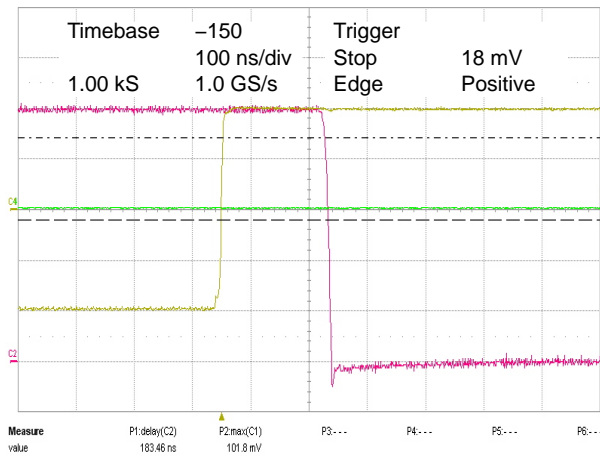

Figure 18. 100 mV Overdrive

APPLICATION CIRCUITS

Basic Comparator Operation

The basic operation of a comparator is to compare two input voltage signals, and produce a digital output signal by determining which input signal is higher. If the voltage on the non-inverting input is higher, then the internal output transistor is off and the output will be high. If the voltage on the inverting input is higher, then the output transistor will be on and the output will be low. The LMV331/393/339 has an open-drain output stage, so a pull-up resistor to a positive supply voltage is required for the output to switch properly.

The size of the pull-up resistor is recommended to be between 1 kΩ and 10 kΩ. This range of values will balance two key factors; i.e., power dissipation and drive capability for interface circuitry.

Figure 19 illustrates the basic operation of a comparator and assumes dual supplies. The comparator compares the input voltage (V_{IN}) on the non-inverting input to the reference voltage (V_{REF}) on the inverting input. If V_{IN} is less than V_{REF} , the output voltage (V_O) will be low. If V_{IN} is greater than V_{REF} , then V_O will be high.

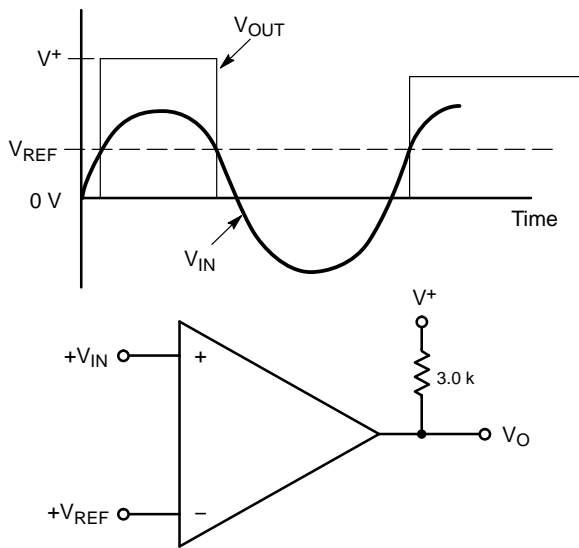

Figure 19.

Comparators and Stability

A common problem with comparators is oscillation due to their high gain. The basic comparator configuration in Figure 19 may oscillate if the differential voltage between the input pins is close to the device's offset voltage. This can happen if the input signal is moving slowly through the comparator's switching threshold or if unused channels are connected to the same potential for termination of unused channels. One way to eliminate output oscillations or 'chatter' is to include external hysteresis in the circuit design.

Inverting Configuration with Hysteresis

An inverting comparator with hysteresis is shown in Figure 20.

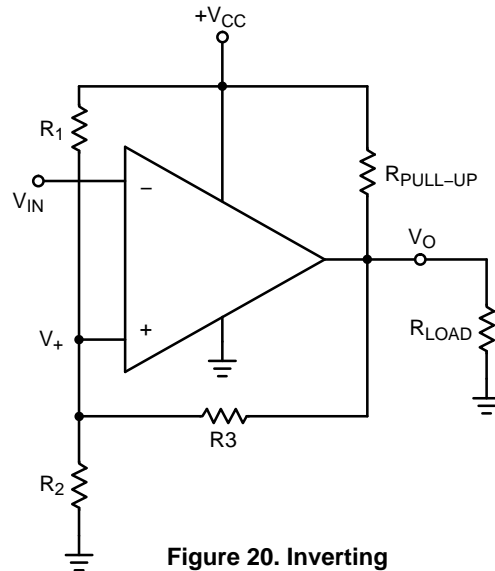

Figure 20. Inverting Comparator with Hysteresis

When V_{IN} is less than the voltage at the non-inverting node, V_+ , the output voltage will be high. When V_{IN} is greater than the voltage at V_+ , then the output will be low. The hysteresis band (Figure 21) created from the resistor network is defined as:

$$\Delta V_+ = V_{T1} - V_{T2}$$

where V_{T1} and V_{T2} are the lower and upper trip points, respectively.

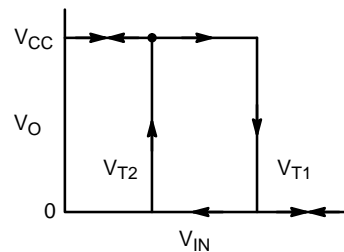

Figure 21.

V_{T1} is calculated by assuming that the output of the comparator is pulled up to supply when high. The resistances R_1 and R_3 can be viewed as being in parallel which is in series with R_2 (Figure 22). Therefore V_{T1} is:

$$V_{T1} = \frac{V_{CC} R_2}{(R_1 \parallel R_3) + R_2}$$

V_{T2} is calculated by assuming that the output of the comparator is at ground potential when low. The resistances R_2 and R_3 can be viewed as being in parallel which is in series with R_1 (Figure 23). Therefore V_{T2} is:

$$V_{T2} = \frac{V_{CC}(R_2 \parallel R_3)}{R_1 + (R_2 \parallel R_3)}$$

LMV331, NCV331, LMV393, LMV339

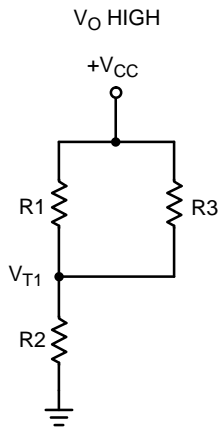

Figure 22.

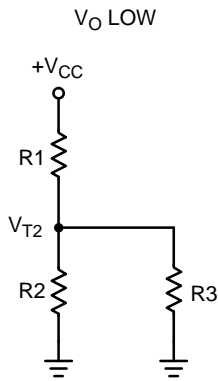

Figure 23.

When V_{IN} is much less than the voltage at the inverting input (V_{REF}), then the output is low. R_2 can then be viewed as being connected to ground (Figure 26). To calculate the voltage required at V_{IN} to trip the comparator high, the following equation is used:

$$V_{in1} = \frac{V_{ref} (R_1 + R_2)}{R_2}$$

When the output is high, V_{IN} must be less than or equal to V_{REF} ($V_{IN} \leq V_{REF}$) before the output will be low again (Figure 27). The following equation is used to calculate the voltage at V_{IN} to switch the output back to the low state:

$$V_{in2} = \frac{V_{ref} (R_1 + R_2) - V_{CC} R_1}{R_2}$$

Non-inverting Configuration with Hysteresis

A non-inverting comparator is shown in Figure 24.

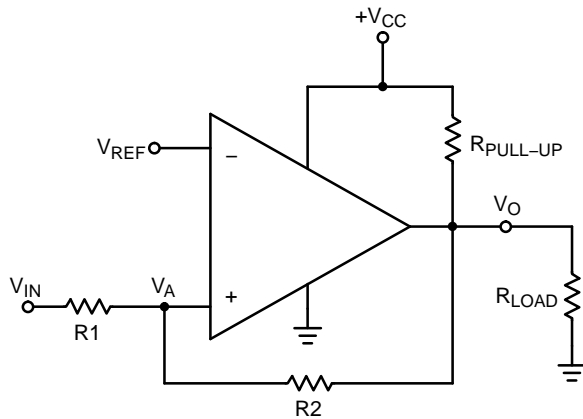

Figure 24.

The hysteresis band (Figure 25) of the non-inverting configuration is defined as follows:

$$\Delta V_{in} = V_{CC} R_1 / R_2$$

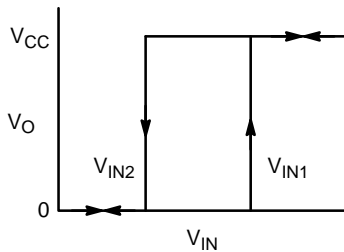

Figure 25.

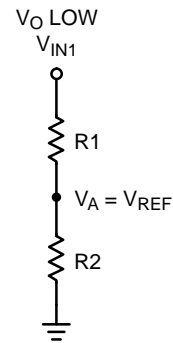

Figure 26.

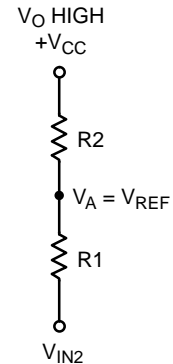

Figure 27.

Termination of Unused Inputs

Proper termination of unused inputs is a good practice to keep the output from ‘chattering.’ For example, if one channel of a dual or quad package is not being used, then the inputs must be connected to a defined state. The recommended connections would be to tie one input to V_{CC} and the other input to ground.

LMV331, NCV331, LMV393, LMV339

ORDERING INFORMATION

Order Number	Number of Channels	Specific Device Marking	Package Type	Shipping†
LMV331SQ3T2G	Single	CCA	SC-70 (Pb-Free)	3000 / Tape & Reel
LMV331SN3T1G	Single	3CA	TSOP-5 (Pb-Free)	3000 / Tape & Reel
NCV331SN3T1G	Single	3CA	TSOP-5 (Pb-Free)	3000 / Tape & Reel
LMV393DMR2G	Dual	V393	Micro8 (Pb-Free)	4000 / Tape & Reel
LMV393DR2G	Dual	V393	SOIC-8 (Pb-Free)	2500 / Tape & Reel
LMV393MUTAG	Dual	CA	UDFN8 (Pb-Free)	3000 / Tape & Reel
LMV339DR2G	Quad	LMV339	SOIC-14 (Pb-Free)	2500 / Tape & Reel
LMV339DTBR2G	Quad	LMV 339	TSSOP-14 (Pb-Free)	2500 / Tape & Reel

†For information on tape and reel specifications, including part orientation and tape sizes, please refer to our Tape and Reel Packaging Specifications Brochure, BRD8011/D.

*Contact factory.

LMV331, NCV331, LMV393, LMV339

PACKAGE DIMENSIONS

SC-88A (SC-70-5/SOT-353)
CASE 419A-02
ISSUE L

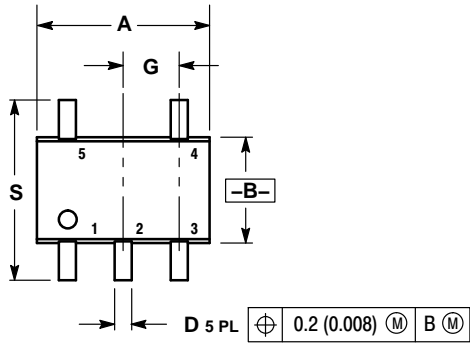

NOTES:

1. DIMENSIONING AND TOLERANCING PER ANSI Y14.5M, 1982.
2. CONTROLLING DIMENSION: INCH.
3. 419A-01 OBSOLETE. NEW STANDARD 419A-02.
4. DIMENSIONS A AND B DO NOT INCLUDE MOLD FLASH, PROTRUSIONS, OR GATE BURRS.

DIM	INCHES		MILLIMETERS	
	MIN	MAX	MIN	MAX
A	0.071	0.087	1.80	2.20
B	0.045	0.053	1.15	1.35
C	0.031	0.043	0.80	1.10
D	0.004	0.012	0.10	0.30
G	0.026 BSC		0.65 BSC	
H	---	0.004	---	0.10
J	0.004	0.010	0.10	0.25
K	0.004	0.012	0.10	0.30
N	0.008 REF		0.20 REF	
S	0.079	0.087	2.00	2.20

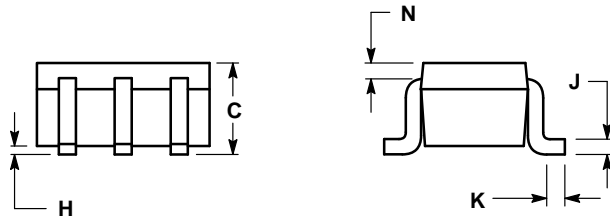

SOLDER FOOTPRINT

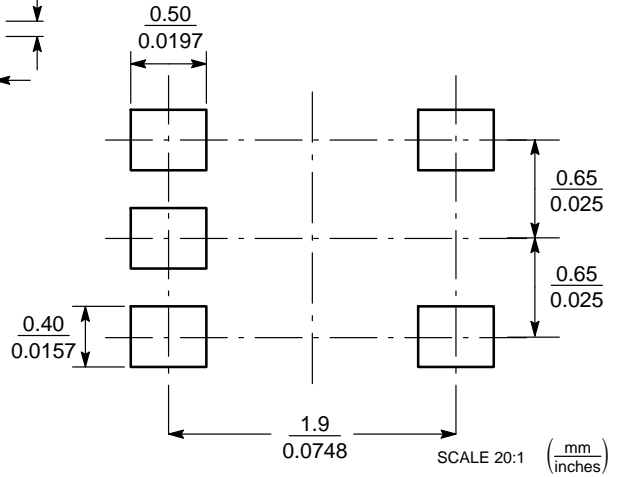

LMV331, NCV331, LMV393, LMV339

PACKAGE DIMENSIONS

TSOP-5 CASE 483-02 ISSUE M

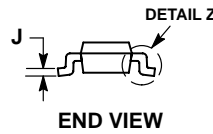
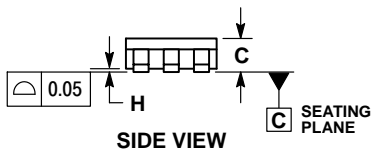
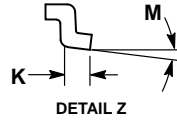
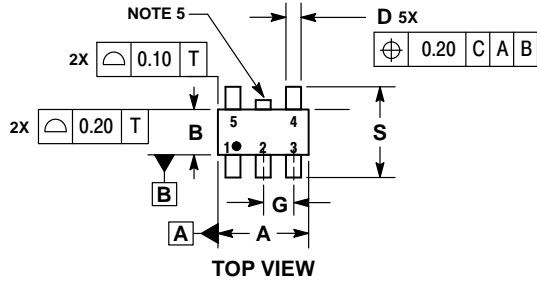

NOTES:

1. DIMENSIONING AND TOLERANCING PER ASME Y14.5M, 1994.
2. CONTROLLING DIMENSION: MILLIMETERS.
3. MAXIMUM LEAD THICKNESS INCLUDES LEAD FINISH THICKNESS. MINIMUM LEAD THICKNESS IS THE MINIMUM THICKNESS OF BASE MATERIAL.
4. DIMENSIONS A AND B DO NOT INCLUDE MOLD FLASH, PROTRUSIONS, OR GATE BURRS. MOLD FLASH, PROTRUSIONS, OR GATE BURRS SHALL NOT EXCEED 0.15 PER SIDE. DIMENSION A.
5. OPTIONAL CONSTRUCTION: AN ADDITIONAL TRIMMED LEAD IS ALLOWED IN THIS LOCATION. TRIMMED LEAD NOT TO EXTEND MORE THAN 0.2 FROM BODY.

DIM	MILLIMETERS	
	MIN	MAX
A	2.85	3.15
B	1.35	1.65
C	0.90	1.10
D	0.25	0.50
G	0.95 BSC	
H	0.01	0.10
J	0.10	0.26
K	0.20	0.60
M	0° 10°	
S	2.50	3.00

SOLDERING FOOTPRINT*

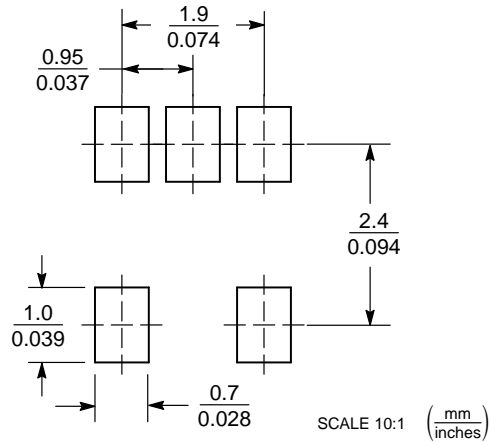

*For additional information on our Pb-Free strategy and soldering details, please download the ON Semiconductor Soldering and Mounting Techniques Reference Manual, SOLDERRM/D.

LMV331, NCV331, LMV393, LMV339

PACKAGE DIMENSIONS

UDFN8 1.8x1.2, 0.4P
CASE 517AJ
ISSUE O

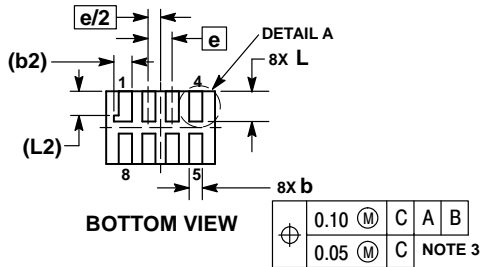
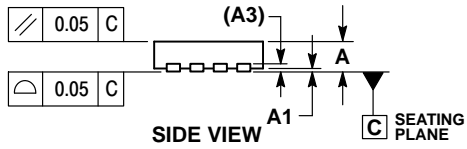
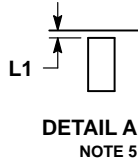
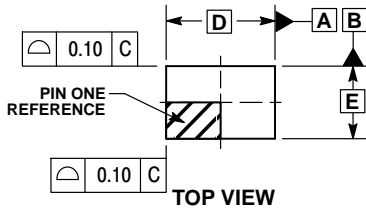

NOTES:

1. DIMENSIONING AND TOLERANCING PER ASME Y14.5M, 1994.
2. CONTROLLING DIMENSION: MILLIMETERS.
3. DIMENSION b APPLIES TO PLATED TERMINAL AND IS MEASURED BETWEEN 0.15 AND 0.30 mm FROM TERMINAL TIP.
4. MOLD FLASH ALLOWED ON TERMINALS ALONG EDGE OF PACKAGE. FLASH MAY NOT EXCEED 0.03 ONTO BOTTOM SURFACE OF TERMINALS.
5. DETAIL A SHOWS OPTIONAL CONSTRUCTION FOR TERMINALS.

DIM	MILLIMETERS	
	MIN	MAX
A	0.45	0.55
A1	0.00	0.05
A3	0.127	REF
b	0.15	0.25
b2	0.30	REF
D	1.80	BSC
E	1.20	BSC
e	0.40	BSC
L	0.45	0.55
L1	0.00	0.03
L2	0.40	REF

**MOUNTING FOOTPRINT*
SOLDERMASK DEFINED**

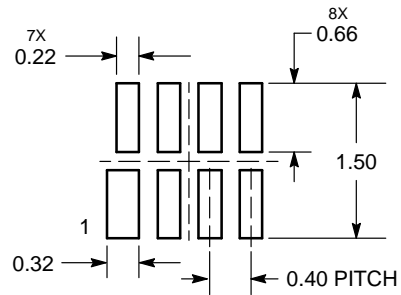

DIMENSIONS: MILLIMETERS

*For additional information on our Pb-Free strategy and soldering details, please download the ON Semiconductor Soldering and Mounting Techniques Reference Manual, SOLDERRM/D.

LMV331, NCV331, LMV393, LMV339

PACKAGE DIMENSIONS

Micro8 CASE 846A-02 ISSUE J

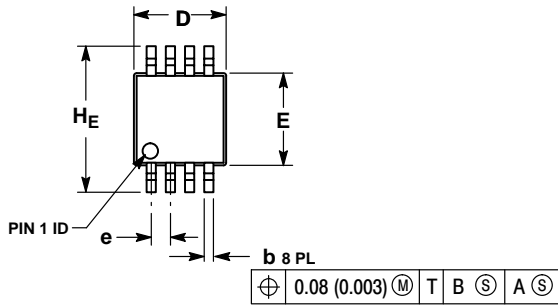

NOTES:

1. DIMENSIONING AND TOLERANCING PER ANSI Y14.5M, 1982.
2. CONTROLLING DIMENSION: MILLIMETER.
3. DIMENSION A DOES NOT INCLUDE MOLD FLASH, PROTRUSIONS OR GATE BURRS. MOLD FLASH, PROTRUSIONS OR GATE BURRS SHALL NOT EXCEED 0.15 (0.006) PER SIDE.
4. DIMENSION B DOES NOT INCLUDE INTERLEAD FLASH OR PROTRUSION. INTERLEAD FLASH OR PROTRUSION SHALL NOT EXCEED 0.25 (0.010) PER SIDE.
5. 846A-01 OBSOLETE, NEW STANDARD 846A-02.

DIM	MILLIMETERS			INCHES		
	MIN	NOM	MAX	MIN	NOM	MAX
A	—	—	1.10	—	—	0.043
A1	0.05	0.08	0.15	0.002	0.003	0.006
b	0.25	0.33	0.40	0.010	0.013	0.016
c	0.13	0.18	0.23	0.005	0.007	0.009
D	2.90	3.00	3.10	0.114	0.118	0.122
E	2.90	3.00	3.10	0.114	0.118	0.122
e	0.65 BSC			0.026 BSC		
L	0.40	0.55	0.70	0.016	0.021	0.028
HE	4.75	4.90	5.05	0.187	0.193	0.199

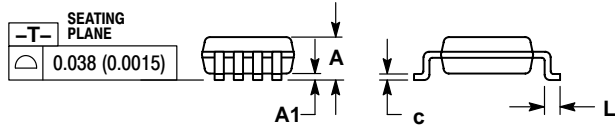

RECOMMENDED SOLDERING FOOTPRINT*

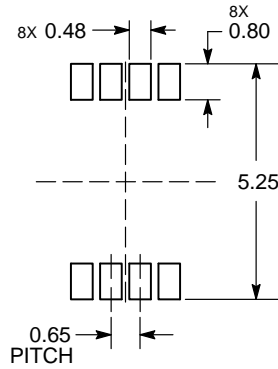

DIMENSION: MILLIMETERS

*For additional information on our Pb-Free strategy and soldering details, please download the ON Semiconductor Soldering and Mounting Techniques Reference Manual, SOLDERRM/D.

LMV331, NCV331, LMV393, LMV339

PACKAGE DIMENSIONS

SOIC-8 NB
CASE 751-07
ISSUE AK

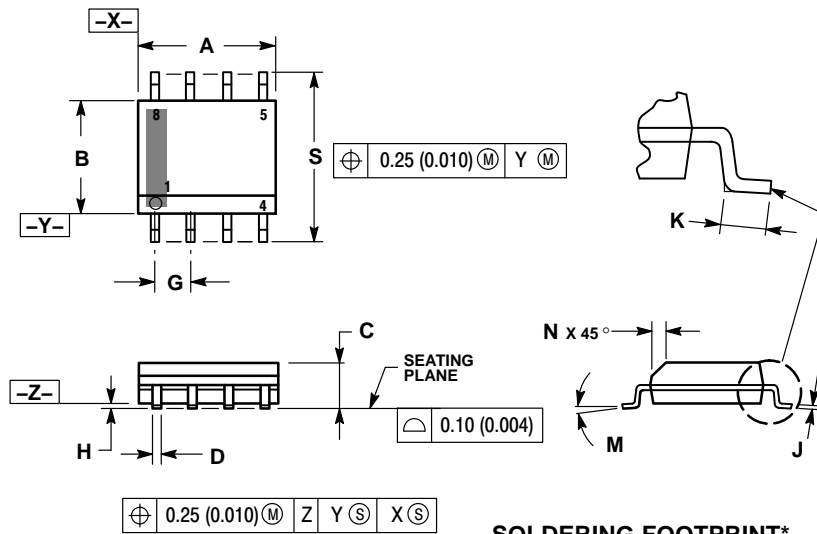

NOTES:

1. DIMENSIONING AND TOLERANCING PER ANSI Y14.5M, 1982.
2. CONTROLLING DIMENSION: MILLIMETER.
3. DIMENSION A AND B DO NOT INCLUDE MOLD PROTRUSION.
4. MAXIMUM MOLD PROTRUSION 0.15 (0.006) PER SIDE.
5. DIMENSION D DOES NOT INCLUDE DAMBAR PROTRUSION. ALLOWABLE DAMBAR PROTRUSION SHALL BE 0.127 (0.005) TOTAL IN EXCESS OF THE D DIMENSION AT MAXIMUM MATERIAL CONDITION.
6. 751-01 THRU 751-06 ARE OBSOLETE. NEW STANDARD IS 751-07.

DIM	MILLIMETERS		INCHES	
	MIN	MAX	MIN	MAX
A	4.80	5.00	0.189	0.197
B	3.80	4.00	0.150	0.157
C	1.35	1.75	0.053	0.069
D	0.33	0.51	0.013	0.020
G	1.27 BSC		0.050 BSC	
H	0.10	0.25	0.004	0.010
J	0.19	0.25	0.007	0.010
K	0.40	1.27	0.016	0.050
M	0°	8°	0°	8°
N	0.25	0.50	0.010	0.020
S	5.80	6.20	0.228	0.244

SOLDERING FOOTPRINT*

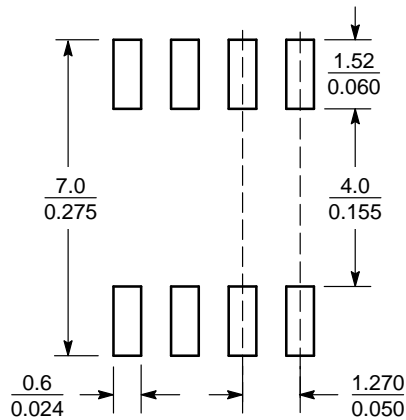

SCALE 6:1 $\left(\frac{\text{mm}}{\text{inches}}\right)$

*For additional information on our Pb-Free strategy and soldering details, please download the ON Semiconductor Soldering and Mounting Techniques Reference Manual, SOLDERRM/D.

LMV331, NCV331, LMV393, LMV339

PACKAGE DIMENSIONS

SOIC-14
CASE 751A-03
ISSUE L

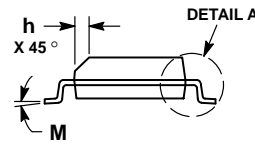
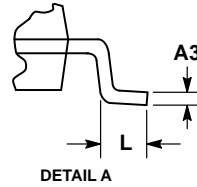
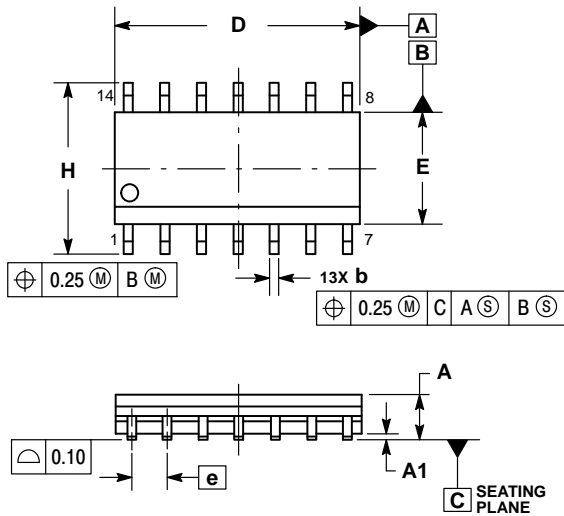

NOTES:

1. DIMENSIONING AND TOLERANCING PER ASME Y14.5M, 1994.
2. CONTROLLING DIMENSION: MILLIMETERS.
3. DIMENSION b DOES NOT INCLUDE DAMBAR PROTRUSION. ALLOWABLE PROTRUSION SHALL BE 0.13 TOTAL IN EXCESS OF AT MAXIMUM MATERIAL CONDITION.
4. DIMENSIONS D AND E DO NOT INCLUDE MOLD PROTRUSIONS.
5. MAXIMUM MOLD PROTRUSION 0.15 PER SIDE.

DIM	MILLIMETERS		INCHES	
	MIN	MAX	MIN	MAX
A	1.35	1.75	0.054	0.068
A1	0.10	0.25	0.004	0.010
A3	0.19	0.25	0.008	0.010
b	0.35	0.49	0.014	0.019
D	8.55	8.75	0.337	0.344
E	3.80	4.00	0.150	0.157
e	1.27 BSC		0.050 BSC	
H	5.80	6.20	0.228	0.244
h	0.25	0.50	0.010	0.019
L	0.40	1.25	0.016	0.049
M	0°	7°	0°	7°

SOLDERING FOOTPRINT*

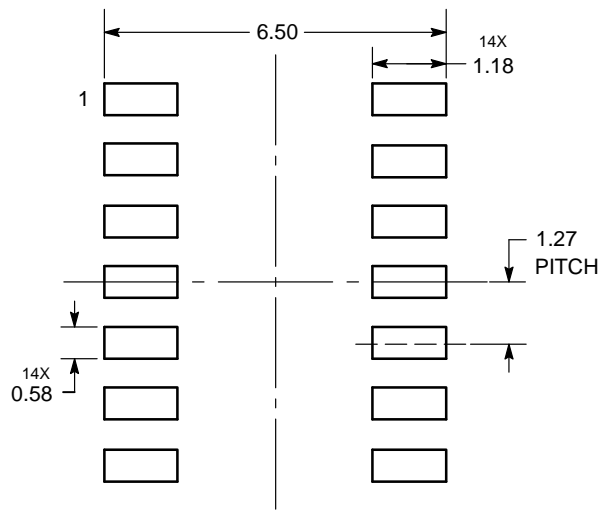

DIMENSIONS: MILLIMETERS

*For additional information on our Pb-Free strategy and soldering details, please download the ON Semiconductor Soldering and Mounting Techniques Reference Manual, SOLDERRM/D.

LMV331, NCV331, LMV393, LMV339

PACKAGE DIMENSIONS

TSSOP-14
CASE 948G
ISSUE C

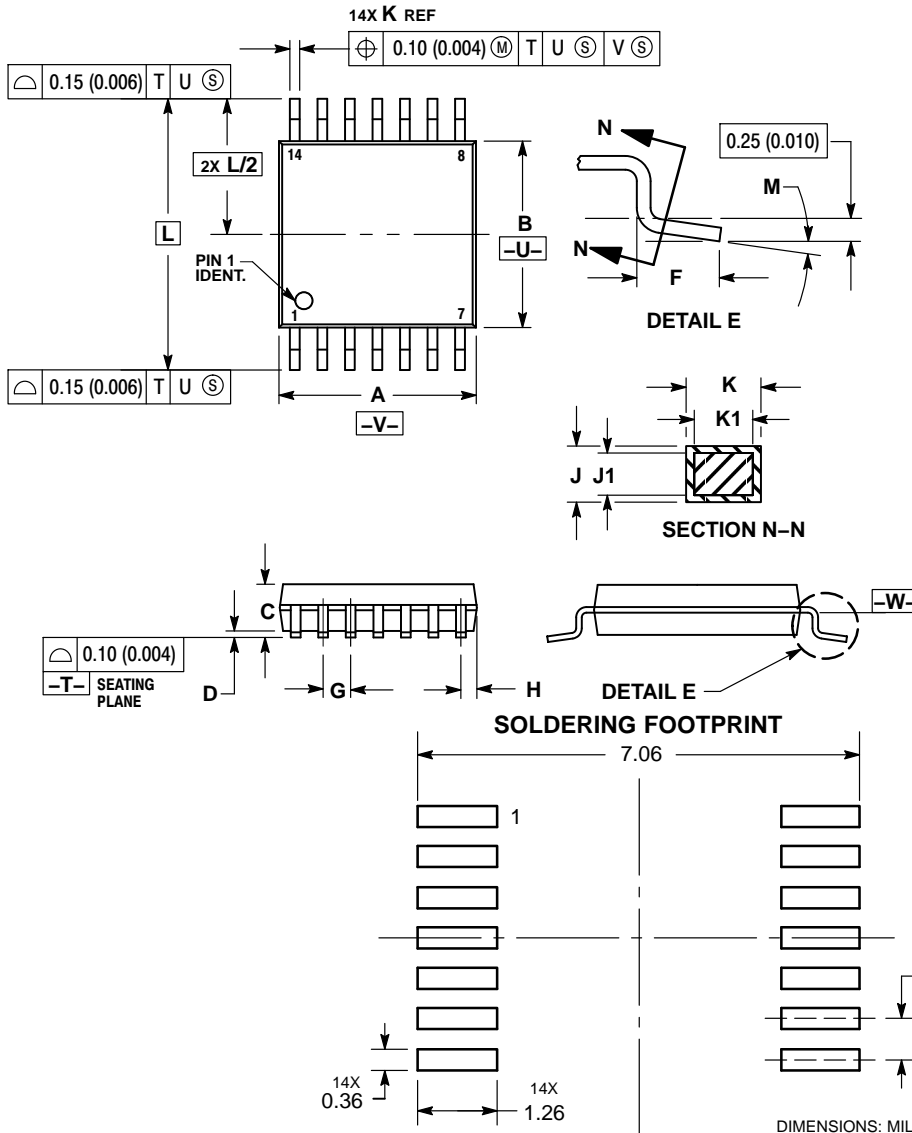

- NOTES:
1. DIMENSIONING AND TOLERANCING PER ANSI Y14.5M, 1982.
 2. CONTROLLING DIMENSION: MILLIMETER.
 3. DIMENSION A DOES NOT INCLUDE MOLD FLASH, PROTRUSIONS OR GATE BURRS. MOLD FLASH OR GATE BURRS SHALL NOT EXCEED 0.15 (0.006) PER SIDE.
 4. DIMENSION B DOES NOT INCLUDE INTERLEAD FLASH OR PROTRUSION. INTERLEAD FLASH OR PROTRUSION SHALL NOT EXCEED 0.25 (0.010) PER SIDE.
 5. DIMENSION K DOES NOT INCLUDE DAMBAR PROTRUSION. ALLOWABLE DAMBAR PROTRUSION SHALL BE 0.08 (0.003) TOTAL IN EXCESS OF THE K DIMENSION AT MAXIMUM MATERIAL CONDITION.
 6. TERMINAL NUMBERS ARE SHOWN FOR REFERENCE ONLY.
 7. DIMENSION A AND B ARE TO BE DETERMINED AT DATUM PLANE -W-.

DIM	MILLIMETERS		INCHES	
	MIN	MAX	MIN	MAX
A	4.90	5.10	0.193	0.200
B	4.30	4.50	0.169	0.177
C	---	1.20	---	0.047
D	0.05	0.15	0.002	0.006
F	0.50	0.75	0.020	0.030
G	0.65 BSC		0.026 BSC	
H	0.50	0.60	0.020	0.024
J	0.09	0.20	0.004	0.008
J1	0.09	0.16	0.004	0.006
K	0.19	0.30	0.007	0.012
K1	0.19	0.25	0.007	0.010
L	6.40 BSC		0.252 BSC	
M	0°	8°	0°	8°

ON Semiconductor and are trademarks of Semiconductor Components Industries, LLC dba ON Semiconductor or its subsidiaries in the United States and/or other countries. ON Semiconductor owns the rights to a number of patents, trademarks, copyrights, trade secrets, and other intellectual property. A listing of ON Semiconductor's product/patent coverage may be accessed at www.onsemi.com/site/pdf/Patent-Marking.pdf. ON Semiconductor reserves the right to make changes without further notice to its products herein. ON Semiconductor makes no warranty, representation or guarantee regarding the suitability of its products for any particular purpose, nor does ON Semiconductor assume any liability arising out of the application or use of any product or circuit, and specifically disclaims any and all liability, including without limitation special, consequential or incidental damages. Buyer is responsible for its products and applications using ON Semiconductor products, including compliance with all laws, regulations and safety requirements or standards, regardless of any support or applications information provided by ON Semiconductor. "Typical" parameters which may be provided in ON Semiconductor data sheets and/or specifications can and do vary in different applications and actual performance may vary over time. All operating parameters, including "Typicals" must be validated for each customer application by customer's technical experts. ON Semiconductor does not convey any license under its patent rights nor the rights of others. ON Semiconductor products are not designed, intended, or authorized for use as a critical component in life support systems or any FDA Class 3 medical devices or medical devices with a same or similar classification in a foreign jurisdiction or any devices intended for implantation in the human body. Should Buyer purchase or use ON Semiconductor products for any such unintended or unauthorized application, Buyer shall indemnify and hold ON Semiconductor and its officers, employees, subsidiaries, affiliates, and distributors harmless against all claims, costs, damages, and expenses, and reasonable attorney fees arising out of, directly or indirectly, any claim of personal injury or death associated with such unintended or unauthorized use, even if such claim alleges that ON Semiconductor was negligent regarding the design or manufacture of the part. ON Semiconductor is an Equal Opportunity/Affirmative Action Employer. This literature is subject to all applicable copyright laws and is not for resale in any manner.

PUBLICATION ORDERING INFORMATION



LITERATURE FULFILLMENT:
Literature Distribution Center for ON Semiconductor
19521 E. 32nd Pkwy, Aurora, Colorado 80011 USA
Phone: 303-675-2175 or 800-344-3860 Toll Free USA/Canada
Fax: 303-675-2176 or 800-344-3867 Toll Free USA/Canada
Email: orderlit@onsemi.com

N. American Technical Support: 800-282-9855 Toll Free
USA/Canada
Europe, Middle East and Africa Technical Support:
Phone: 421 33 790 2910
Japan Customer Focus Center
Phone: 81-3-5817-1050

ON Semiconductor Website: www.onsemi.com
Order Literature: <http://www.onsemi.com/orderlit>
For additional information, please contact your local Sales Representative

Looking for pricing, stock, or lifecycle information?

Click below to explore more details on WIN SOURCE:

-  [View LMV393DR2G on WIN SOURCE](#)
-  [ON Semiconductor Information](#)

Optimize Your Supply Chain with WIN SOURCE Solutions

-  Global Sourcing Solution
-  Obsolete Management
-  Cost Control Management
-  Shortage Management
-  Alternative Solution
-  Excess Inventory Management