



**THE DATASHEET OF
QBLP601-IW**



QT-Brightek Chip LED Series

SMD 0603 LED

Part No.: QBLP601 series

Table of Contents:

Introduction	3
Electrical / Optical Characteristic (Ta=25 °C)	4
Absolute Maximum Rating	4
CIE Chromaticity Diagram.....	7
Solder Profile & Footprint.....	10
Packing	11
Labeling	12
Ordering Information	12
Revision History	13
Disclaimer	13

Introduction

Feature:

- Water clear lens
- Yellow diffused lens for IW
- Package in tape and reel
- Ultra bright 0603 LED package
- InGaN technology for IB/IG/IW
- AlInGaP technology for R/S/AG/Y/O

Description:

These ultra bright 0603 LEDs have a height profile of 0.60mm. Combination of high brightness output and small footprint, these LEDs are ideal for keypad backlighting and status indication.

Application:

- Status indication
- Back lighting application

Certification & Compliance:

- TS16949
- ISO9001
- RoHS Compliant



Dimension:

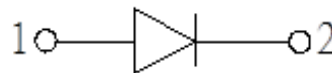
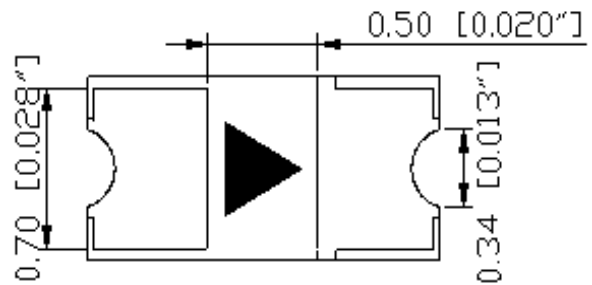
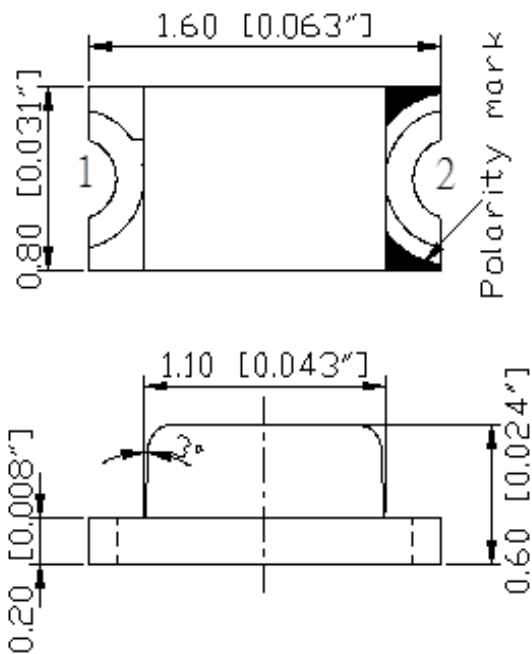

Units: mm / tolerance = +/-0.1mm

Electrical / Optical Characteristic (Ta=25 °C)

Product	Color	I _F (mA)	V _F (V)		λ _D (nm)			I _V (mcd)	
			Typ.	Max.	Min.	Typ.	Max.	Min.	Typ.
QBLP601-IB	Blue	20	3.2	3.7	465	470	475	50	90
QBLP601-IG	True Green	20	3.2	3.7	520	525	530	250	450
QBLP601-IW	White	20	3.2	3.7	-	X=0.28 Y=0.26	-	200	330
QBLP601-R	Red	20	2.0	2.5	620	625	630	80	100
QBLP601-S	Deep Red	20	2.0	2.5	630	640	650	25	45
QBLP601-AG	Yellow Green	20	2.0	2.5	565	570	576	32	45
QBLP601-Y	Yellow	20	2.0	2.5	585	590	595	80	150
QBLP601-O	Orange	20	2.0	2.5	600	605	610	80	165

Absolute Maximum Rating

Material	P _d (mW)	I _F (mA)	I _{FP} (mA)*	V _R (V)	T _{OP} (°C)	T _{ST} (°C)	T _{SOL} (°C)**
InGaN (IB/IG/IW)	111	30	125	5	-40 ~ +80	-40 ~ +100	260
AllnGaP (R/S/AG/Y/O)	75	30	125	5	-40 ~ +80	-40 ~ +100	260

*Duty 1/8 @ 1KHz

**IR Reflow for no more than 10 sec @ 260 °C

Forward Voltage V_F @ $I_F=20mA$

Bin	Min.	Max.	Unit
b	1.6	1.9	V
c	1.9	2.2	
d	2.2	2.5	
e	2.5	2.8	
f	2.8	3.1	
g	3.1	3.4	
h	3.4	3.7	

Luminous Intensity I_V @ $I_F=20mA$

Bin	Min.	Max.	Unit
D	25	32	mcd
E	32	40	
F	40	50	
G	50	63	
H	63	80	
I	80	100	
J	100	125	
K	125	160	
L	160	200	
M	200	250	
N	250	320	
O	320	400	
P	400	500	
Q	500	630	
R	630	800	

Dominant Wavelength λ_D for Blue @ $I_F=20mA$

Bin	Min.	Max.	Unit
G	465	467.5	nm
H	467.5	470	
I	470	472.5	
J	472.5	475	

Dominant Wavelength λ_D for True Green @ $I_F=20mA$

Bin	Min.	Max.	Unit
U	520	522.5	nm
V	522.5	525	
W	525	527.5	
X	527.5	530	

Dominant Wavelength λ_D for Red @ $I_F=20mA$

Bin	Min.	Max.	Unit
t	620	625	nm
u	625	630	

Dominant Wavelength λ_D for Deep Red @ $I_F=20mA$

Bin	Min.	Max.	Unit
v	630	635	nm
w	635	650	

Dominant Wavelength λ_D for Yellow Green @ $I_F=20mA$

Bin	Min.	Max.	Unit
h	565	568	nm
i	568	572	
j	572	576	

Dominant Wavelength λ_D for Yellow @ $I_F=20mA$

Bin	Min.	Max.	Unit
m	585	590	nm
n	590	595	

Dominant Wavelength λ_D for Orange @ $I_F=20mA$

Bin	Min.	Max.	Unit
p	600	605	nm
q	605	610	

CIE Chromaticity Diagram

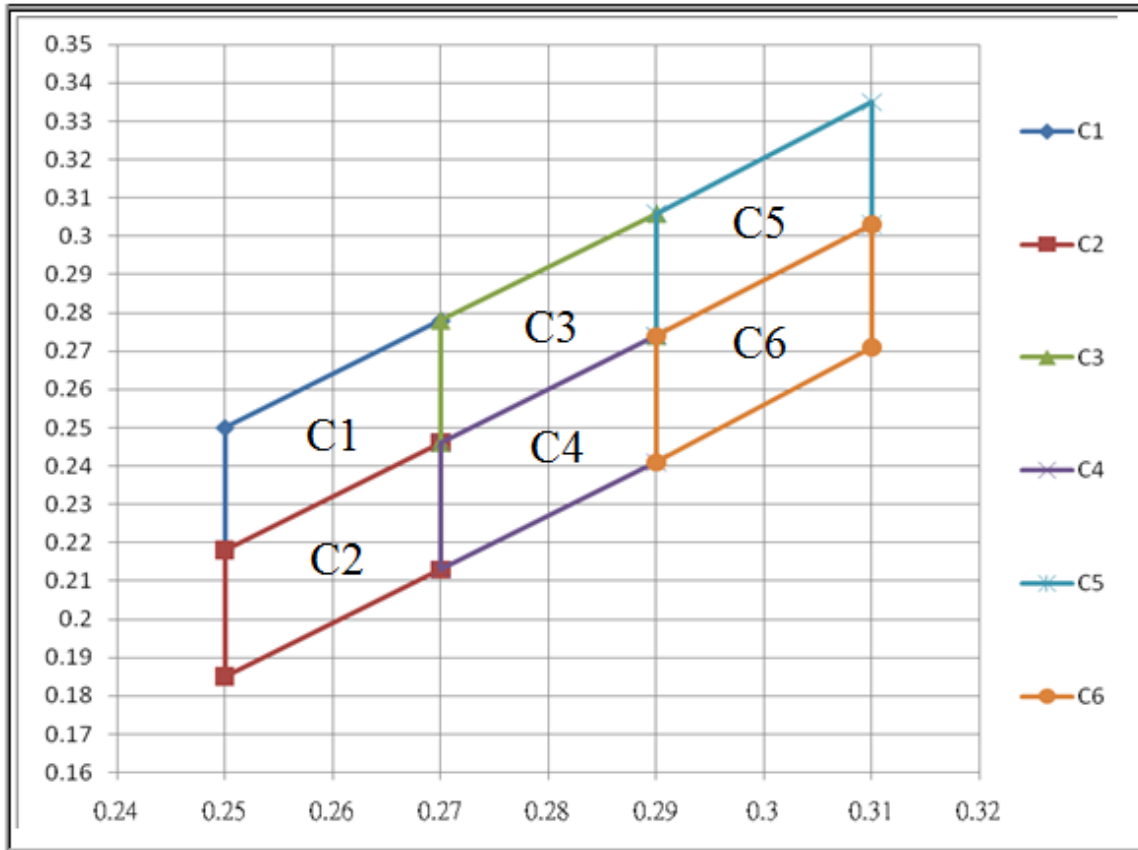

Chromaticity coordinates Ranks combination (IF=20mA)					
Rank		Chromaticity coordinates			
C1	X	0.250	0.250	0.270	0.270
	Y	0.218	0.250	0.278	0.246
C2	X	0.250	0.250	0.270	0.270
	Y	0.185	0.218	0.246	0.213
C3	X	0.270	0.270	0.290	0.290
	Y	0.246	0.278	0.306	0.274
C4	X	0.270	0.270	0.290	0.290
	Y	0.213	0.246	0.274	0.241
C5	X	0.290	0.290	0.310	0.310
	Y	0.274	0.306	0.335	0.303
C6	X	0.290	0.290	0.310	0.310
	Y	0.241	0.274	0.303	0.271

Characteristic Curves

AllnGaP (R/S/AG/Y/O)

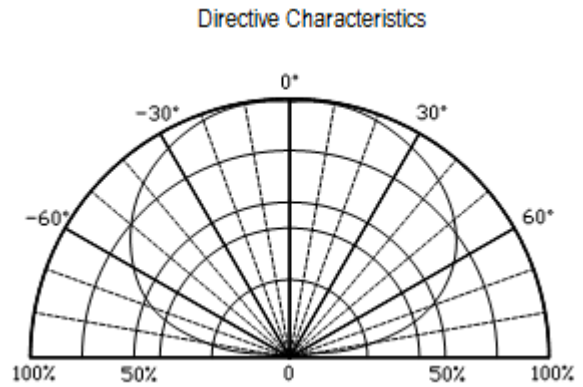
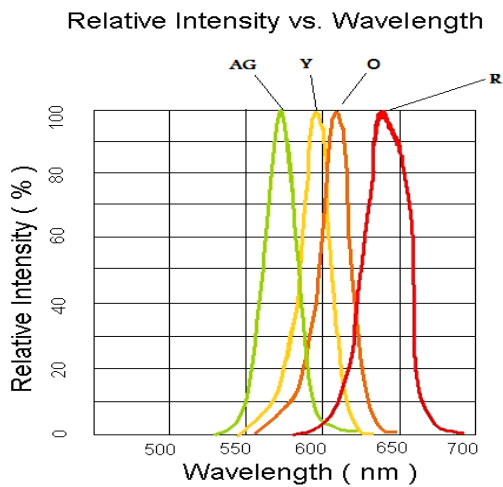
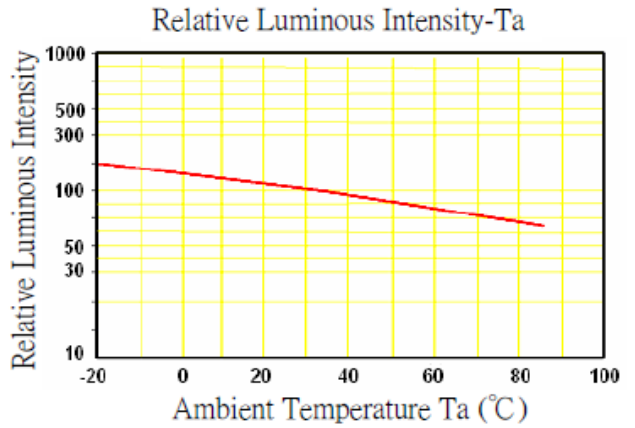
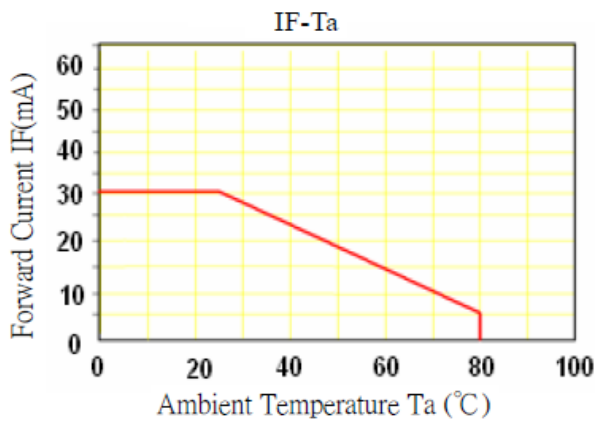
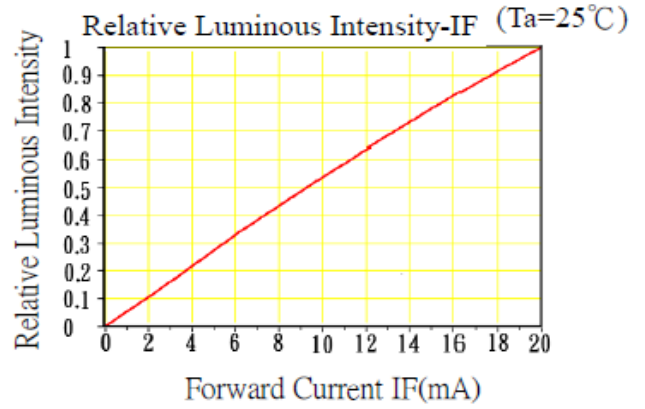
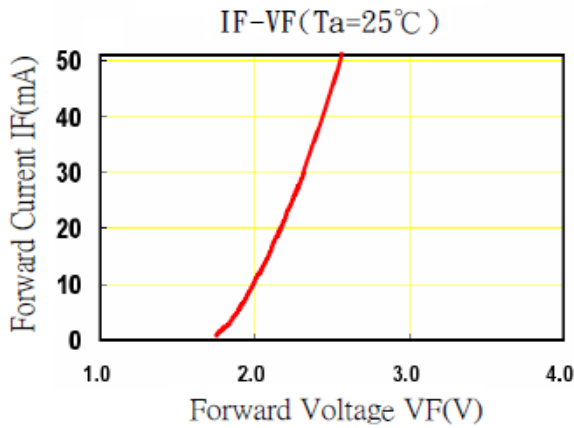

InGaN (IB/IG/IW)

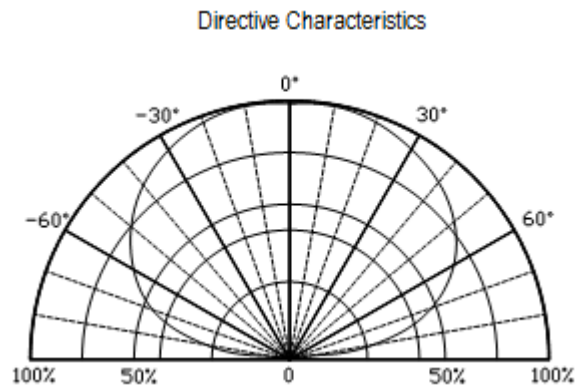
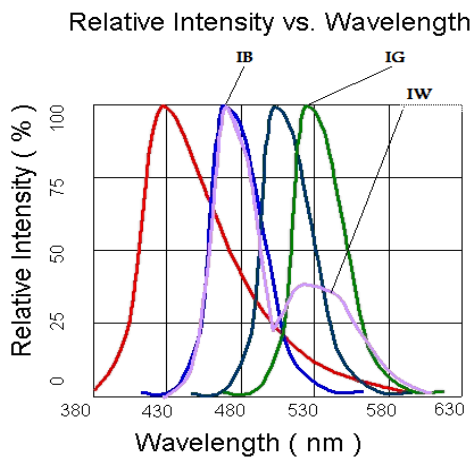
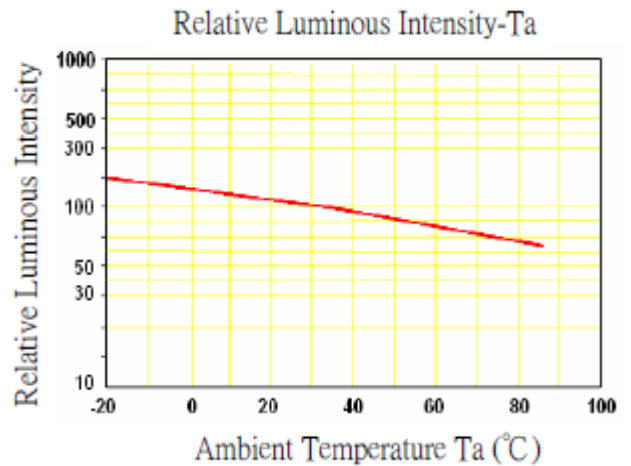
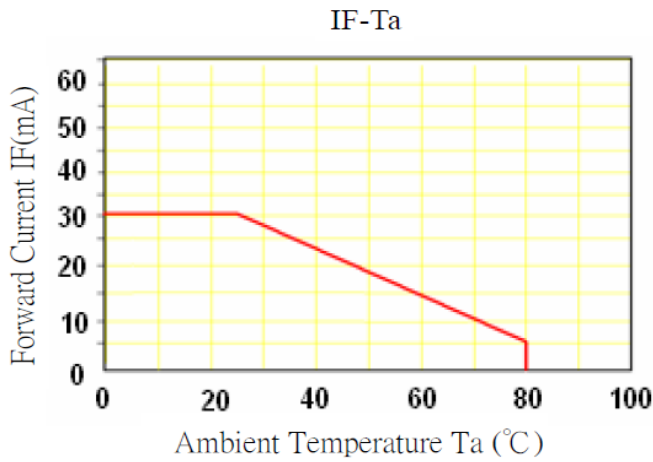
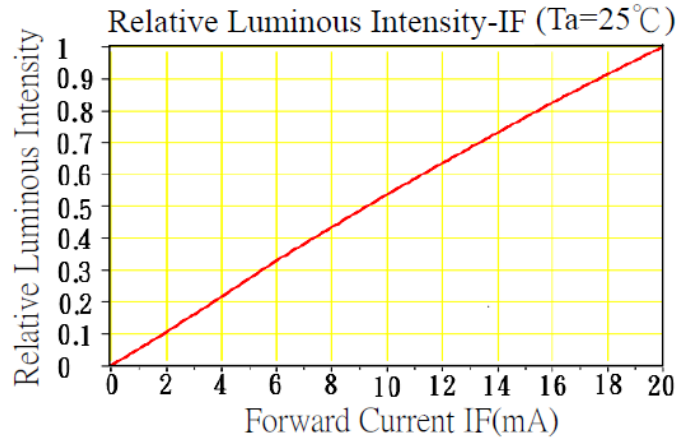
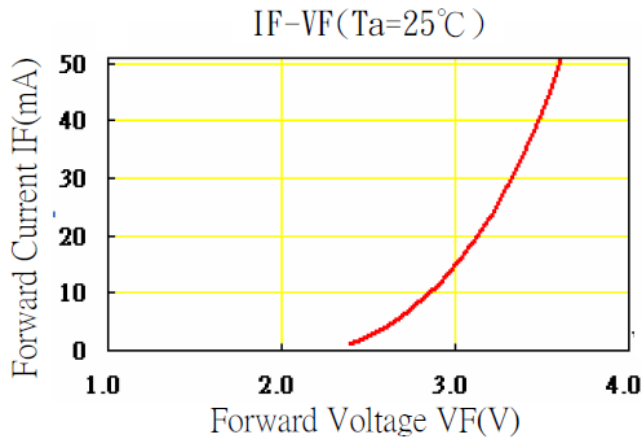

Solder Profile & Footprint

- Recommended tin solder specifications: melting temperature in the range of 178~192 °C
- The recommended reflow soldering profile is as follows (temperatures indicated are as measured on the surface of the LED resin):

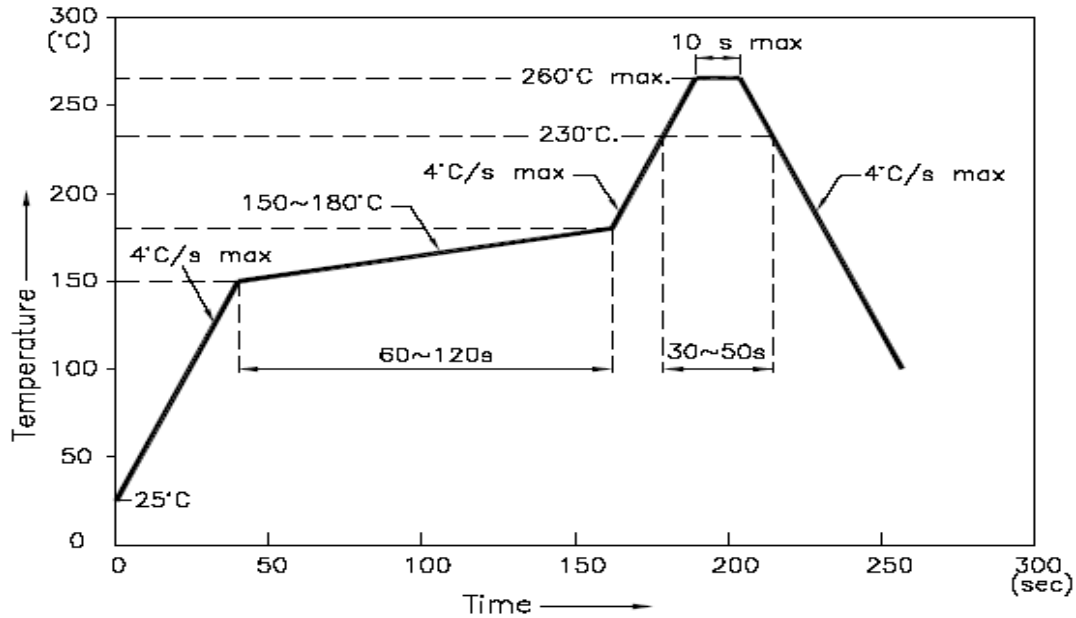

Recommended Pad Layout

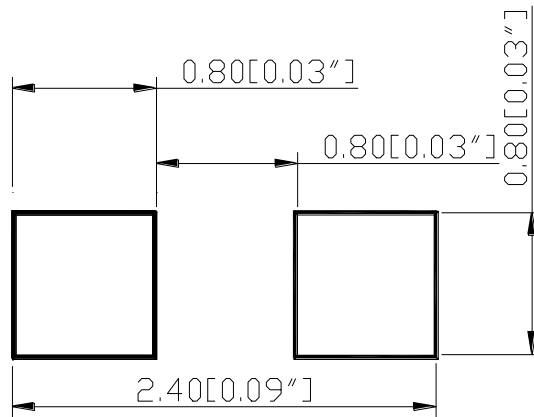

Units: mm

Tolerance: ± 0.1mm

Packing

Reel Dimension:

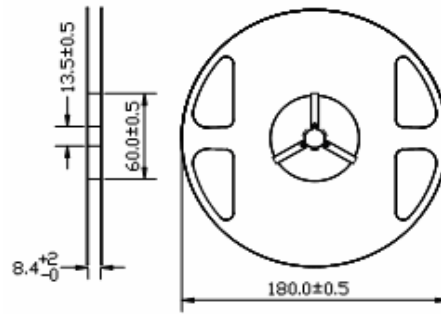

Unit: mm

Tape Dimension:

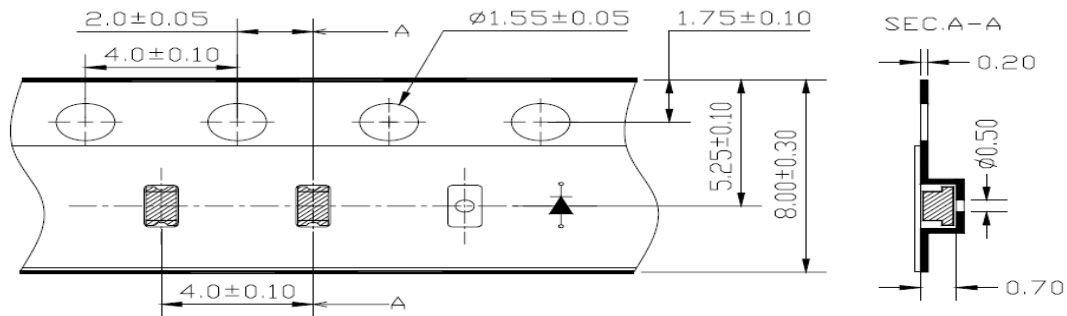

Unit: mm

Arrangement of Tape:

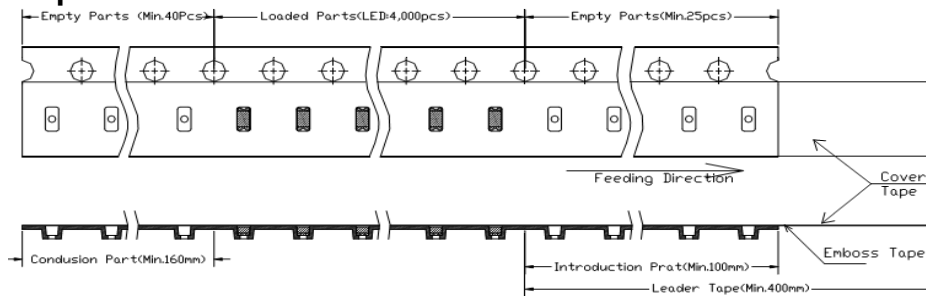

Packaging Specifications:

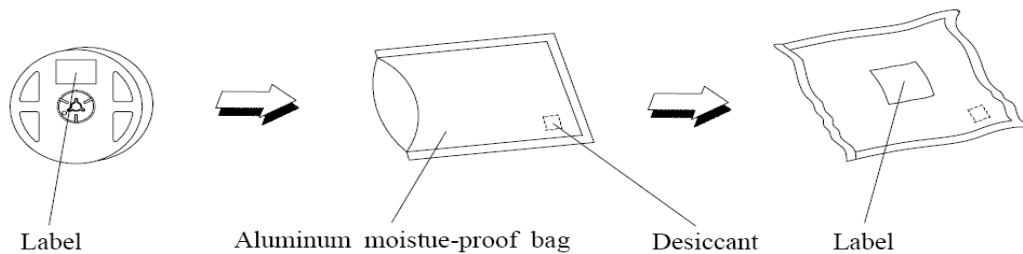

Labeling



Part No: _____

Customer P/N: _____

Item: _____

Q'ty: _____

Vf: _____

Iv: _____

WI: _____

Date: _____

Made in China

Ordering Information

Part #	Orderable Part #	Spec Range	Quantity per reel
QBLP601-IB	QBLP601-IB	Iv=90mcd Typ. @ I _F =20mA / Color=465nm-475nm	4,000 units
QBLP601-IG	QBLP601-IG	Iv=450mcd Typ. @ I _F =20mA / Color=520nm-530nm	4,000 units
QBLP601-IW	QBLP601-IW	Iv=330mcd Typ. @ I _F =20mA / CCT: (X=0.28, Y=0.26) typ.	4,000 units
QBLP601-R	QBLP601-R	Iv=100mcd Typ. @ I _F =20mA / Color=620nm-630nm	4,000 units
QBLP601-S	QBLP601-S	Iv=45mcd Typ. @ I _F =20mA / Color=630nm-635nm	4,000 units
QBLP601-AG	QBLP601-AG	Iv=45mcd Typ. @ I _F =20mA / Color=565nm-576nm	4,000 units
QBLP601-Y	QBLP601-Y	Iv=150mcd Typ. @ I _F =20mA / Color=585nm-595nm	4,000 units
QBLP601-O	QBLP601-O	Iv=165mcd Typ. @ I _F =20mA / Color=600nm-610nm	4,000 units

Revision History

Description:	Revision #	Revision Date
New Release of QBLP601 series	V1.0	9/20/2010
Update opto specifications	V2.0	02/03/2011
Added QBLP601-O	V2.1	06/16/2011
Added Bin Code/ update Electrical/ Optical Characteristic	V2.2	10/04/2011
Update Format	V2.3	03/23/2012
Update orange brightness	V2.4	06/07/2012
Update white (x,y) coordinates	V2.5	05/30/2013
Update outline dimensions and spec	V3.0	11/04/2013
Information update	V3.1	02/13/2014
Add deep red (QBLP601-S)	V3.2	11/13/2014

Disclaimer

QT-BRIGHTTEK reserves the right to make changes without further notice to any products herein to improve reliability, function or design. QT-BRIGHTTEK does not assume any liability arising out of the application or use of any product or circuit described herein; neither does it convey any license under its patent rights, nor the rights of others.

Life Support Policy

QT-BRIGHTTEK's products are not authorized for use as critical components in life support devices or systems without the express written approval of QT-BRIGHTTEK. As used herein:

1. Life support devices or systems are devices or systems which, (a) are intended for surgical implant into the body, or (b) support or sustain life, and (c) whose failure to perform when properly used in accordance with instructions for use provided in the labeling, can be reasonably expected to result in a significant injury of the user.
2. A critical component in any component of a life support device or system whose failure to perform can be reasonably expected to cause the failure of the life support device or system, or to affect its safety or effectiveness.

Looking for pricing, stock, or lifecycle information?

Click below to explore more details on WIN SOURCE:

 [View QBLP601-IW on WIN SOURCE](#)

 [QT Brightek \(QTB\) Information](#)

Optimize Your Supply Chain with WIN SOURCE Solutions

-  Global Sourcing Solution
-  Obsolete Management
-  Cost Control Management
-  Shortage Management
-  Alternative Solution
-  Excess Inventory Management