



**THE DATASHEET OF
IP3319CX6,135**



Important notice

Dear Customer,

On 7 February 2017 the former NXP Standard Product business became a new company with the tradename **Nexperia**. Nexperia is an industry leading supplier of Discrete, Logic and PowerMOS semiconductors with its focus on the automotive, industrial, computing, consumer and wearable application markets

In data sheets and application notes which still contain NXP or Philips Semiconductors references, use the references to Nexperia, as shown below.

Instead of <http://www.nxp.com>, <http://www.philips.com/> or <http://www.semiconductors.philips.com/>, use <http://www.nexperia.com>

Instead of sales.addresses@www.nxp.com or sales.addresses@www.semiconductors.philips.com, use salesaddresses@nexperia.com (email)

Replace the copyright notice at the bottom of each page or elsewhere in the document, depending on the version, as shown below:

- © NXP N.V. (year). All rights reserved or © Koninklijke Philips Electronics N.V. (year). All rights reserved

Should be replaced with:

- © **Nexperia B.V. (year). All rights reserved.**

If you have any questions related to the data sheet, please contact our nearest sales office via e-mail or telephone (details via salesaddresses@nexperia.com). Thank you for your cooperation and understanding,

Kind regards,

Team Nexperia

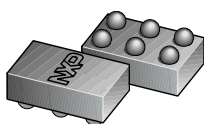

IP3319CX6

Single-channel common-mode filter with integrated ESD protection network

Rev. 2 — 29 May 2013

Product data sheet

1. Product profile

1.1 General description

2-lines (one differential channel) common-mode filter with integrated ESD protection up to 15 kV contact discharge, exceeding IEC 61000-4-2, level 4. The device can eliminate efficiently common-mode noise from USB 2.0 and other high-speed interfaces with differential lines. IP3319CX6 attenuates significantly common-mode noise above 800 MHz while differential-mode signal extends out to more than 1 GHz before reaching the -3 dB point.

IP3319CX6 is designed to protect sensitive I/Os, such as USB 2.0, Ethernet, Digital Video Interface (DVI) and Low-Voltage Differential Signaling (LVDS) interfaces from destruction by ElectroStatic Discharge (ESD).

IP3319CX6 is a combination of an integrated copper-coils common-mode filter and a monolithic silicon technology-based ESD protection. It integrates two ultra-low capacitance rail-to-rail diodes plus a separated protection diode in a 0.4 mm pitch Wafer-Level Chip-Size Package (WLCSP). Due to the rail-to-rail concept, the protection is working independently from availability of a supply voltage

1.2 Features and benefits

- 2-lines (one differential mode) common-mode filter
- ESD protection for the USB ID line
- Extremely low clamping voltage
- ESD protection up to ± 15 kV on external contact pins
- Ultra low ESD diode capacitance
- WLCSP6 with 0.4 mm pitch

1.3 Applications

- USB 2.0 High-speed lines
- LVDS interfaces
- DVI

1.4 Quick reference data

Table 1. Quick reference data

Symbol	Parameter	Conditions	Min	Typ	Max	Unit
$R_{s(ch)}$	channel series resistance	single line; input to output	-	6	-	Ω
C_d	diode capacitance	$V_1 = 0$ V; $f = 1$ MHz; pins A2, B2 to GND	[1] -	1.5	-	pF

[1] This parameter is guaranteed by design.



2. Pinning information

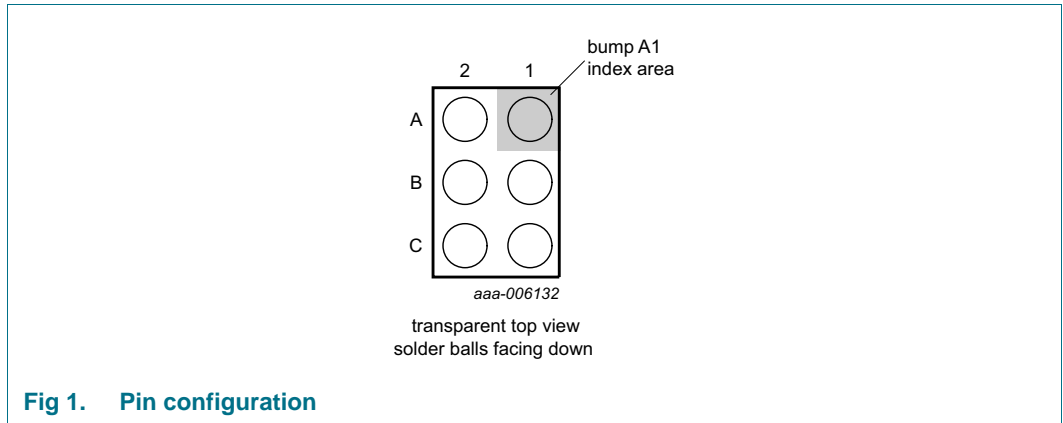

Table 2. Pinning

Pin	Symbol [1]	Description [1]
A1	D+_OUT	USB data D+ (host side)
A2	D+_IN	USB data D+ (connector side)
B1	D-_OUT	USB data D- (host side)
B2	D-_IN	USB data D- (connector side)
C1	GND	ground
C2	ID	USB identification

[1] D+ and D- are interchangeable.

3. Ordering information

Table 3. Ordering information

Type number	Package		Version
	Name	Description	
IP3319CX6	WLCSP6	wafer level chip-size package; 6 bumps (2 × 3) [1]	IP3319CX6

[1] Size: 1.34 mm × 0.95 mm × 0.57 mm

4. Marking

IP3319CX6 is laser-marked with the following information (see [Figure 2](#)):

- A marker indicating the pin A1 position.
- Two lines of characters or numbers:
 - The first line (placeholder <marking code>) indicates the marking code. Mapping of product type number to marking code is given in [Table 4](#).
 - The second line (placeholder <lot ID>) indicates the production lot. This information enables tracking a device down to a particular production date.

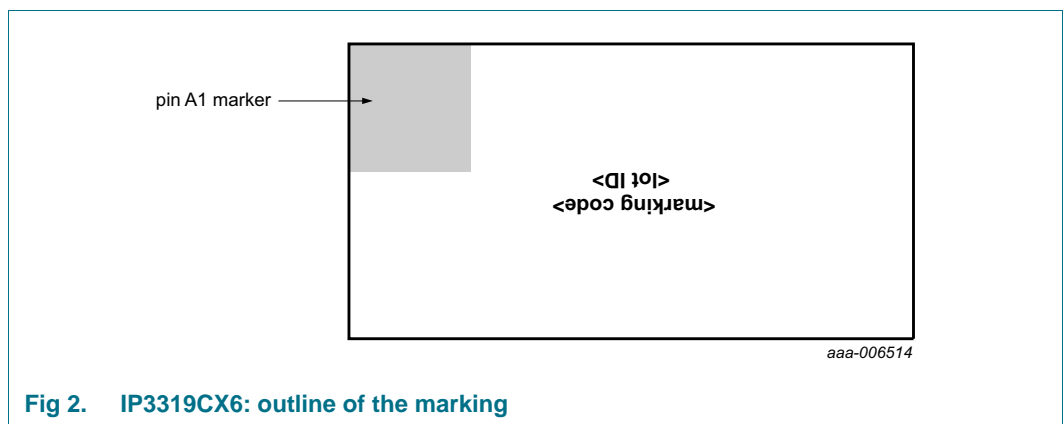

Fig 2. IP3319CX6: outline of the marking

Table 4. Marking codes

Type number	Marking code
IP3319CX6	319

5. Functional diagram

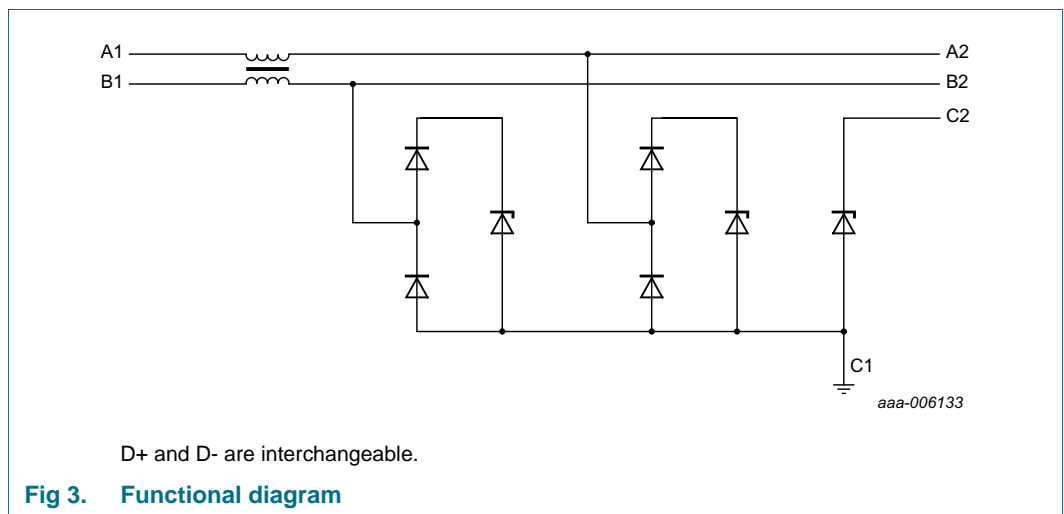

Fig 3. Functional diagram

6. Limiting values

Table 5. Limiting values

In accordance with the Absolute Maximum Rating System (IEC 60134).

Symbol	Parameter	Conditions	Min	Max	Unit		
V_I	input voltage		0.5	5.5	V		
V_{ESD}	electrostatic discharge voltage	IEC 61000-4-2, level 4; pins A2, B2, C2 to GND (C1)	contact discharge	-15	+15	kV	
			air discharge	-15	+15	kV	
		IEC 61000-4-2, level 4; pins A1, B1 to GND (C1)	contact discharge	-2	+2	kV	
			air discharge	-2	+2	kV	
		T_{stg}	storage temperature		-55	+125	°C
		T_{amb}	ambient temperature		-40	+85	°C

7. Characteristics

7.1 Electrical characteristics

Table 6. Electrical characteristics

$T_{amb} = 25\text{ °C}$ unless otherwise specified.

Symbol	Parameter	Conditions	Min	Typ	Max	Unit
$R_{s(ch)}$	channel series resistance	single line; input to output	-	6	-	Ω
C_d	diode capacitance	$V_I = 0\text{ V}$; $f = 1\text{ MHz}$; pins A2, B2 to GND	[1] -	1.5	-	pF
		pin C2 to GND	[1] -	1.7	-	pF
I_{RM}	reverse leakage current	pins A2, B2, C2 to GND; $V_I = 3\text{ V}$	-	0.01	1	μA
V_{BR}	breakdown voltage	pins A2, B2, C2 to GND; $I_R = 10\text{ mA}$	6	-	10	V
V_F	forward voltage	$I_F = 10\text{ mA}$	-	0.7	-	V
R_{dyn}	dynamic resistance	TLP	[2]			
		positive transient	-	0.25	-	Ω
		negative transient	-	0.20	-	Ω
		surge	[3]			
		positive transient	-	0.20	-	Ω
		negative transient	-	0.14	-	Ω
V_{CL}	clamping voltage	$I_{CL} = 6\text{ A}$	[3] -	4	-	V
		$I_{CL} = -6\text{ A}$	[3] -	-2.5	-	V

[1] This parameter is guaranteed by design.

[2] 100 ns Transmission Line Pulse (TLP); 50 Ω ; pulser at 80 ns.

[3] According to IEC 61000-4-5 (8/20 μs).

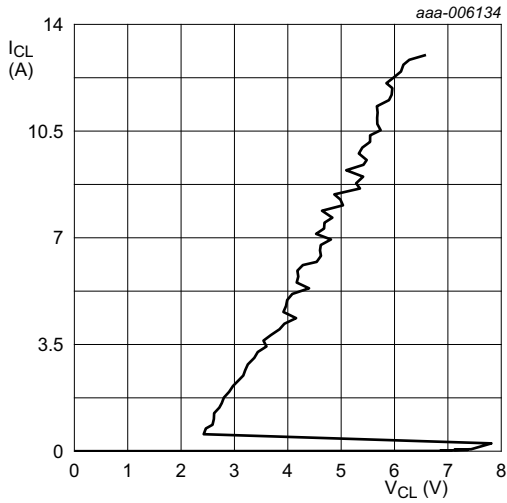

Pin A2; $t_p = 100$ ns; Transmission Line Pulse (TLP)

Fig 4. Dynamic resistance with positive clamping

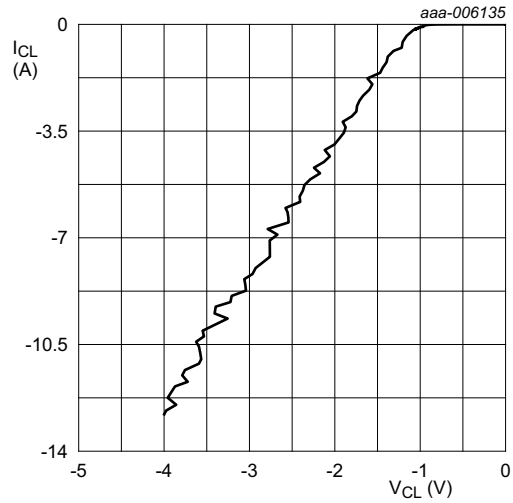

Pin A2; $t_p = 100$ ns; Transmission Line Pulse (TLP)

Fig 5. Dynamic resistance with negative clamping

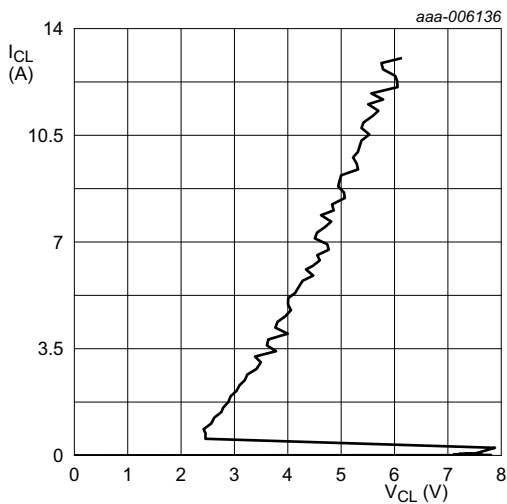

Pin C2; $t_p = 100$ ns; Transmission Line Pulse (TLP)

Fig 6. Dynamic resistance with positive clamping

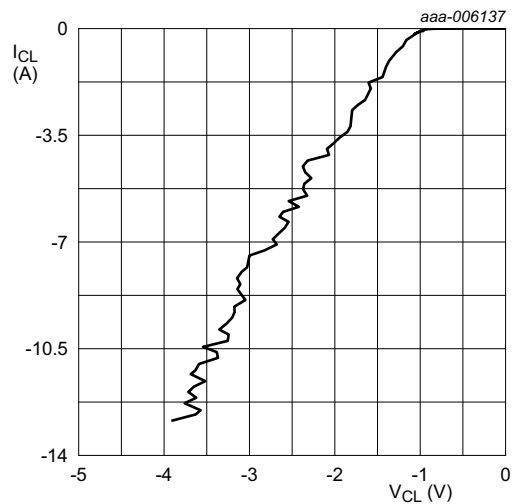

Pin C2; $t_p = 100$ ns; Transmission Line Pulse (TLP)

Fig 7. Dynamic resistance with negative clamping

The device uses an advanced clamping structure showing a negative dynamic resistance. This snap-back behavior strongly reduces the clamping voltage to the system behind the ESD protection during an ESD event. Do not connect unlimited DC current sources to the data lines to avoid keeping the ESD protection device in snap-back state after exceeding breakdown voltage (due to an ESD pulse for instance).

7.2 Frequency characteristics

Table 7. Frequency characteristics

Symbol	Parameter	Conditions	Min	Typ	Max	Unit
Common mode						
α_{il}	insertion loss	S21cc; $R_{gen} = 50 \Omega$; $R_L = 50 \Omega$				
		$700 \text{ MHz} \leq f \leq 1.8 \text{ GHz}$	-	-	-13	dB
		$f > 1.8 \text{ GHz}$	-	-	-11	dB
Differential mode						
α_{il}	insertion loss	S21dd; $R_{gen} = 50 \Omega$; $R_L = 50 \Omega$				
		$f = 500 \text{ MHz}$	-3	-	-	dB
		$f = 1 \text{ GHz}$	-5	-	-	dB

Figure 8 shows the common mode and differential mode attenuation measured in a 50 Ω NetWork Analyzer (NWA) system.

The 3 dB point for the differential-mode signal is above 1 GHz. The common-mode attenuation reaches a typical value of -25 dB in the GSM band.

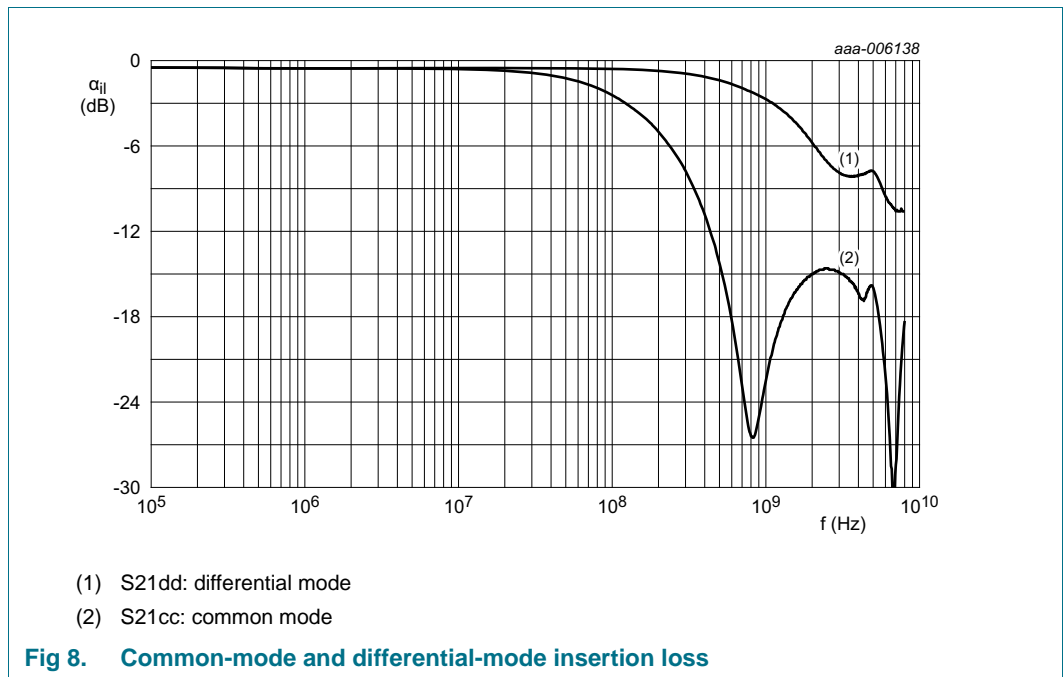

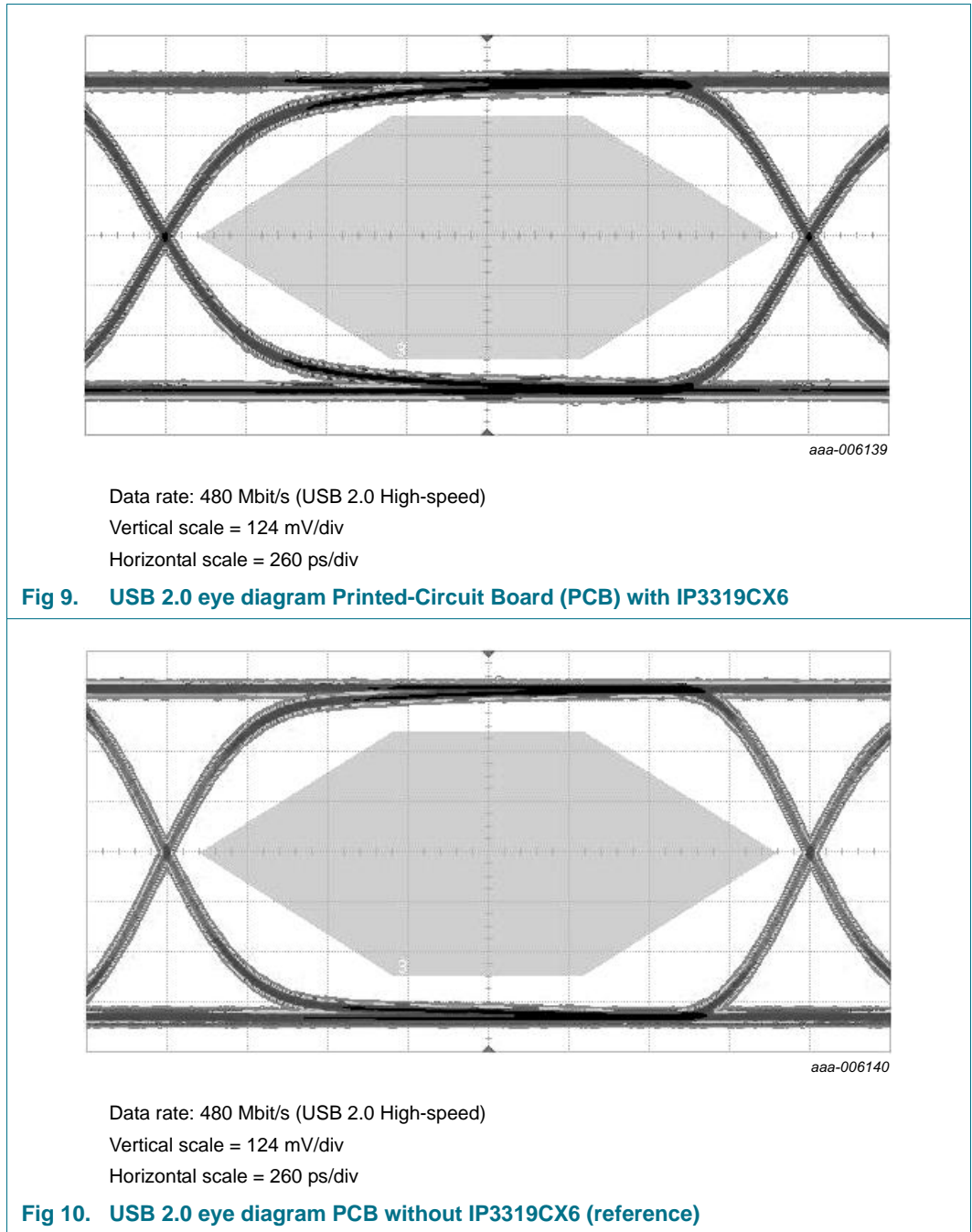

9. Packing information

Table 9. Packing methods

The indicated -xxx are the last three digits of the 12NC ordering code.^[1]

Type number	Package	Description	Packing quantity
			4 500
IP3319CX6	WLCSP6	4 mm pitch, 8 mm tape and reel	-135

[1] For further information and the availability of packing methods, see [Section 14](#).

10. Soldering

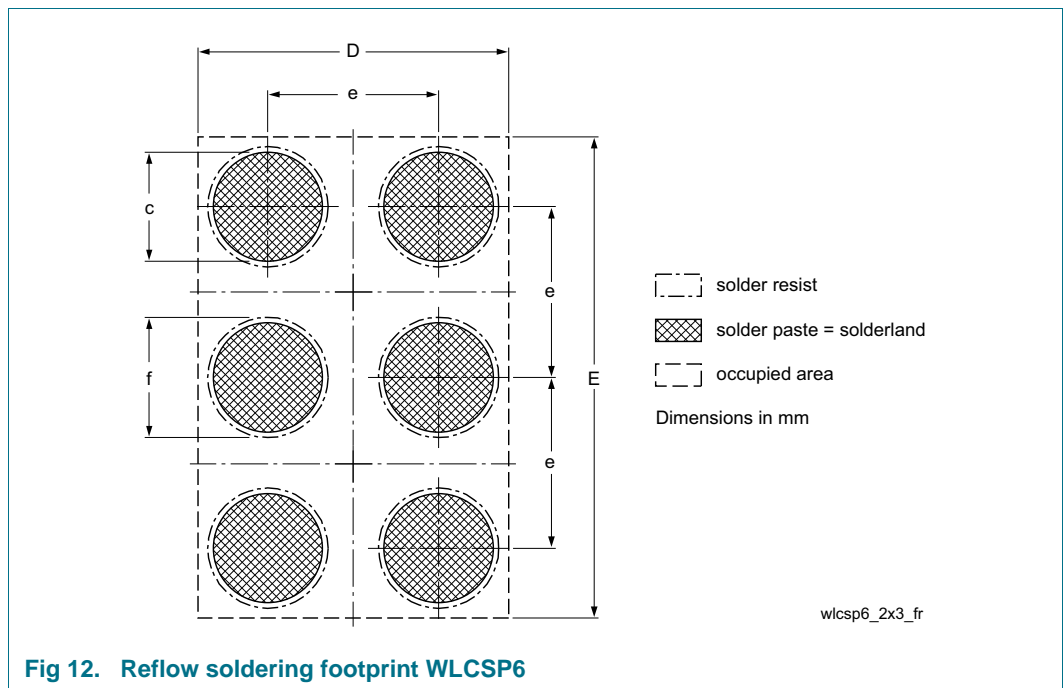

Fig 12. Reflow soldering footprint WLCSP6

Table 10. Reflow soldering dimensions of WLCSP6

Symbol	Min	Typ	Max	Unit
c	-	0.25	-	mm
D	0.91	0.96	1.01	mm
E	1.31	1.36	1.41	mm
e	-	0.40	-	mm
f	-	0.325	-	mm

11. Design and assembly recommendations

11.1 PCB design guidelines

For optimum performance, use a Non-Solder Mask Defined (NSMD), also known as a copper-defined design, incorporating laser-drilled micro-vias connecting the ground pads to a buried ground-plane layer. This results in the lowest possible ground inductance and provides the best high frequency and ESD performance. Refer to [Table 11](#) for the recommended Printed-Circuit Board (PCB) design parameters.

Table 11. Recommended PCB design parameters

Parameter	Value or specification
PCB pad diameter	250 μm
Micro-via diameter	100 μm (0.004 inch)
Solder mask aperture diameter	325 μm
Copper thickness	20 μm to 40 μm
Copper finish	AuNi
PCB material	FR4

11.2 PCB assembly guidelines for Pb-free soldering

Table 12. Assembly recommendations

Parameter	Value or specification
Solder screen aperture diameter	290 μm
Solder screen thickness	100 μm (0.004 inch)
Solder paste: Pb-free	SnAg (3 % to 4 %) Cu (0.5 % to 0.9 %)
Solder to flux ratio	50 : 50
Solder reflow profile	see Figure 13

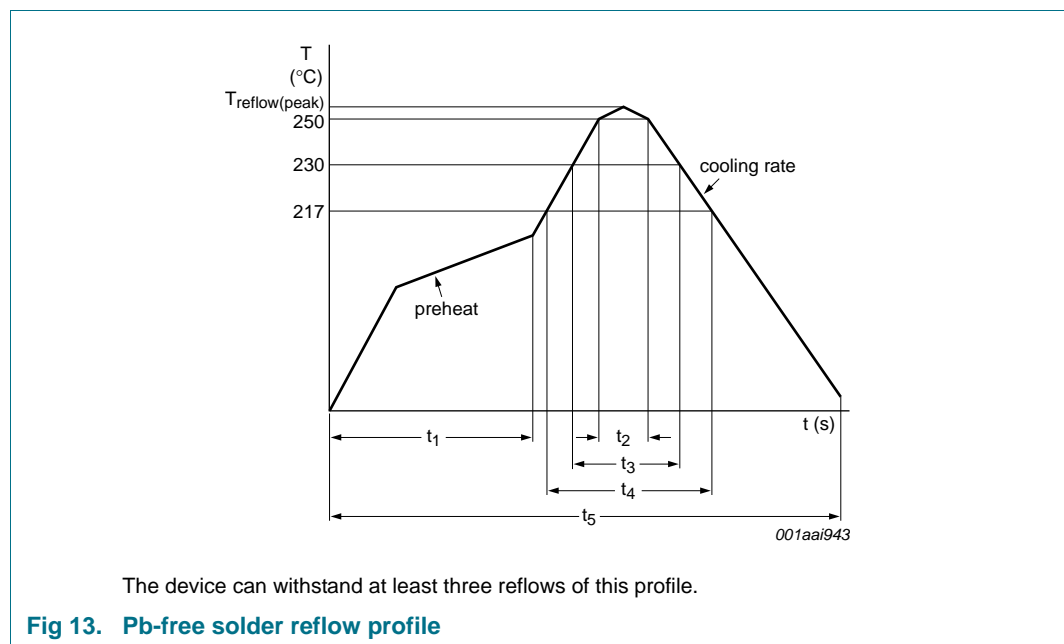

Table 13. Characteristics

Symbol	Parameter	Conditions	Min	Typ	Max	Unit
$T_{\text{reflow(peak)}}$	peak reflow temperature		230	-	260	°C
t_1	time 1	soak time	60	-	180	s
t_2	time 2	time during $T \geq 250$ °C	-	-	30	s
t_3	time 3	time during $T \geq 230$ °C	10	-	50	s
t_4	time 4	time during $T > 217$ °C	30	-	150	s
t_5	time 5		-	-	540	s
dT/dt	rate of change of temperature	cooling rate	-	-	-6	°C/s
		pre-heat	2.5	-	4.0	°C/s

12. Revision history

Table 14. Revision history

Document ID	Release date	Data sheet status	Change notice	Supersedes
IP3319CX6 v.2	20130529	Product data sheet	-	IP3319CX6 v.1
Modifications:		<ul style="list-style-type: none">• Section 1.1 “General description”: corrected• Table 5: V_I and V_{ESD} updated• Table 6: $R_{S(ch)}$, C_d and V_{BR} updated• Section 13 “Legal information”: updated		
IP3319CX6 v.1	20130130	Product data sheet	-	-

13. Legal information

13.1 Data sheet status

Document status ^{[1][2]}	Product status ^[3]	Definition
Objective [short] data sheet	Development	This document contains data from the objective specification for product development.
Preliminary [short] data sheet	Qualification	This document contains data from the preliminary specification.
Product [short] data sheet	Production	This document contains the product specification.

[1] Please consult the most recently issued document before initiating or completing a design.

[2] The term 'short data sheet' is explained in section "Definitions".

[3] The product status of device(s) described in this document may have changed since this document was published and may differ in case of multiple devices. The latest product status information is available on the Internet at URL <http://www.nxp.com>.

13.2 Definitions

Draft — The document is a draft version only. The content is still under internal review and subject to formal approval, which may result in modifications or additions. NXP Semiconductors does not give any representations or warranties as to the accuracy or completeness of information included herein and shall have no liability for the consequences of use of such information.

Short data sheet — A short data sheet is an extract from a full data sheet with the same product type number(s) and title. A short data sheet is intended for quick reference only and should not be relied upon to contain detailed and full information. For detailed and full information see the relevant full data sheet, which is available on request via the local NXP Semiconductors sales office. In case of any inconsistency or conflict with the short data sheet, the full data sheet shall prevail.

Product specification — The information and data provided in a Product data sheet shall define the specification of the product as agreed between NXP Semiconductors and its customer, unless NXP Semiconductors and customer have explicitly agreed otherwise in writing. In no event however, shall an agreement be valid in which the NXP Semiconductors product is deemed to offer functions and qualities beyond those described in the Product data sheet.

13.3 Disclaimers

Limited warranty and liability — Information in this document is believed to be accurate and reliable. However, NXP Semiconductors does not give any representations or warranties, expressed or implied, as to the accuracy or completeness of such information and shall have no liability for the consequences of use of such information. NXP Semiconductors takes no responsibility for the content in this document if provided by an information source outside of NXP Semiconductors.

In no event shall NXP Semiconductors be liable for any indirect, incidental, punitive, special or consequential damages (including - without limitation - lost profits, lost savings, business interruption, costs related to the removal or replacement of any products or rework charges) whether or not such damages are based on tort (including negligence), warranty, breach of contract or any other legal theory.

Notwithstanding any damages that customer might incur for any reason whatsoever, NXP Semiconductors' aggregate and cumulative liability towards customer for the products described herein shall be limited in accordance with the *Terms and conditions of commercial sale* of NXP Semiconductors.

Right to make changes — NXP Semiconductors reserves the right to make changes to information published in this document, including without limitation specifications and product descriptions, at any time and without notice. This document supersedes and replaces all information supplied prior to the publication hereof.

Suitability for use — NXP Semiconductors products are not designed, authorized or warranted to be suitable for use in life support, life-critical or safety-critical systems or equipment, nor in applications where failure or malfunction of an NXP Semiconductors product can reasonably be expected to result in personal injury, death or severe property or environmental damage. NXP Semiconductors and its suppliers accept no liability for inclusion and/or use of NXP Semiconductors products in such equipment or applications and therefore such inclusion and/or use is at the customer's own risk.

Applications — Applications that are described herein for any of these products are for illustrative purposes only. NXP Semiconductors makes no representation or warranty that such applications will be suitable for the specified use without further testing or modification.

Customers are responsible for the design and operation of their applications and products using NXP Semiconductors products, and NXP Semiconductors accepts no liability for any assistance with applications or customer product design. It is customer's sole responsibility to determine whether the NXP Semiconductors product is suitable and fit for the customer's applications and products planned, as well as for the planned application and use of customer's third party customer(s). Customers should provide appropriate design and operating safeguards to minimize the risks associated with their applications and products.

NXP Semiconductors does not accept any liability related to any default, damage, costs or problem which is based on any weakness or default in the customer's applications or products, or the application or use by customer's third party customer(s). Customer is responsible for doing all necessary testing for the customer's applications and products using NXP Semiconductors products in order to avoid a default of the applications and the products or of the application or use by customer's third party customer(s). NXP does not accept any liability in this respect.

Limiting values — Stress above one or more limiting values (as defined in the Absolute Maximum Ratings System of IEC 60134) will cause permanent damage to the device. Limiting values are stress ratings only and (proper) operation of the device at these or any other conditions above those given in the Recommended operating conditions section (if present) or the Characteristics sections of this document is not warranted. Constant or repeated exposure to limiting values will permanently and irreversibly affect the quality and reliability of the device.

Terms and conditions of commercial sale — NXP Semiconductors products are sold subject to the general terms and conditions of commercial sale, as published at <http://www.nxp.com/profile/terms>, unless otherwise agreed in a valid written individual agreement. In case an individual agreement is concluded only the terms and conditions of the respective agreement shall apply. NXP Semiconductors hereby expressly objects to applying the customer's general terms and conditions with regard to the purchase of NXP Semiconductors products by customer.

No offer to sell or license — Nothing in this document may be interpreted or construed as an offer to sell products that is open for acceptance or the grant, conveyance or implication of any license under any copyrights, patents or other industrial or intellectual property rights.

Export control — This document as well as the item(s) described herein may be subject to export control regulations. Export might require a prior authorization from competent authorities.

Quick reference data — The Quick reference data is an extract of the product data given in the Limiting values and Characteristics sections of this document, and as such is not complete, exhaustive or legally binding.

Non-automotive qualified products — Unless this data sheet expressly states that this specific NXP Semiconductors product is automotive qualified, the product is not suitable for automotive use. It is neither qualified nor tested in accordance with automotive testing or application requirements. NXP Semiconductors accepts no liability for inclusion and/or use of non-automotive qualified products in automotive equipment or applications.

In the event that customer uses the product for design-in and use in automotive applications to automotive specifications and standards, customer (a) shall use the product without NXP Semiconductors' warranty of the product for such automotive applications, use and specifications, and (b) whenever customer uses the product for automotive applications beyond NXP Semiconductors' specifications such use shall be solely at customer's own risk, and (c) customer fully indemnifies NXP Semiconductors for any liability, damages or failed product claims resulting from customer design and use of the product for automotive applications beyond NXP Semiconductors' standard warranty and NXP Semiconductors' product specifications.

13.4 Trademarks

Notice: All referenced brands, product names, service names and trademarks are the property of their respective owners.

14. Contact information

For more information, please visit: <http://www.nxp.com>

For sales office addresses, please send an email to: salesaddresses@nxp.com

15. Contents

1	Product profile	1
1.1	General description	1
1.2	Features and benefits	1
1.3	Applications	1
1.4	Quick reference data	1
2	Pinning information	2
3	Ordering information	2
4	Marking	3
5	Functional diagram	3
6	Limiting values	4
7	Characteristics	4
7.1	Electrical characteristics	4
7.2	Frequency characteristics	6
8	Package outline	8
9	Packing information	9
10	Soldering	9
11	Design and assembly recommendations	10
11.1	PCB design guidelines	10
11.2	PCB assembly guidelines for Pb-free soldering	10
12	Revision history	12
13	Legal information	13
13.1	Data sheet status	13
13.2	Definitions	13
13.3	Disclaimers	13
13.4	Trademarks	14
14	Contact information	14
15	Contents	15

Please be aware that important notices concerning this document and the product(s) described herein, have been included in section 'Legal information'.

© NXP B.V. 2013.

All rights reserved.

For more information, please visit: <http://www.nxp.com>



For sales office addresses, please send an email to: salesaddresses@nxp.com

Date of release: 29 May 2013

Document identifier: IP3319CX6

Looking for pricing, stock, or lifecycle information?

Click below to explore more details on WIN SOURCE:

-  [View IP3319CX6,135 on WIN SOURCE](#)
-  [Nexperia USA Inc. Information](#)

Optimize Your Supply Chain with WIN SOURCE Solutions

-  Global Sourcing Solution
-  Obsolete Management
-  Cost Control Management
-  Shortage Management
-  Alternative Solution
-  Excess Inventory Management