



**1a/1c/2a/2c/5A/10A  
power relays  
for power supply**

# JW RELAYS



Protective construction: Flux-resistant type/Sealed type

### FEATURES

1. Miniature package with universal terminal footprint
2. High dielectric withstanding for transient protection:  
10,000 V surge in  $\mu$ s between coil and contact
3. Sealed construction
4. Class B coil insulation types available
5. VDE, TÜV, SEMKO, SEV, FIMKO also approved
6. Sockets are available

### TYPICAL APPLICATIONS

1. Home appliances  
TV sets, VCR, Microwave ovens
2. Office machines  
Photocopiers, Vending machines
3. Industrial equipment  
NC machines, Robots, Temperature controllers

### ORDERING INFORMATION

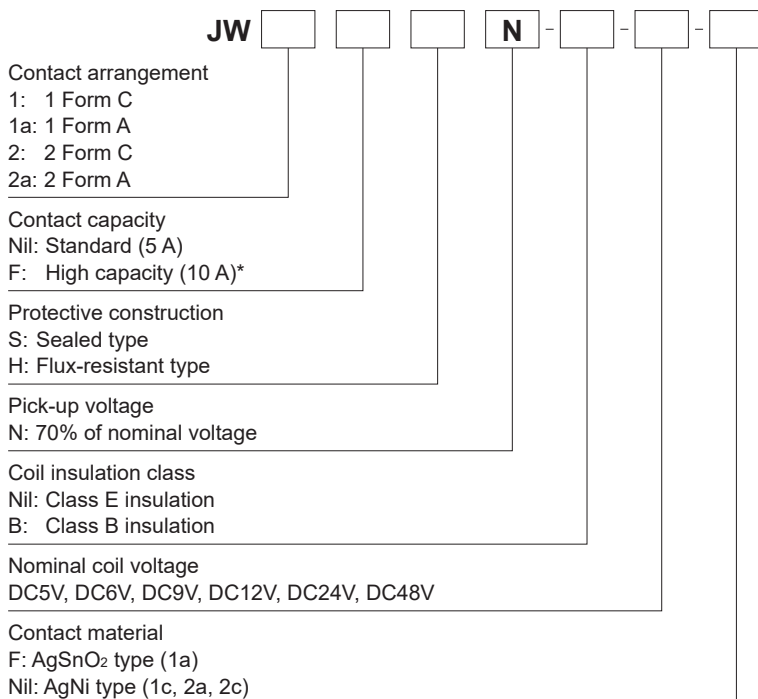

## TYPES

### 1) 1 Form A Standard (5A) type

Nominal coil voltage	Sealed type	Flux-resistant type
	Part No.	Part No.
5V DC	JW1aSN-DC5V-F	JW1aHN-DC5V-F
6V DC	JW1aSN-DC6V-F	JW1aHN-DC6V-F
9V DC	JW1aSN-DC9V-F	JW1aHN-DC9V-F
12V DC	JW1aSN-DC12V-F	JW1aHN-DC12V-F
24V DC	JW1aSN-DC24V-F	JW1aHN-DC24V-F
48V DC	JW1aSN-DC48V-F	JW1aHN-DC48V-F

Standard packing: Carton 100 pcs. Case 500 pcs.

### 3) 1 Form C Standard (5A) type

Nominal coil voltage	Sealed type	Flux-resistant type
	Part No.	Part No.
5V DC	JW1SN-DC5V	JW1HN-DC5V
6V DC	JW1SN-DC6V	JW1HN-DC6V
9V DC	JW1SN-DC9V	JW1HN-DC9V
12V DC	JW1SN-DC12V	JW1HN-DC12V
24V DC	JW1SN-DC24V	JW1HN-DC24V
48V DC	JW1SN-DC48V	JW1HN-DC48V

Standard packing: Carton 100 pcs. Case 500 pcs.

### 5) 2 Form A Standard (5A) type

Nominal coil voltage	Sealed type	Flux-resistant type
	Part No.	Part No.
5V DC	JW2aSN-DC5V	JW2aHN-DC5V
6V DC	JW2aSN-DC6V	JW2aHN-DC6V
9V DC	JW2aSN-DC9V	JW2aHN-DC9V
12V DC	JW2aSN-DC12V	JW2aHN-DC12V
24V DC	JW2aSN-DC24V	JW2aHN-DC24V
48V DC	JW2aSN-DC48V	JW2aHN-DC48V

Standard packing: Carton 100 pcs. Case 500 pcs.

### 2) 1 Form A High capacity (10 A) type

Nominal coil voltage	Sealed type	Flux-resistant type
	Part No.	Part No.
5V DC	JW1aFSN-DC5V-F	JW1aFHN-DC5V-F
6V DC	JW1aFSN-DC6V-F	JW1aFHN-DC6V-F
9V DC	JW1aFSN-DC9V-F	JW1aFHN-DC9V-F
12V DC	JW1aFSN-DC12V-F	JW1aFHN-DC12V-F
24V DC	JW1aFSN-DC24V-F	JW1aFHN-DC24V-F
48V DC	JW1aFSN-DC48V-F	JW1aFHN-DC48V-F

Standard packing: Carton 100 pcs. Case 500 pcs.

### 4) 1 Form C High capacity (10 A) type

Nominal coil voltage	Sealed type	Flux-resistant type
	Part No.	Part No.
5V DC	JW1FSN-DC5V	JW1FHN-DC5V
6V DC	JW1FSN-DC6V	JW1FHN-DC6V
9V DC	JW1FSN-DC9V	JW1FHN-DC9V
12V DC	JW1FSN-DC12V	JW1FHN-DC12V
24V DC	JW1FSN-DC24V	JW1FHN-DC24V
48V DC	JW1FSN-DC48V	JW1FHN-DC48V

Standard packing: Carton 100 pcs. Case 500 pcs.

### 6) 2 Form C Standard (5A) type

Nominal coil voltage	Sealed type	Flux-resistant type
	Part No.	Part No.
5V DC	JW2SN-DC5V	JW2HN-DC5V
6V DC	JW2SN-DC6V	JW2HN-DC6V
9V DC	JW2SN-DC9V	JW2HN-DC9V
12V DC	JW2SN-DC12V	JW2HN-DC12V
24V DC	JW2SN-DC24V	JW2HN-DC24V
48V DC	JW2SN-DC48V	JW2HN-DC48V

Standard packing: Carton 100 pcs. Case 500 pcs.

Note: Class B coil insulation type is available.

Ex) JW1aSN-B-DC12V-F

\* Sockets available.

## RATING

### 1.Coil data

- Operating characteristics such as 'Operate voltage' and 'Release voltage' are influenced by mounting conditions, ambient temperature, etc. Therefore, please use the relay within  $\pm 5\%$  of rated coil voltage.
- 'Initial' means the condition of products at the time of delivery.

Nominal coil voltage	Pick-up voltage (at 20°C 68°F)	Drop-out voltage (at 20°C 68°F)	Nominal operating current [ $\pm 10\%$ ] (at 20°C 68°F)	Coil resistance [ $\pm 10\%$ ] (at 20°C 68°F)	Nominal operating power	Max. applied voltage (at 20°C 68°F)
5V DC	70%V or less of nominal voltage (Initial)	10%V or more of nominal voltage (Initial)	106mA	47Ω	530mW	130%V of nominal voltage (at 60°C 140°F)  120%V of nominal voltage (at 85°C 185°F)**
6V DC			88mA	68Ω		
9V DC			58mA	155Ω		
12V DC			44mA	270Ω		
24V DC			22mA	1,100Ω		
48V DC			11mA	4,400Ω		

Note : The pick-up and drop out voltages rise approximately 0.4% for every 1°C 33.8°F given a standard ambient temperature of 20°C 68°F. Therefore, when using relays where the ambient temperature is high, please take into consideration the rise in pick-up and drop out voltages and keep the coil applied voltage within the maximum applied voltage.

## 2. Specifications

Characteristics	Item	Specifications	
		Standard type	High capacity type
Contact	Contact material	1 Form A: AgSnO2 type 1 Form C, 2 Form A and 2 Form C: AgNi type	
	Arrangement	1 Form A, 1 Form C, 2 Form A and 2 Form C	1 Form A and 1 Form C
	Contact resistance (Initial)	Max. 100 mΩ (By voltage drop 6 V DC 1A)	
Rating	Nominal switching capacity (resistive load)	5A 250V AC, 5A 30V DC	10A 250V AC, 10A 30V DC
	Max. switching power (resistive load)	1,250VA, 150W	2,500VA, 300W
	Max. switching voltage	250V AC, 30V DC	
	Max. switching current	5A	10A
	Min. switching capacity (reference value)*1	100mA, 5V DC	
Electrical characteristics	Insulation resistance (Initial)	Min. 1,000MΩ (at 500V DC) Measurement at same location as "Breakdown voltage" section.	
	Breakdown voltage (Initial)	Between open contacts	1,000 Vrms for 1 min. (Detection current: 10 mA)
		Between contact and coil	5,000 Vrms for 1 min. (Detection current: 10 mA)
		Between contact sets	3,000 Vrms for 1 min. (2 Form A, 2 Form C) (Detection current: 10 mA)
	Surge breakdown voltage*2 (Between contact and coil) (Initial)	10,000 V	
	Operate time (at nominal voltage) (at 20°C 68°F)	Max. 15 ms (excluding contact bounce time.)	
Release time (at nominal voltage) (at 20°C 68°F)	Max. 5 ms (excluding contact bounce time) (Without diode)		
Mechanical characteristics	Shock resistance	Functional	98 m/s <sup>2</sup> (Half-wave pulse of sine wave: 11 ms; detection time: 10μs.)
		Destructive	980 m/s <sup>2</sup> (Half-wave pulse of sine wave: 6 ms.)
	Vibration resistance	Functional	10 to 55 Hz at double amplitude of 1.6 mm (Detection time: 10μs.)
		Destructive	10 to 55 Hz at double amplitude of 2.0 mm
Expected life	Mechanical (at 180 times/min.)	Min. 5×10 <sup>6</sup>	
Conditions	Conditions for operation, transport and storage*3	Ambient temperature*4: -40°C to +60°C -40°F to 140°F (Class E), (Class B: -40°C to +85°C -40°F to 185°F) Humidity: 5 to 85% R.H. (Not freezing and condensing at low temperature)	
Unit weight		Approx. 13 g .46 oz	

\* Specifications will vary with foreign standards certification ratings.

Notes: \*1. This value can change due to the switching frequency, environmental conditions, and desired reliability level, therefore it is recommended to check this with the actual load.

\*2. Wave is standard shock voltage of ±1.2×50μs according to JEC-212-1981

\*3. The upper limit of the ambient temperature is the maximum temperature that can satisfy the coil temperature rise value. Refer to Usage, transport and storage conditions in NOTES.

\*4. The pick-up and drop out voltages rise approximately 0.4% for every 1°C 33.8°F given a standard ambient temperature of 20°C 68°F. Therefore, when using relays where the ambient temperature is high, please take into consideration the rise in pick-up and drop out voltages and keep the coil applied voltage within the maximum applied voltage.

## 3. Electrical life

Condition: Resistive load, at 6 times/min.

Types	Switching capacity	No. of operations
1 Form A, 1 Form C, 2 Form A, 2 Form C	5A 250V AC	Min. 1×10 <sup>5</sup>
	5A 30V DC	Min. 1×10 <sup>5</sup>
1 Form A, 1 Form C	10A 250V AC	Min. 1×10 <sup>5</sup>
	10A 30V DC	Min. 1×10 <sup>5</sup>

## REFERENCE DATA

### JW 1 Form A Standard (5A) type

#### 1. Maximum operating power

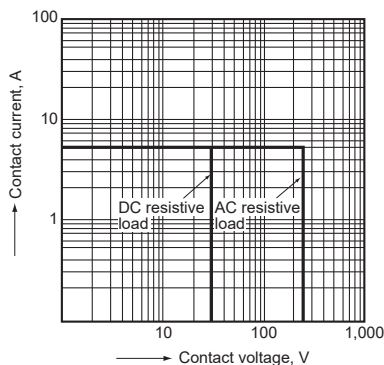

#### 2. Operate/release time

Sample: JW1aSN-DC12V-F, 10 pcs.

Ambient temperature: 20°C 68°F

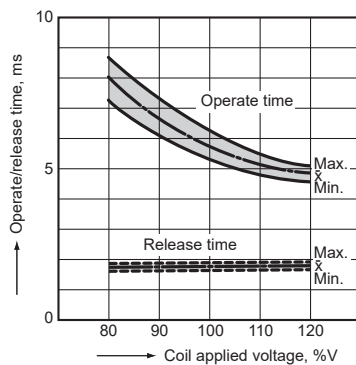

#### 3. Life curve

1 Form A Standard (5A) type

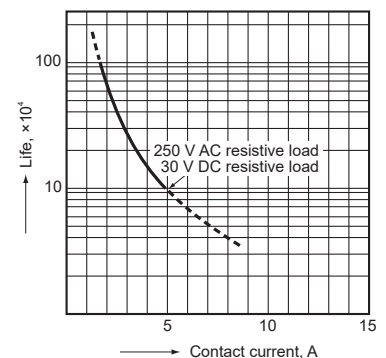

**JW 1 Form A High Capacity (10 A) type**  
 1. Maximum operating power

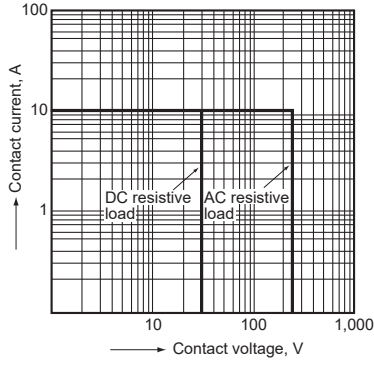

2. Operate/release time  
 Sample: JW1aFSN-DC12V, 10 pcs.  
 Ambient temperature: 20°C 68°F

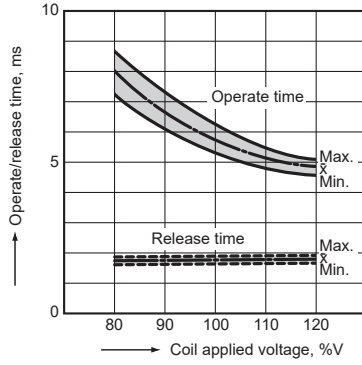

3. Life curve

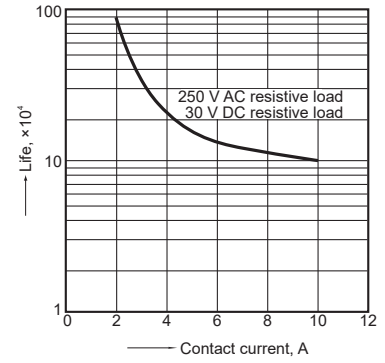

4-(1). Coil temperature rise  
 (Contact carrying current: 5A)  
 Sample JW1aFSN-DC12V-F  
 Point measured: Inside the coil

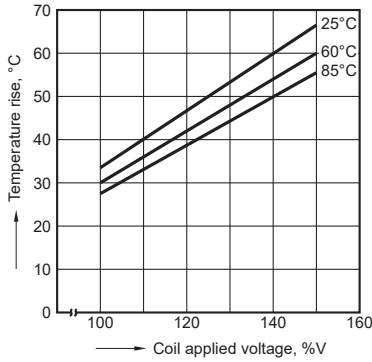

4-(2). Coil temperature rise  
 (Contact carrying current: 10 A)  
 Sample: JW1aFSN-DC12V-F  
 Point measured: Inside the coil

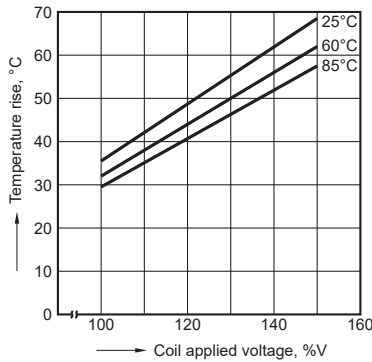

**JW 1 Form C Standard (5 A) type**  
 1-(3). Maximum operating power

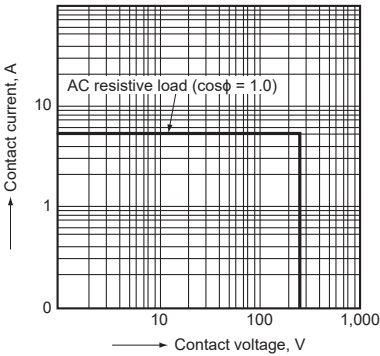

2. Operate/release time  
 Sample: JW1SN-DC12V-F, 6 pcs.  
 Ambient temperature: 20°C 68°F

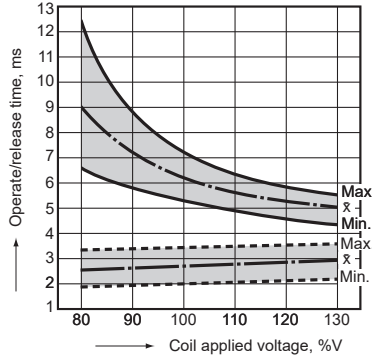

**JW 1 Form C High Capacity (10 A) type**  
 1. Maximum operating power

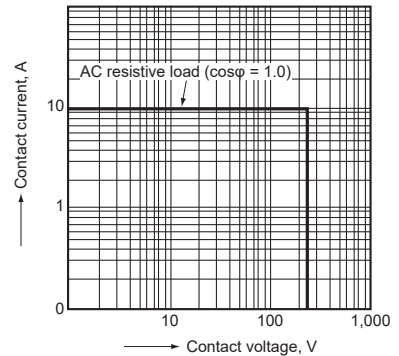

**JW 2 Form A Standard (5 A) type**  
 1. Maximum operating power

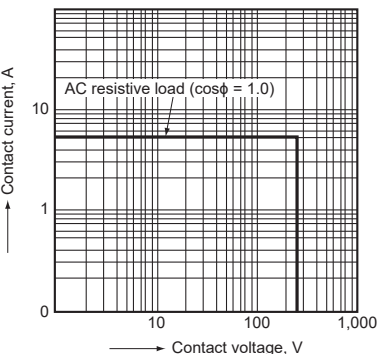

2. Operate/release time  
 Sample: JW2aSN-DC24V-F, 6 pcs.  
 Ambient temperature: 20°C 68°F

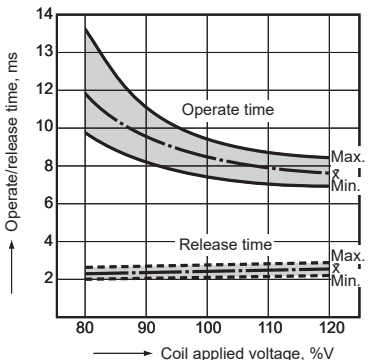

**JW 2 Form C Standard (5 A) type**

1. Maximum operating power

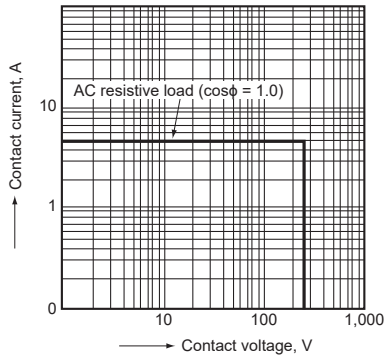

2. Operate/release time

Sample: JW2SN-DC12V-F, 6 pcs.  
Ambient temperature: 20°C 68°F

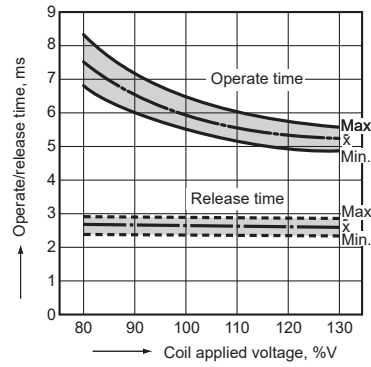

**DIMENSIONS (mm inch)**

**CAD** The CAD data of the products with a "CAD" mark can be downloaded from our Website.

**JW 1 Form A**

**CAD**

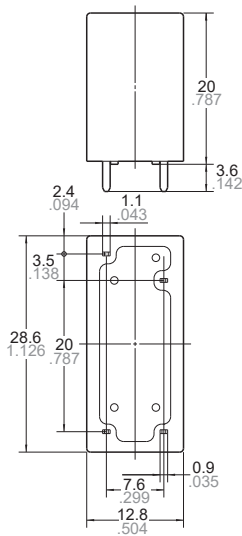

External dimensions

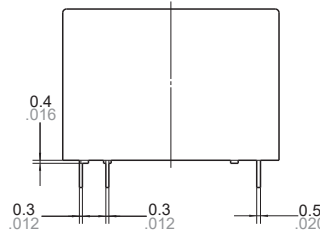

Dimension:	General tolerance
Less than 1mm .039inch:	±0.1 ±.004
Min. 1mm .039inch	
less than 3mm .118 inch:	±0.2 ±.008
Min. 3mm .118 inch:	±0.3 ±.012

Wiring diagram (Bottom view)

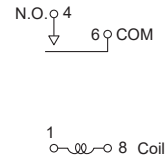

Note: Terminal numbers are not indicated on the relay.

PC board pattern (Bottom view)

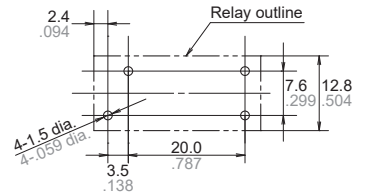

Tolerance: ±0.1 ±.004

**JW 1 Form A**

**CAD**

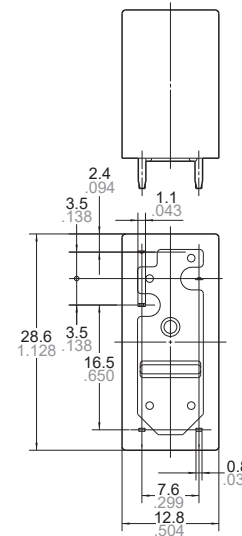

External dimensions

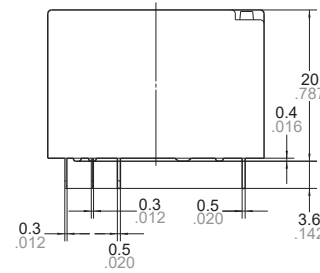

Dimension:	General tolerance
Less than 1mm .039inch:	±0.1 ±.004
Min. 1mm .039inch	
less than 3mm .118 inch:	±0.2 ±.008
Min. 3mm .118 inch:	±0.3 ±.012

Wiring diagram (Bottom view)

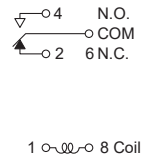

Note: Terminal numbers are not indicated on the relay.

PC board pattern (Bottom view)

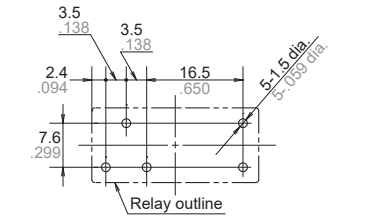

Tolerance: ±0.1 ±.004

JW 2 Form A and 2 Form C

CAD

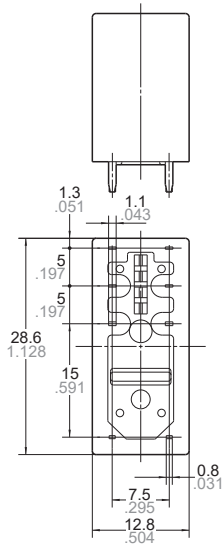

External dimensions

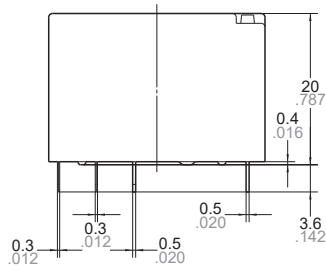

**Dimension:**  
 Less than 1mm .039inch:  $\pm 0.1 \pm 0.04$   
 Min. 1mm .039inch  
 less than 3mm .118 inch:  $\pm 0.2 \pm 0.08$   
 Min. 3mm .118 inch:  $\pm 0.3 \pm 0.12$

**General tolerance**

Wiring diagram (Bottom view)

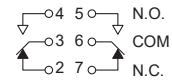

1  $\text{---} \text{---} \text{---}$  8 Coil

Note: Terminal numbers are not indicated on the relay.

PC board pattern (Bottom view)

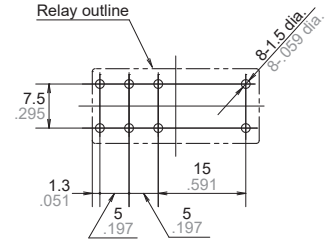

Note: JW 2 Form A is as shown in the diagram above except the N.C. terminals are not present.

Tolerance:  $\pm 0.1 \pm 0.04$

**SAFETY STANDARDS**

Types	UL/C-UL (Recognized)		CSA (Certified)		
	File No.	Contact rating	File No.	Contact rating	Cycles
Standard type 1 Form A	E43028	5A 277V AC	LR26550	5A 277V AC	—
		5A 30V DC		5A 30V DC	—
		1/8HP 250V AC		1/8HP 250V AC	10 <sup>5</sup>
		1/8HP 125V AC		1/8HP 125V AC	10 <sup>5</sup>
Standard type 1 Form C	E43028	5A 277V AC	LR26550	5A 277V AC	—
		5A 30V DC		5A 30V DC	—
		1/8HP 250V AC		1/8HP 250V AC	—
		1/8HP 125V AC		1/8HP 125V AC	—
Standard type 2 Form A	E43028	5A 277V AC	LR26550	5A 277V AC	—
		5A 30V DC		5A 30V DC	10 <sup>5</sup>
		1/8HP 250V AC		1/8HP 250V AC	—
		1/8HP 125V AC		1/8HP 125V AC	—
Standard type 2 Form C	E43028	5A 277V AC	LR26550	5A 277V AC	—
		5A 30V DC		5A 30V DC	10 <sup>5</sup>
		1/8HP 250V AC		1/8HP 250V AC	—
		1/8HP 125V AC		1/8HP 125V AC	—
High capacity type 1 Form A	E43028	10A 277V AC	LR26550	10A 277V AC	—
		10A 30V DC		10A 30V DC	—
		1/3HP 250V AC		1/3HP 250V AC	10 <sup>5</sup>
		1/3HP 125V AC		1/3HP 125V AC	10 <sup>5</sup>
High capacity type 1 Form C	E43028	10A 277V AC	LR26550	10A 277V AC	3×10 <sup>4</sup>
		10A 30V DC		10A 30V DC	3×10 <sup>4</sup>
		1/3HP 250V AC		1/3HP 250V AC	3×10 <sup>4</sup>
		1/3HP 125V AC		1/3HP 125V AC	3×10 <sup>4</sup>

Types	VDE (Certified)				CQC		
	File No.	Contact rating	Cycles	Temperature	File No.	Rating	Temperature
Standard type 1 Form A	40013854	5A 250V AC (cosφ =1.0)	5×10 <sup>4</sup>	85°C 185°F	CQC10002041727	5A 250V AC	60°C 140°F
		3A 250V AC (cosφ =0.4)	10 <sup>5</sup>	85°C 185°F			
Standard type 1 Form C	40013854	5A 250V AC (cosφ =1.0)	10 <sup>4</sup>	85°C 185°F		5A 250V AC	60°C 140°F
		5A 30V DC (0ms)	10 <sup>4</sup>	85°C 185°F			
		3A 250V AC (cosφ =0.4)	10 <sup>4</sup>	85°C 185°F			
Standard type 2 Form A	40013854	5A 250V AC (cosφ =1.0)	10 <sup>4</sup>	85°C 185°F		5A 250V AC	60°C 140°F
		5A 30V DC (0ms)	10 <sup>4</sup>	85°C 185°F			
		3A 250V AC (cosφ =0.4)	10 <sup>4</sup>	85°C 185°F			
Standard type 2 Form C	40013854	5A 250V AC (cosφ =1.0)	10 <sup>4</sup>	85°C 185°F		5A 250V AC	60°C 140°F
		5A 30V DC (0ms)	10 <sup>4</sup>	85°C 185°F			
		3A 250V AC (cosφ =0.4)	10 <sup>4</sup>	85°C 185°F			
High capacity type 1 Form A	40013854	10A 250V AC (cosφ =1.0)	5×10 <sup>4</sup>	85°C 185°F		10A 250V AC	60°C 140°F
		7A 250V AC (cosφ =0.4)	10 <sup>5</sup>	85°C 185°F			
High capacity type 1 Form C	40013854	10A 250V AC (cosφ =1.0)	10 <sup>4</sup>	85°C 185°F	10A 250V AC	60°C 140°F	
		10A 30V DC (0ms)	10 <sup>4</sup>	85°C 185°F			
		7A 250V AC (cosφ =0.4)	10 <sup>4</sup>	85°C 185°F			

## EN/IEC VDE Certified INSULATION CHARACTERISTICS (IEC61810-1)

Item	Characteristics
Clearance/Creepage distance (IEC61810-1)	Min. 5.5/8.0mm
Category of protection (IEC61810-1)	RT II, III
Tracking resistance (IEC60112)	PTI 175
Insulation material group	III a
Over voltage category	III
Rated voltage	250V
Pollution degree	3
Type of insulation (Between contact and coil)	Reinforced insulation
Type of insulation (Between open contacts)	Micro disconnection

### NOTES

1. For cautions for use, please read "GENERAL APPLICATION GUIDELINES".

Please refer to "the latest product specifications" when designing your product.  
 • Requests to customers :  
<https://industrial.panasonic.com/ac/e/salespolicies/>

# ACCESSORIES

## JW RELAY PC BOARD SOCKETS



### FEATURES

Space saving design

### TYPES

Product name	Number of poles	Part No.	Applicable relay type				Standard packing	
			1 Form A	1 Form C	2 Form A	2 Form C	Inner carton	Outer case
JW1 PC board socket	1	JW1-PS	•	•			10 pcs.	100 pcs.
JW2 PC board socket	2	JW2-PS			•	•		

### SPECIFICATIONS

Item	Type	PC board socket	
		1 pole	2 poles
Breakdown voltage		1,500 Vrms for 1 minute	
Insulation resistance		Min. 100 MΩ	

### DIMENSIONS (mm inch)

**CAD** The CAD data of the products with a "CAD" mark can be downloaded from our Website.

#### PC board socket

**CAD**

#### External dimensions

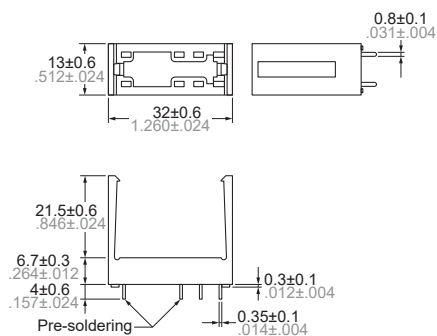

#### PC board pattern (Bottom view)

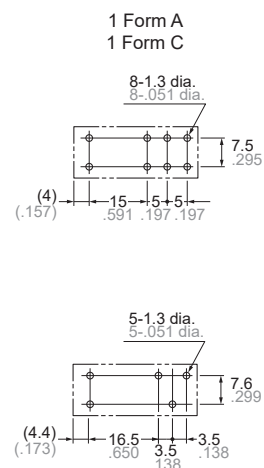

Tolerance: ±0.1 ±0.04

# GUIDELINES FOR POWER RELAYS AND HIGH-CAPACITY DC CUT OFF RELAYS USAGE

For cautions for use, please read “GUIDELINES FOR RELAY USAGE”.

[https://industrial.panasonic.com/ac/e/control/relay/cautions\\_use/index.jsp](https://industrial.panasonic.com/ac/e/control/relay/cautions_use/index.jsp)

## Precautions for Coil Input

### ■ Long term current carrying

A circuit that will be carrying a current continuously for long periods without relay switching operation. (circuits for emergency lamps, alarm devices and error inspection that, for example, revert only during malfunction and output warnings with form B contacts) Continuous, long-term current to the coil will facilitate deterioration of coil insulation and characteristics due to heating of the coil itself.

For circuits such as these, please use a magnetic-hold type latching relay. If you need to use a single stable relay, use a sealed type relay that is not easily affected by ambient conditions and make a failsafe circuit design that considers the possibility of contact failure or disconnection.

### ■ DC Coil operating power

Steady state DC current should be applied to the coil. The wave form should be rectangular. If it includes ripple, the ripple factor should be less than 5%.

However, please check with the actual circuit since the electrical characteristics may vary. The rated coil voltage should be applied to the coil and the set/reset pulse time of latching type relay differs for each relays, please refer to the relay's individual specifications.

### ■ Coil connection

When connecting coils of polarized relays, please check coil polarity (+,-) at the internal connection diagram (Schematic). If any wrong connection is made, it may cause unexpected malfunction, like abnormal heat, fire and so on, and circuit do not work. Avoid impressing voltages to the set coil and reset coil at the same time.

## Ambient Environment

### ● Usage, Transport, and Storage Conditions

During usage, storage, or transportation, avoid locations subjected to direct sunlight and maintain normal temperature, humidity and pressure conditions.

### ● Temperature/Humidity/Pressure

When transporting or storing relays while they are tube packaged, there are cases the temperature may differ from the allowable range. In this case be sure to check the individual specifications. Also allowable humidity level is influenced by temperature, please check charts shown below and use relays within mentioned conditions. (Allowable temperature values differ for each relays, please refer to the relay's individual specifications.)

#### 1) Temperature:

The tolerance temperature range differs for each relays, please refer to the relay's individual specifications

#### 2) Humidity:

5 to 85 % RH

#### 3) Pressure:

86 to 106 kPa

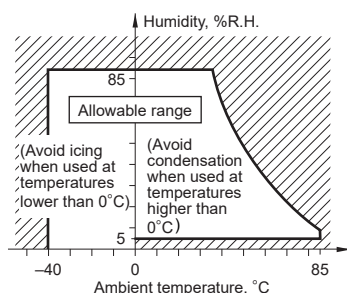

### ■ Maximum allowable voltage and temperature rise

Proper usage requires that the rated coil voltage be impressed on the coil. Note, however, that if a voltage greater than or equal to the maximum continuous voltage is impressed on the coil, the coil may burn or its layers short due to the temperature rise. Furthermore, do not exceed the usable ambient temperature range listed in the catalog.

### ■ Operate voltage change due to coil temperature rise (Hot start)

In DC relays, after continuous passage of current in the coil, if the current is turned OFF, then immediately turned ON again, due to the temperature rise in the coil, the pick-up voltage will become somewhat higher. Also, it will be the same as using it in a higher temperature atmosphere. The resistance/temperature relationship for copper wire is about 0.4% for 1°C, and with this ratio the coil resistance increases. That is, in order to operate of the relay, it is necessary that the voltage be higher than the pick-up voltage and the pick-up voltage rises in accordance with the increase in the resistance value. However, for some polarized relays, this rate of change is considerably smaller.

### ● Dew condensation

Condensation occurs when the ambient temperature drops suddenly from a high temperature and humidity, or the relay is suddenly transferred from a low ambient temperature to a high temperature and humidity. Condensation causes the failures like insulation deterioration, wire disconnection and rust etc. Panasonic Corporation does not guarantee the failures caused by condensation.

The heat conduction by the equipment may accelerate the cooling of device itself, and the condensation may occur.

Please conduct product evaluations in the worst condition of the actual usage. (Special attention should be paid when high temperature heating parts are close to the device. Also please consider the condensation may occur inside of the device.)

### ● Icing

Condensation or other moisture may freeze on relays when the temperature become lower than 0°C. This icing causes the sticking of movable portion, the operation delay and the contact conduction failure etc. Panasonic Corporation does not guarantee the failures caused by the icing.

The heat conduction by the equipment may accelerate the cooling of relay itself and the icing may occur. Please conduct product evaluations in the worst condition of the actual usage.

### ● Low temperature and low humidity

The plastic becomes brittle if the switch is exposed to a low temperature, low humidity environment for long periods of time.

### ● High temperature and high humidity

Storage for extended periods of time (including transportation periods) at high temperature or high humidity levels or in atmospheres with organic gases or sulfide gases may cause a sulfide film or oxide film to form on the surfaces of the contacts and/or it may interfere with the functions. Check out the atmosphere in which the units are to be stored and transported.

# GUIDELINES FOR POWER RELAYS AND HIGH-CAPACITY DC CUT OFF RELAYS USAGE

## ●Package

In terms of the packing format used, make every effort to keep the effects of moisture, organic gases and sulfide gases to the absolute minimum.

## ●Silicon

When a source of silicone substances (silicone rubber, silicone oil, silicone coating materials and silicone filling materials etc.) is used around the relay, the silicone gas (low molecular siloxane etc.) may be produced.

This silicone gas may penetrate into the inside of the relay. When the relay is kept and used in this condition, silicone compound may adhere to the relay contacts which may cause the contact failure. Do not use any sources of silicone gas around the relay (Including plastic seal types).

## ●NOx Generation

When relay is used in an atmosphere high in humidity to switch a load which easily produces an arc, the NOx created by the arc and the water absorbed from outside the relay combine to produce nitric acid. This corrodes the internal metal parts and adversely affects operation. Avoid use at an ambient humidity of 85%RH or higher (at 20°C). If use at high humidity is unavoidable, please contact our sales representative.

## Others

### ■Cleaning

- 1) Although the environmentally sealed type relay (plastic sealed type, etc.) can be cleaned, avoid immersing the relay into cold liquid (such as cleaning solvent) immediately after soldering. Doing so may deteriorate the sealing performance.
- 2) Cleaning with the boiling method is recommended(The temperature of cleaning liquid should be 40°C or lower ).  
Avoid ultrasonic cleaning on relays. Use of ultrasonic cleaning may cause breaks in the coil or slight sticking of the contacts due to ultrasonic energy.

Please refer to "**the latest product specifications**" when designing your product.

•Requests to customers:

<https://industrial.panasonic.com/ac/e/salespolicies/>

---

Please contact .....

**Panasonic Corporation**

Electromechanical Control Business Division



■ 1006, Oaza Kadoma, Kadoma-shi, Osaka 571-8506, Japan  
[industrial.panasonic.com/ac/e/](http://industrial.panasonic.com/ac/e/)

**Panasonic**<sup>®</sup>

©Panasonic Corporation 2019

## Looking for pricing, stock, or lifecycle information?

Click below to explore more details on WIN SOURCE:

-  [View JW2SN-DC5V on WIN SOURCE](#)
-  [Panasonic Information](#)

## Optimize Your Supply Chain with WIN SOURCE Solutions

-  Global Sourcing Solution
-  Obsolete Management
-  Cost Control Management
-  Shortage Management
-  Alternative Solution
-  Excess Inventory Management