



**THE DATASHEET OF
CM1454-08CP**



CM1454

Data Port EMI Filter Array with ESD Protection

Description

The CM1454 is an EMI filter array with ESD protection in a CSP form factor for the data port of a mobile handset. The CM1454-08 is configured in an 8 channel format and combines both resistor-capacitor (R-C) and inductor-capacitor (L-C) filters in the chip. There are five C-R-C filters with component values of 30 pF – 100 Ω – 30 pF which are used for the microphone and data ports. There are also three C-L-C filters with values of 80 pF – 3 nH – 80 pF which are designed for the stereo speaker port.

The CM1454's C-RC filters have a cut-off frequency of 60 MHz and an attenuation of better than 35 dB over the 800 MHz to 2.7 GHz frequency range. The C-L-C filters have a cut-off frequency of 21 MHz with an attenuation of 40 dB at 1 GHz. The parts integrate ESD protection diodes on every pin that provide a very high level of protection for sensitive electronic components against possible electrostatic discharge (ESD). The ESD protection diodes connected to the filter ports are designed and characterized to safely dissipate ESD strikes of ±15 kV, which is beyond the Level 4 requirement of the IEC61000-4-2 international standard. In accordance with MIL-STD-883 (Method 3015) specification for Human Body Model (HBM) ESD, the pins are also protected for contact discharges at greater than ±30 kV.

The CM1454 incorporates *OptiGuard™* which results in improved reliability at assembly. The CM1454 is available in a space saving, low profile Chip Scale Package with RoHS compliant lead-free finishing.

Features

- *OptiGuard™* Coated for Improved Reliability
- Eight Channels of EMI Filtering
- Three C-L-C Filters with ESD Protection for Stereo Speaker Port
- Five C-R-C Filters with ESD Protection for Microphone and Data Ports
- ±15 kV ESD Protection on Each Channel (IEC 61000-4-2 Level 4, Contact Discharge)
- ±30 kV ESD Protection on Each Channel (HBM)
- Chip Scale Package (CSP) Features Extremely Low Parasitic Inductance for Optimum Filter and ESD Performance
- 20-Bump, 3.960 mm x 1.586 mm Footprint CSP
- These Devices are Pb-Free and are RoHS Compliant

Applications

- Combination I/O Data Port that has I/Os for Data, Microphone and Speaker
- I/O Port Protection for Mobile Handsets, Notebook Computers, PDAs, etc.
- EMI Filtering for Data Ports in Cell Phones, PDAs or Notebook Computers
- Wireless Handsets
- Handheld PCs / PDAs



ON Semiconductor®

<http://onsemi.com>



WLCSP20
CP SUFFIX
CASE 567BY

MARKING DIAGRAM

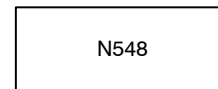

CM1454-08
20-Bump CSP Package

N548 = CM1454-08CP

ORDERING INFORMATION

Device	Package	Shipping†
CM1454-08CP	CSP-20 (Pb-Free)	3500/Tape & Reel

†For information on tape and reel specifications, including part orientation and tape sizes, please refer to our Tape and Reel Packaging Specification Brochure, BRD8011/D.

CM1454

ELECTRICAL SCHEMATIC

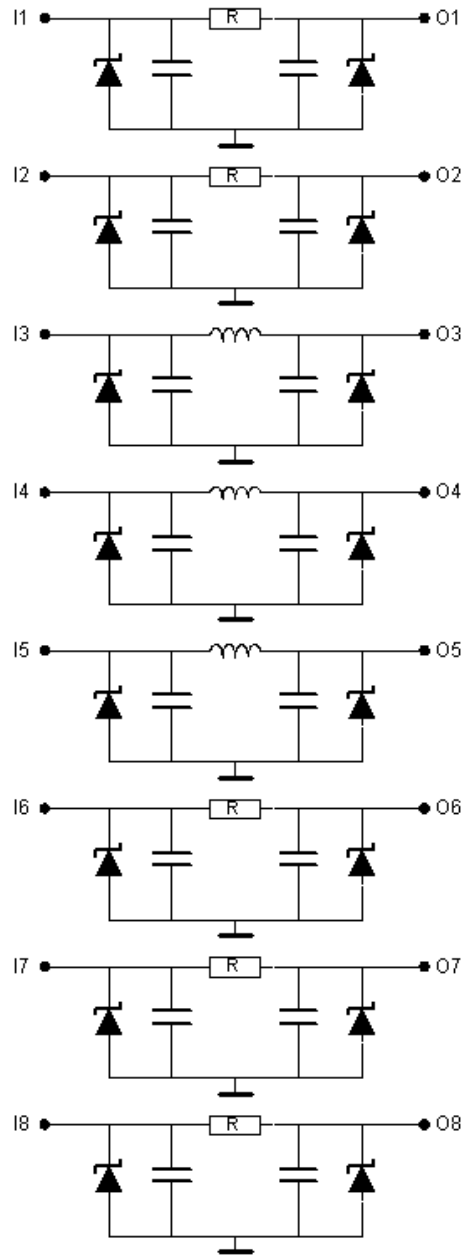

Figure 1. CM1454 Schematic Diagram of R-C and L-C Filter Arrays with ESD

CM1454

PACKAGE / PINOUT DIAGRAMS

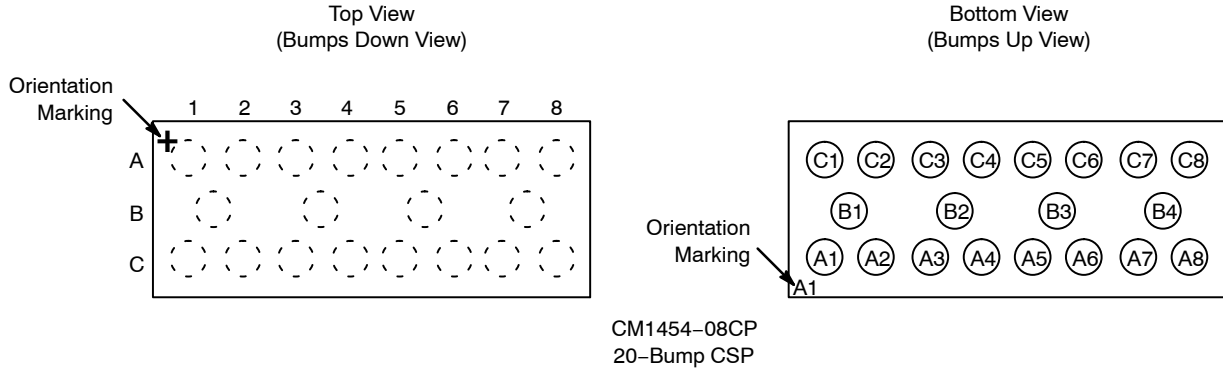

Table 1. PIN DESCRIPTIONS

Pin Number	Pin Description	Pin Number	Pin Description
A1	Filter #1 (Microphone)	C1	Filter #1
A2	Filter #2 (Microphone)	C2	Filter #2
A3	Filter #3 (Stereo Headphone)	C3	Filter #3
A4	Filter #4 (Left Speaker)	C4	Filter #4
A5	Filter #5 (Right Speaker)	C5	Filter #5
A6	Filter #6 (Accessory ID)	C6	Filter #6
A7	Filter #7 (Data)	C7	Filter #7
A8	Filter #8 (Data)	C8	Filter #8
B1-B4	GND		

SPECIFICATIONS

Table 2. ABSOLUTE MAXIMUM RATINGS

Parameter	Rating	Units
Storage Temperature Range	-65 to +150	°C
DC current per Inductor	30	mA
DC Package Power Rating	0.5	W

Stresses exceeding Maximum Ratings may damage the device. Maximum Ratings are stress ratings only. Functional operation above the Recommended Operating Conditions is not implied. Extended exposure to stresses above the Recommended Operating Conditions may affect device reliability.

Table 3. STANDARD OPERATING CONDITIONS

Parameter	Rating	Units
Operating Temperature Range	-40 to +85	°C

CM1454

Table 4. ELECTRICAL OPERATING CHARACTERISTICS (Note 1)

Symbol	Parameter	Conditions	Min	Typ	Max	Units
R	Resistance		80	100	120	Ω
C ₁	Capacitance	2.5 V dc; 1 MHz, 30 mV ac	24	30	36	pF
L	Inductance			3.0		nH
R _E	Equivalent Series Resistance of Inductor			0.25		Ω
C ₂	Capacitance	0 V dc, 1 MHz, 30 mV ac;	100	125	150	pF
		2.5 V dc, 1 MHz, 30 mV ac;	64	80	96	pF
f _{RC}	Cut-off Frequency Z _{SOURCE} = 50 Ω , Z _{LOAD} = 50 Ω			60		MHz
f _{LC}	Cut-off Frequency Z _{SOURCE} = 50 Ω , Z _{LOAD} = 50 Ω			21		MHz
V _{ST}	Stand-off Voltage	I = 10 μ A		6.0		V
I _{LEAK}	Diode Leakage Current	V _{IN} = 3.3 V		0.1	1.0	μ A
V _{SIG}	Signal Clamp Voltage Positive Clamp Negative Clamp	I _{LOAD} = 10 mA	5.6	6.8	9.0	V
		I _{LOAD} = -10 mA	-1.5	-0.8	-0.4	
V _{ESD}	In-system ESD Withstand Voltage a) Human Body Model, MIL-STD-883, Method 3015 b) Contact Discharge per IEC 61000-4-2 Level 4	(Notes 2 and 3)	\pm 30			kV
			\pm 15			
R _{DYN}	Dynamic Resistance Positive Negative			2.3		Ω
				0.9		

1. T_A = 25°C unless otherwise specified.
2. ESD applied to input and output pins with respect to GND, one at a time.
3. Unused pins are left open.

PERFORMANCE INFORMATION

Diode Characteristics (nominal conditions unless specified otherwise)

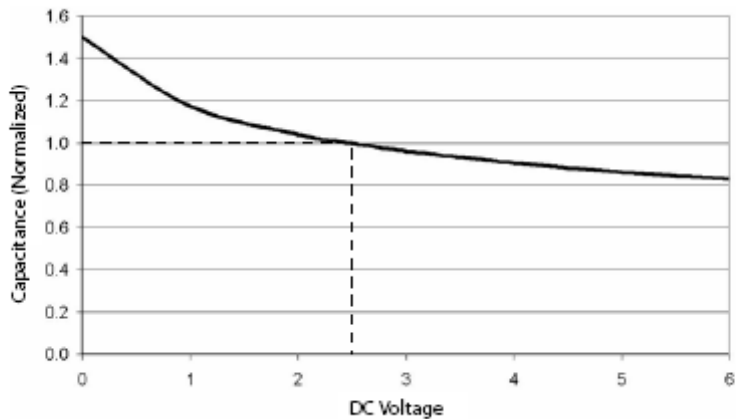

Figure 2. Typical Diode Capacitance vs. Input Voltage (normalized to 2.5 VDC)

CM1454

PERFORMANCE INFORMATION (Cont'd)

Typical Filter Performance (nominal conditions unless specified otherwise, 50 Ω Environment)

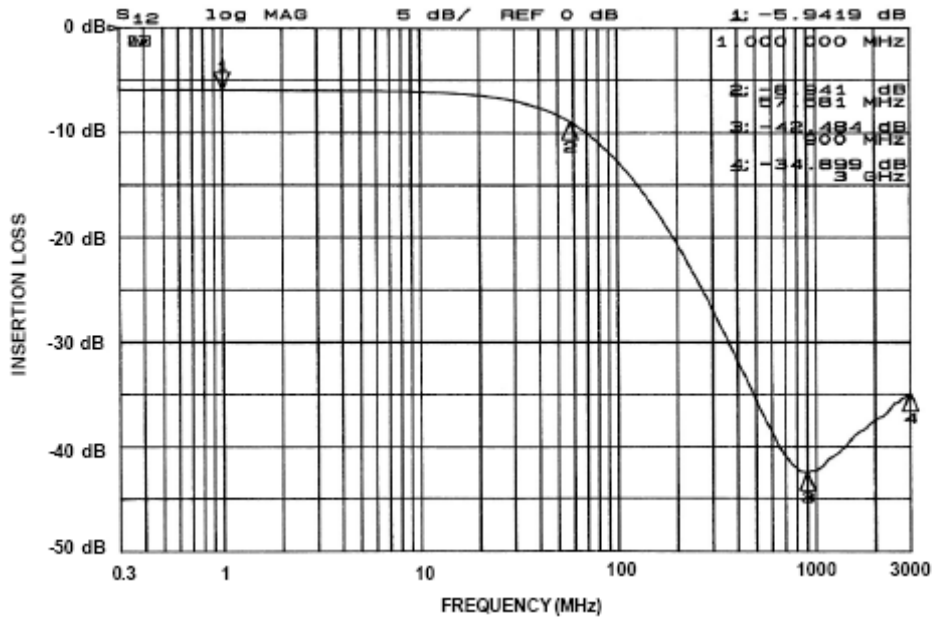

Figure 3. Attenuation Curve for CM1454 RC Filters: 1, 2, 6, 7, and 8

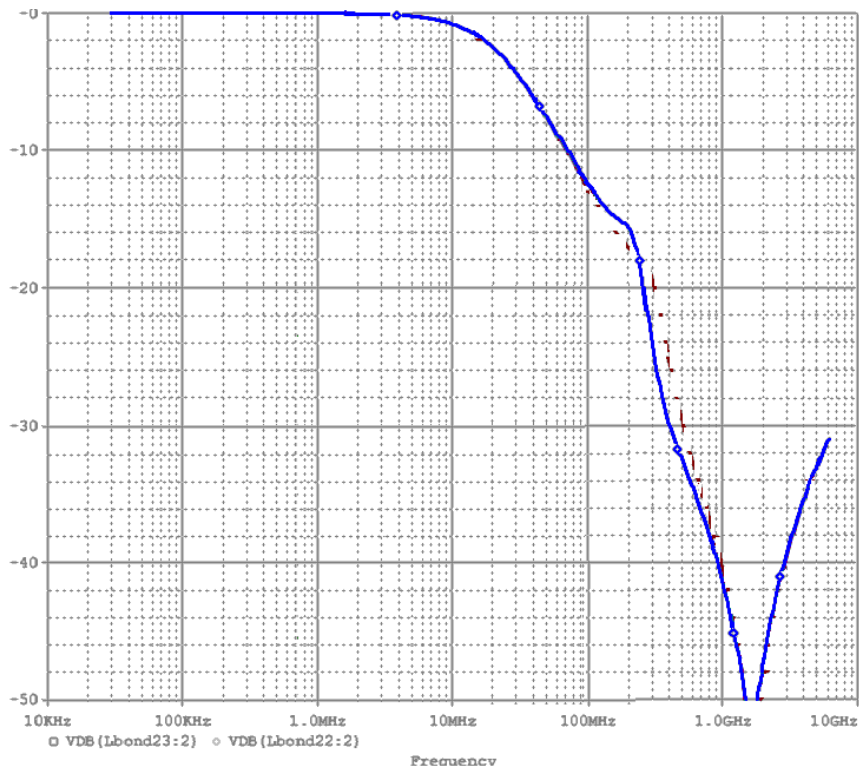

Figure 4. Attenuation Curve for CM1454 RC Filters: 3, 4, and 5

APPLICATION INFORMATION

Table 5. PRINTED CIRCUIT BOARD RECOMMENDATIONS

Parameter	Value
Pad Size on PCB	0.240 mm
Pad Shape	Round
Pad Definition	Non-Solder Mask defined pads
Solder Mask Opening	0.290 mm Round
Solder Stencil Thickness	0.125 – 0.150 mm
Solder Stencil Aperture Opening (laser cut, 5% tapered walls)	0.300 mm Round
Solder Flux Ratio	50/50 by volume
Solder Paste Type	No Clean
Pad Protective Finish	OSP (Entek Cu Plus 106A)
Tolerance – Edge To Corner Ball	±50 µm
Solder Ball Side Coplanarity	±20 µm
Maximum Dwell Time Above Liquidous	60 seconds
Maximum Soldering Temperature for Lead-free Devices using a Lead-free Solder Paste	260°C

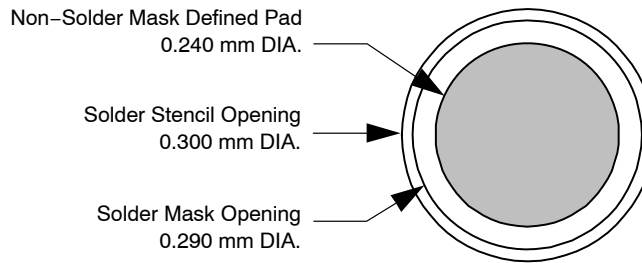

Figure 5. Recommended Non-Solder Mask Defined Pad Illustration

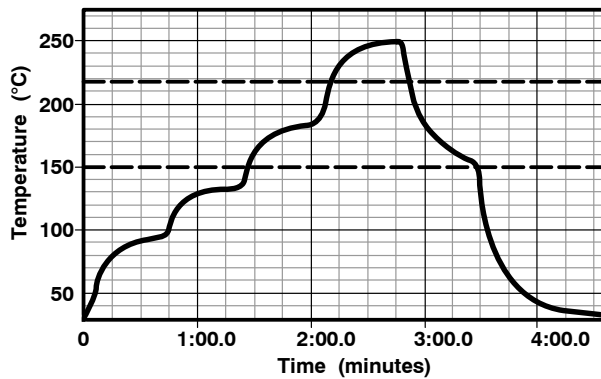
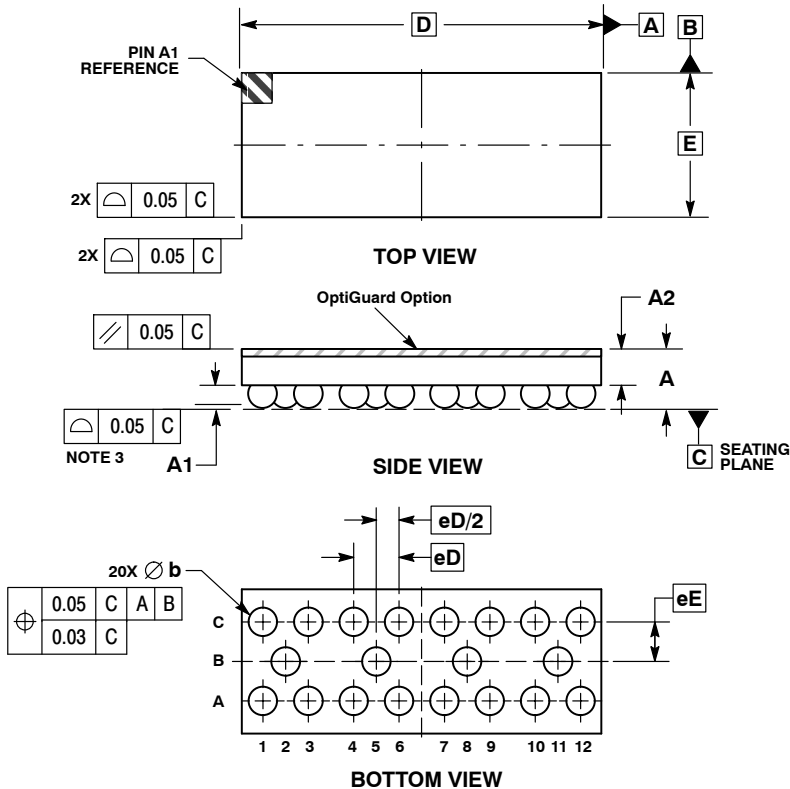

Figure 6. Lead-free (SnAgCu) Solder Ball Reflow Profile

CM1454

PACKAGE DIMENSIONS

WLCSP20, 3.96x1.59
CASE 567BY-01
ISSUE O



NOTES:

1. DIMENSIONING AND TOLERANCING PER ASME Y14.5M, 1994.
2. CONTROLLING DIMENSION: MILLIMETERS.
3. COPLANARITY APPLIES TO SPHERICAL CROWNS OF SOLDER BALLS.

DIM	MILLIMETERS	
	MIN	MAX
A	0.56	0.72
A1	0.21	0.27
A2	0.42	REF
b	0.29	0.35
D	3.96	BSC
E	1.59	BSC
eD	0.50	BSC
eE	0.435	BSC

RECOMMENDED SOLDERING FOOTPRINT*

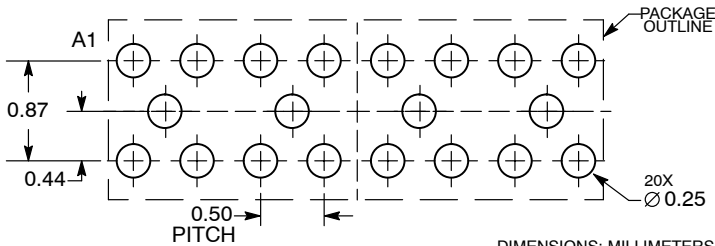

*For additional information on our Pb-Free strategy and soldering details, please download the ON Semiconductor Soldering and Mounting Techniques Reference Manual, SOLDERRM/D.

OptiGuard™ is a trademark of Semiconductor Components Industries, LLC.

ON Semiconductor and are registered trademarks of Semiconductor Components Industries, LLC (SCILLC). SCILLC reserves the right to make changes without further notice to any products herein. SCILLC makes no warranty, representation or guarantee regarding the suitability of its products for any particular purpose, nor does SCILLC assume any liability arising out of the application or use of any product or circuit, and specifically disclaims any and all liability, including without limitation special, consequential or incidental damages. "Typical" parameters which may be provided in SCILLC data sheets and/or specifications can and do vary in different applications and actual performance may vary over time. All operating parameters, including "Typicals" must be validated for each customer application by customer's technical experts. SCILLC does not convey any license under its patent rights nor the rights of others. SCILLC products are not designed, intended, or authorized for use as components in systems intended for surgical implant into the body, or other applications intended to support or sustain life, or for any other application in which the failure of the SCILLC product could create a situation where personal injury or death may occur. Should Buyer purchase or use SCILLC products for any such unintended or unauthorized application, Buyer shall indemnify and hold SCILLC and its officers, employees, subsidiaries, affiliates, and distributors harmless against all claims, costs, damages, and expenses, and reasonable attorney fees arising out of, directly or indirectly, any claim of personal injury or death associated with such unintended or unauthorized use, even if such claim alleges that SCILLC was negligent regarding the design or manufacture of the part. SCILLC is an Equal Opportunity/Affirmative Action Employer. This literature is subject to all applicable copyright laws and is not for resale in any manner.

PUBLICATION ORDERING INFORMATION

LITERATURE FULFILLMENT:
Literature Distribution Center for ON Semiconductor
P.O. Box 5163, Denver, Colorado 80217 USA
Phone: 303-675-2175 or 800-344-3860 Toll Free USA/Canada
Fax: 303-675-2176 or 800-344-3867 Toll Free USA/Canada
Email: orderlit@onsemi.com

N. American Technical Support: 800-282-9855 Toll Free
USA/Canada
Europe, Middle East and Africa Technical Support:
Phone: 421 33 790 2910
Japan Customer Focus Center
Phone: 81-3-5773-3850

ON Semiconductor Website: www.onsemi.com
Order Literature: <http://www.onsemi.com/orderlit>
For additional information, please contact your local Sales Representative

Looking for pricing, stock, or lifecycle information?

Click below to explore more details on WIN SOURCE:

- ⊖ [View CM1454-08CP](#) on WIN SOURCE
- ⊖ [ON Semiconductor](#) Information

Optimize Your Supply Chain with WIN SOURCE Solutions

- ✓ Global Sourcing Solution
- ✓ Obsolete Management
- ✓ Cost Control Management
- ✓ Shortage Management
- ✓ Alternative Solution
- ✓ Excess Inventory Management