



**THE DATASHEET OF
ESD8V0R1B-02LRH E6433**



Bi-directional Low Capacitance TVS Diode

- ESD / transient protection of high-speed data lines in 3.3 / 5 / 12 V applications according to:
IEC61000-4-2 (ESD): ± 18 kV (air) ± 15 kV (contact)
IEC61000-4-4 (EFT): 40 A (5 / 50 ns)
- Extremely small form factor down to $0.62 \times 0.32 \times 0.31$ mm³ (0201)
- Max. working voltage: $-8 / +14$ V
- Very low reverse current < 1 nA typ.
- Very low series inductance down to 0.2 nH typ.
- Low capacitance of 4 pF typ.
- Pb-free (RoHS compliant) package
- Qualified according AEC Q101

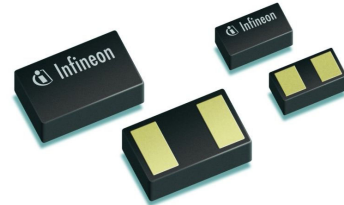
Applications

- USB 2.0, 10/100 Ethernet, Firewire, DVI
- Mobile communication
- Consumer products (STB, MP3, DVD, DSC...)
- LCD displays, camera
- Notebooks and desktop computers, peripherals

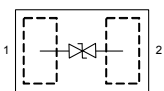
ESD8V0R1B-02LS
ESD8V0R1B-02LRH

Type	Package	Configuration	Marking
ESD8V0R1B-02LRH	TSLP-2-17	1 line, bi-directional	E
ESD8V0R1B-02LS	TSSLP-2-1	1 line, bi-directional	E

Maximum Ratings at $T_A = 25^\circ\text{C}$, unless otherwise specified

Parameter	Symbol	Value	Unit
ESD discharge ¹⁾ air contact	V_{ESD}	18 15	kV
Peak pulse current ($t_p = 8 / 20 \mu\text{s}$) ²⁾	I_{pp}	1	A
Operating temperature range	T_{op}	-55...150	°C
Storage temperature	T_{stg}	-65...150	

Electrical Characteristics at $T_A = 25^\circ\text{C}$, unless otherwise specified

Parameter	Symbol	Values			Unit
		min.	typ.	max.	

Characteristics

Reverse working voltage, from pin 2 to 1	V_{RWM}	-8	-	14	V
Breakdown voltage	$V_{(\text{BR})}$				
$I_{(\text{BR})} = 1 \text{ mA}$, from pin 2 to 1 $I_{(\text{BR})} = 1 \text{ mA}$, from pin 1 to 2		14.5 8.5	17 11	20 14	
Reverse current $V_R = 3.3 \text{ V}$	I_R	-	<1	50	nA
Clamping voltage $I_{\text{PP}} = 1 \text{ A}$, $t_p = 8/20 \mu\text{s}$, from pin 2 to 1 ²⁾ $I_{\text{PP}} = 1 \text{ A}$, $t_p = 8/20 \mu\text{s}$, from pin1 to 2 ²⁾	V_{CL}	- -	23 17	28 22	V
Line capacitance $V_R = 0 \text{ V}$, $f = 1 \text{ MHz}$	C_T	-	4	7	
Series inductance ESD8V0R1B-02LS ESD8V0R1B-02LRH	L_S	- -	0.2 0.4	- -	nH

¹⁾ V_{ESD} according to IEC61000-4-2

²⁾ I_{pp} according to IEC61000-4-5

Non-repetitive peak pulse power

$P_{pk} = f(t_p)$

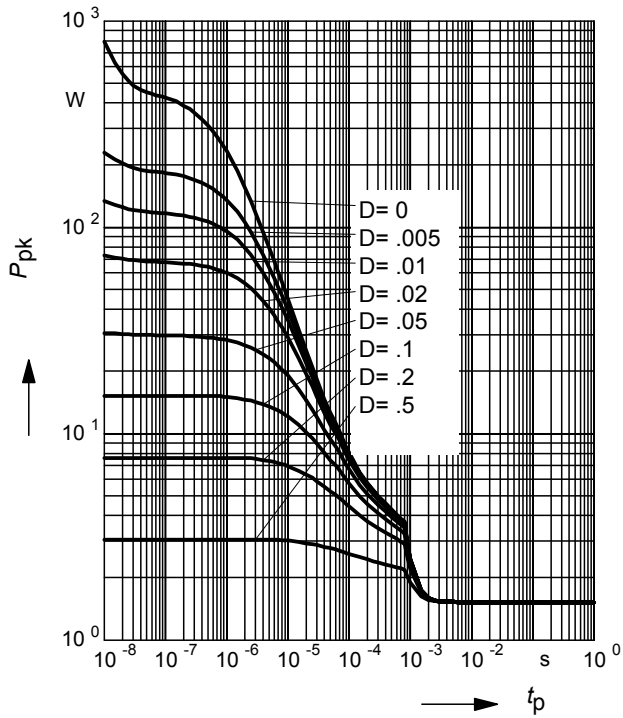

Power derating curve $P_{pk} = f(T_A)$

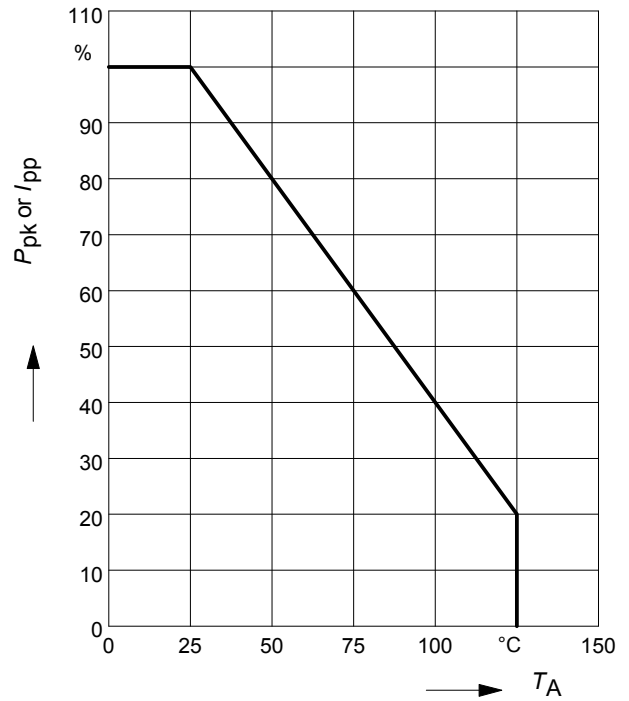

Reverse current $I_R = f(V_R)$

$T_A = \text{Parameter}$

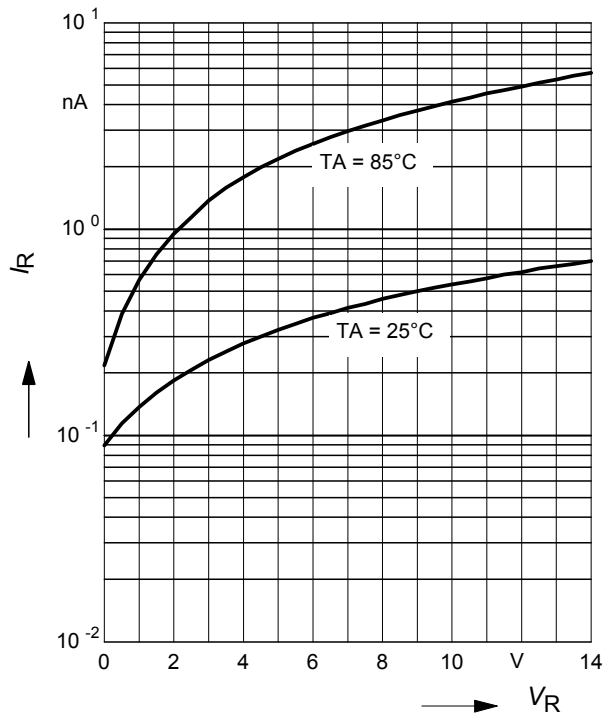

Diode capacitance $C_T = f(V_R)$

$f = 1\text{MHz}$

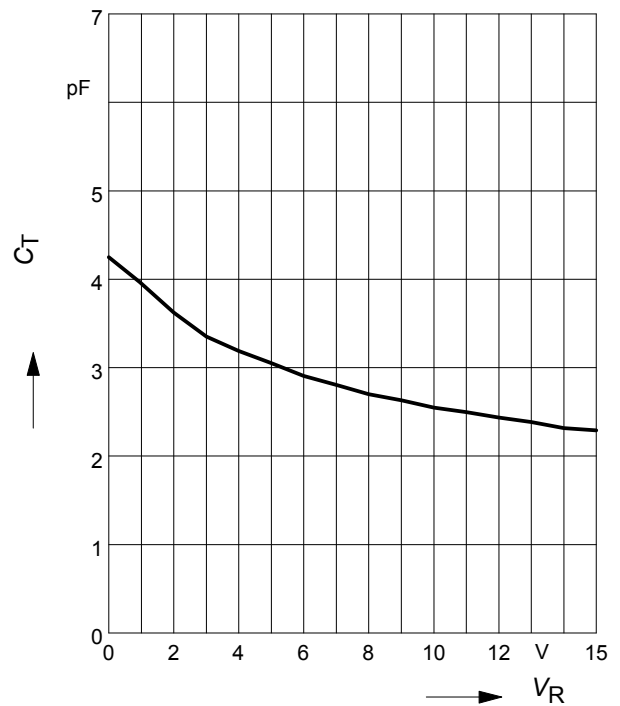

Application example ESD8V0R1B...

1 line, bi-directional

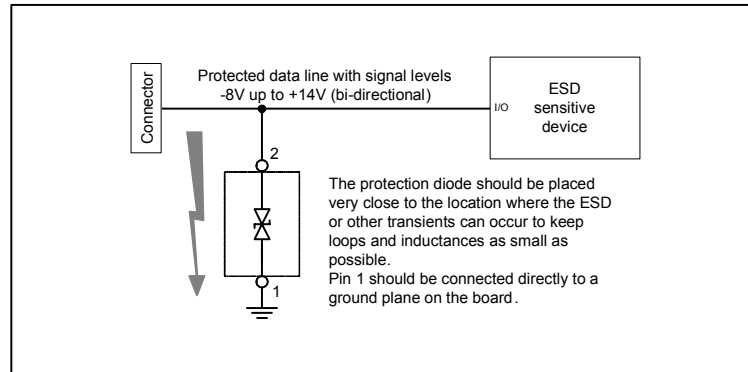

Package Outline

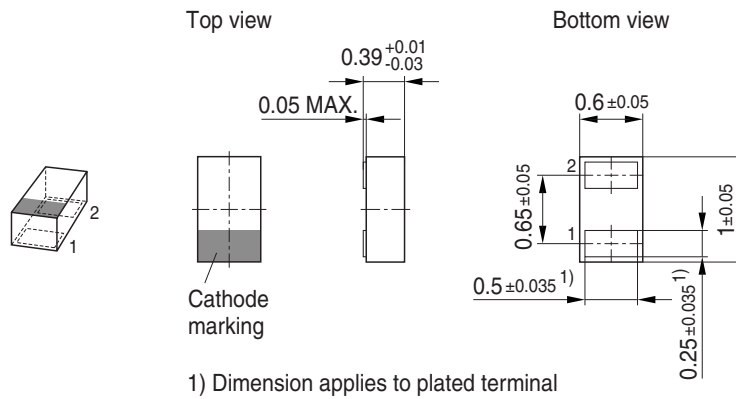

Foot Print

For board assembly information please refer to Infineon website "Packages"

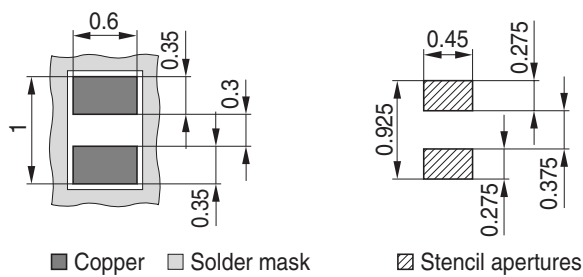

Marking Layout (Example)

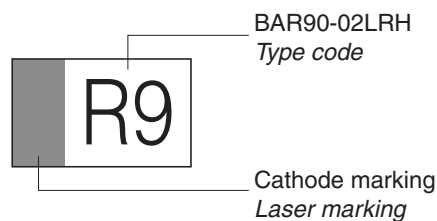

Standard Packing

Reel ø180 mm = 15.000 Pieces/Reel
 Reel ø330 mm = 50.000 Pieces/Reel (optional)

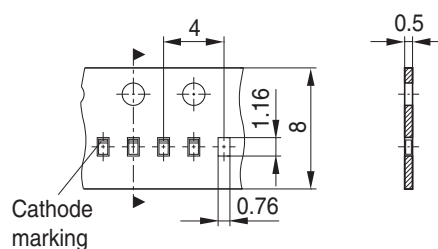

Package Outline

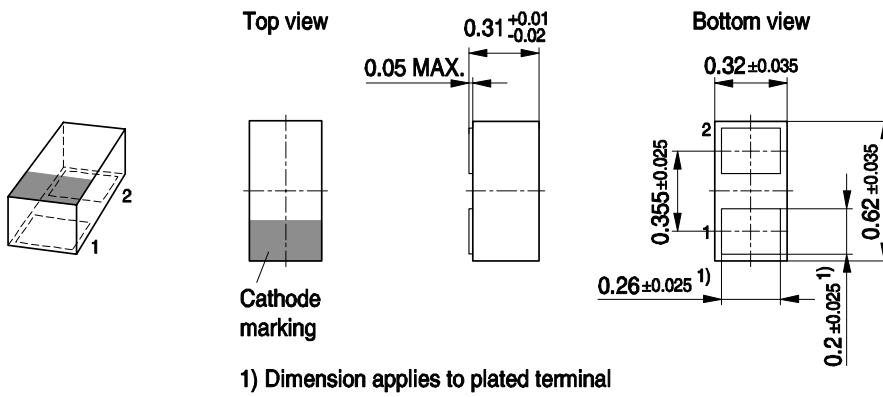

Foot Print

For board assembly information please refer to Infineon website "Packages"

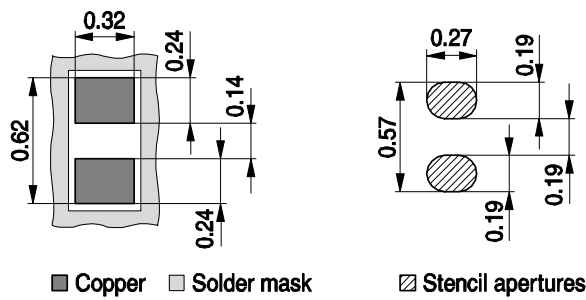

Marking Layout (Example)

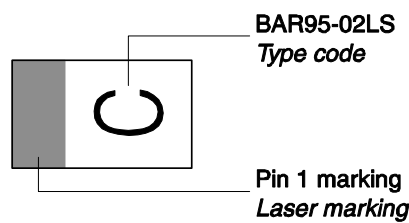

Standard Packing

Reel \varnothing 180 mm = 15.000 Pieces/Reel

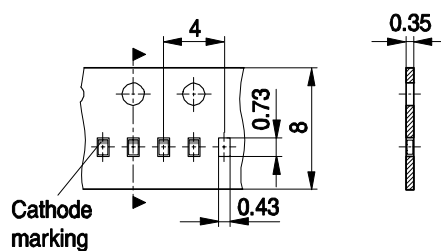

Edition 2009-11-16

**Published by
Infineon Technologies AG
81726 Munich, Germany**

**© 2009 Infineon Technologies AG
All Rights Reserved.**

Legal Disclaimer

The information given in this document shall in no event be regarded as a guarantee of conditions or characteristics. With respect to any examples or hints given herein, any typical values stated herein and/or any information regarding the application of the device, Infineon Technologies hereby disclaims any and all warranties and liabilities of any kind, including without limitation, warranties of non-infringement of intellectual property rights of any third party.

Information

For further information on technology, delivery terms and conditions and prices, please contact the nearest Infineon Technologies Office (www.infineon.com).



Warnings

Due to technical requirements, components may contain dangerous substances. For information on the types in question, please contact the nearest Infineon Technologies Office.

Infineon Technologies components may be used in life-support devices or systems only with the express written approval of Infineon Technologies, if a failure of such components can reasonably be expected to cause the failure of that life-support device or system or to affect the safety or effectiveness of that device or system. Life support devices or systems are intended to be implanted in the human body or to support and/or maintain and sustain and/or protect human life. If they fail, it is reasonable to assume that the health of the user or other persons may be endangered.

Looking for pricing, stock, or lifecycle information?

Click below to explore more details on WIN SOURCE:

-  [View ESD8V0R1B-02LRH E6433 on WIN SOURCE](#)
-  [Infineon Technologies Information](#)

Optimize Your Supply Chain with WIN SOURCE Solutions

-  Global Sourcing Solution
-  Obsolete Management
-  Cost Control Management
-  Shortage Management
-  Alternative Solution
-  Excess Inventory Management