



THE DATASHEET OF HER603-T



Features

- High Surge Current Capability
- Low Leakage and Forward Voltage Drop
- Plastic Material - UL Flammability Classification 94V-0
- Low Power Loss, High Efficiency

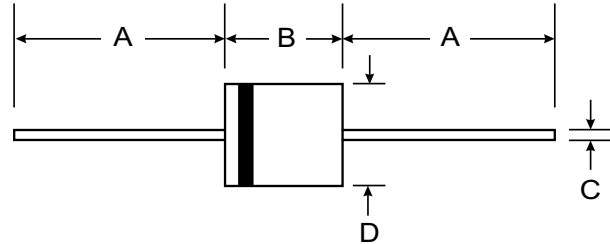

Mechanical Data

- Case: Molded Plastic
- Terminals: Axial Leads, Solderable per MIL-STD-202, Method 208
- Polarity: Color Band Indicates Cathode
- Approx. Weight: 1.7 grams
- Mounting Position: Any

| R-6 | | |
|----------------------|------|-----|
| Dim | Min | Max |
| A | 25.4 | — |
| B | 8.6 | 9.1 |
| C | 1.2 | 1.3 |
| All Dimensions in mm | | |

Maximum Ratings and Electrical Characteristics

Ratings at 25° C ambient temperature unless otherwise specified.
Single phase, half wave, 60Hz, resistive or inductive load.

| Characteristic | Symbol | HER601 | HER602 | HER603 | HER604 | Units |
|--|-----------------|-------------|--------|--------|--------|------------------|
| Maximum Recurrent Peak Reverse Voltage | V_{RRM} | 50 | 100 | 200 | 300 | V |
| Maximum RMS Voltage | V_{RSM} | 35 | 70 | 140 | 210 | V |
| Maximum dc Blocking Voltage | V_{DC} | 50 | 100 | 200 | 300 | V |
| Maximum Average Forward Rectified Current (Fig. 1) | $I_{(AV)}$ | 6.0 | | | | A |
| Peak Forward Surge Current, 8.3ms single half sine-wave superimposed on rated load (JEDEC Method) | I_{FSM} | 250 | | | | A |
| Maximum Instantaneous Forward Voltage at 6.0A dc | V_F | 1.2 | | | | V |
| Maximum dc Reverse Current at Rated dc Blocking Voltage $T_A = 25^\circ\text{C}$ | I_R | 10 | | | | μA |
| Maximum Reverse Recovery Time (Note 1) | T_{RR} | 60 | | | | ns |
| Maximum Full Load Reverse Current Full Cycle Average 9.5mm lead length at $T_C = 55^\circ\text{C}$ | I_R | 150 | | | | μA |
| Typical Junction Capacitance (Note 2) | $R_{\theta JA}$ | 100 | | | | pF |
| Operating and Storage Temperature Range | T_J, T_{STG} | -65 to +150 | | | | $^\circ\text{C}$ |

- Notes: 1. Reverse Recovery Test Conditions: $I_F = 0.5\text{ A}$, $I_R = 1.0\text{ A}$, $I_{RR} = 0.25\text{ A}$
2. Measured at 1.0 MHz and applied reverse voltage of 4.0 volts.

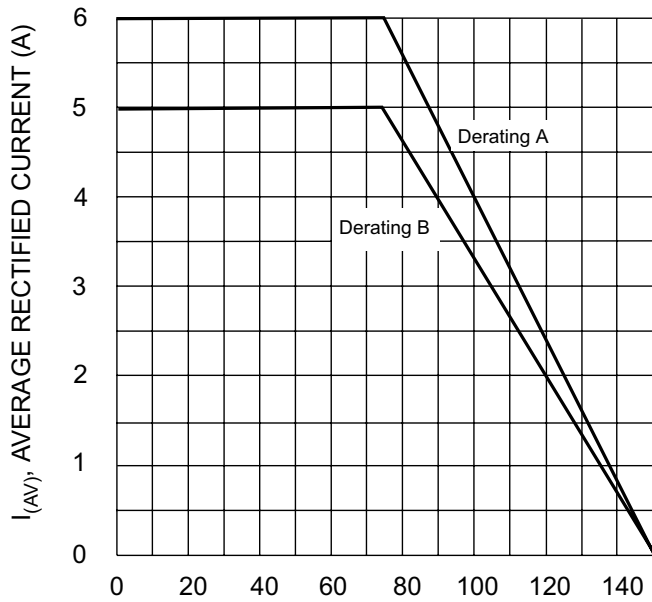

T_A , AMBIENT TEMPERATURE ($^{\circ}C$)
Fig. 1, Forward Current Derating Curve

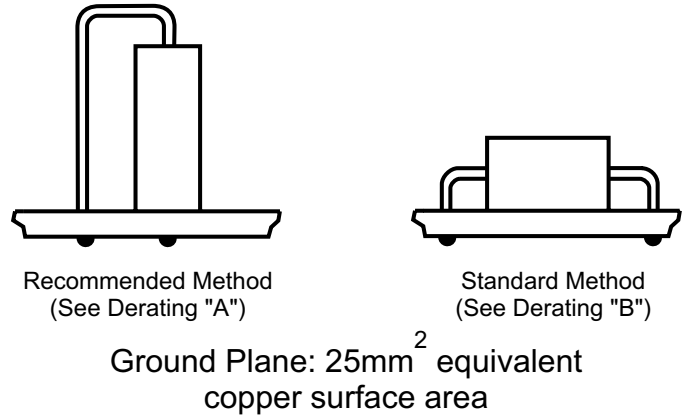

Fig. 2, Printed Circuit Board Mounting Method

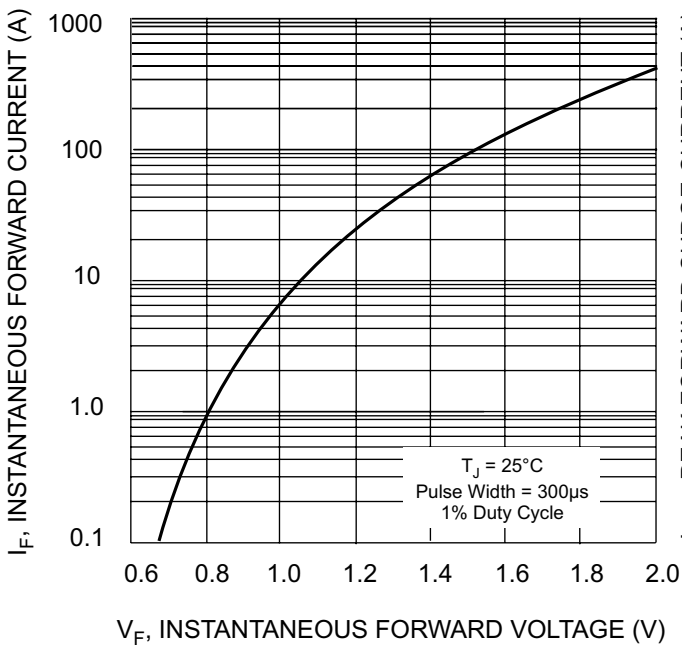

Fig. 3, Typical Forward Characteristics

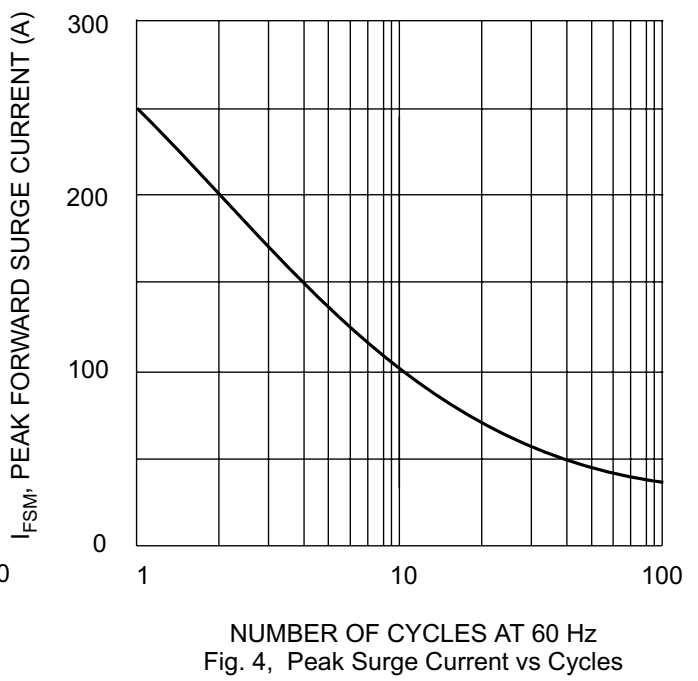



Fig. 4, Peak Surge Current vs Cycles

Looking for pricing, stock, or lifecycle information?

Click below to explore more details on WIN SOURCE:

-  [View HER603-T on WIN SOURCE](#)
-  [Diodes Incorporated Information](#)

Optimize Your Supply Chain with WIN SOURCE Solutions

-  Global Sourcing Solution
-  Obsolete Management
-  Cost Control Management
-  Shortage Management
-  Alternative Solution
-  Excess Inventory Management