



**THE DATASHEET OF
SLVU2.8Q.TCT**



PROTECTION PRODUCTS

Description

The SLVU2.8Q transient voltage suppressor is rated to Grade 3 of AEC-Q100 for use in automotive applications. It is specifically designed to protect sensitive components which are connected to data and transmission lines from overvoltage events. It may be used to protect one single ended line operating up to 2.8 Volts.

The SLVU2.8Q is constructed using Semtech's proprietary EPD process technology. The EPD process provides a true low operating voltage of 2.8 Volts for maximum circuit protection. The SLVU2.8Q features high ESD capability (+/-25kV contact, +/-30kV air per IEC 61000-4-2), low clamping voltage, and is rated to absorb up to 24A for an 8/20us duration pulse. Since the SLVU2.8Q is constructed using solid-state silicon-avalanche technology, it will not degrade as long as it is operated within data sheet parameters.

The SLVU2.8Q is in a 3-lead SOT23 package. The leads are finished with matte tin. This device is a Pb-Free, Halogen Free, RoHS/WEEE compliant product.

Features

- ◆ 400 Watts peak pulse power ($t_p = 8/20\mu s$)
- ◆ Transient protection for high speed data lines to **IEC 61000-4-2 (ESD) $\pm 30kV$ (air), $\pm 25kV$ (contact)**
IEC 61000-4-4 (EFT) 40A (5/50ns)
IEC 61000-4-5 (Lightning) 24A (8/20 μs)
- ◆ One device protects one unidirectional line
- ◆ Qualified to AEC-Q100, Grade 3
- ◆ Low leakage current
- ◆ Low operating and clamping voltages
- ◆ Solid-state silicon-avalanche technology

Mechanical Characteristics

- ◆ JEDEC SOT-23 3L package
- ◆ Pb-Free, Halogen Free, RoHS/WEEE Compliant
- ◆ Molding compound flammability rating: UL 94V-0
- ◆ Marking: Marking Code
- ◆ Packaging: Tape and Reel

Applications

- ◆ Analog Video
- ◆ Navigation Systems
- ◆ Touch Panels

Circuit Diagram

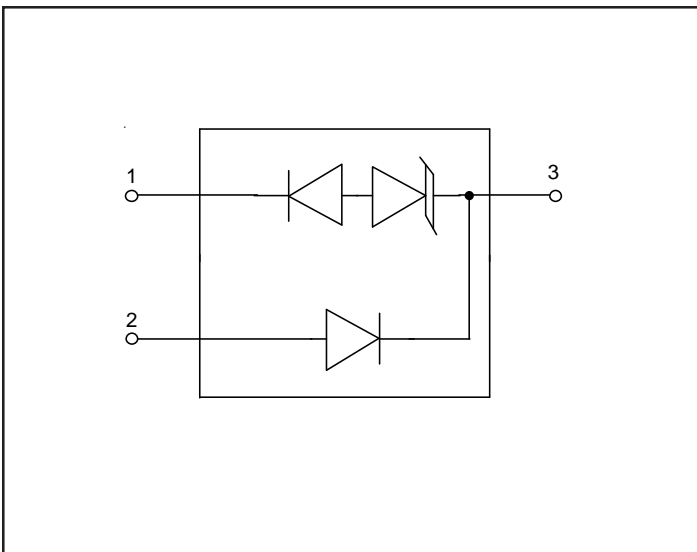

Schematic and PIN Configuration

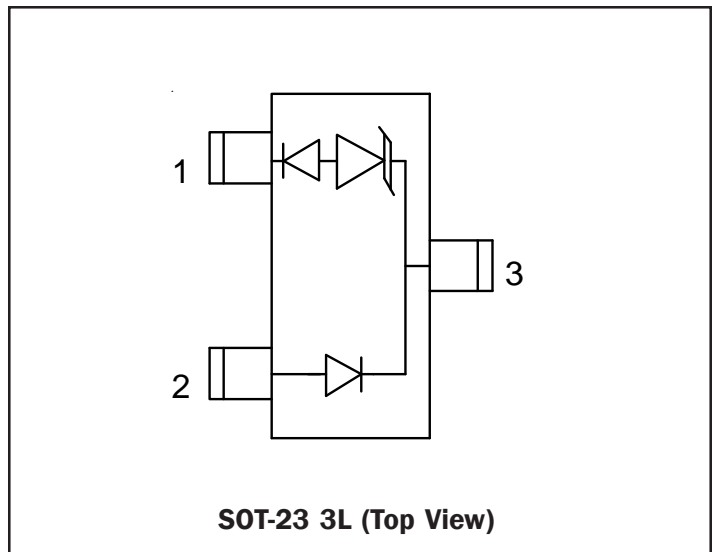

PROTECTION PRODUCTS
Absolute Maximum Rating

Rating	Symbol	Value	Units
Peak Pulse Power (tp = 8/20μs, T=25°C)	P_{pk}	400	Watts
Peak Pulse Current (tp = 8/20μs, T=25°C)	I_{pp}	24	A
ESD per IEC 61000-4-2 (Air) ESD per IEC 61000-4-2 (Contact)	V_{ESD}	+/- 30 +/- 25	KV
Operating Temperature	T_J	-40 to +85	°C
Storage Temperature	T_{STG}	-55 to +125	°C

Electrical Characteristics (T=25°C Unless Otherwise Specified)

Parameter	Symbol	Conditions	Minimum	Typical	Maximum	Units
Reverse Stand-Off Voltage	V_{RWM}	Pin 3 to 1 or Pin 2 to 1 T = -40 to +85°C			2.8	V
Punch-Through Voltage	V_{PT}	$I_{PT} = 2\mu A$, T=25°C Pin 3 to 1	3.2			V
Punch-Through Voltage	V_{PT}	$I_{PT} = 2\mu A$, T=85°C Pin 3 to 1	2.8			V
Snap-Back Voltage	V_{SB}	$I_{SB} = 50mA$, Pin 3 to 1	2.8			V
Reverse Leakage Current	I_R	$V_{RWM} = 2.8V$, T=25°C Pin 3 to 1 or Pin 2 to 1			0.250	μA
Reverse Leakage Current	I_R	$V_{RWM} = 2.8V$, T=85°C Pin 3 to 1 or Pin 2 to 1			0.300	μA
Reverse Leakage Current	I_{RD}	$V_{RWM} = 2.8V$, T=25°C Pin 3 to 2			1	μA
Reverse Leakage Current	I_{RD}	$V_{RWM} = 2.8V$, T=85°C Pin 3 to 2			3	μA
Reverse Breakdown Voltage	V_{BR}	$I_T = 10\mu A$, Pin 3 to 2	100			V

PROTECTION PRODUCTS
Electrical Characteristics (T=25°C Unless Otherwise Specified) - Con't

Parameter	Symbol	Conditions	Minimum	Typical	Maximum	Units
Clamping Voltage	V_C	$I_{PP} = 2A, t_p = 8/20\mu s$ Pin 3 to 1			3.9	V
Clamping Voltage	V_C	$I_{PP} = 5A, t_p = 8/20\mu s$ Pin 3 to 1			7	V
Clamping Voltage	V_C	$I_{PP} = 24A, t_p = 8/20\mu s$ Pin 3 to 1			12.5	V
Clamping Voltage	V_C	$I_{PP} = 5A, t_p = 8/20\mu s$ Pin 2 to 1			8.5	V
Clamping Voltage	V_C	$I_{PP} = 24A, t_p = 8/20\mu s$ Pin 2 to 1			15	V
Junction Capacitance	C_J	Pin 3 to 1 and 2 (Pin 1 and 2 tied together) $V_R = 0V, f = 1MHz$		40	100	pF
Junction Capacitance	C_J	Pin 2 to 1 (pin 3 N.C.) $V_R = 0V, f = 1MHz$		1.5	5	pF

PROTECTION PRODUCTS

Typical Characteristics

Non-Repetitive Peak Pulse Power vs. Pulse Time

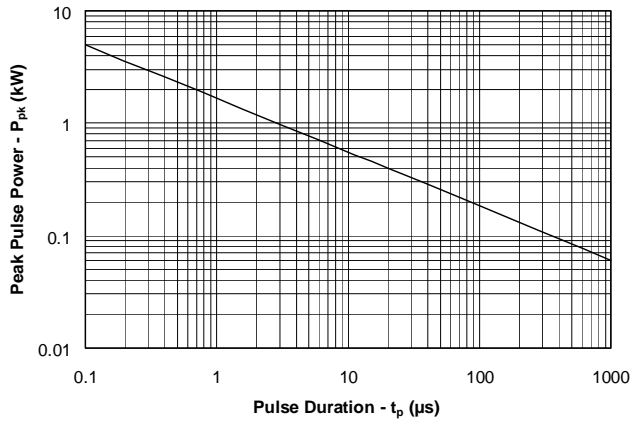

Power Derating Curve

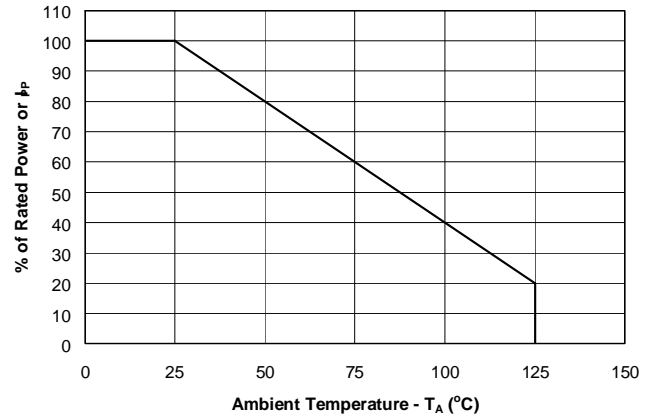

Pulse Waveform

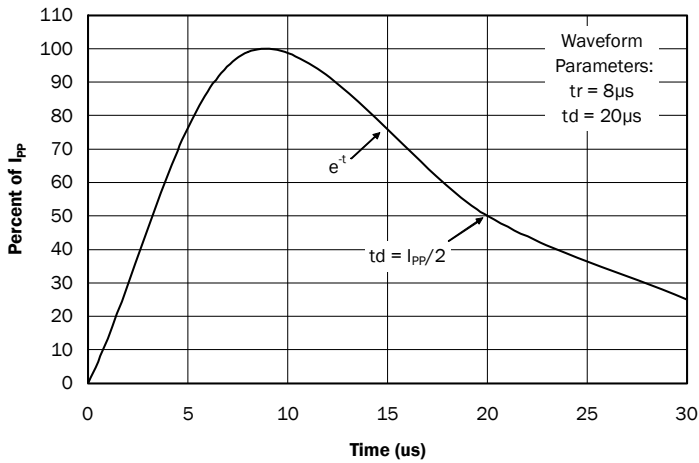

Clamping Voltage vs. Peak Pulse Current (Pin 3 to Pin 1,2)

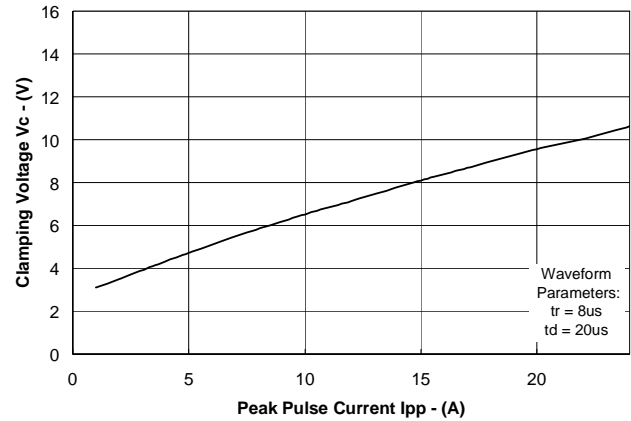

Forward Voltage vs. Forward Current (Pin 2 to Pin 3)

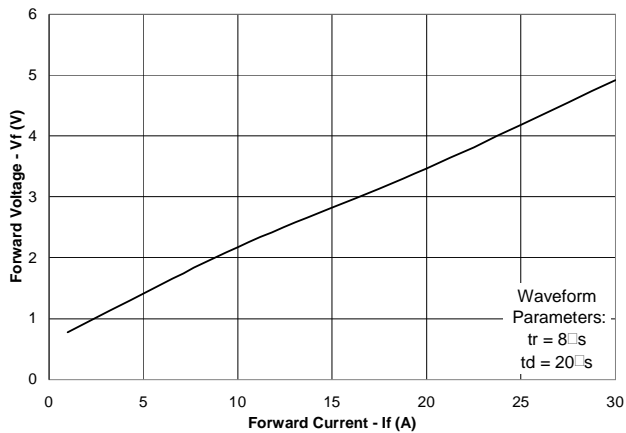

Normalized Capacitance vs. Reverse Voltage (T = 25°C)

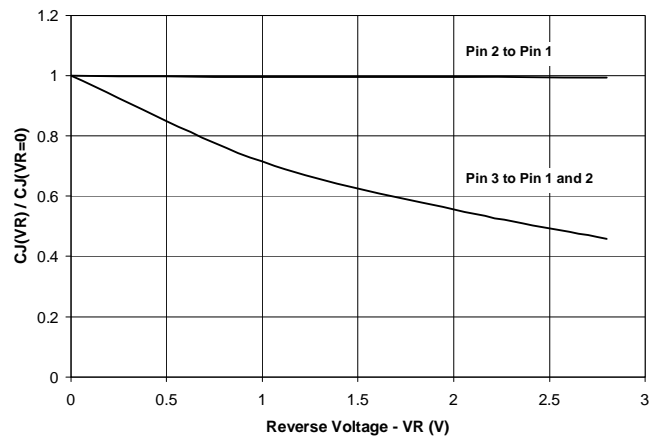

PROTECTION PRODUCTS

Typical Characteristics

Normalized Capacitance vs. Temperature
(Pin 3 to 1, 2)

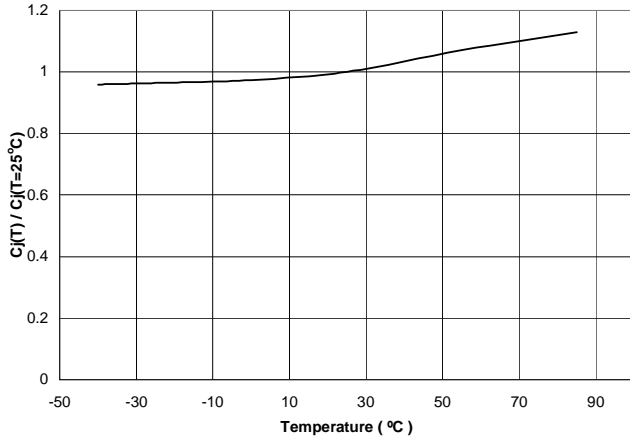

Normalized Capacitance vs. Temperature
(Pin 2 to 1)

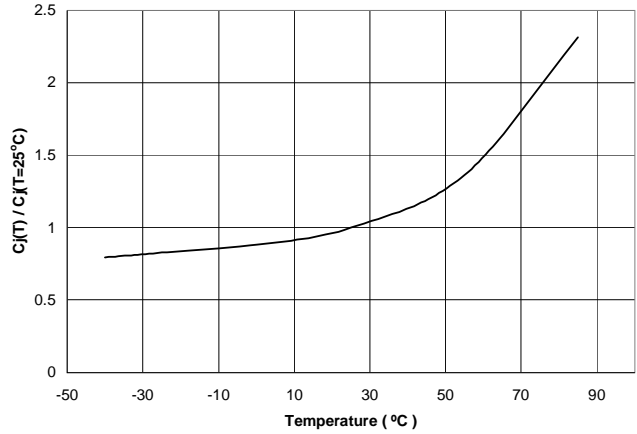

Reverse Leakage Current vs. Temperature
(Pin 3 to 1, 2)

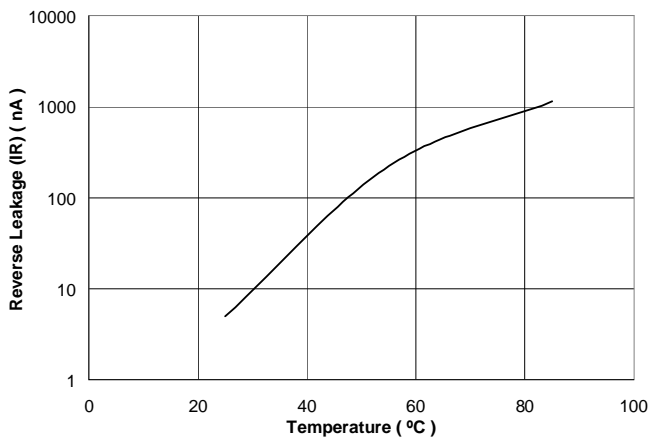

Punch-Through Voltage vs. Temperature
(Pin 3 to 1, 2)

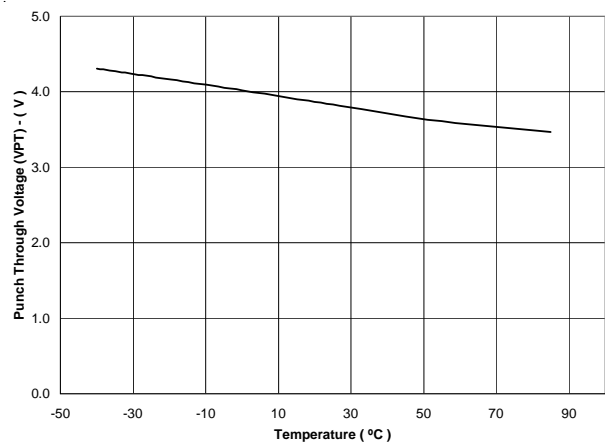

ESD Clamping (Pin 3 to 1, 2)
(8kV Contact per IEC 61000-4-2)

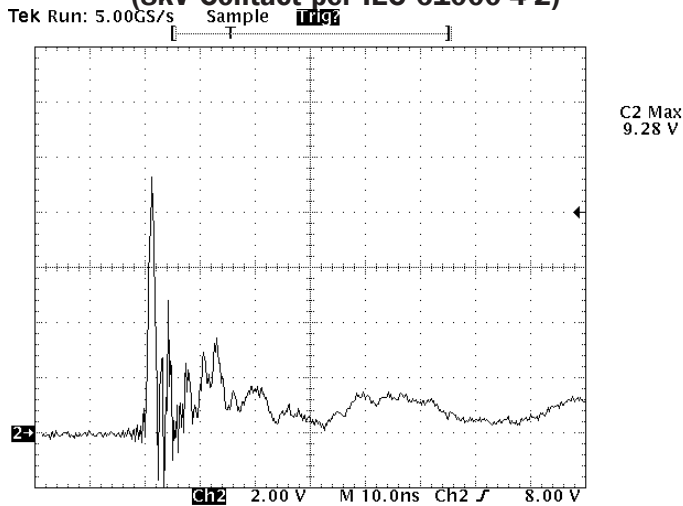

ESD Clamping (Pin 1, 2 to 3)
(-8kV Contact per IEC 61000-4-2)

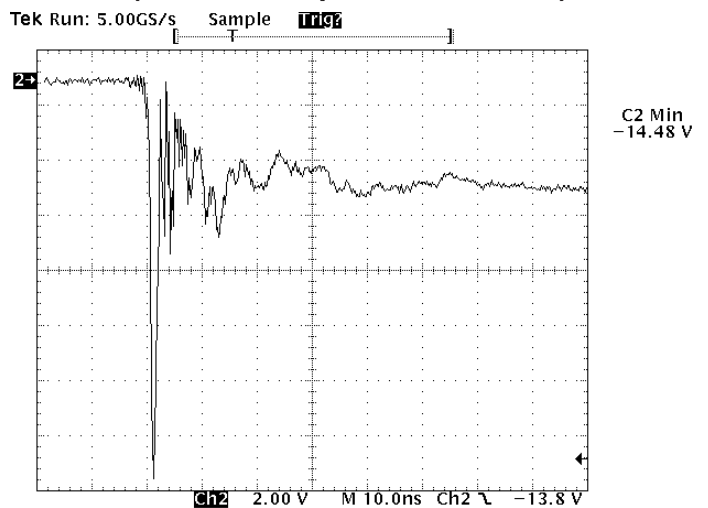

Note: ESD data is taken with a 10x attenuator

PROTECTION PRODUCTS

Applications Information

Device Connection Options

Electronic equipment is susceptible to transient disturbances from a variety of sources including: ESD to an open connector or interface, direct or nearby lightning strikes to cables and wires, and charged cables “hot plugged” into I/O ports. The SLVU2.8Q is designed to protect sensitive components from damage and latch-up which may result from such transient events. The SLVU2.8Q can be configured to protect either one unidirectional line or two (one line pair) high-speed data lines. The options for connecting the devices are as follows:

- 1. Protection of one unidirectional I/O line:** Protection of one data line is achieved by connecting pin 3 to the protected line, and pins 1 and 2 to ground. This connection option will allow the device to operate on lines with positive polarity signal transitions (during normal operation). In this configuration, the device adds a maximum loading capacitance of 100pF. During positive duration transients, the internal TVS diode will be reversed biased and will act in the avalanche mode, conducting the transient current from pin 3 to 1. The transient will be clamped at or below the rated clamping voltage of the device. For negative duration transients, the internal steering diode is forward biased, conducting the transient current from pin 2 to 3. The transient is clamped below the rated forward voltage drop of the diode.
- 2. Low capacitance protection of one differential line pair:** Protection of a high-speed differential line pair is achieved by connecting two devices in anti-parallel. Pin 1 of the first device is connected to line 1 and pin 2 is connected to line 2. Pin 2 of the second device is connected to line 1 and pin 1 is connected to line 2 as shown. Pin 3 must be left open on both devices. During negative duration transients, the first device will conduct from pin 2 to 1. The steering diode conducts in the forward direction while the TVS will avalanche and conduct in the reverse direction. During positive transients, the second device will conduct in the same manner. In this configuration, the total loading capacitance is the sum of the capacitance (between pins 1 and 2) of each device making this configuration suitable for high-speed interfaces.

SLVU2.8Q Circuit Diagram

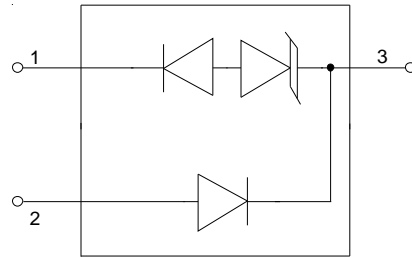

Protection of one unidirectional line

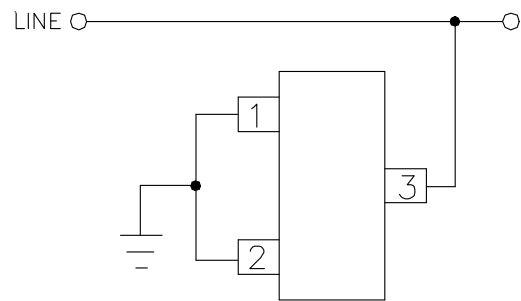

Low capacitance protection of one high-speed line pair

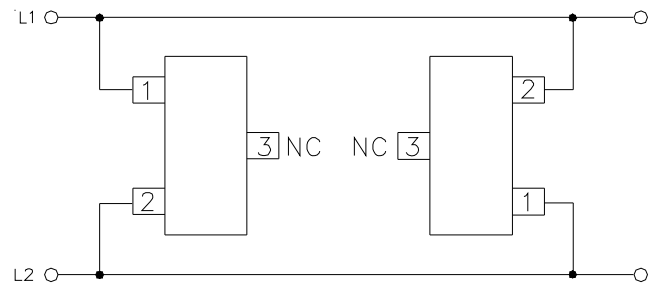

PROTECTION PRODUCTS

Analog Video Input Protection

The SLVU2.8Q can be used in conjunction with a PTC thermistor to protect analog video inputs as shown below. During an overcurrent condition, the PTC will heat up and reduce the current to the load to a low level, protecting downstream components. The reaction time of the PTC depends on several factors that are not very well controlled. This means that protected components can potentially be exposed to damaging overcurrent until there is enough power dissipation to trigger the PTC. The SLVU2.8Q will protect the downstream device until the PTC triggers. The figure at the right shows the typical response of the protection circuit to an overvoltage event. In addition to protecting the circuit until the PTC triggers, the SLVU2.8Q serves to protect components during ESD events. The SLVU2.8Q is capable of withstanding a +/-25kV contact discharge per IEC 61000-4-2.

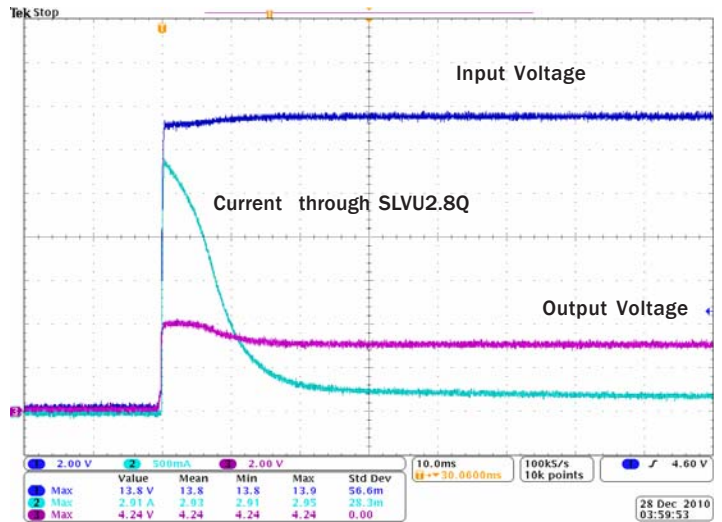

Protection circuit response to an overvoltage event

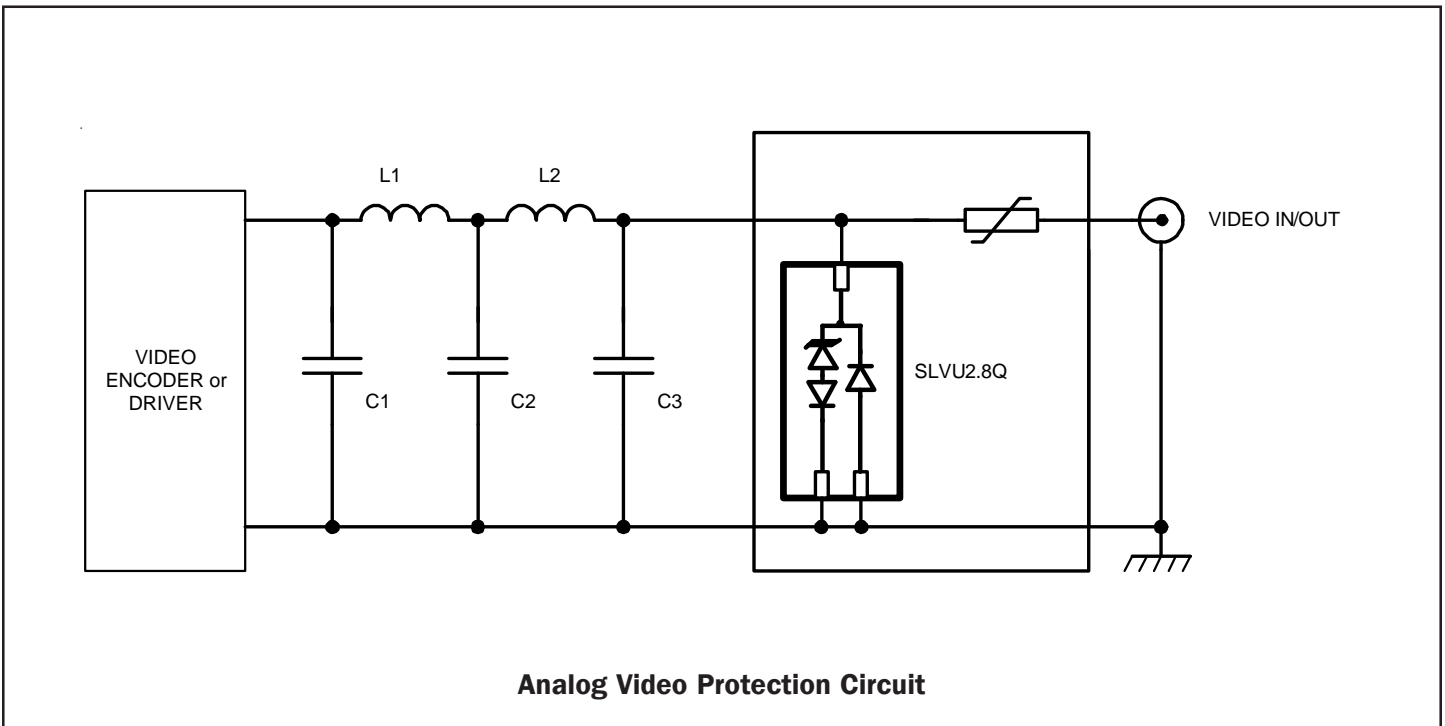

Analog Video Protection Circuit

PROTECTION PRODUCTS

Outline Drawing -SOT23 3L

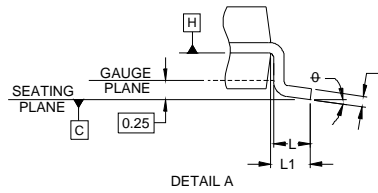
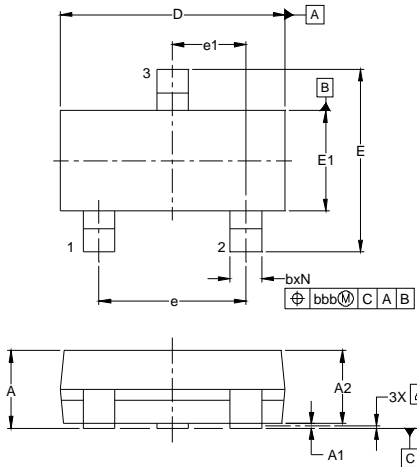

DIM	INCHES			MILLIMETERS		
	MIN	NOM	MAX	MIN	NOM	MAX
A	.035	-	.044	0.89	-	1.12
A1	.000	-	.004	0.01	-	0.10
A2	.035	.037	.040	0.88	0.95	1.02
b	.012	-	.020	0.30	-	0.51
c	.003	-	.007	0.08	-	0.18
D	.110	.114	.120	2.80	2.90	3.04
E	.082	.093	.104	2.10	2.37	2.64
E1	.047	.051	.055	1.20	1.30	1.40
e				1.90 BSC		
e1				0.95 BSC		
L	.015	.020	.024	0.40	0.50	0.60
L1				(0.55)		
N				3		
phi	0°	-	8°	0°	-	8°
aaa				0.10		
bbb				0.20		

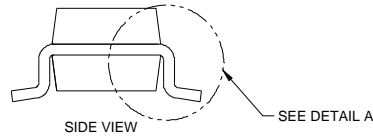

NOTES:

1. CONTROLLING DIMENSIONS ARE IN MILLIMETERS (ANGLES IN DEGREES).
2. DATUMS [-A-] AND [-B-] TO BE DETERMINED AT DATUM PLANE [-H-]
3. DIMENSIONS "E1" AND "D" DO NOT INCLUDE MOLD FLASH, PROTRUSIONS OR GATE BURRS.

Land Pattern -SOT23 3L

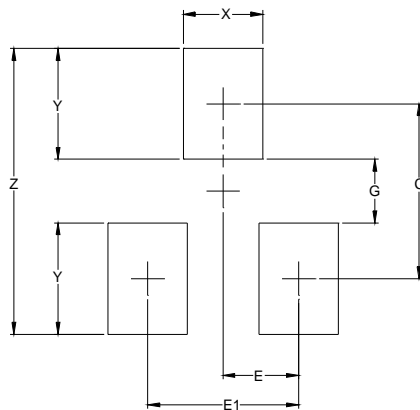

DIMENSIONS		
DIM	INCHES	MILLIMETERS
C	(.087)	(2.20)
E	.037	0.95
E1	.075	1.90
G	.031	0.80
X	.039	1.00
Y	.055	1.40
Z	.141	3.60

NOTES:

1. THIS LAND PATTERN IS FOR REFERENCE PURPOSES ONLY CONSULT YOUR MANUFACTURING GROUP TO ENSURE YOUR COMPANY'S MANUFACTURING GUIDELINES ARE MET.
2. REFERENCE IPC-SM-782A.

PROTECTION PRODUCTS

Marking Codes

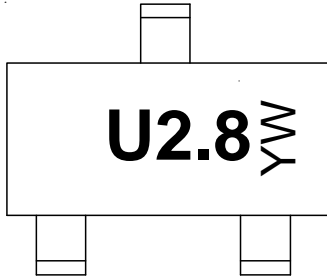

Ordering Information

Part Number	Qty per Reel	Reel Size
SLVU2.8Q.TCT	3,000	7 Inch

YW = 2 - Alphanumeric characters for Date Code

Tape and Reel Specification

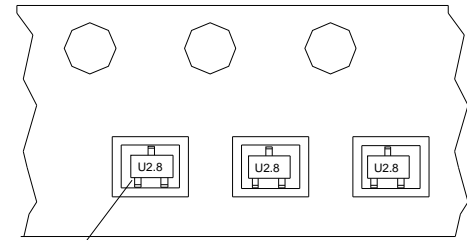
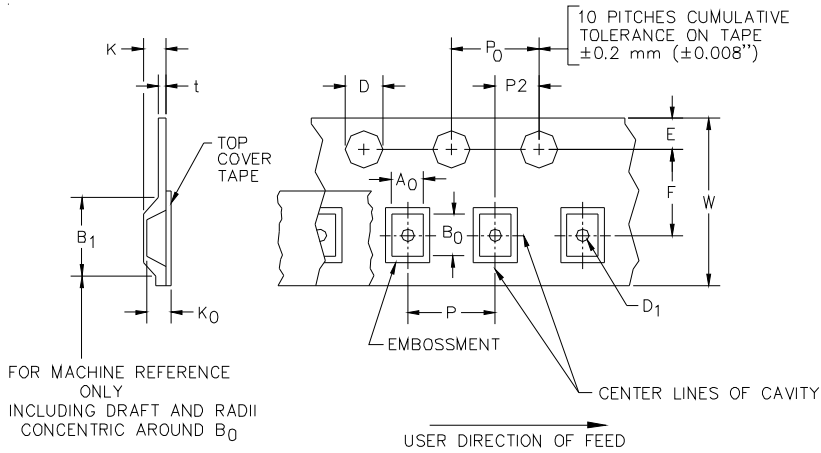

Pin 1 Location

User Direction of feed

A0	B0	K0
3.23 +/-0.05 mm	3.17 +/-0.05 mm	1.37 +/-0.05 mm

Tape Width	B, (Max)	D	D1	E	F	K (MAX)	P	P0	P2	T(MAX)	W
8 mm	4.2 mm (.165)	1.5 + 0.1 mm - 0.0 mm	1.0 mm ±0.05	1.750±.10 mm	3.5±0.05 mm	2.4 mm	4.0±0.1 mm	4.0±0.1 mm	2.0±0.05 mm	0.4 mm	8.0 mm + 0.3 mm - 0.1 mm

Contact Information

Semtech Corporation
 Protection Products Division
 200 Flynn Road, Camarillo, CA 93012
 Phone: (805)498-2111 FAX (805)498-3804

Looking for pricing, stock, or lifecycle information?

Click below to explore more details on WIN SOURCE:

- ⊖ [View SLVU2.8Q.TCT on WIN SOURCE](#)
- ⊖ [Semtech Corporation](#) Information

Optimize Your Supply Chain with WIN SOURCE Solutions

- ✓ Global Sourcing Solution
- ✓ Obsolete Management
- ✓ Cost Control Management
- ✓ Shortage Management
- ✓ Alternative Solution
- ✓ Excess Inventory Management