



THE DATASHEET OF FR607





Technical Data
Data Sheet N0450, Rev. -

Green Products

Features

- Diffused Junction
- Low Forward Voltage Drop
- High Current Capability
- High Reliability
- High Surge Current Capability
- This is a Pb - Free Device
- All SMC parts are traceable to the wafer lot
- Additional testing can be offered upon request

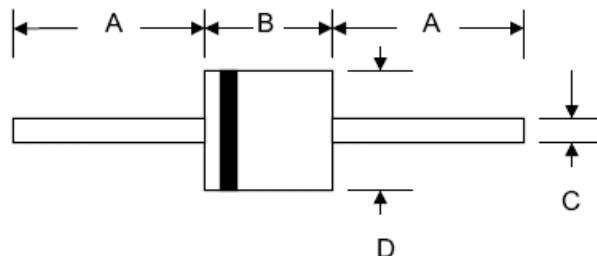

Mechanical Data

- Case: Molded Plastic
- Terminals: Plated Leads Solderable per MIL-STD-202, Method 208
- Polarity: Cathode Band
- Weight: 2.1 grams (approx.)
- Mounting Position: Any
- Marking: Type Number
- Epoxy: UL 94V-O rate flame retardant

R-6				
Dim	Min	Max	Min	Max
A	25.4	—	1.000	—
B	8.60	9.10	0.338	0.358
C	1.20	1.30	0.047	0.051
D	8.60	9.10	0.338	0.358
	In mm		In inch	

Marking Diagram:

Where XXXXX is YYWWL

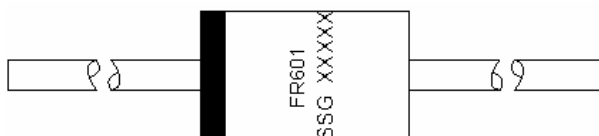

FR601 = Part Name
SSG = SSG
YY = Year
WW = Week
L = Lot Number

Cautions: Molding resin
Epoxy resin UL:94V-0

Ordering Information

Device	Package	Shipping
FR601-FR607	R-6 (Pb-Free)	500pcs / reel

For information on tape and reel specifications, including part orientation and tape sizes, please refer to our Tape and Reel Packaging Specification.



Maximum Ratings and Electrical Characteristics @T_A=25°C unless otherwise specified

Single Phase, half wave, 60Hz, resistive or inductive load.
For capacitive load, derate current by 20%.

Characteristic	Symbol	FR601	FR602	FR603	FR604	FR605	FR606	FR607	Unit
Peak Repetitive Reverse Voltage Working Peak Reverse Voltage DC Blocking Voltage	V _{RRM} V _{RWM} V _R	50	100	200	400	600	800	1000	V
RMS Reverse Voltage	V _{R(RMS)}	35	70	140	280	420	560	700	V
Average Rectified Output Current (Note 1) @T _A = 55°C	I _O	6.0							A
Non-Repetitive Peak Forward Surge Current 8.3ms Single half sine-wave superimposed on rated load (JEDEC Method)	I _{FSM}	200							A
Forward Voltage @I _F = 6.0A	V _{FM}	1.2							V
Peak Reverse Current @T _A = 25°C At Rated DC Blocking Voltage @T _A = 100°C	I _{RM}	10 200							μA
Reverse Recovery Time (Note 2)	t _{rr}	150				250	500		nS
Typical Junction Capacitance (Note 3)	C _j	100							pF
Operating Temperature Range	T _j	-65 to +125							°C
Storage Temperature Range	T _{STG}	-65 to +150							°C

***Glass passivated forms are available upon request**

Note: 1. Leads maintained at ambient temperature at a distance of 9.5mm from the case

2. Measured with I_F = 0.5A, I_R = 1.0A, I_{RR} = 0.25A. See figure 5.

3. Measured at 1.0 MHz and applied reverse voltage of 4.0V D.C.



Technical Data
Data Sheet N0450, Rev. -

Green Products

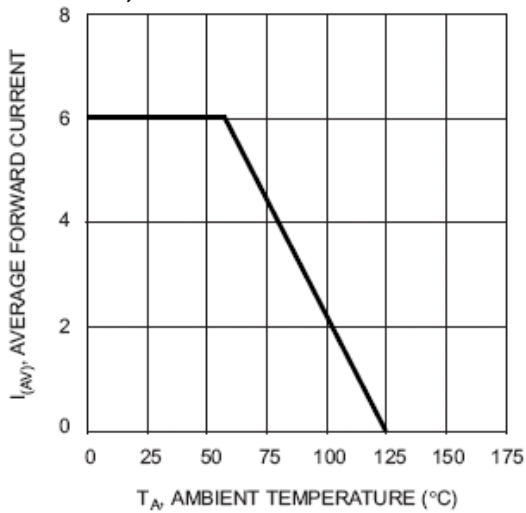

Fig. 1, Typical Forward Current Derating Curve

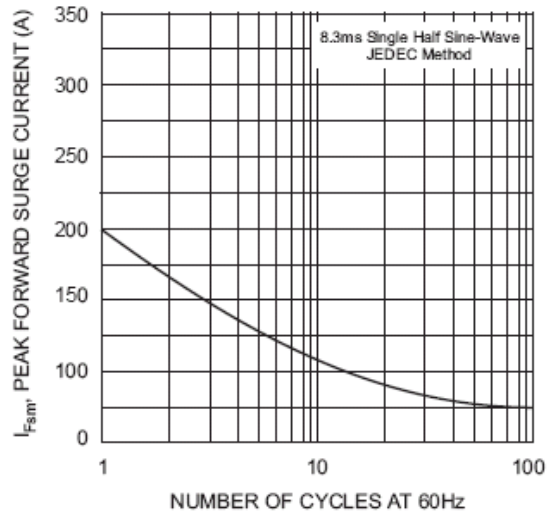

Fig. 2 Max Non-Repetitive Peak Surge Current

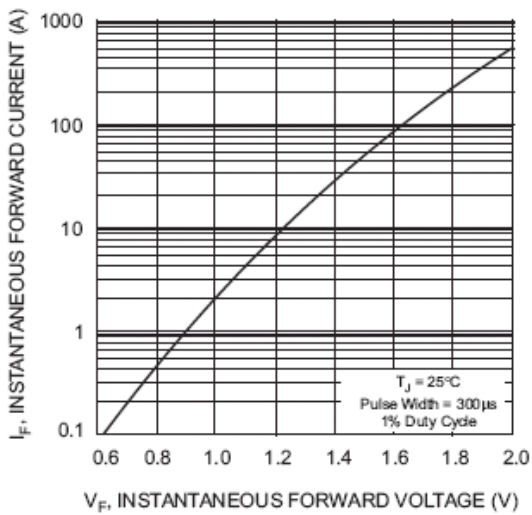

Fig. 3, Typical Instantaneous Forward Characteristics

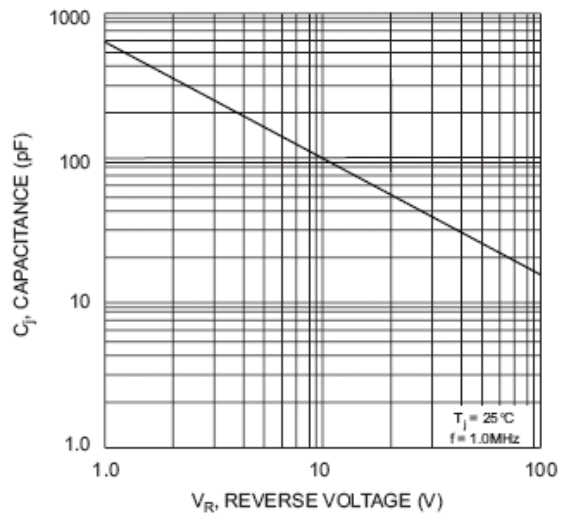
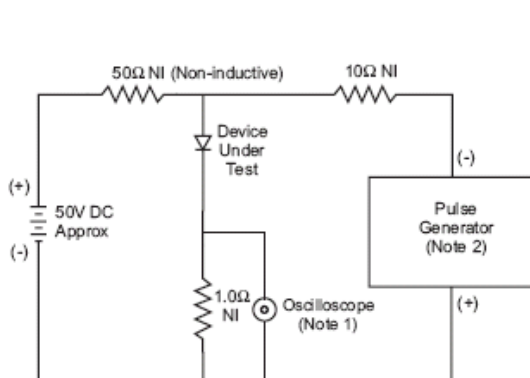

Fig. 4 Typical Junction Capacitance



Notes:
1. Rise Time = 7.0ns max. Input Impedance = 1.0MΩ, 22pF.
2. Rise Time = 10ns max. Input Impedance = 50Ω.

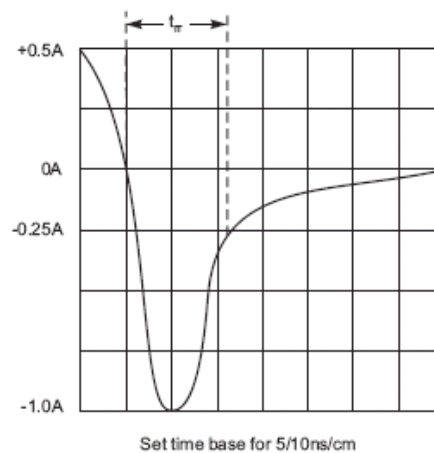

Fig. 5 Reverse Recovery Time Characteristic and Test Circuit





DISCLAIMER:

- 1- The information given herein, including the specifications and dimensions, is subject to change without prior notice to improve product characteristics. Before ordering, purchasers are advised to contact the SMC - Sangdest Microelectronics (Nanjing) Co., Ltd sales department for the latest version of the datasheet(s).
- 2- In cases where extremely high reliability is required (such as use in nuclear power control, aerospace and aviation, traffic equipment, medical equipment, and safety equipment), safety should be ensured by using semiconductor devices that feature assured safety or by means of users' fail-safe precautions or other arrangement.
- 3- In no event shall SMC - Sangdest Microelectronics (Nanjing) Co., Ltd be liable for any damages that may result from an accident or any other cause during operation of the user's units according to the datasheet(s). SMC - Sangdest Microelectronics (Nanjing) Co., Ltd assumes no responsibility for any intellectual property claims or any other problems that may result from applications of information, products or circuits described in the datasheets.
- 4- In no event shall SMC - Sangdest Microelectronics (Nanjing) Co., Ltd be liable for any failure in a semiconductor device or any secondary damage resulting from use at a value exceeding the absolute maximum rating.
- 5- No license is granted by the datasheet(s) under any patents or other rights of any third party or SMC - Sangdest Microelectronics (Nanjing) Co., Ltd.
- 6- The datasheet(s) may not be reproduced or duplicated, in any form, in whole or part, without the expressed written permission of SMC - Sangdest Microelectronics (Nanjing) Co., Ltd.
- 7- The products (technologies) described in the datasheet(s) are not to be provided to any party whose purpose in their application will hinder maintenance of international peace and safety nor are they to be applied to that purpose by their direct purchasers or any third party. When exporting these products (technologies), the necessary procedures are to be taken in accordance with related laws and regulations..

Looking for pricing, stock, or lifecycle information?

Click below to explore more details on WIN SOURCE:

-  [View FR607 on WIN SOURCE](#)
-  [SMC Diode Solutions Information](#)

Optimize Your Supply Chain with WIN SOURCE Solutions

-  Global Sourcing Solution
-  Obsolete Management
-  Cost Control Management
-  Shortage Management
-  Alternative Solution
-  Excess Inventory Management