



THE DATASHEET OF B6S-G



B05S-G Thru. B10S-G

Reverse Voltage: 50 to 1000 Volts

Forward Current: 0.8 A

RoHS Device

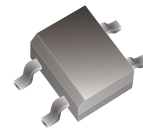

Features

- Rating to 1000V PRV.
- Ideal for printed circuit board.
- Reliable low cost construction utilizing molded plastic technique results in inexpensive product.
- Pb free product.
- UL recognized file # E349301

Mechanical data

- Polarity: Symbol molded on body.
- Weight: 0.125 grams.
- Mounting position: Any.

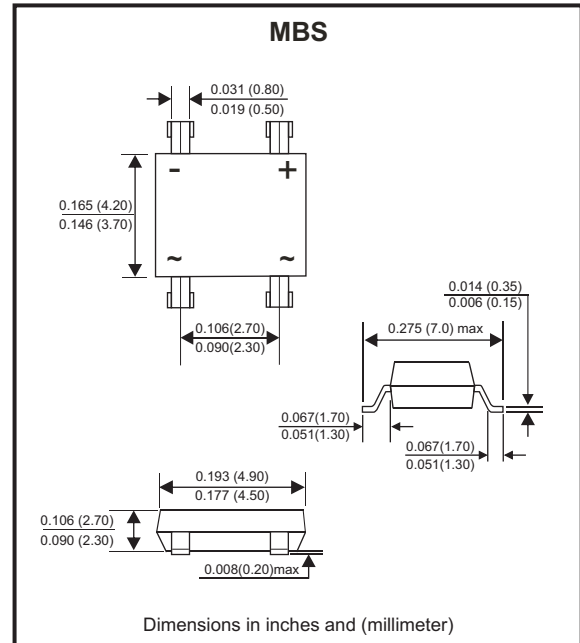

Maximum Rating And Electrical Characteristics

Rating at $T_A=25^{\circ}\text{C}$, unless otherwise noted.
 Single phase, half wave, 60Hz, resistive or inductive load.
 For capacitive load, derate current by 20%.

Parameter	Symbol	B05S-G	B1S-G	B2S-G	B4S-G	B6S-G	B8S-G	B10S-G	Unit
Maximum Recurrent Peak Reverse Voltage	V_{RRM}	50	100	200	400	600	800	1000	V
Maximum RMS Voltage	V_{RMS}	35	70	140	280	420	560	700	V
Maximum DC Blocking Voltage	V_{DC}	50	100	200	400	600	800	1000	V
Maximum Average Forward Rectified Current (Note 1) @ $T_A=40^{\circ}\text{C}$	$I_{(AV)}$	0.8							A
Peak Forward Surge Current, 8.3ms single half sine-wave, superimposed on rated load (JEDEC Method)	I_{FSM}	30							A
Peak Forward Voltage at 0.8A DC	V_F	1.1							V
Maximum DC Reverse Current at Rated DC Blocking Voltage @ $T_J=25^{\circ}\text{C}$ @ $T_J=125^{\circ}\text{C}$	I_R	5.0 500							μA
Typical Junction Capacitance per element (Note 2)	C_J	15							pF
Typical Thermal Resistance	Junction to ambient	$R_{\theta JA}$							$^{\circ}\text{C/W}$
	Junction to case	$R_{\theta JC}$							
Operating Temperature Range	T_J	-55 to +150							$^{\circ}\text{C}$
Storage Temperature Range	T_{STG}	-55 to +150							$^{\circ}\text{C}$

Notes: 1. Mounted on P.C. Board.
 2. Measured at 1.0MHz and applied reverse voltage of 4V DC.

Company reserves the right to improve product design, functions and reliability without notice.

REV:E

RATING AND CHARACTERISTIC CURVES (B05S-G thru. B10S-G)

Fig.1 - Forward Current Derating Curve

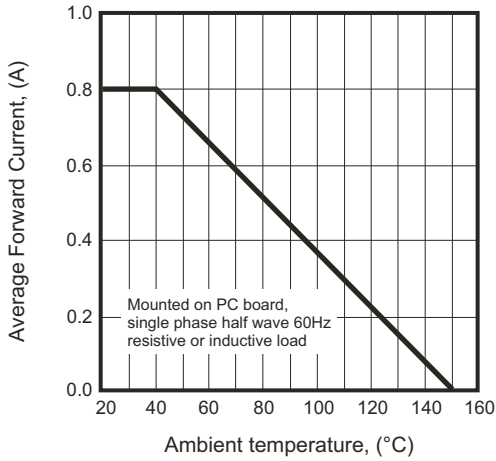

Fig.2 - Maximum Non-Repetitive Surge Current

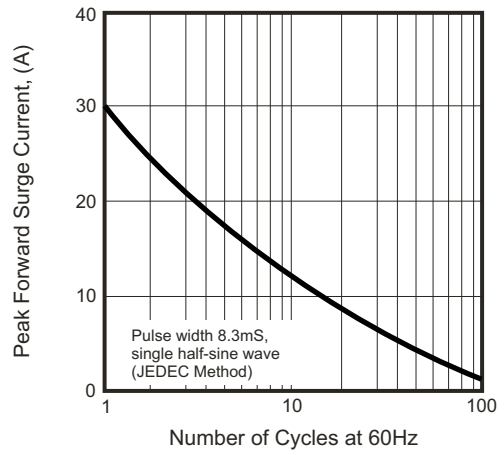

Fig.3 - Typical Reverse Characteristics

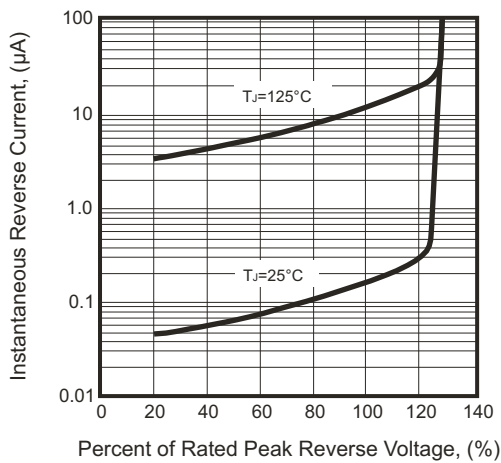

Fig.4 - Typical Forward Characteristics

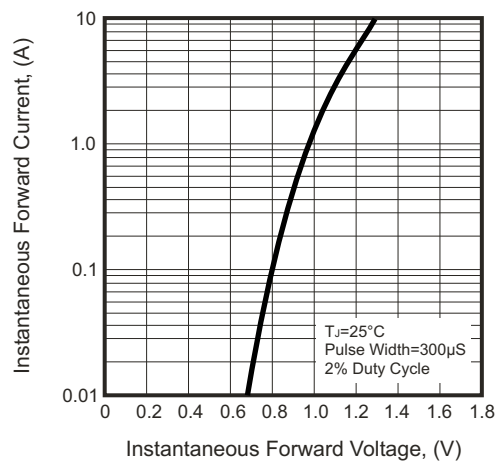
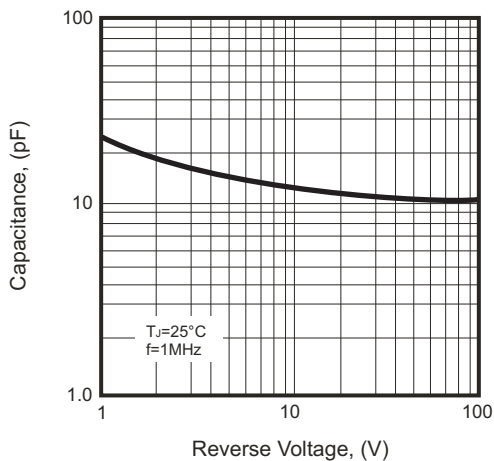
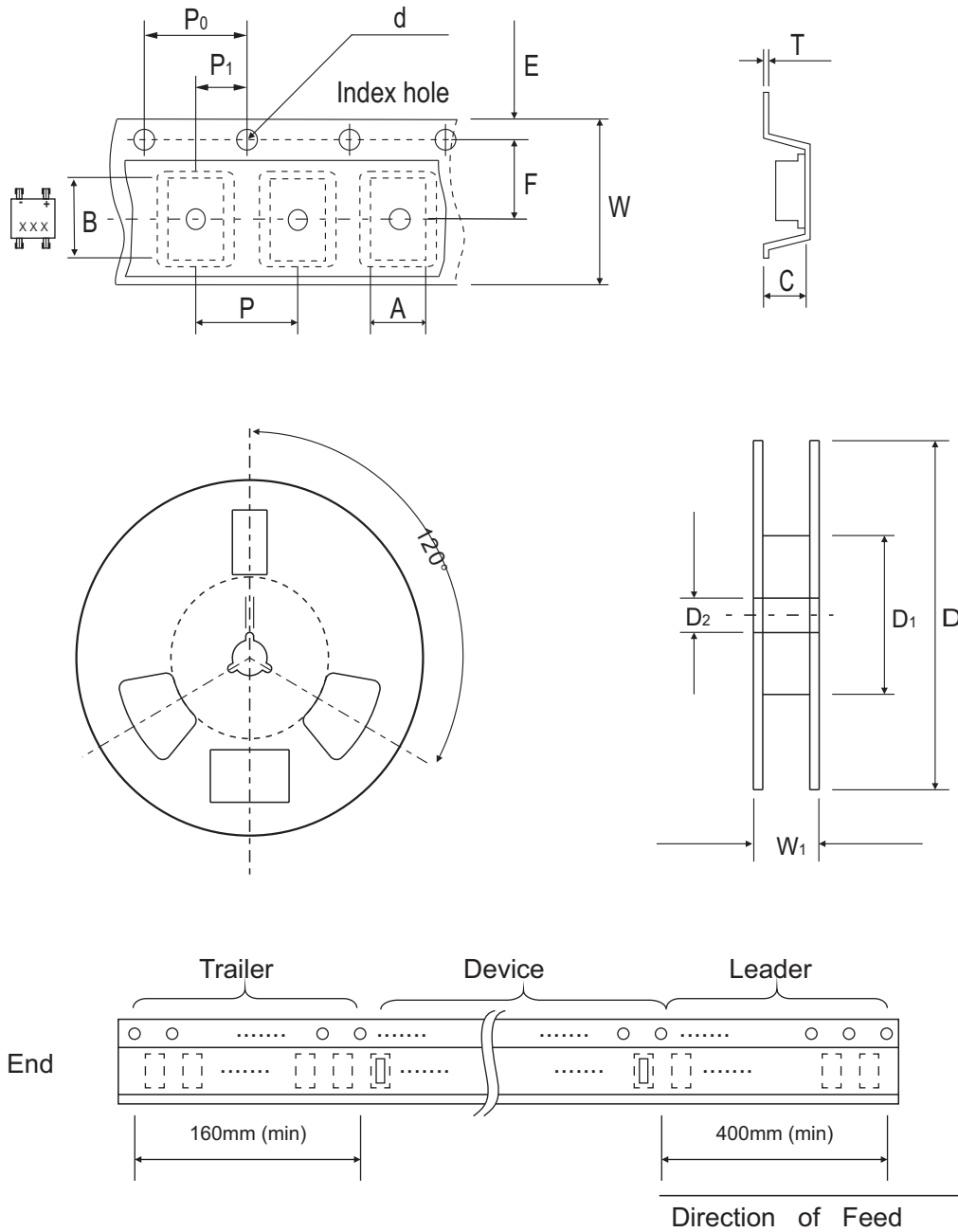

Fig.5 - Typical Junction Capacitance



Company reserves the right to improve product design, functions and reliability without notice.

Reel Taping Specification



MBS	SYMBOL	A	B	C	d	D	D1	D2
	(mm)	4.90 ± 0.10	7.24 ± 0.10	3.33 ± 0.10	1.55 ± 0.05	330	50.0 MIN.	13.00 ± 0.20
	(inch)	0.193 ± 0.004	0.285 ± 0.004	0.131 ± 0.004	0.061 ± 0.002	13	1.969 MIN.	0.512 ± 0.008

MBS	SYMBOL	E	F	P	P0	P1	T	W	W1
	(mm)	1.75 ± 0.10	5.50 ± 0.05	8.00 ± 0.10	4.00 ± 0.10	2.00 ± 0.05	0.30	12.00 ± 0.30	12.00~14.40
	(inch)	0.069 ± 0.004	0.217 ± 0.002	0.315 ± 0.004	0.157 ± 0.004	0.079 ± 0.002	0.012	0.472 ± 0.012	0.472~0.657

Company reserves the right to improve product design , functions and reliability without notice.

REV:E

Marking Code

Part Number	Marking code
B05S-G	B05S
B1S-G	B1S
B2S-G	B2S
B4S-G	B4S
B6S-G	B6S
B8S-G	B8S
B10S-G	B10S

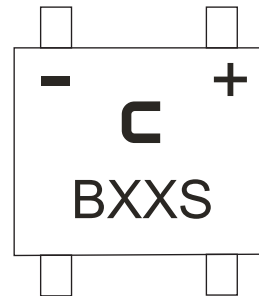

X/XX = Product type marking code

Suggested PAD Layout

SIZE	MBS	
	(mm)	(inch)
A	0.82MIN	0.032MIN
B	2.55REF	0.100REF
C	0.92MIN	0.036MIN
D	7.00MAX	0.276MAX

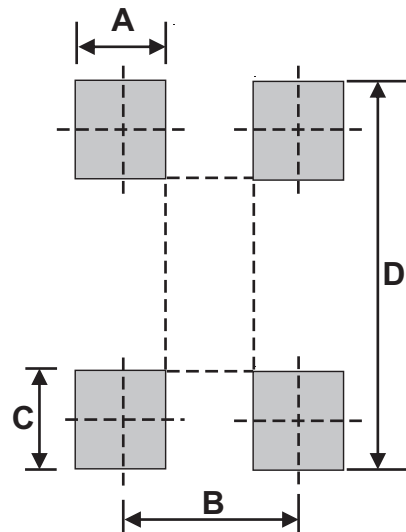

Standard Packaging

Case Type	REEL PACK	
	REEL (pcs)	Reel Size (inch)
MBS	3,000	13

Looking for pricing, stock, or lifecycle information?

Click below to explore more details on WIN SOURCE:

- [View B6S-G on WIN SOURCE](#)
- [Comchip Technology Information](#)

Optimize Your Supply Chain with WIN SOURCE Solutions

- ✓ Global Sourcing Solution
- ✓ Obsolete Management
- ✓ Cost Control Management
- ✓ Shortage Management
- ✓ Alternative Solution
- ✓ Excess Inventory Management