



**THE DATASHEET OF  
UPG1-5657-1**



# AIRPAX®

APG/UPG/IPG Series  
"Existing Designs Only"

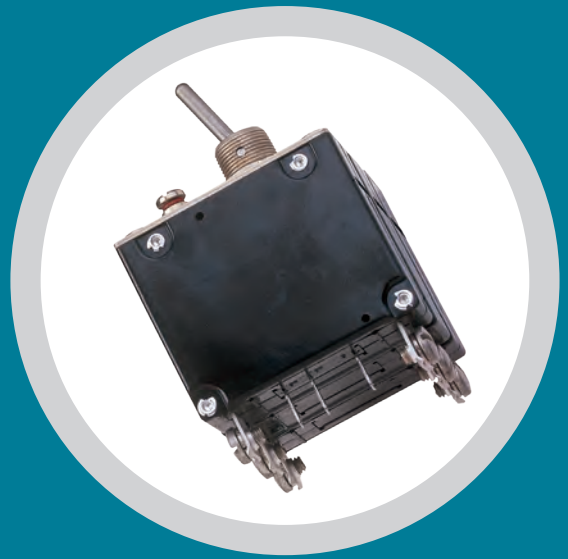
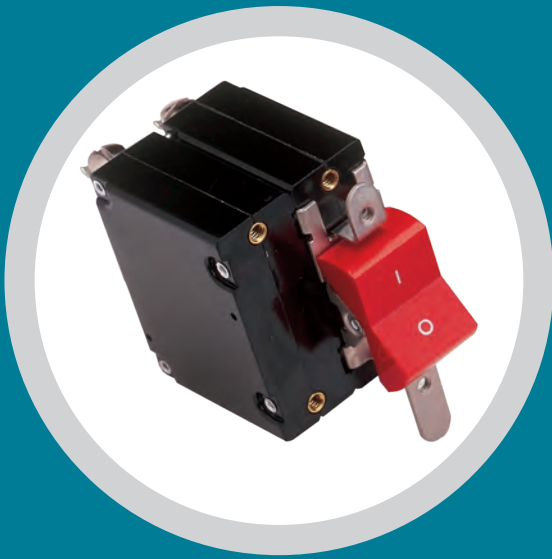



## AIRPAX® | APG/UPG/IPG Series

### Hydraulic Magnetic Circuit Protectors

#### INTRODUCTION

**IMPORTANT NOTICE:** *The APG/UPG is a legacy product and no new design-in orders are being accepted. If the specifications for this product are necessary for your system, Sensata Technologies recommends utilizing the Airpax™ IAG series.*

The APG/UPG magnetic circuit protector provides low-cost power switching, reliable circuit protection and accurate circuit control in one complete package. It is intended for use in data processing and broadcast equipment, vending and amusement machines, military and marine applications, and wherever precision operation is required.

Designed using a current sensitive hydraulic magnetic principle, the APG/UPG adapts itself to many applications and environments. Temperature compensations which affect fuses and other thermal devices are not a concern. Nuisance tripping is minimized.

The APG/UPG is available in a wide variety of configurations with a choice of delays and ratings. In addition, it is available in either DC, 50/60Hz or 400Hz versions.

Available in single or multi-pole variations, the APG/UPG comes with a variety of actuators. To enhance front-panel aesthetics, toggle or rocker actuated handles and caps are available in a variety of attractive colors.

Multi-pole circuit protectors can be furnished with either single or multiple actuators. In addition, a unique sealed, single handle toggle version for harsh or military environments is available in single or multi-pole configurations.

The UPG circuit protector is recognized under UL Standard 1077, file numbers E66410 and E33504 as a supplementary protector. It is also certified by CSA under CSA STD. C22.2–No. 235, file number LR26229 as a supplementary protector. The APG is qualified to MIL-PRF-55629.

APG/UPG circuit protectors are available in one through four pole assemblies with a variety of pole arrangements, terminal styles, and accessories to meet your specifications, including APG/UPG adapter plate option to allow mounting in APL/UPL cutout.

## APG/UPG SINGLE POLE CIRCUIT PROTECTORS

Single Pole, Toggle

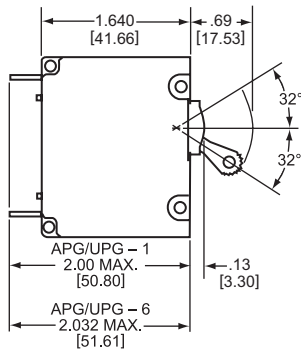

### MAIN TERMINAL TYPES

| Amp Rating | Push-On | 8-32 Screw | M4 Screw | 10-32 Screw | M5 Screw |
|------------|---------|------------|----------|-------------|----------|
| .1 to 30   | X       | X          | X        |             |          |
| 30.1 to 50 |         |            |          | X           | X        |

Single Pole

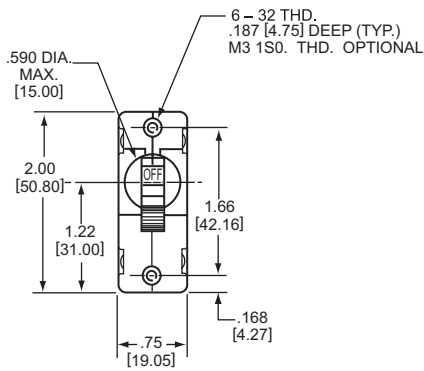

APG 6-1\*

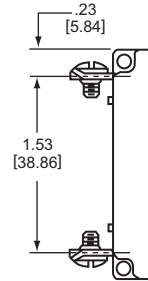

Single Pole, Mounting Detail

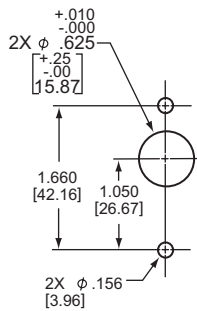

Notes: Tolerance  $\pm$ .015 [.38] unless noted.  
Dimensions in Brackets [ ] are millimeters.  
\* \* Allows mounting in APL/UPL cutout.

## TWO POLE PROTECTORS

An assembly consisting of two single pole units, having their trip mechanisms internally coupled, and with a single toggle handle, forms the APG/UPG-11. It is also possible to provide a handle per pole, which is referred to as UPGH11. Individual poles may differ in ratings, delays and internal connections. An auxiliary switch may be included in either or both poles if they are of the series trip type. Screw-type terminals can be provided, in which case the designation would be APG/UPG-66.

Two Pole

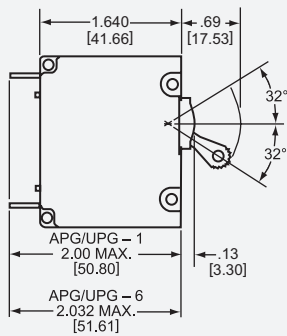

UPG11

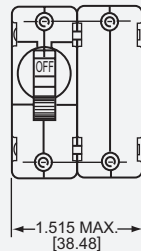

(Optional, handle may be in pole 1 instead of pole 2)

UPGH11

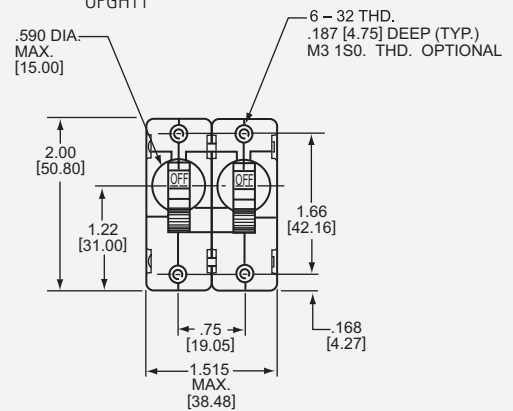

UPG11

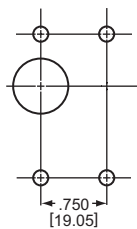

Two Pole\*

UPGH11

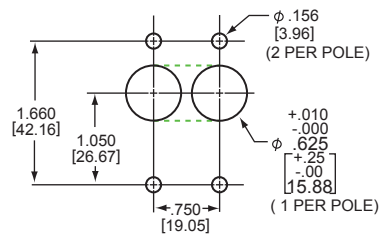

Two Pole

Panel Mounting Detail: Tolerance  $\pm .005$  [0.13] unless noted.

Note: Tolerance  $\pm .015$  [0.38] unless noted. Dimensions in Brackets [ ] are millimeters.  
\* See single pole mounting detail for hole sizes and locations.

### THREE POLE AND FOUR POLE PROTECTORS

The three pole structure consists of three single pole units assembled with an internal mechanical interlock which actuates all units simultaneously. A single toggle handle operates all three poles, or a handle per pole is available. The four pole structure consists of four single pole units assembled with an internal mechanical interlock which actuates all units simultaneously. A double toggle handle operates all four poles, or a handle per pole is available. The individual poles need not have identical characteristics and any series trip pole may have an auxiliary switch. If screw-type terminals are required, the breaker designation will be APG/UPG-666 for a three pole version and APG/UPG-6666 for a four pole version.

Protector poles are numbered consecutively when viewed from the terminal side, with the ON position up, starting with Pole #1 on the left side and proceeding to the right.

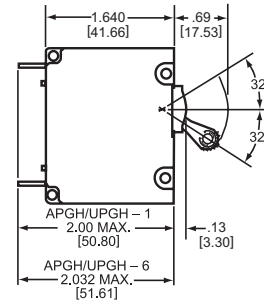

Three Pole

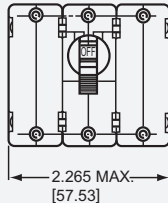

UPG 111

Three Pole

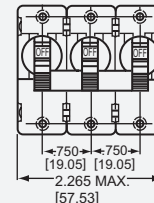

UPGH 111

Mounting Detail

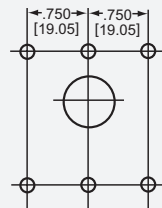

Three Pole\*

Mounting Detail

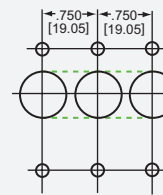

Three Pole\*

\* See single pole mounting detail for hole sizes and locations.

Four Pole

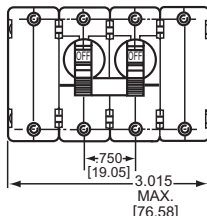

APG/UPG only

Four Pole

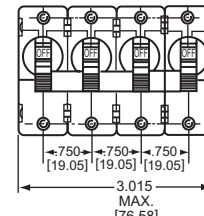

APGH/UPGH only

Mounting Detail

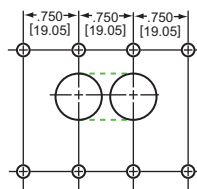

Four Pole\*

Mounting Detail

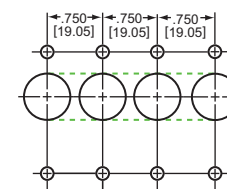

Four Pole\*

## APGHX / UPGHX

Rocker actuated APGHX/UPGHX provides one rocker handle for each pole of a multi-pole circuit protector.

| DIMENSION "A"   |                            |
|-----------------|----------------------------|
| Number of Poles | Dimensions "A"             |
| 2               | 1.510 ± .005 [38.35 ± .13] |
| 3               | 2.265 ± .005 [57.53 ± .13] |

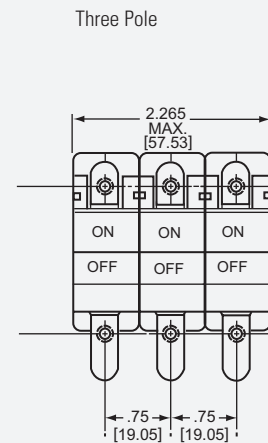
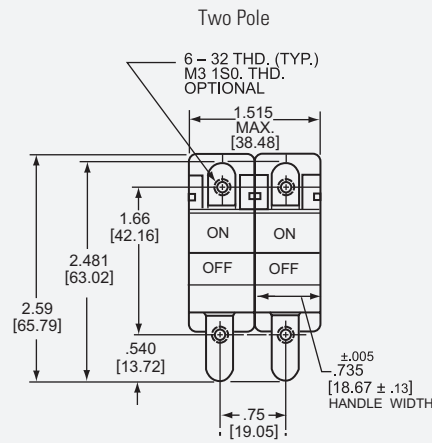
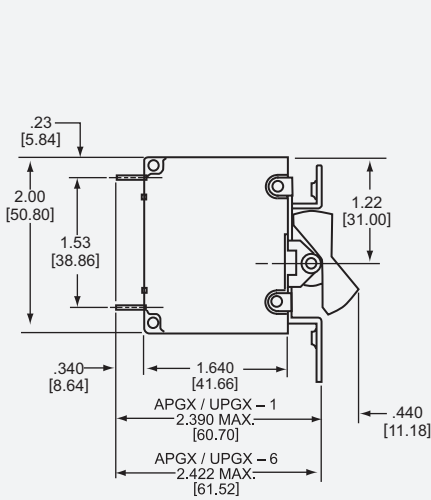

Panel Mounting Detail: Tolerance  
±.005 [.13]  
unless noted.

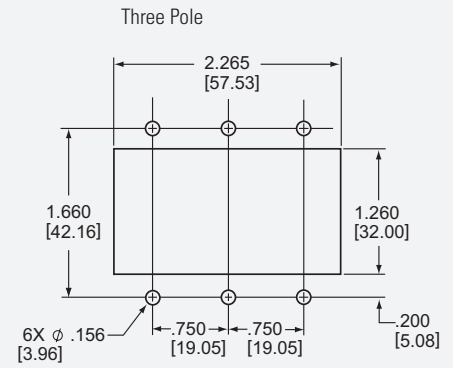
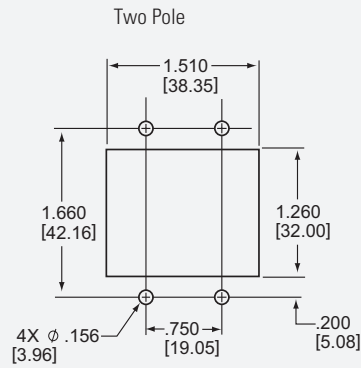

## APGX / UPGX

Rocker actuated APGX / UPGX provides one rocker handle per circuit protector.

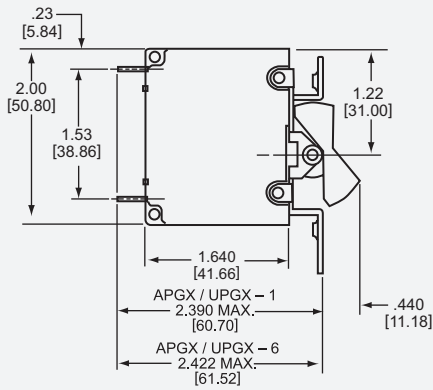

Single Pole

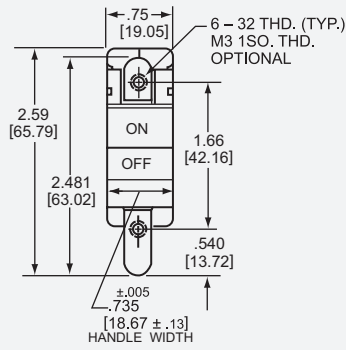

Two Pole

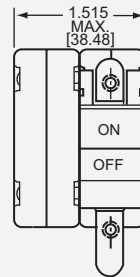

(Optional, handle may be in pole 2 instead of pole 1)

Three Pole

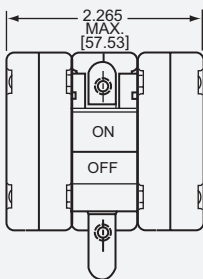

One, Two & Three Pole

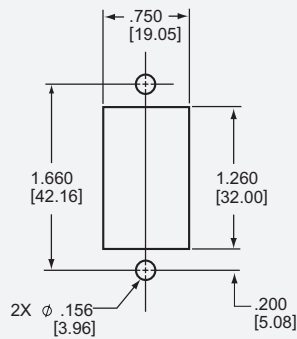

Panel Mounting Detail: Tolerance ±.005 [.13] unless noted.

Note: Tolerance ±.015 [.38] unless noted. Dimensions in Brackets [ ] are millimeters.

## BAT HANDLE / PANEL SEAL (APGN / UPGN)

The APGN is designated to provide circuit protection in harsh and military environments. Waterproof panel integrity is provided by an "O" ring bushing seal and silicon rubber gland within the bushing/handle assembly. Single, two or three pole versions are available with two and three pole versions featuring a single operating handle and mounting bushing.

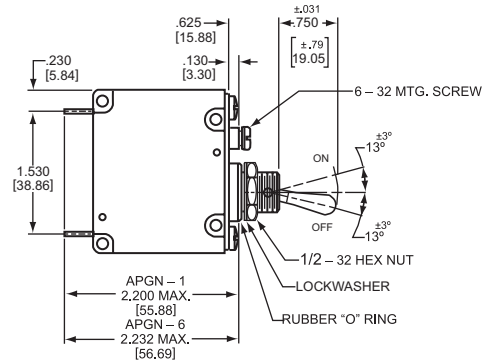

Single Pole

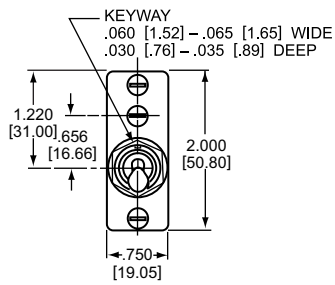

Two Pole

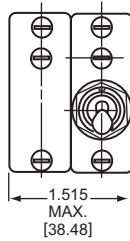

(Optional handle may be in pole 2 instead of pole 1)

Three Pole

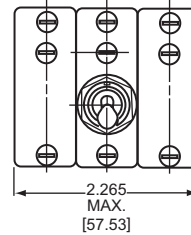

Single Pole

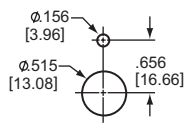

Two Pole\*

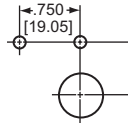

Three Pole\*

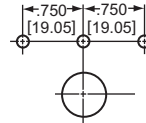

Panel Mounting Detail: Mounting detail tolerance  $\pm .005$  [.13] unless noted.

\*See single pole mounting detail for hole sizes and locations.

Optional Handle

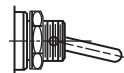

Standard Handle Location  
(Applies to 2 Pole Only)

Toggle Handles

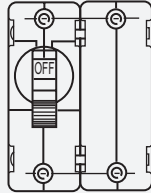

APG/UPG

Bat Handle/  
Panel Seal

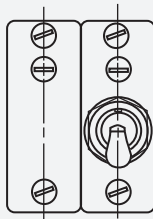

APGN/UPGN

Rocker

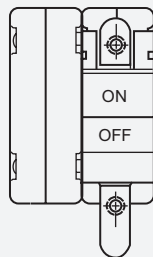

APGX/UPGX

### TOGGLE HANDLES (APG/UPG)

The APG/UPG circuit protector is available with toggle handles in six different colors. For attractive panel appearance, color caps are also available. Handles may be specified in black, white, yellow, red, blue and green. For multi-pole units, specify handle per unit or handle per pole.

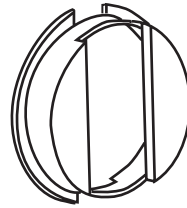

Color Caps

For attractive panel appearance the following color caps are available for use on APG/UPG protectors.

| COLOR CAPS |                  |
|------------|------------------|
| Color      | Order Separately |
| Red        | 762 - 300 - 8046 |
| Green      | 762 - 300 - 8043 |
| White      | 762 - 300 - 8040 |
| Gray       | 762 - 300 - 8041 |
| Blue       | 762 - 300 - 8042 |
| Yellow     | 762 - 300 - 8044 |
| Orange     | 762 - 300 - 8045 |
| Brown      | 762 - 300 - 8047 |
| Black      | 762 - 300 - 8048 |

## IPG MAGNETIC CIRCUIT PROTECTORS

The IPG circuit protectors provide the advantages of magnetic "stand alone" protection and compliance with UL, CSA, SEV, VDE and IEC standards.

They are UL Recognized per UL STD. 1077 as supplementary protectors, CSA Certified per CSA C22.2–No. 235 as supplementary protectors, VDE approved and CE compliant to VDE 0642 (EN60934). Additionally, they conform to the spacing requirements of VDE 0730, 0804, 0805 and 0806, and IEC 950 for use in office machines and data processing equipment.

IPG circuit protectors have current ratings from .020 to 50 amperes, 250Vac, 65Vdc, and an auxiliary switch is available with either gold or silver contacts. They feature one through four pole configurations, with one handle per pole. A choice of handle actuation colors, terminals and hardware are available and international markings are standard. And, with an adapter plate, they will fit in panels cut for Airpax APL and UPL type protectors.

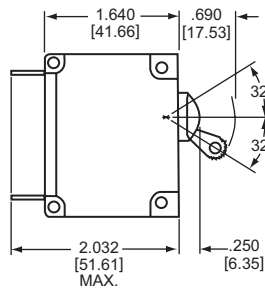

Single Pole

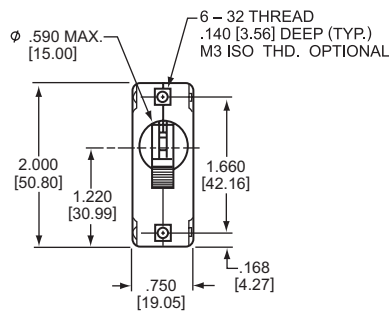

Two Pole

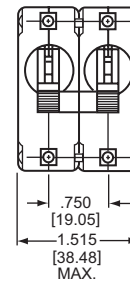

Three Pole

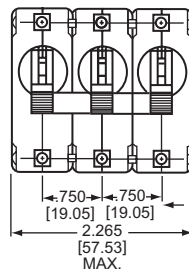

Four Pole

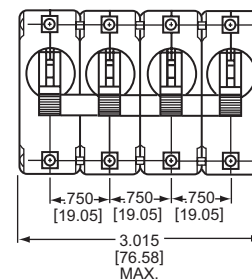

**Note:**

Main terminals are stationary male push-on type .250 [6.35] wide x .031 [.787] thick x .312 [7.92] long or 8-32 x .187 [4.75] screw type ( $\leq 30A$ ). 10-32 x .187 [4.75] screw type ( $> 30A$ ).

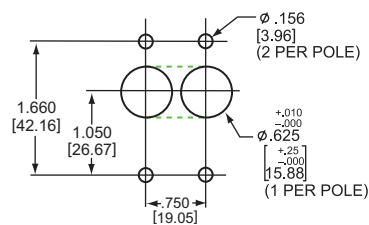

Panel mounting detail:  
Tolerance  $\pm .005$  [.13] unless noted.

Series and Switch Only

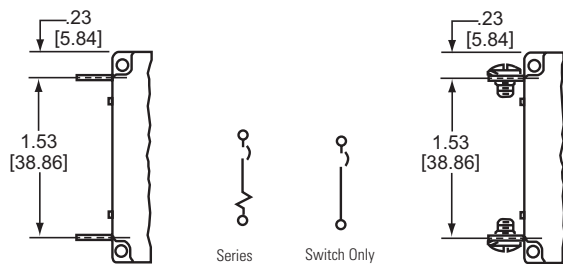

Shunt and Dual Coil

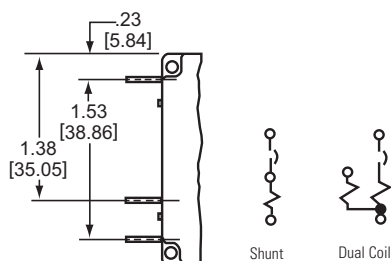

Tapped Coil

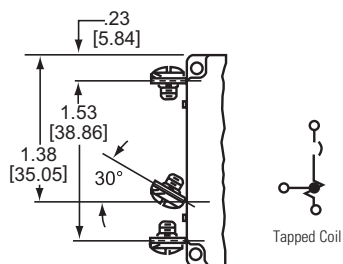

Note: Tolerance  $\pm .015$  [.38] unless noted.  
Dimensions in Brackets [ ] are millimeters.

## APG/UPG/IPG CONFIGURATIONS

### Series Trip

The most popular configuration for magnetic protectors is the series trip where the sensing coil and contacts are in series with the load being protected. The handle position conveniently indicates circuit status. In addition to providing conventional overcurrent protection, it's simultaneously used as an on-off switch.

### Shunt Trip

The shunt trip is designed for controlling two separate loads with one assembly. The control is established by providing overload protection for the critical load. When the current through this load becomes excessive and reaches the trip point, the protector will open and remove power from both loads simultaneously. The total current rating of both loads must not exceed the maximum contact rating.

### Relay Trip

This permits the overload sensing coil to be placed in a circuit which is electrically isolated from the trip contacts. The coil may be actuated by sensors monitoring pressure, flow, temperature, speed, etc. Other typical applications include crowbar, interlock and emergency/rapid shutdown circuitry. Trip may be accomplished by voltage or current, which must be removed after trip.

Relay and Dual Coil

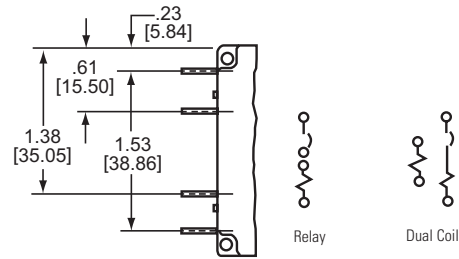

### Auxiliary Switch

This is furnished as an integral part of a series pole in single or multi-pole assemblies. Isolated electrically from the protector's circuit, the switch works in unison with the power contacts and provides indication at a remote location of the protector's on-off status.

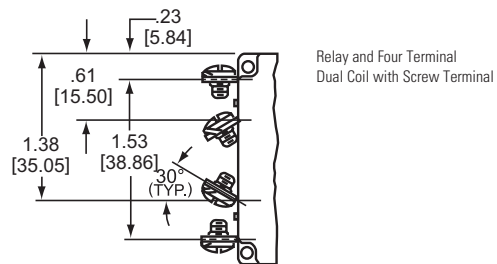

### Voltage Trip

Sometimes called "dump circuits" or "panic trip circuits," these units make it possible to open main power contacts with lower power inputs from one or more sources. This configuration is becoming increasingly more important for sensitive circuitry and denser packaging in automation systems. Available in series, shunt, or relay configurations.

Auxiliary Switch

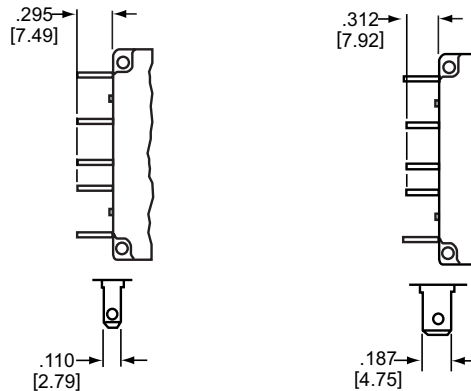

-1 REC 4  
-1 REG 4  
Quick Connect  
Terminals

-1 REC 5  
-1 REG 5  
Quick Connect  
Terminals

Series with Auxiliary Switch  
All auxiliary switch terminals  
.020[.51] thick  
Standard auxiliary switch is REC 4.

C  
NO  
NC  
Breaker in OFF position

Note:

Main terminals are stationary male push-on type .250 [6.35] wide, x .031 [.787] thick, x .312 [7.92] long or 8-32 x [4.75] screw type ( $\leq 30A$ ), 10-32 x .187 [4.75] screw type ( $>30A$ ).

Note:

Tolerance  $\pm .015$  [.38] unless noted. Dimensions in Brackets [ ] are millimeters.

## APG/UPG/IPG OPERATING CHARACTERISTICS

## NOMINAL DCR / IMPEDANCE

| Current Ratings (Amps) | Resistance (ohms) |       |            |                      | Impedance (ohms)   |       |                        |                             | Impedance (ohms) |            |
|------------------------|-------------------|-------|------------|----------------------|--------------------|-------|------------------------|-----------------------------|------------------|------------|
|                        | DC Delays         |       |            |                      | AC, 50/60Hz Delays |       |                        |                             | AC, 400Hz Delays |            |
|                        | 50                | 59    | 51, 52, 53 | Dual Coil 51, 52, 53 | 60                 | 69    | 600, 61, 62 71, 72, 73 | 64, 65, 66 Dual Coil 61, 62 | 40, 49           | 41, 42, 43 |
| 0.05                   | 162               | 540   | 460        | 640                  | 174                | 419   | 582                    | 691                         | 1975             | 1195       |
| 0.10                   | 35.4              | 105   | 155        | 150                  | 42.5               | 103.4 | 119.0                  | 160                         | 495              | 284        |
| 0.50                   | 1.2               | 4.2   | 4.5        | 5.6                  | 1.9                | 4     | 4.1                    | 6.2                         | 22               | 12         |
| 1.0                    | .236              | 1.02  | 1.2        | 1.41                 | .41                | .955  | 1.08                   | 1.56                        | 5.01             | 2.72       |
| 5.0                    | .021              | .048  | .059       | .070                 | .030               | .045  | .048                   | .068                        | .240             | .140       |
| 10.0                   | .0060             | .0121 | .0140      | .0160                | .0075              | .0105 | .0134                  | .0174                       | .0520            | .0283      |
| 15.0                   | .0040             | .0067 | .0092      | .0100                | .0038              | .0068 | .0070                  | .0120                       | .0260            | .0140      |
| 20.0                   | .0032             | .0047 | .0052      | .0070                | .0024              | .0049 | .0050                  | .0069                       | .0140            | .0088      |
| 30.0                   | .0021             | .0036 | .0036      | .0040                | .0022              | .0032 | .0035                  | .0037                       | .0079            | .0043      |
| 50.0                   | .0020             | .0024 | .0026      | .0023                | .0020              | .0020 | .0025                  | .0030                       | .0036            | .0028      |

Notes: DCR and impedance based on 100% rated current applied and stabilized a minimum of one hour.

Tolerance: .02 amperes to 2.5 amperes,  $\pm 20\%$ ; 2.6 amperes to 20 amperes,  $\pm 25\%$ ; 21 amperes to 50 amperes,  $\pm 50\%$ . Consult factory for special values and for coil impedance of delays not shown

## PERCENTAGE OF RATED CURRENT VS TRIP TIME IN SECONDS AT +25°C

| Delay    | 100%    | 125% (Note A) | 150%      | 200%       | 400%      | 600%        | 800%        | 1000%        |
|----------|---------|---------------|-----------|------------|-----------|-------------|-------------|--------------|
| 40       | No Trip | May Trip      | .040 Max. | .035 Max.  | .030 Max. | .025 Max.   | .020 Max.   | .018 Max.    |
| 41       | No Trip | May Trip      | .5 to 8   | .15 to 1.9 | .02 to .4 | .006 to .25 | .004 to .1  | .004 to .05  |
| 42       | No Trip | May Trip      | 5 to 70   | 2.2 to 25  | .40 to 5  | .012 to 2   | .006 to .2  | .006 to .15  |
| 49       | No Trip | .150 Max.     | .100 Max. | .032 Max.  | .020 Max. | .020 Max.   | .020 Max.   | .020 Max.    |
| 43 & 400 | No Trip | May Trip      | 35 to 350 | 12 to 120  | 1.5 to 20 | .1 to 4     | .01 to .250 | .009 to .100 |
| 50       | No Trip | May Trip      | .032 Max. | .024 Max.  | .020 Max. | .018 Max.   | .016 Max.   | .015 Max.    |
| 51       | No Trip | .5 to 6.5     | .3 to 3   | .1 to 1.2  | .031 to 5 | .011 to .25 | .004 to .1  | .004 to .08  |
| 52       | No Trip | 2 to 60       | 1.8 to 30 | 1 to 10    | .15 to 2  | .04 to 1    | .008 to .5  | .006 to .1   |
| 59       | No Trip | .100 Max.     | .070 Max. | .032 Max.  | .020 Max. | .020 Max.   | .020 Max.   | .020 Max.    |
| 53 & 500 | No Trip | 80 to 700     | 40 to 400 | 15 to 150  | 2 to 20   | .7 to 10    | .1 to 3     | .010 to .100 |
| 60       | No Trip | May Trip      | .040 Max. | .035 Max.  | .030 Max. | .025 Max.   | .020 Max.   | .018 Max.    |
| 61       | No Trip | .7 to 12      | .35 to 7  | 130 to 3   | .030 to 1 | .015 to .3  | .01 to .15  | .008 to .1   |
| 62       | No Trip | 10 to 120     | 6 to 60   | 2 to 20    | .2 to 3   | .02 to 2    | .015 to .8  | .01 to .25   |
| 64       | No Trip | .7 to 10      | .35 to 6  | .15 to 3   | .05 to .6 | .025 to .3  | .020 to .22 | .015 to .15  |
| 65       | No Trip | 7 to 90       | 3 to 40   | 1 to 12    | .2 to 3   | .08 to 1    | .03 to .7   | .016 to .3   |
| 66       | No Trip | 50 to 700     | 30 to 400 | 10 to 150  | 1.5 to 20 | .4 to 10    | .05 to 3    | .02 to 2     |
| 69       | No Trip | .120 Max.     | .100 Max. | .050 Max.  | .022 Max. | .017 Max.   | .017 Max.   | .017 Max.    |
| 600      | No Trip | 80 to 700     | 45 to 400 | 15 to 150  | 2 to 20   | .2 to 4     | .025 to 1   | .01 to .2    |

Notes: All trip curves and trip currents are specified with the protector mounted in the normal vertical position at ambient temperature of +25° C. Protectors do not carry current prior to application of overload. A: Ratings above 30 amps may deviate from the above limits by approximately 10% (130% for delay 49).

## DUAL FREQUENCY (50/60HZ) PERCENTAGE OF RATED CURRENT VS TRIP TIME IN SECONDS AT +25°C

| Delay | 100%    | 135%      | 150%      | 200%      | 400%      | 600%       | 800%       | 1000%      |
|-------|---------|-----------|-----------|-----------|-----------|------------|------------|------------|
| 71    | No Trip | .4 to 14  | .2 to 7   | .1 to 3   | .027 to 1 | .015 to .3 | .01 to .15 | .008 to .1 |
| 72    | No Trip | 7 to 130  | 3 to 60   | 1.3 to 20 | .085 to 3 | .02 to 2   | .015 to .8 | .01 to .26 |
| 73    | No Trip | 50 to 700 | 30 to 400 | 10 to 150 | .8 to 20  | .14 to 4   | .025 to 1  | .01 to .26 |

Notes: All trip curves and trip currents are specified with the protector mounted in the normal vertical position at ambient temperature of +25° C. Protectors do not carry current prior to application of overload.

### Inrush Pulse Tolerance

It can be seen that the 64, 65 and 66 delays have a high inrush capability and for most applications an inertia wheel would not be required. Pulse tolerance is defined as a single pulse of half sine wave peak current amplitude of 8 milliseconds duration that will not trip the circuit breaker.

### INRUSH PULSE TOLERANCE

| Delay         | Pulse Tolerance                 |
|---------------|---------------------------------|
| 61, 62        | 10 times rated current (approx) |
| 61F, 62F      | 20 times rated current (approx) |
| 64, 65, 66    | 20 times rated current (approx) |
| 64F, 65F, 66F | 35 times rated current (approx) |

Note: These limits do not apply to dual coil and tapped coil units

### DELAY CURVES (TYP)

#### 50/60Hz Delay Curves (typ)

A choice of delays is offered for DC, 50/60Hz, and 400 Hz applications. Delays 40, 50, 60, 49, 59 and 69 provide fast-acting, instantaneous trip and are often used to protect sensitive electronic equipment (not recommended where known inrush exists). Delays 41, 51, 61 and 71 have a short delay for general purpose applications. Delays 42, 52 and 62 are long enough to start certain types of motors and most transformer and capacitor loads. Delays 43, 53 and 63 are long delays for special motor applications at 400Hz DC and 50/60Hz.

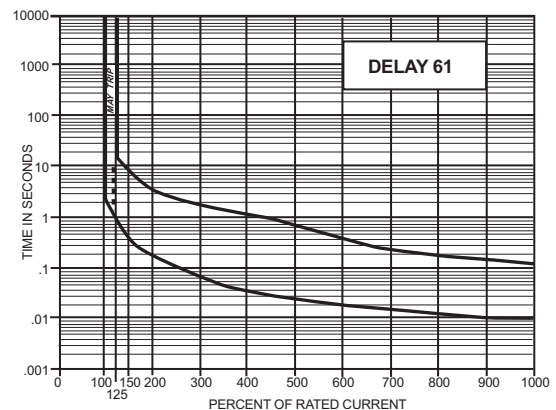
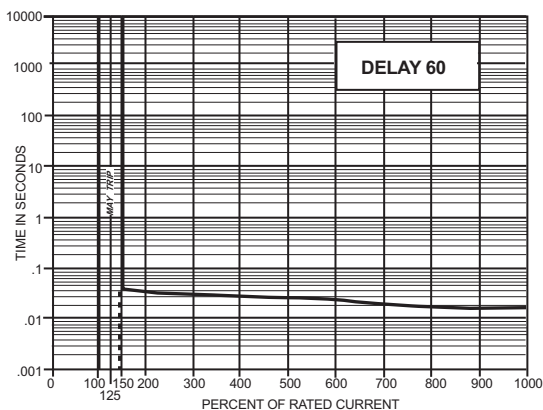

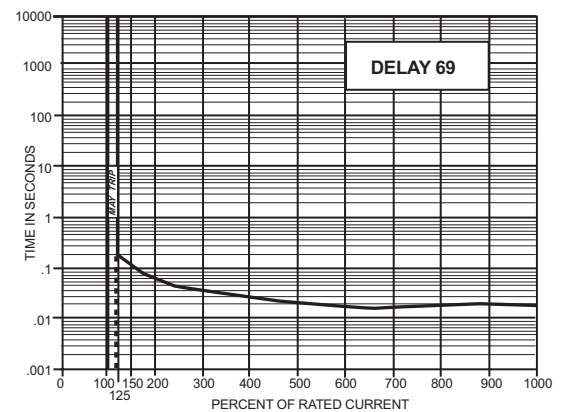
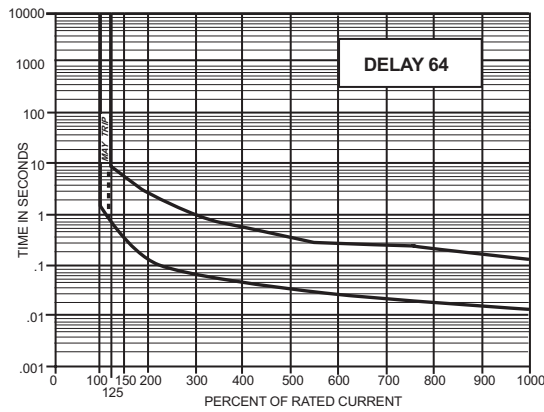
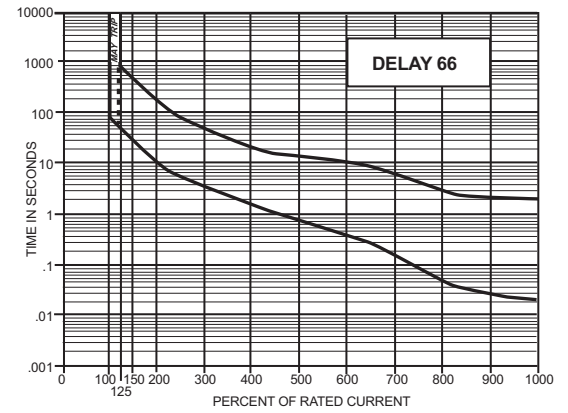
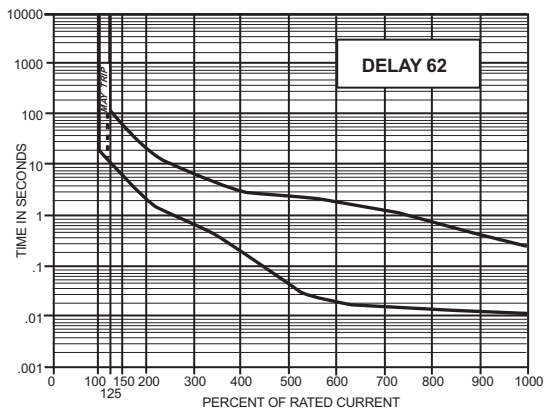
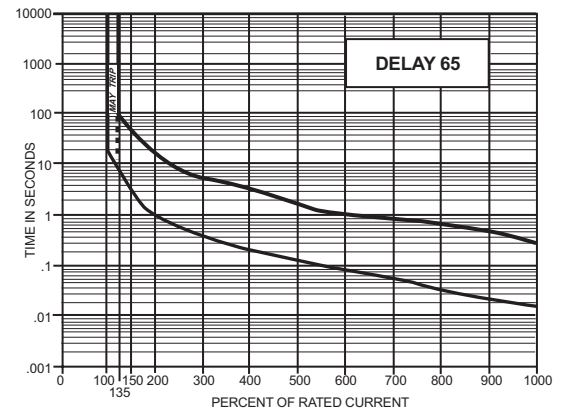

DC Delay Curves (typ)

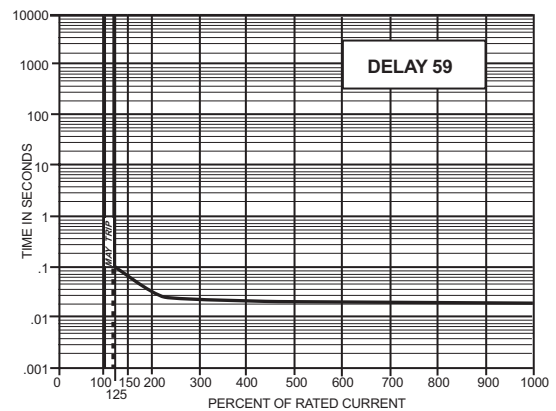
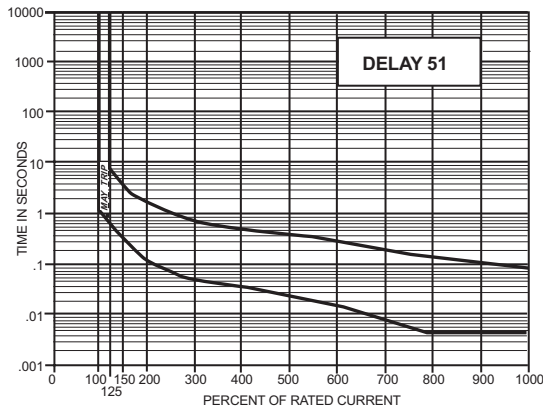
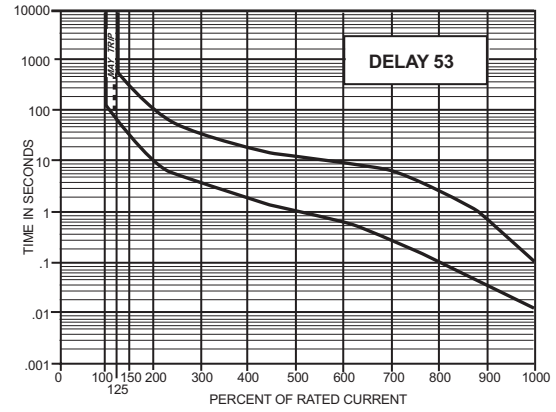
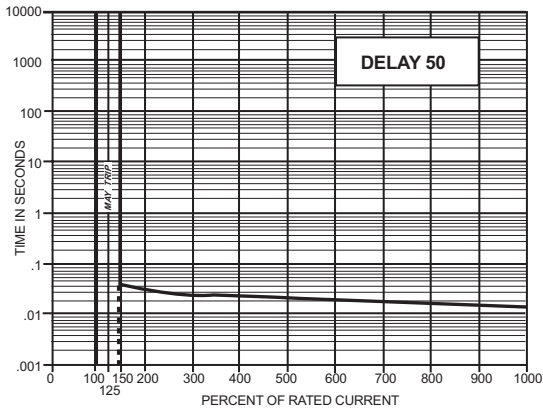
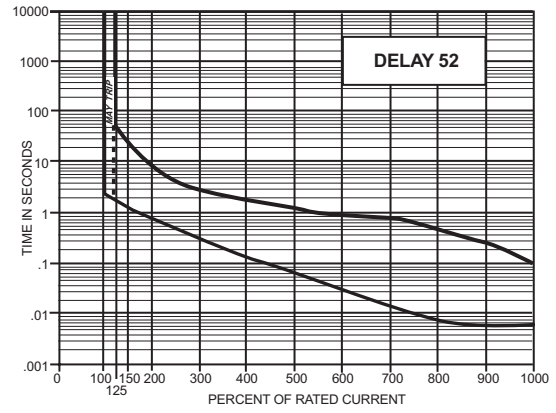

400Hz Delay Curves (typ)

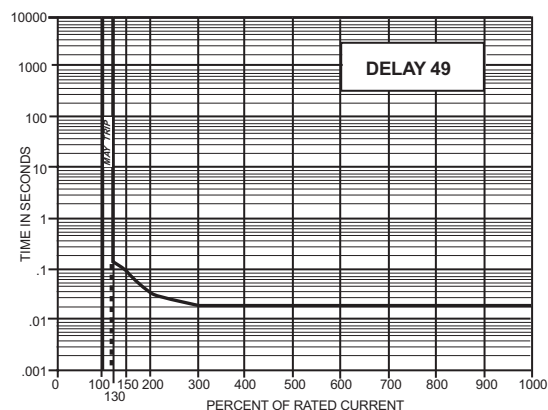
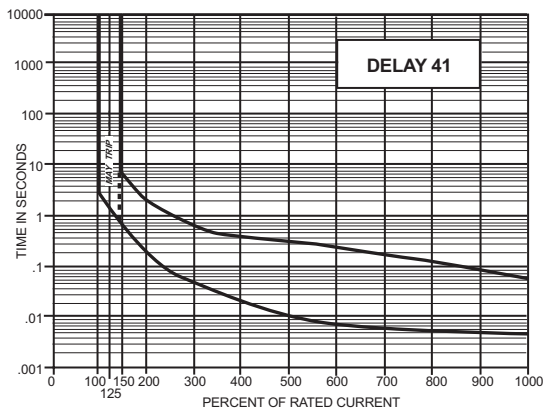
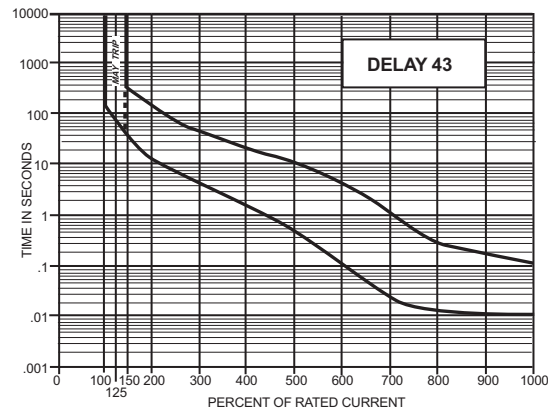
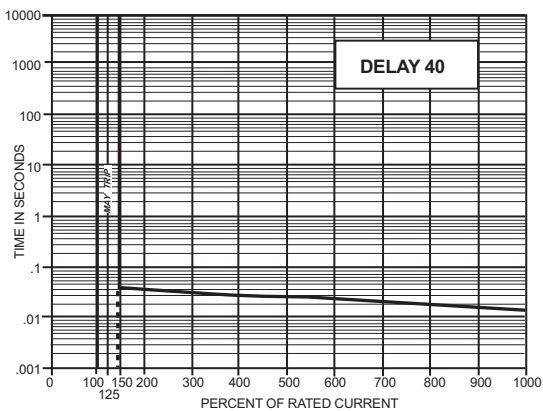
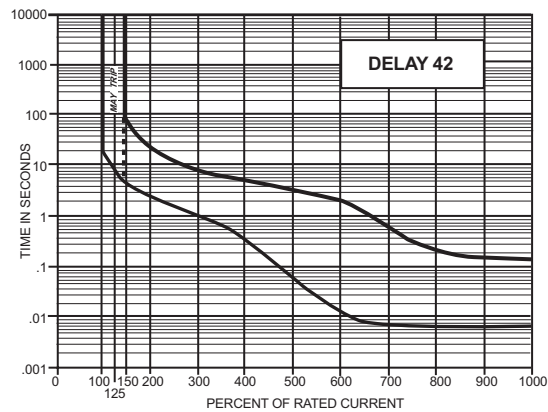

**Trip Free**

Will trip open on overload, even when forcibly held in the ON position.

**Trip Indication**

The operating handle moves positively to the OFF position on overload.

**Ambient Operation**

APG/UPG protectors operate normally in temperatures between -40°C and +85°C.

**Insulation Resistance**

Not less than 100 megohms at 500Vdc.

**Dielectric Strength**

APG/UPG/IPG protectors withstand 1500 volts, 60Hz for 60 seconds between all electrically isolated terminals. Except auxiliary switch terminals shall withstand 600 Volts at 60Hz.

**Endurance**

Withstands 10,000 operations at rated voltage and current or withstands 50 operations of 600% AC or 1000% DC rated current at rated voltage followed by 6000 operations at rated voltage and current, in accordance with UL 1077.

| AUXILIARY SWITCH RATINGS (SILVER) |   |        |       |
|-----------------------------------|---|--------|-------|
| 3.0 amps                          | @ | 120VAC | —     |
| 1.5 amps                          | @ | —      | 32VDC |
| AUXILIARY SWITCH RATINGS (GOLD)   |   |        |       |
| .100 amps                         | @ | 32VAC  | 32VDC |

| AGENCY APPROVALS |                |       |           |                      |                             |                 |
|------------------|----------------|-------|-----------|----------------------|-----------------------------|-----------------|
| Voltage (Volts)  |                |       |           | Rated Current (Amps) | Interrupting Capacity, Amps |                 |
| Max Voltage      | Frequency (Hz) | Phase | Min Poles | UL/CSA               | UL1077 & CSA                | Max Series Fuse |
| 32               | DC             | —     | 1         | .05 to 50            | 2500                        | none            |
| 65               | DC             | —     | 1         | .05 to 30            | 2000                        | none            |
| 130              | DC             | —     | 2         | .05 to 15            | 1000                        | none            |
| 120              | 50/60          | 1     | 1         | .05 to 50            | 3600                        | 200             |
| 120 / 240        | 50/60          | 1     | 2         | .05 to 50            | 1000                        | none            |
| 240              | 50/60          | 1 & 3 | 1         | .05 to 10            | 5000                        | 40              |
| 250              | 50/60          | 1 & 3 | 1         | .05 to 50            | 1000                        | none            |
| 250              | 50/60          | 1 & 3 | 1         | .05 to 50            | 3650                        | 80              |
| 277              | 50/60          | 1     | 1         | .05 to 30            | 1000                        | 120             |
| 277              | 50/60          | 1     | 1         | .05 to 10            | 5000                        | 40              |
| 125              | 400            | 1     | 1         | .05 to 30            | 2000                        | none            |
| 240              | 400            | 1 & 3 | 1         | .05 to 20            | 2100                        | 80              |
| 250              | 400            | 1 & 3 | 1         | .05 to 30            | 1000                        | none            |
| 250              | 400            | 1 & 3 | 1         | .05 to 30            | 3500                        | 125             |
| 277              | 400            | 1     | 1         | .05 to 20            | 1000                        | 80              |

Notes: Series fuse to be a branch-circuit UL approved type K-5 back-up fuse rated at not more than four times the rating of the highest-rated type UPG (15 amps minimum)

**Moisture Resistance**

Meets all the requirements of MIL-PRF-55629 when tested in accordance with Method 106 of MIL-Std. 202.

**Salt Spray (Corrosion)**

Meets requirements of MIL-PRF-55629 when tested in accordance with Method 101 of MIL-Std. 202. All APG/UPG protectors are constructed with stainless steel springs and plated parts. In addition to meeting normal requirements for moisture and salt spray resistance, the protector meets the fungus resistance requirements of MIL-PRF-55629.

**Poles**

One through four poles with the UPGH, one through three poles with all other types.

**MIL-PRF-55629 (APG)**

Single, two and three pole versions, with and without the auxiliary switch option, have been qualified to MIL-PRF-55629.

**Construction**

Series, shunt, relay, dual coil, tapped coil, voltage trip, no-voltage trip, auxiliary switch, switch only. Various delays and combinations.

**Shock**

Withstands 100G or more without tripping while carrying full rated current per MIL-Std. 202, Method 213, Test Condition I. Instant trip protectors are tested at 80% of rated current.

**Vibration**

Withstands 10G without tripping while carrying full rated current per MIL-Std. 202, Method 204, Test Condition A. Instant trip protectors are tested at 80% of rated current.

**APPROXIMATE WEIGHT PER POLE**

| Series      | Ounces | Grams |
|-------------|--------|-------|
| APG/UPG/IPG | 2.2    | 60.5  |
| APGN/UPGN   | 3.0    | 76.2  |

**RECOMMENDED TORQUE SPECIFICATIONS**

| Component                 | Torque (in-lbs) |
|---------------------------|-----------------|
| 6-32 Mounting Inserts     | 6 to 8          |
| M3 Mounting Screws        | 4 to 5          |
| 8-32 Screw Terminals      | 10 to 12        |
| M4 Terminal Screws        | 10 to 12        |
| 10-32 Screw Terminals     | 14 to 15        |
| M5 Screw Terminals        | 14 to 15        |
| 1/2 - 32 Mounting Bushing | 30 to 35        |

*Where applicable, mechanical support must be provide to the terminals when applying torque*

### APG / UPG Decision Table - How to Order

The ordering code for APG/UPG circuit protectors may be determined by following the steps in the decision tables shown here.

The coding given permits a self-assigning part number but with certain limitations. Units with mixed ratings, combinations of styles, or constructions not listed in the third decision table, require a factory-assigned part number. With these, it is suggested that order entry be by description and/or drawings, and a part number will be established. Additionally, it is standard policy to establish a factory-assigned part number whenever a descriptive drawing exists to provide cross reference, traceability and manufacturing control.

When specifying a circuit protector for AC motor start or high inrush applications, the peak amplitude and surge duration should be specified for factory assistance in rating selection.

For example, the following is the code for a single pole UPG, quick-connect type terminal series unit with auxiliary switch, designed for operation in a 50/60Hz circuit. It has a short time delay and a rating of 20 amperes. A white handle is specified by the seventh decision table.

To determine the ordering number for your particular APG/UPG unit, simply follow the steps shown. You may use this number to place an order or as a reference for further questions you may have.

#### Notes:

- A It is recommended that power leads be soldered to protectors having quick-connect terminals for current trip ratings above 10 amperes.
- B The standard current values for 100% of rated current are listed. Please consult an Airpax office or sales representative for other values.
- C UL recognized and CSA certified applications above 30 amperes are restricted to loads having a power factor of 75 minimum and limited to 32Vdc only. Standard terminals on ratings over 30 amperes are 10-32 screw type.
- D Four pole protectors are available only in the APGH/UPGH and APG/UPG types. The APGH/UPGH four pole provides one handle per pole, while the APG/UPG four pole has handles in the center two poles only, for simplified mounting.
- E Sub panel mount available in APGX/UPGX configuration only.
- F When "A" is specified in the sixth decision in conjunction with APG/UPG-6 type, metric screw terminals are supplied.
- G If a circuit breaker is marked in this manner, it means 277V per pole – single phase source. Thus, if a two or three pole unit is marked 277V, all line terminals must be connected to the same phase, assuming the 277V is taken from line to neutral of 3 phase 277/480V system.

| 1 First Decision |  |
|------------------|--|
| Type             |  |
| Type             | Description  |
| APG              | One handle per unit  |
| UPG              | One handle per unit<br>UL Recognized and<br>CSA Certified                  |
| APGX             | One rocker handle per unit   |
| UPGX             | One rocker handle per<br>unit UL Recognized and<br>CSA Certified           |
| APGN             | Panel seal<br>(one bat handle per unit)                                    |
| UPGN             | Panel seal (one bat handle<br>per unit) UL Recognized and<br>CSA Certified |
| APGH             | One handle per pole  |
| UPGH             | One handle per pole<br>UL Recognized and<br>CSA Certified                  |
| APGHX            | One rocker handle per pole   |
| UPGHX            | One rocker handle per pole<br>UL Recognized and<br>CSA Certified           |

| 2 Second Decision       |                 |                            |
|-------------------------|-----------------|----------------------------|
| Poles (Note A)          |                 |                            |
| Quick-Connect Terminals | Screw Terminals | Number of poles            |
| 1                       | 6               | Single pole unit           |
| 11                      | 66              | Two pole unit              |
| 111                     | 666             | Three pole unit            |
| 1111                    | 6666            | Four pole unit<br>(Note D) |

**3** Third Decision

Internal Configuration

|        |  |
|--------|--|
| -0     | Switch only (omit 4th and 5th decisions)             |
| -1     | Series   |
| -1REC4 | Auxiliary switch* .110 quick-connect                 |
| -1REG4 | Auxiliary switch* (Gold Contacts) .110 quick-connect |
| -1REC5 | Auxiliary switch* .187 quick-connect                 |
| -3     | Shunt (up to 30 amperes only)                        |
| -4     | Relay (up to 30 amperes only)                        |

\*Only one auxiliary switch is normally supplied on two and three pole units. Can be used for solder terminals also. Switch is located in the right-hand pole (viewed from terminal end) unless otherwise specified. Multi-pole units with mixed construction, poles numbered left to right when viewed from terminal end.

**4** Fourth Decision

Hz and Delay

|       |                                   |
|-------|-----------------------------------|
| -40   | 400Hz 150% instant trip           |
| -41   | 400Hz short delay                 |
| -42   | 400Hz long delay                  |
| -43*  | 400Hz motor start                 |
| -49   | 400Hz 130% instant trip           |
| -50   | DC 150% instant trip              |
| -51   | DC short delay                    |
| -52   | DC long delay                     |
| -53*  | DC motor start                    |
| -59   | DC 125% instant trip              |
| -60   | 50/60Hz 150% instant trip         |
| -61   | 50/60Hz short delay               |
| -62   | 50/60Hz long delay                |
| -600* | 50/60Hz motor start delay         |
| -64   | 50/60Hz, short delay (high pulse) |
| -65   | 50/60Hz, long delay (high pulse)  |
| -66*  | 50/60Hz, motor start (high pulse) |
| -69   | 50/60Hz 125% instant trip         |
| -71   | DC, 50/60Hz short delay           |
| -72   | DC, 50/60Hz long delay            |
| -73*  | DC, 50/60Hz motor start delay     |

For addition of inertial delay, add an "F" to any delay number. \* Not available above 30 amperes.

**7** Seventh Decision

Handle/Actuator Color\*\*

Toggle Handle Color †

|                       |                                     |
|-----------------------|-------------------------------------|
| -01                   | Black w/ white markings             |
| -11                   | Yellow w/ black markings            |
| -21                   | Red w/ white markings               |
| -31                   | Blue w/ white markings              |
| -41                   | Green w/ white markings             |
| -91                   | White w/ black markings             |
| Rocker/Actuator Color |                                     |
| -00                   | Black w/o markings                  |
| -01                   | Black w/ white markings             |
| -02                   | Red w/o markings                    |
| -05                   | Opaque white w/o markings           |
| -08                   | Gray w/o markings                   |
| -09                   | Translucent white w/o markings      |
| -21                   | Red w/ white markings               |
| -51                   | Opaque white w/ black markings      |
| -81                   | Gray w/ black markings              |
| -91                   | Translucent white w/ black markings |

\*\*Not available for bat handle.  
†Unmarked handles are available. Please consult factory.

Example:

UPG 1- 1REC4- 61- 203- 09

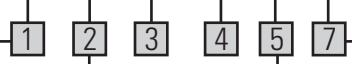

**5** Fifth Decision

Rated Current (Note B)

| Current Code | Ratings (Amps) | Current Code | Ratings (Amps) |
|--------------|----------------|--------------|----------------|
| -101         | .100           | -103         | 10.0           |
| -251         | .250           | -153         | 15.0           |
| -501         | .500           | -203         | 20.0           |
| -751         | .750           | -303         | 30.0           |
| -102         | 1.0            | -353         | 35.0*          |
| -252         | 2.5            | -403         | 40.0*          |
| -502         | 5.0            | -503         | 50.0*          |
| -752         | 7.5            |              |                |

See page 122 for maximum voltage ratings. (\*Note C)

Standard current ratings listed. For other ratings, please consult factory.

**6** Sixth Decision

Optional

|    |  |
|----|--|
| -A | Metric thread mounting (Not available on APGN/UPGN) (Note F) |
| -B | Sub panel mount (Note E)                                     |
| -C | 277Vac 50/60Hz (Note G)                                      |
| -H | International handle markings                                |

One or more descriptions may be used as required. If this table is not used, go directly to the seventh decision.

## IPG Decision Table - How to Order

The ordering code for IPG circuit protectors may be determined by following the steps in the decision tables shown here.

The coding given permits a self-assigning part number but with certain limitations. Units with mixed ratings, combinations of styles, or constructions not listed in the third decision table, require a factory-assigned part number. With these, it is suggested that order entry be by description and/or drawings, and a part number will be established. Additionally, it is standard policy to establish a factory-assigned part number whenever a descriptive drawing exists to provide cross reference, traceability and manufacturing control.

When specifying a circuit protector for AC motor start or high inrush applications, the peak amplitude and surge duration should be specified for factory assistance in rating selection.

For example, the following is the code for a single pole IPG, quick-connect type terminal series unit with auxiliary switch, designed for operation in a 50/60Hz circuit. It has a short time delay and a rating of 20 amperes. Metric mounting inserts and a white handle are also specified.

To determine the ordering number for your particular IPG unit, simply follow the steps shown. You may use this number to place an order or as a reference for further questions you may have.

### Notes:

- A It is recommended that power leads be soldered to protectors having push-on terminals for current trip ratings above 10 amperes.
- B The standard current values for 100% of rated current are listed in the fifth decision table. Please consult an Airpax office or sales representative for other values.
- C All IPG protectors meet normal requirements for moisture and salt spray resistance.
- D UL recognized and CSA certified applications above 30 amperes are restricted to loads having a power factor of .75 minimum, and limited to 32Vdc only. VDE approval above 30 amperes is restricted to 32Vdc and 120Vac 50/60Hz. Standard terminals on ratings over 30 amperes are 10-32 screw type.
- E When "A" is specified in the sixth decision in conjunction with IPG-6 type, metric screw terminals are supplied.

| 1 First Decision |  |                   |
|------------------|--|-------------------|
| Type             |  |                   |
| Type             | Description  | Std. Handle Color |
| IPG              | Single pole with one handle per unit (Not available in multi-pole configuration) | Black             |
| IPGH             | Multi-pole with handle per pole  | Black             |

| 2 Second Decision |                 |                 |
|-------------------|-----------------|-----------------|
| Poles             |                 |                 |
| Push-On Terminals | Screw Terminals | Number of poles |
| 1                 | 6               | Single pole     |
| 11                | 66              | Two pole        |
| 111               | 666             | Three pole      |
| 1111              | 6666            | Four pole       |

| 3 Third Decision       |   |
|------------------------|---|
| Internal Configuration |   |
| -0                     | Switch only (omit 4th and 5th decisions)                |
| -1                     | Series  |
| -1REC4                 | Auxiliary switch*<br>.110 quick-connect                 |
| -1REG4                 | Auxiliary switch* (Gold Contacts)<br>.110 quick-connect |
| -1REC5                 | Auxiliary switch*<br>.187 quick-connect                 |
| -3                     | Shunt (up to 30 amperes only)                           |

\*Only one auxiliary switch is normally supplied on two and three pole units. Switch is located in the right-hand pole (viewed from terminal end) unless otherwise specified.

| 4 Fourth Decision |                                   |
|-------------------|-----------------------------------|
| Hz and Delay      |                                   |
| -40               | 400Hz 150% instant trip           |
| -41               | 400Hz short delay                 |
| -42               | 400Hz long delay                  |
| -43*              | 400Hz motor start                 |
| -49               | 400Hz 130% instant trip           |
| -50               | DC 150% instant delay             |
| -51               | DC short delay                    |
| -52               | DC long delay                     |
| -53*              | DC motor start                    |
| -59               | DC 125% instant trip              |
| -60               | 50/60Hz 150% instant trip         |
| -61               | 50/60Hz short delay               |
| -62               | 50/60Hz long delay                |
| -64               | 50/60Hz, short delay (high pulse) |
| -65               | 50/60Hz, long delay (high pulse)  |
| -66*              | 50/60Hz, motor start (high pulse) |
| -69               | 50/60Hz 125% instant trip         |

For addition of inertial delay, add an "F" to any delay number.  
\* Not available above 30 amperes.

| 5 Fifth Decision        |                |              |                |
|-------------------------|----------------|--------------|----------------|
| Nominal Amperage Rating |                |              |                |
| Current Code            | Ratings (Amps) | Current Code | Ratings (Amps) |
| -101                    | .100           | -103         | 10.0           |
| -251                    | .250           | -153         | 15.0           |
| -501                    | .500           | -203         | 20.0           |
| -751                    | .750           | -303         | 30.0           |
| -102                    | 1.0            | -353         | 35.0*          |
| -252                    | 2.5            | -403         | 40.0*          |
| -502                    | 5.0            | -503         | 50.0*          |
| -752                    | 7.5            |              |                |

See page 122 for maximum voltage ratings. (\*Note D)  
Standard current ratings listed. For other ratings, please consult factory.

| 6 Sixth Decision |                                 |
|------------------|---------------------------------|
| Optional         |                                 |
| -A               | Metric thread mounting (Note E) |

When this table is not used, table 7 may be substituted and U.S. thread will be supplied.

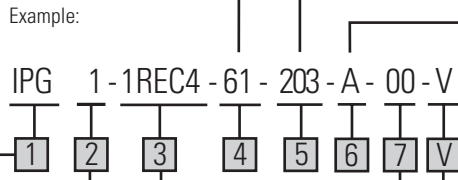



V = VDE Approved

The shaded areas denote VDE approval options. This approval requires the addition of a V at the end of the part number. The V will be added to any part number formed entirely from shaded decisions. If non-shaded areas are selected, the unit will not be VDE approved, but other approvals still apply.

| 7 Seventh Decision  |        |
|---------------------|--------|
| IPG and IPGH        |        |
| Toggle Handle Color |        |
| -00                 | Black  |
| -10                 | Yellow |
| -20                 | Red    |
| -30                 | Blue   |
| -40                 | Green  |
| -90                 | White  |

## Looking for pricing, stock, or lifecycle information?

Click below to explore more details on WIN SOURCE:

-  [View UPG1-5657-1 on WIN SOURCE](#)
-  [Sensata Technologies/Airpax Information](#)

## Optimize Your Supply Chain with WIN SOURCE Solutions

-  Global Sourcing Solution
-  Obsolete Management
-  Cost Control Management
-  Shortage Management
-  Alternative Solution
-  Excess Inventory Management