



**THE DATASHEET OF
ACF321825-151-TD01**



3-terminal Filters

For signal line

ACF series

Type:	ACF3225	[1210 inch]*
	ACF4532	[1812 inch]

* Dimensions Code [EIA]

Issue date: September 2011

- All specifications are subject to change without notice.
 - Conformity to RoHS Directive: This means that, in conformity with EU Directive 2002/95/EC, lead, cadmium, mercury, hexavalent chromium, and specific bromine-based flame retardants, PBB and PBDE, have not been used, except for exempted applications.
-

3-terminal Filters For Signal Line

Conformity to RoHS Directive

ACF Series ACF321825, ACF451832

FEATURES

- The ACF series consists of products with superior attenuation characteristics, in which the T-type filter circuit is magnetically shielded with ferrite.
- The series offers even greater attenuation characteristics when used in a stable circuit on the ground.
- The ACF series is ideal for high-density circuit design, since the series is vertically mounted and does not require much mounting space.
- Available for reflow soldering.
- It is a product conforming to RoHS directive.

PRODUCT IDENTIFICATION

ACF 321825 - 223 - T D□□
(1) (2) (3) (4) (5)

- (1) Series name
(2) Dimensions
(3) Type
(4) Packaging style
(5) TDK internal code

TEMPERATURE RANGES

Operating/Storage	-25 to +85°C
-------------------	--------------

PACKAGING STYLE AND QUANTITIES

Packaging style	Quantity
Taping	1000 pieces/reel

HANDLING AND PRECAUTIONS

- Before soldering, be sure to preheat components. The preheating temperature should be set so that the temperature difference between the solder temperature and product temperature does not exceed 150°C.
- After mounting components onto the printed circuit board, do not apply stress through board bending or mishandling.
- The inductance value may change due to magnetic saturation if the current exceeds the rated maximum.
- Do not expose the inductors to stray magnetic fields.
- Avoid static electricity discharge during handling.
- When hand soldering, apply the soldering iron to the printed circuit board only. Temperature of the iron tip should not exceed 350°C. Soldering time should not exceed 3 seconds.

• Conformity to RoHS Directive: This means that, in conformity with EU Directive 2002/95/EC, lead, cadmium, mercury, hexavalent chromium, and specific bromine-based flame retardants, PBB and PBDE, have not been used, except for exempted applications.

• Please contact our Sales office when your application is considered the following:
The device's failure or malfunction may directly endanger human life (e.g. application for automobile/aircraft/medical/nuclear power devices, etc.)

• All specifications are subject to change without notice.

ACF321825 TYPE

SHAPES AND DIMENSIONS/CIRCUIT DIAGRAM

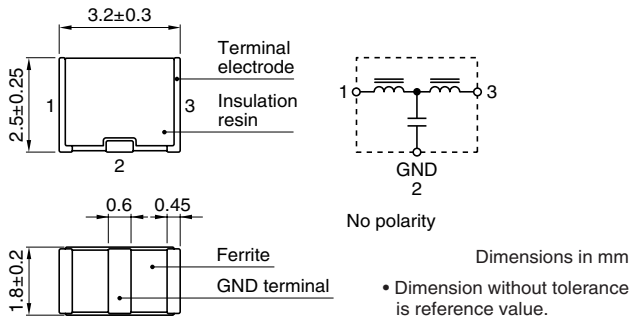

RECOMMENDED PC BOARD PATTERN REFLOW SOLDERING

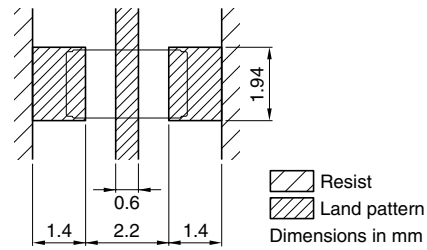

ELECTRICAL CHARACTERISTICS

Part No.	25dB attenuation frequency range (MHz)	Rated voltage E _{dc} (V)max.	Rated current (mA)max.	DC resistance (Ω)max. [Terminal No.1 to 3]	Insulation resistance (MΩ)min. [Terminal No.1 to 2/No.2 to 3]
ACF321825-223	11 to 55	20	300	0.15	1000
ACF321825-103	17 to 60	20	300	0.15	1000
ACF321825-682	22 to 75	20	300	0.15	1000
ACF321825-472	30 to 85	20	300	0.15	1000
ACF321825-332	37 to 90	20	300	0.15	1000
ACF321825-222	45 to 105	20	300	0.15	1000
ACF321825-152	60 to 115	20	300	0.15	1000
ACF321825-102	80 to 140	20	300	0.15	1000
ACF321825-681	95 to 150	20	300	0.15	1000
ACF321825-471	120 to 180	20	300	0.15	1000
ACF321825-331	130 to 210	20	300	0.15	1000
ACF321825-221	170 to 250	20	300	0.15	1000
ACF321825-151	205 to 280	20	300	0.15	1000
ACF321825-101	265 to 340	20	300	0.15	1000
ACF321825-680	340 to 420	20	300	0.15	1000
ACF321825-470	420 to 500	20	300	0.15	1000
ACF321825-330	500 to 600	20	300	0.15	1000
ACF321825-220	600 to 700	20	300	0.15	1000

TYPICAL ELECTRICAL CHARACTERISTICS

ATTENUATION vs. FREQUENCY CHARACTERISTICS

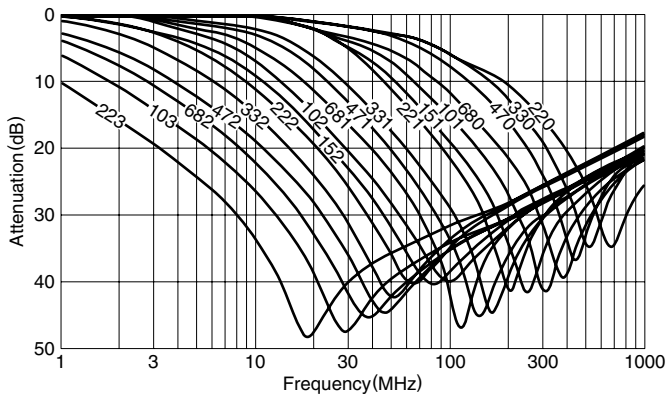

MEASURING CIRCUIT

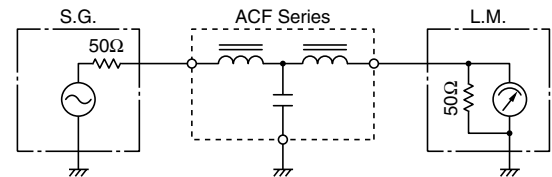

ACF451832 TYPE

SHAPES AND DIMENSIONS/CIRCUIT DIAGRAM



RECOMMENDED PC BOARD PATTERN REFLOW SOLDERING



ELECTRICAL CHARACTERISTICS

Part No.	25dB attenuation frequency range (MHz)	Rated voltage E _{dc} (V)max.	Rated current (mA)max.	DC resistance (Ω)max. [Terminal No.1 to 3]	Insulation resistance (MΩ)min. [Terminal No.1 to 2/No.2 to 3]
ACF451832-333	7 to 60	50	300	0.15	1000
ACF451832-223	9 to 65	50	300	0.15	1000
ACF451832-153	11 to 70	50	300	0.15	1000
ACF451832-103	15 to 75	50	300	0.15	1000
ACF451832-682	20 to 85	50	300	0.15	1000
ACF451832-472	25 to 90	50	300	0.15	1000
ACF451832-332	35 to 100	50	300	0.15	1000
ACF451832-222	40 to 110	50	300	0.15	1000
ACF451832-152	50 to 130	50	300	0.15	1000
ACF451832-102	65 to 150	50	300	0.15	1000
ACF451832-681	75 to 160	50	300	0.15	1000
ACF451832-471	95 to 180	50	300	0.15	1000
ACF451832-331	115 to 205	50	300	0.15	1000
ACF451832-221	150 to 250	50	300	0.15	1000
ACF451832-151	190 to 290	50	300	0.15	1000
ACF451832-101	235 to 335	50	300	0.15	1000
ACF451832-680	295 to 395	50	300	0.15	1000
ACF451832-470	360 to 460	50	300	0.15	1000
ACF451832-330	450 to 550	50	300	0.15	1000
ACF451832-220	550 to 650	50	300	0.15	1000

TYPICAL ELECTRICAL CHARACTERISTICS

ATTENUATION vs. FREQUENCY CHARACTERISTICS



MEASURING CIRCUIT

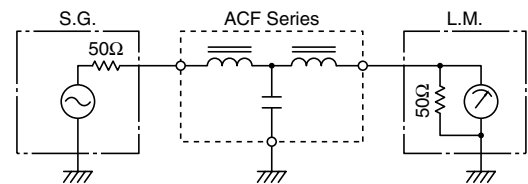

PACKAGING STYLES

REEL DIMENSIONS

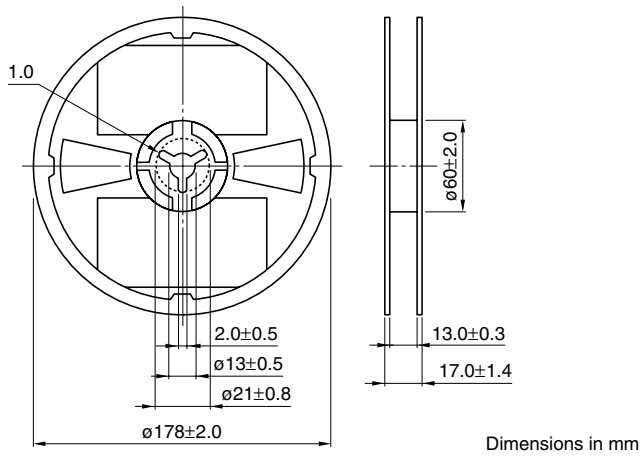

TAPE DIMENSIONS

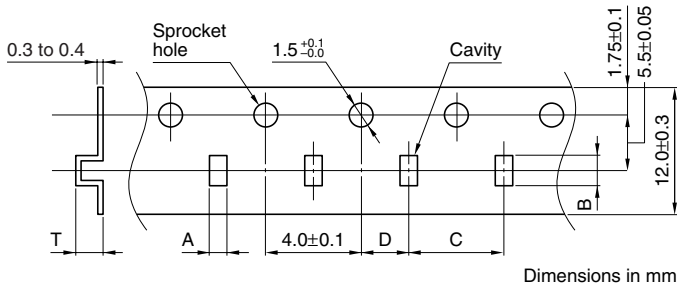

Type	A	B	C	D	T
321825	2.2 ± 0.2	3.7 ± 0.2	4.0 ± 0.1	2.0 ± 0.05	3.3max.
451832	2.2 ± 0.2	5.2 ± 0.2	4.0 ± 0.1	2.0 ± 0.05	3.8max.

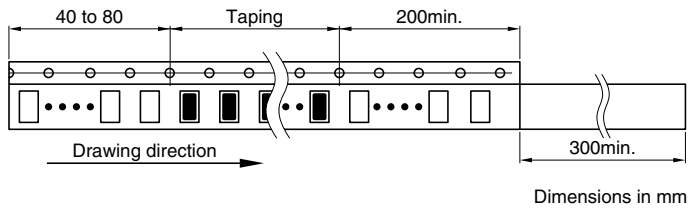

Looking for pricing, stock, or lifecycle information?

Click below to explore more details on WIN SOURCE:

- ⊖ [View ACF321825-151-TD01](#) on WIN SOURCE
- ⊖ [TDK Corporation](#) Information

Optimize Your Supply Chain with WIN SOURCE Solutions

- ✓ Global Sourcing Solution
- ✓ Obsolete Management
- ✓ Cost Control Management
- ✓ Shortage Management
- ✓ Alternative Solution
- ✓ Excess Inventory Management