

FJZ594J

FJZ594J

Capacitor Microphone Applications

- Especially Suited for use in Audio, Telephone Capacitor Microphones
- Excellent Voltage Characteristic
- Excellent Transient Characteristic



Si N-channel Junction FET

Absolute Maximum Ratings $T_a=25^\circ\text{C}$ unless otherwise noted

Symbol	Parameter	Ratings	Units
V_{GDO}	Gate-Drain Voltage	-20	V
I_G	Gate Current	10	mA
I_D	Drain Current	1	mA
P_D	Power Dissipation	100	mW
T_J	Junction Temperature	150	$^\circ\text{C}$
T_{STG}	Storage Temperature	-55 ~ 150	$^\circ\text{C}$

Electrical Characteristics $T_a=25^\circ\text{C}$ unless otherwise noted

Symbol	Parameter	Test Condition	Min.	Typ.	Max.	Units
BV_{GDO}	Gate-Drain Breakdown Voltage	$I_G = -100\mu\text{A}$	-20			V
$V_{GS(off)}$	Gate-Source Cut-off Voltage	$V_{DS}=5\text{V}, I_D=1\mu\text{A}$		-0.6	-1.5	V
I_{DSS}	Drain Current	$V_{DS}=5\text{V}, V_{GS}=0$	150		350	μA
$ y_{fs} $	Forward Transfer Admittance	$V_{DS}=5\text{V}, V_{GS}=0, f=1\text{MHz}$	0.4	1.2		mS
C_{ISS}	Input Capacitance	$V_{DS}=5\text{V}, V_{GS}=0, f=1\text{MHz}$		3.5		pF
C_{RSS}	Output Capacitance	$V_{DS}=5\text{V}, V_{GS}=0, f=1\text{MHz}$		0.65		pF
$V_{CC}=4.5\text{V}, R_L=1\text{k}\Omega, C_{in}=15\text{pF}$, See the Specified Test Circuit						
G_V	Voltage Gain	$V_{IN}=10\text{mV}, f=1\text{KHz}$		-3		dB
ΔG_{VV}	Reduced Voltage Characteristic	$V_{IN}=10\text{mV}, f=1\text{KHz}$ $V_{CC}=4.5\text{V} \rightarrow 1.5\text{V}$		-1.2	-3.5	dB
ΔG_{Vf}	Frequency Characteristic	$f=1\text{KHz to } 110\text{Hz}$			-1	dB
Z_{IN}	Input Resistance	$f=1\text{KHz}$	25			$\text{M}\Omega$
Z_O	Output Resistance	$f=1\text{KHz}$			700	Ω
THD	Total Harmonic Distortion	$V_{IN}=10\text{mV}, f=1\text{KHz}$		1		%
V_{NO}	Output Noise Voltage	$V_{IN}=0, A \text{ curve}$			-110	dB

Thermal Characteristics $T_C=25^\circ\text{C}$ unless otherwise noted

Symbol	Parameter	Max	Units
$R_{\theta JA}$	Thermal Resistance, Junction to Ambient	1250	$^\circ\text{C/W}$

Typical Characteristics

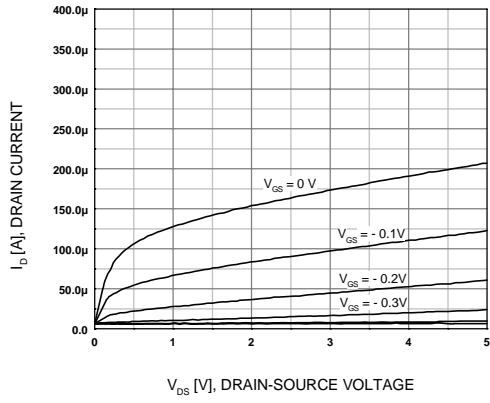

Figure 1. Static Characteristics

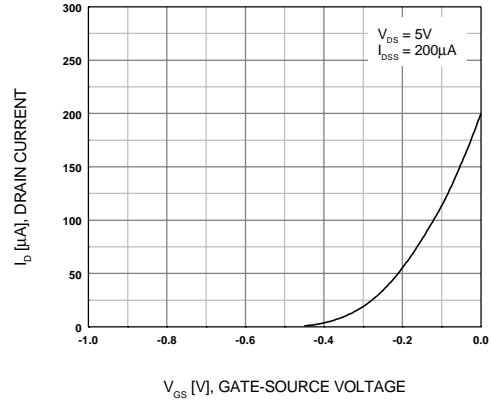

Figure 2. Transfer Characteristic

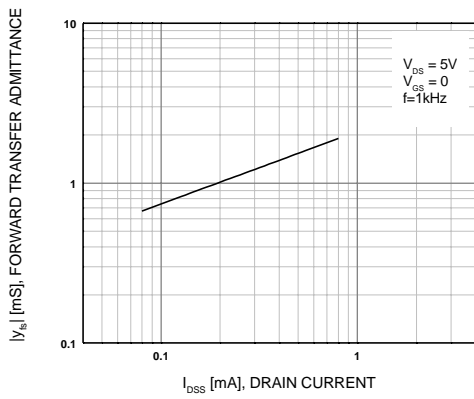

Figure 3. Forward Transfer Admittance

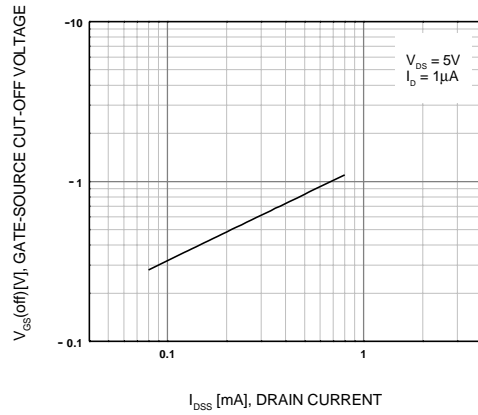

Figure 4. Cut-Off Voltage

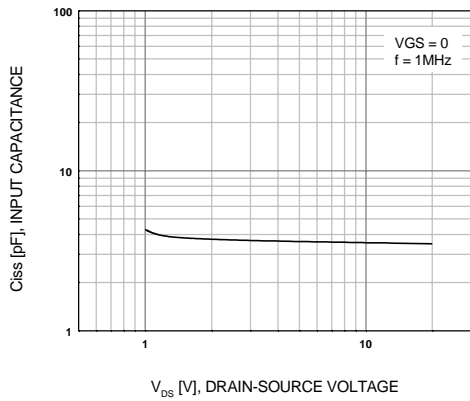

Figure 5. Input Capacitance

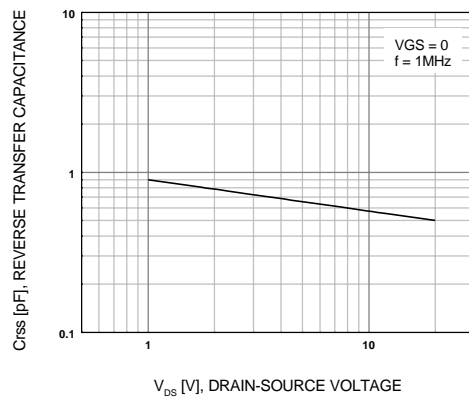

Figure 6. Reverse Transfer Capacitance

Typical Characteristics (Continued)

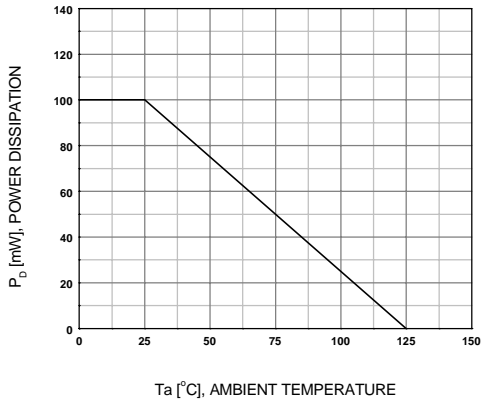

Figure 7. Power Derating

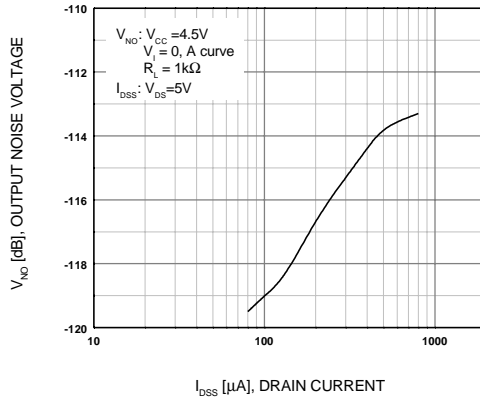

Figure 8. Output Noise Voltage

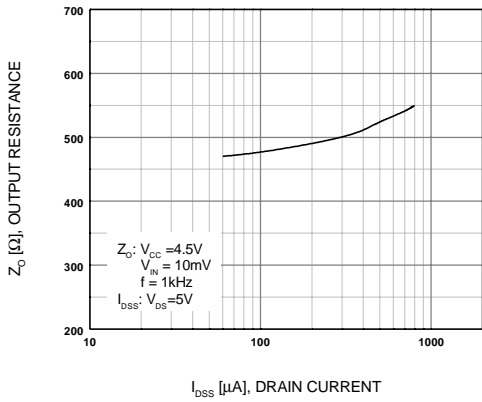

Figure 9. Output Resistance

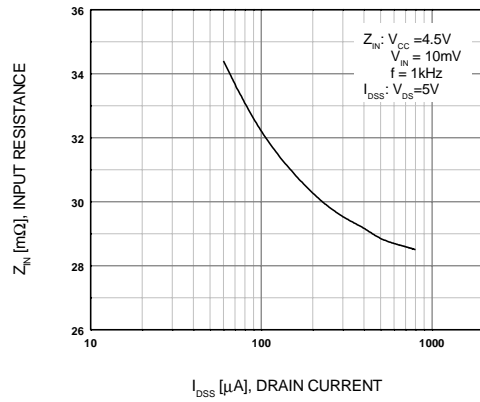

Figure 10. Input Resistance

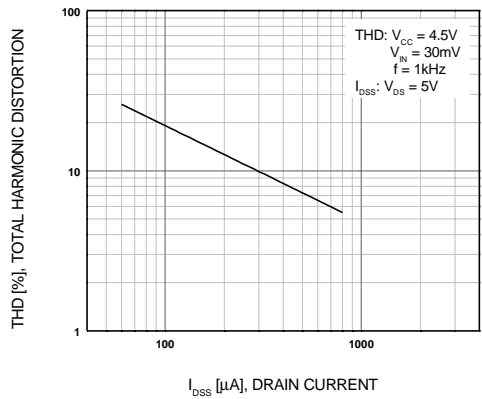

Figure 11. Total Harmonic Distortion vs. Idss

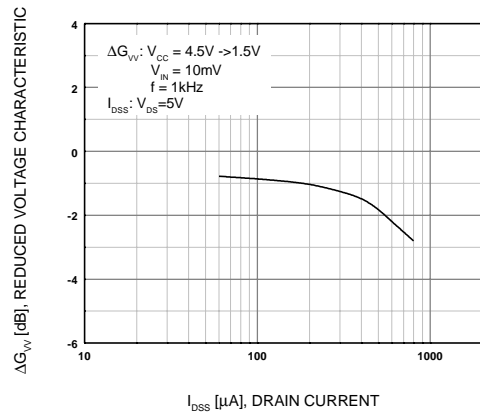

Figure 12. Reduced Voltage Characteristic

Typical Characteristics (Continued)

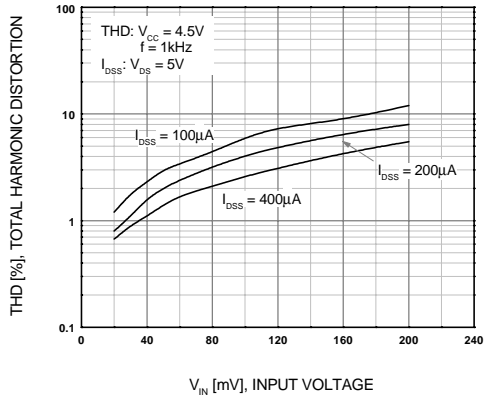

Figure 13. Total Harmonic Distortion vs. V_{IN}

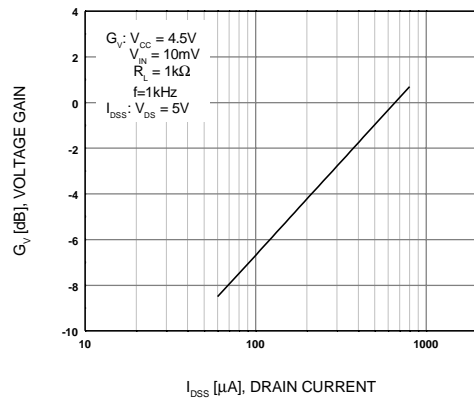
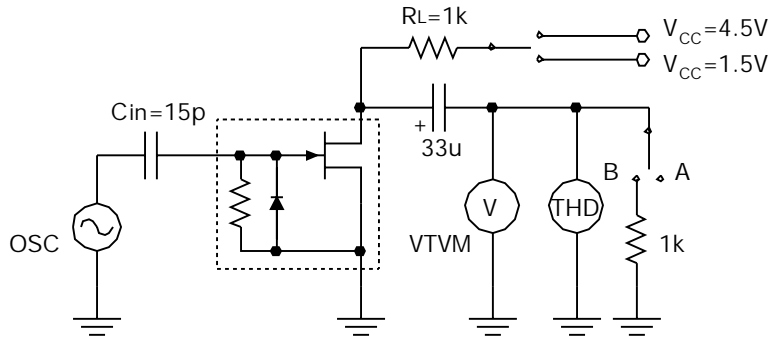

Figure 14. Voltage Gain



Specified Test Circuit

Package Dimensions

SOT-623F

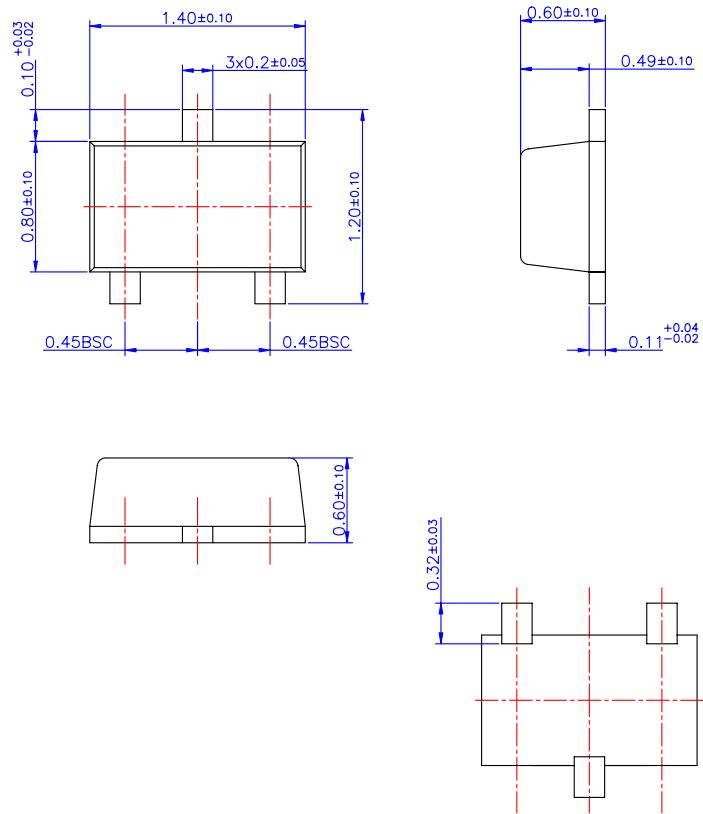

Dimensions in Millimeters

TRADEMARKS

The following are registered and unregistered trademarks Fairchild Semiconductor owns or is authorized to use and is not intended to be an exhaustive list of all such trademarks.

ACE _x ™	FAST®	OPTOLOGIC™	SMART START™	VCX™
Bottomless™	FAST _r ™	OPTOPLANAR™	STAR*POWER™	
CoolFET™	FRFET™	PACMAN™	Stealth™	
CROSSVOLT™	GlobalOptoisolator™	POP™	SuperSOT™-3	
DenseTrench™	GTO™	Power247™	SuperSOT™-6	
DOMET™	HiSeC™	PowerTrench®	SuperSOT™-8	
EcoSPARK™	ISOPLANAR™	QFET™	SyncFET™	
E ² CMOS™	LittleFET™	QS™	TruTranslation™	
EnSigna™	MicroFET™	QT Optoelectronics™	TinyLogic™	
FACT™	MicroPak™	Quiet Series™	UHC™	
FACT Quiet Series™	MICROWIRE™	SLIENT SWITCHER®	UltraFET®	

STAR*POWER is used under license

DISCLAIMER

FAIRCHILD SEMICONDUCTOR RESERVES THE RIGHT TO MAKE CHANGES WITHOUT FURTHER NOTICE TO ANY PRODUCTS HEREIN TO IMPROVE RELIABILITY, FUNCTION OR DESIGN. FAIRCHILD DOES NOT ASSUME ANY LIABILITY ARISING OUT OF THE APPLICATION OR USE OF ANY PRODUCT OR CIRCUIT DESCRIBED HEREIN; NEITHER DOES IT CONVEY ANY LICENSE UNDER ITS PATENT RIGHTS, NOR THE RIGHTS OF OTHERS.

LIFE SUPPORT POLICY

FAIRCHILD'S PRODUCTS ARE NOT AUTHORIZED FOR USE AS CRITICAL COMPONENTS IN LIFE SUPPORT DEVICES OR SYSTEMS WITHOUT THE EXPRESS WRITTEN APPROVAL OF FAIRCHILD SEMICONDUCTOR CORPORATION.

As used herein:

1. Life support devices or systems are devices or systems which, (a) are intended for surgical implant into the body, or (b) support or sustain life, or (c) whose failure to perform when properly used in accordance with instructions for use provided in the labeling, can be reasonably expected to result in significant injury to the user.
2. A critical component is any component of a life support device or system whose failure to perform can be reasonably expected to cause the failure of the life support device or system, or to affect its safety or effectiveness.

PRODUCT STATUS DEFINITIONS

Definition of Terms

Datasheet Identification	Product Status	Definition
Advance Information	Formative or In Design	This datasheet contains the design specifications for product development. Specifications may change in any manner without notice.
Preliminary	First Production	This datasheet contains preliminary data, and supplementary data will be published at a later date. Fairchild Semiconductor reserves the right to make changes at any time without notice in order to improve design.
No Identification Needed	Full Production	This datasheet contains final specifications. Fairchild Semiconductor reserves the right to make changes at any time without notice in order to improve design.
Obsolete	Not In Production	This datasheet contains specifications on a product that has been discontinued by Fairchild semiconductor. The datasheet is printed for reference information only.

Looking for pricing, stock, or lifecycle information?

Click below to explore more details on WIN SOURCE:

- ⊖ [View FJZ594JTF on WIN SOURCE](#)
- ⊖ [Fairchild/ON Semiconductor Information](#)

Optimize Your Supply Chain with WIN SOURCE Solutions

- ✓ Global Sourcing Solution
- ✓ Obsolete Management
- ✓ Cost Control Management
- ✓ Shortage Management
- ✓ Alternative Solution
- ✓ Excess Inventory Management