

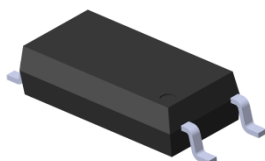

**THE DATASHEET OF
EL1017(TA)-VG**



4 PIN LONG CREEPAGE SOP PHOTOTRANSISTOR PHOTOCOUPLER EL101X-G Series



Features:

- Free halogens compliant
- Current transfer ratio
(CTR: 50~600% at $I_F = 5\text{mA}$, $V_{CE} = 5\text{V}$)
(CTR: 63~320% at $I_F = 10\text{mA}$, $V_{CE} = 5\text{V}$)
- High isolation voltage between input and output ($V_{iso} = 5000\text{ V rms}$)
- Compact 4 Pin SOP with a 2.0 mm profile
- 8mm long creepage distance
- Pb free and RoHS compliant.
- UL approved (No. E214129)
- VDE approved (No. 40028391)
- SEMKO approved
- NEMKO approved
- DEMKO approved
- FIMKO approved

Description

The EL101X-G series devices consist of an infrared emitting diode, optically coupled to a phototransistor detector. Compound use free halogens and Sb_2O_3 . They are packaged in a 4-pin SOP package

Applications

- Programmable controllers
- System appliances, measuring instruments
- Telecommunication equipments
- Home appliances, such as fan heaters, etc.
- Signal transmission between circuits of different potentials and impedances

Schematic

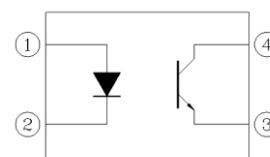

Pin Configuration

1. Anode
2. Cathode
3. Emitter
4. Collector

Absolute Maximum Ratings (Ta=25°C)

	Parameter	Symbol	Rating	Unit
Input	Forward current	I_F	60	mA
	Peak forward current (1us, pulse)	I_{FP}	1.5	A
	Reverse voltage	V_R	6	V
	Power dissipation	P_D	100	mW
Output	Power dissipation	P_C	150	mW
	Collector current	I_C	50	mA
	Collector-Emitter voltage	V_{CEO}	80	V
	Emitter-Collector voltage	V_{ECO}	7	V
	Total Power Dissipation	P_{TOT}	250	mW
	Isolation Voltage* ¹	V_{ISO}	5000	Vrms
	Operating Temperature	T_{OPR}	-55 to 110	°C
	Storage Temperature	T_{STG}	-55 to 125	°C
	Soldering Temperature* ²	T_{SOL}	260	°C

Notes:

*1 AC for 1 minute, R.H.= 40 ~ 60% R.H. In this test, pins 1, 2 are shorted together, and pins 3, 4 are shorted together.

*2 For 10 seconds

Electro-Optical Characteristics (Ta=25°C unless specified otherwise)

Input

Parameter	Symbol	Min.	Typ.	Max.	Unit	Condition
Forward Voltage	V_F	-	1.45	1.5	V	$I_F = 50\text{mA}$
Reverse current	I_R	-	-	10	μA	$V_R = 6\text{V}$
Input capacitance	C_{in}	-	50	-	pF	$V = 0, f = 1\text{kHz}$

Output

Parameter	Symbol	Min	Typ.	Max.	Unit	Condition
Collector-Emitter dark current	I_{CEO}	-	-	100	nA	$V_{CE} = 20\text{V}, I_F = 0\text{mA}$
Collector-Emitter breakdown voltage	BV_{CEO}	80	-	-	V	$I_C = 0.1\text{mA}$
Emitter-Collector breakdown voltage	BV_{ECO}	7	-	-	V	$I_E = 0.1\text{mA}$

Transfer Characteristics

Parameter	Symbol	Min	Typ.	Max.	Unit	Condition
Current Transfer ratio	EL1010	50	-	600	%	$I_F = 5\text{mA}, V_{CE} = 5\text{V}$
	EL1017	80	-	160		
	EL1018	130	-	260		
	EL1019	200	-	400		
	EL1012	63	-	125	%	$I_F = 10\text{mA}, V_{CE} = 5\text{V}$
	EL1013	100	-	200		
	EL1014	160	-	320		
	EL1012	22	-	-		
	EL1013	34	-	-		
	EL1014	56	-	-		
Collector-Emitter saturation voltage	$V_{CE(sat)}$	-	-	0.3	V	$I_F = 10\text{mA}, I_C = 1\text{mA}$
Isolation resistance	R_{IO}	5×10^{10}	-	-	Ω	$V_{IO} = 500\text{Vdc}, 40\sim 60\% \text{ R.H.}$
Floating capacitance	C_{IO}	-	-	1.0	pF	$V_{IO} = 0, f = 1\text{MHz}$

Transfer Characteristics

Parameter	Symbol	Min	Typ.	Max.	Unit	Condition
Turn on time	Ton	-	4	-	μs	V _{CE} = 5V, I _C = 5mA, R _L = 100Ω
Turn off time	Toff	-	3	-		
Rise time	t _r	-	2	18	μs	V _{CE} = 5V, I _C = 5mA, R _L = 100Ω
Fall time	t _f	-	3	18		

* Typical values at T_a = 25°C

Typical Electro-Optical Characteristics Curves

Figure 1. Forward Current vs. Forward Voltage

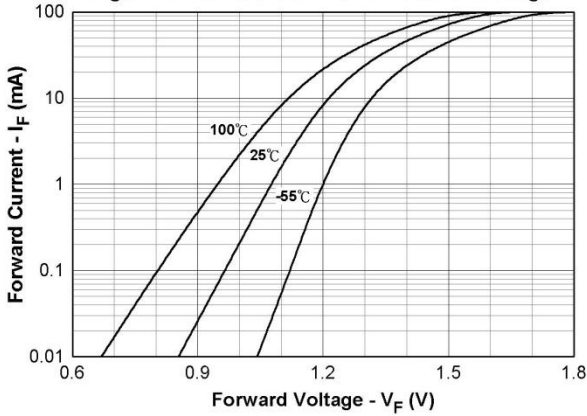

Figure.2 Collector Dark Current vs. Ambient Temperature

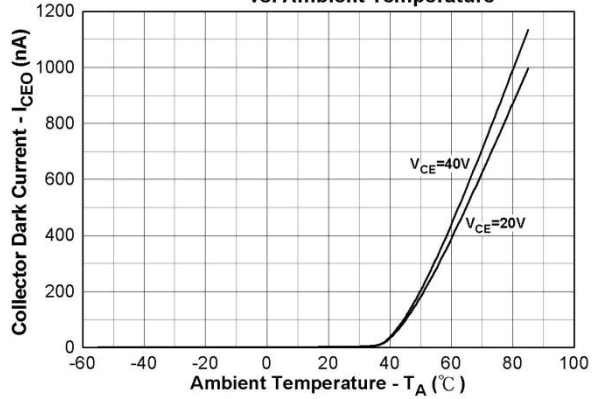

Figure 3. Collector Current vs. Collector Emitter Voltage

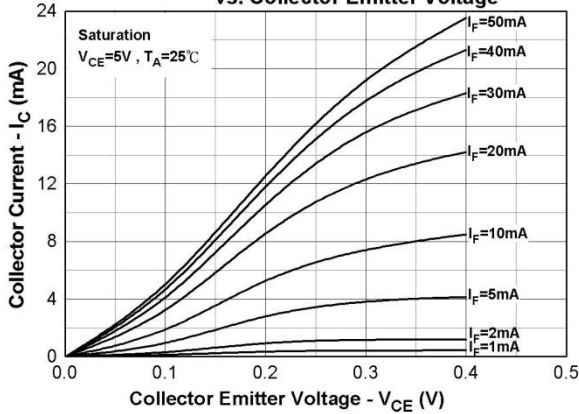

Figure 4. Collector Current vs. Collector Emitter Voltage

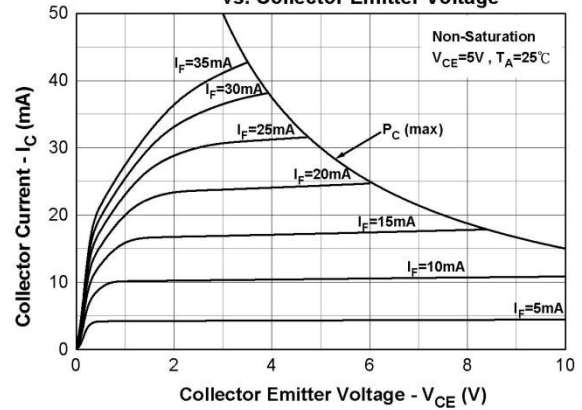

Figure 5. Normalized Collector Current vs. Forward Current

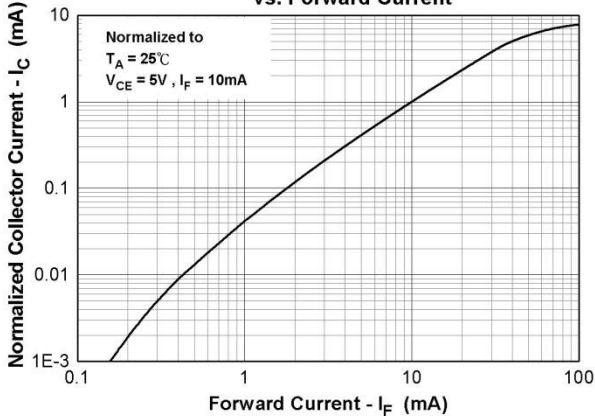

Figure 6. Normalized Current Transfer Ratio vs. Forward Current

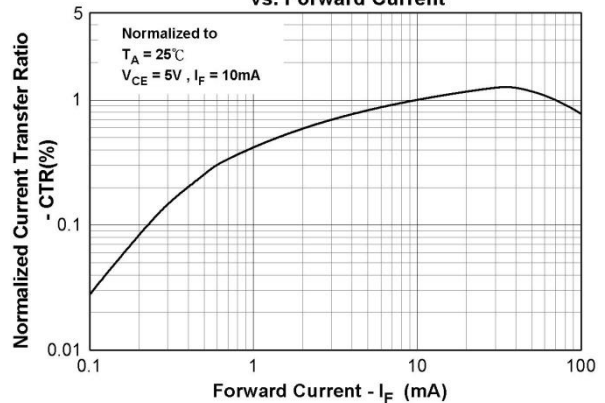

Figure 7. Normalized Current Transfer Ratio vs. Ambient Temperature

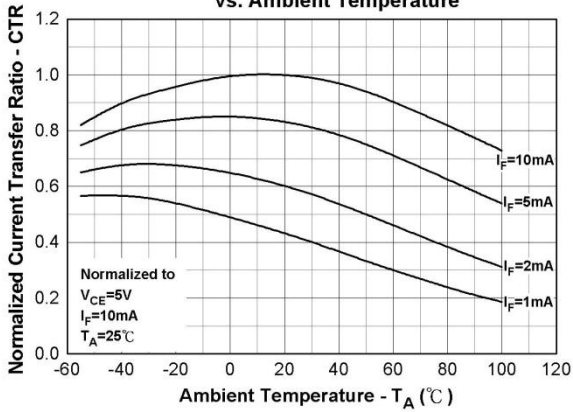

Figure 8. Normalized Current Transfer Ratio vs. Ambient Temperature

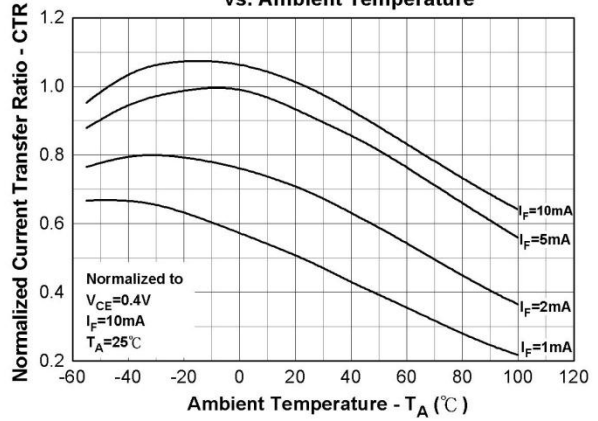

Figure 9. Turn on/off Time vs. Collector Current

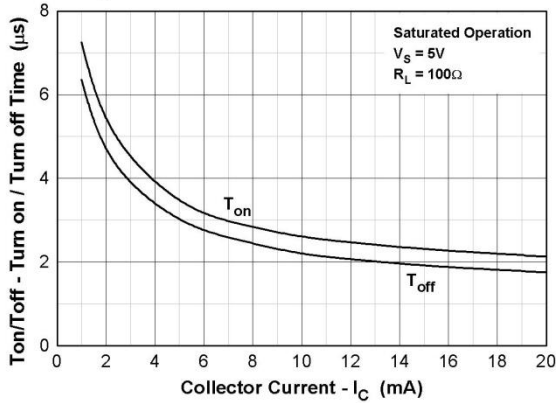

Figure 10. Turn on/off Time vs. Forward Current

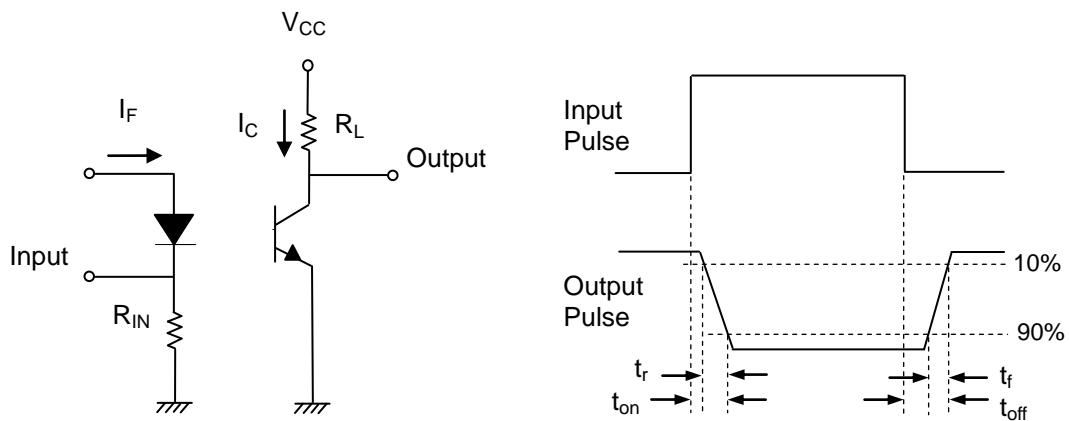
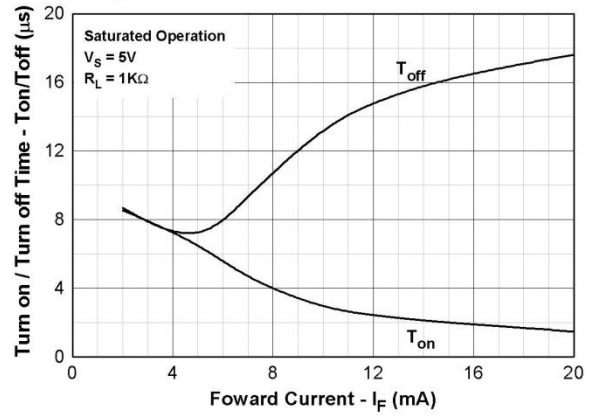

Figure 11. Switching Time Test Circuit & Waveforms

Order Information

Part Number

EL101X(Y)-VG

Note

EL101 = Part No.

X = CTR Rank (0, 2, 3, 4, 7, 8 or 9)

Y = Tape and reel option (TA, TB or none).

V = VDE safety (optional)

G = Halogens free

Option	Description	Packing quantity
None	Standard SMD option	100 units per tube
-V	Standard SMD option + VDE	100 units per tube
(TA)	TA Tape & reel option	3000 units per reel
(TB)	TB Tape & reel option	3000 units per reel
(TA)-V	TA Tape & reel option + VDE	3000 units per reel
(TB)-V	TB Tape & reel option + VDE	3000 units per reel

Package Dimension (Dimensions in mm)

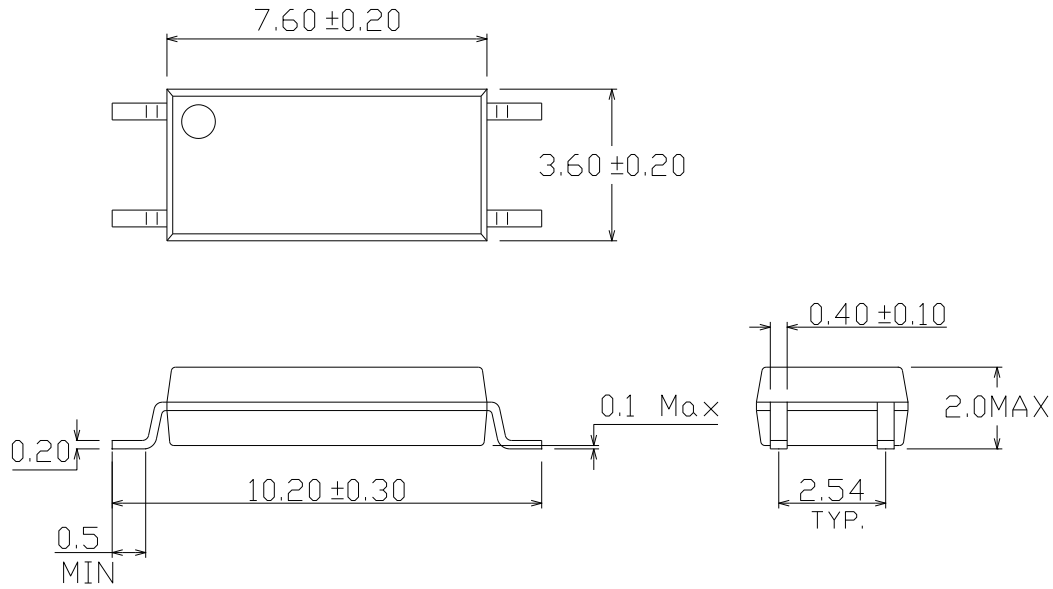

Recommended pad layout for surface mount leadform

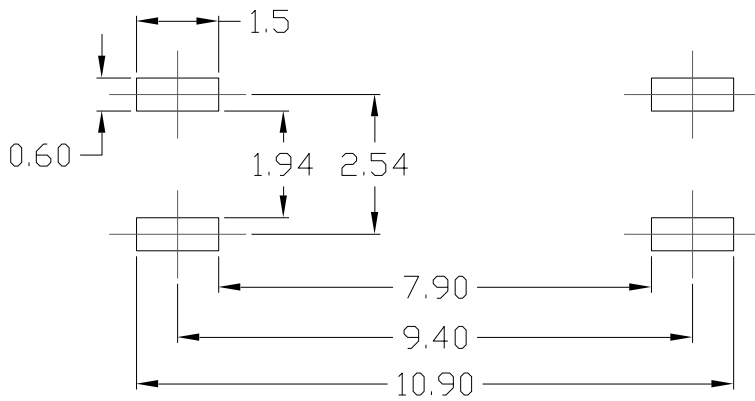

Device Marking

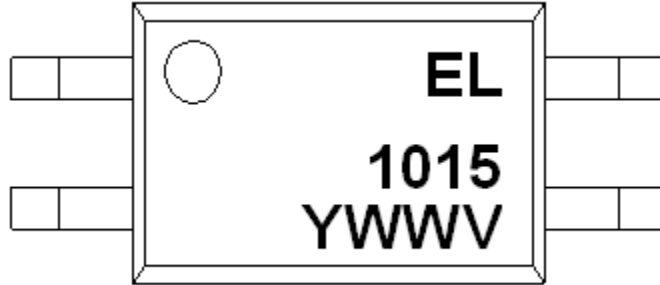

Notes

EL	denotes Everlight
1015	denotes Device Number
Y	denotes 1 digit Year code
WW	denotes 2 digit Week code
V	denotes VDE (optional)

Tape & Reel Packing Specifications

Option TA

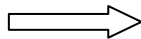
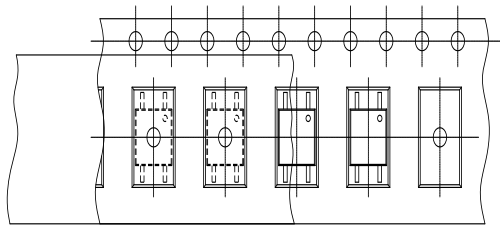

Direction of feed from reel

Option TB

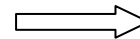
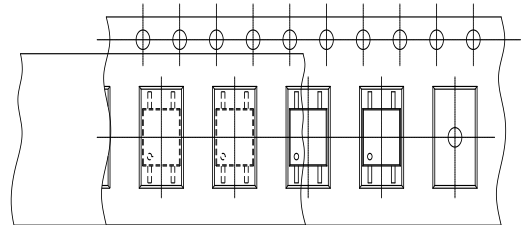

Direction of feed from reel

Tape dimensions

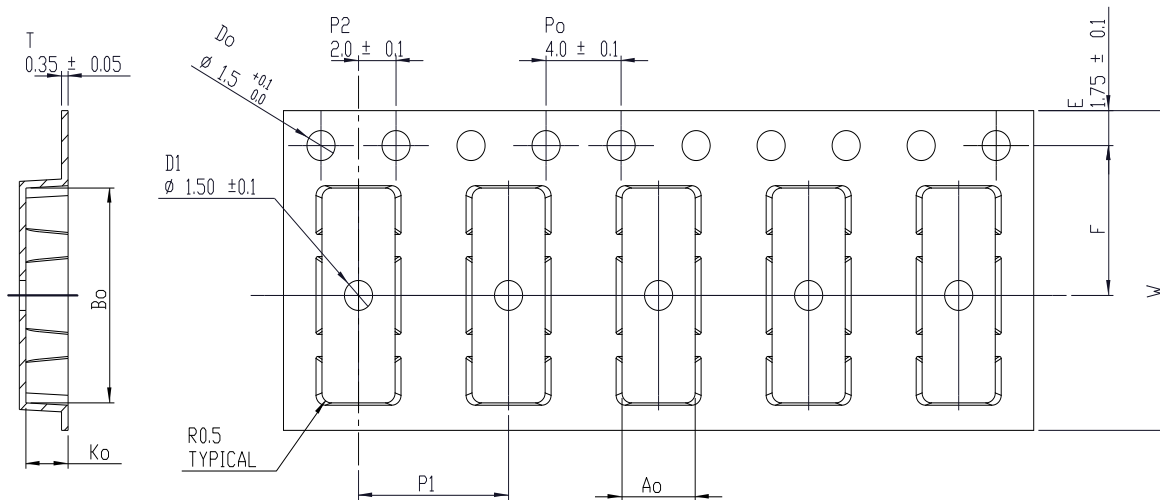

Dimension No.	Ao	Bo	Do	D1	E	F
Dimension (mm)	3.9 ± 0.10	10.75 ± 0.10	1.5 + 0.1/-0	1.5 ± 0.10	1.75± 0.10	7.5 ± 0.10
Dimension No.	Po	P1	P2	T	W	Ko
Dimension (mm)	4.0 ± 0.10	8.0 ± 0.10	2.0 ± 0.10	0.35± 0.05	16.0 ± 0.30	2.25 ± 0.10

Precautions for Use

1. Soldering Condition

1.1 (A) Maximum Body Case Temperature Profile for evaluation of Reflow Profile

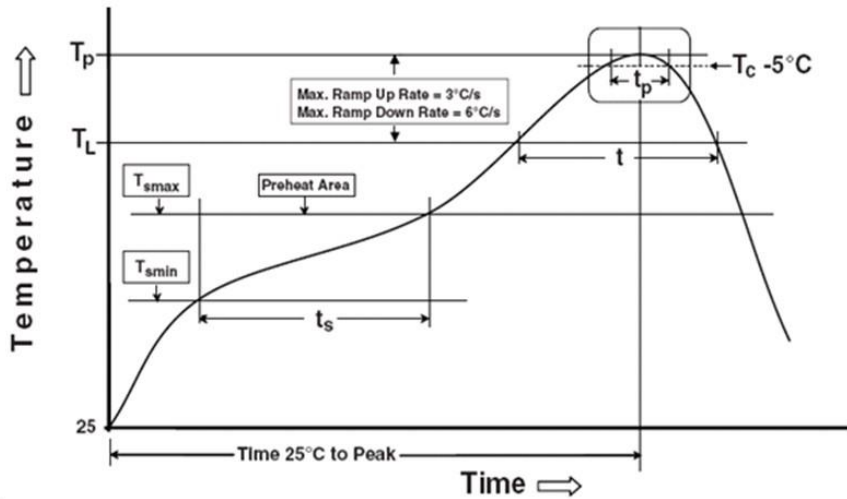

Note:

Reference: IPC/JEDEC J-STD-020D

Preheat

Temperature min (T_{smin})	150 °C
Temperature max (T_{smax})	200°C
Time (T_{smin} to T_{smax}) (t_s)	60-120 seconds
Average ramp-up rate (T_{smax} to T_p)	3 °C/second max

Other

Liquidus Temperature (T_L)	217 °C
Time above Liquidus Temperature (t_L)	60-100 sec
Peak Temperature (T_p)	260°C
Time within 5 °C of Actual Peak Temperature: $T_p - 5^\circ\text{C}$	30 s
Ramp- Down Rate from Peak Temperature	6°C /second max.
Time 25°C to peak temperature	8 minutes max.
Reflow times	3 times

DISCLAIMER

1. Above specification may be changed without notice. EVERLIGHT will reserve authority on material change for above specification.
2. When using this product, please observe the absolute maximum ratings and the instructions for using outlined in these specification sheets. EVERLIGHT assumes no responsibility for any damage resulting from use of the product which does not comply with the absolute maximum ratings and the instructions included in these specification sheets.
3. These specification sheets include materials protected under copyright of EVERLIGHT corporation. Please don't reproduce or cause anyone to reproduce them without EVERLIGHT's consent.

Looking for pricing, stock, or lifecycle information?

Click below to explore more details on WIN SOURCE:

- ⊖ [View EL1017\(TA\)-VG on WIN SOURCE](#)
- ⊖ [Everlight Electronics Co Ltd Information](#)

Optimize Your Supply Chain with WIN SOURCE Solutions

- ✓ Global Sourcing Solution
- ✓ Obsolete Management
- ✓ Cost Control Management
- ✓ Shortage Management
- ✓ Alternative Solution
- ✓ Excess Inventory Management