



**THE DATASHEET OF
PMEG3005EL,315**



PMEG3005EB; PMEG3005EL

0.5 A very low V_F MEGA Schottky barrier rectifiers

Rev. 01 — 29 November 2006

Product data sheet

1. Product profile

1.1 General description

Planar Maximum Efficiency General Application (MEGA) Schottky barrier rectifiers with an integrated guard ring for stress protection, encapsulated in ultra small Surface-Mounted Device (SMD) plastic packages.

Table 1. Product overview

Type number	Package		Configuration
	Nexperia	JEITA	
PMEG3005EB	SOD523	SC-79	single
PMEG3005EL	SOD882	-	single

1.2 Features

- Forward current: $I_F \leq 0.5$ A
- Reverse voltage: $V_R \leq 30$ V
- Very low forward voltage
- Ultra small SMD plastic packages

1.3 Applications

- Low voltage rectification
- High efficiency DC-to-DC conversion
- Switch mode power supply
- Reverse polarity protection
- Low power consumption applications

1.4 Quick reference data

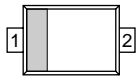

Table 2. Quick reference data

Symbol	Parameter	Conditions	Min	Typ	Max	Unit
I_F	forward current	$T_{sp} \leq 55$ °C	-	-	0.5	A
V_R	reverse voltage		-	-	30	V
V_F	forward voltage	$I_F = 500$ mA	[1] -	430	500	mV

[1] Pulse test: $t_p \leq 300$ μ s; $\delta \leq 0.02$.

2. Pinning information

Table 3. Pinning

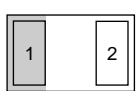
Pin	Description	Simplified outline	Symbol
SOD523			
1	cathode	[1]	 <i>sym001</i>
2	anode		
SOD882			
1	cathode	[1]	 <i>sym001</i>
2	anode	 Transparent top view	

[1] The marking bar indicates the cathode.

3. Ordering information

Table 4. Ordering information

Type number	Package		
	Name	Description	Version
PMEG3005EB	SC-79	plastic surface-mounted package; 2 leads	SOD523
PMEG3005EL	-	leadless ultra small plastic package; 2 terminals; body 1.0 × 0.6 × 0.5 mm	SOD882

4. Marking

Table 5. Marking codes

Type number	Marking code
PMEG3005EB	KB
PMEG3005EL	AM

5. Limiting values

Table 6. Limiting values

In accordance with the Absolute Maximum Rating System (IEC 60134).

Symbol	Parameter	Conditions	Min	Max	Unit
V_R	reverse voltage		-	30	V
I_F	forward current	$T_{sp} \leq 55\text{ °C}$	-	0.5	A
I_{FRM}	repetitive peak forward current	$t_p \leq 1\text{ ms};$ $\delta \leq 0.25$	-	1	A
I_{FSM}	non-repetitive peak forward current	square wave; $t_p = 8\text{ ms}$	-	3	A
P_{tot}	total power dissipation	$T_{amb} \leq 25\text{ °C}$	[1]		
	PMEG3005EB		-	310	mW
	PMEG3005EL		-	250	mW
T_j	junction temperature		-	150	°C
T_{amb}	ambient temperature		-65	+150	°C
T_{stg}	storage temperature		-65	+150	°C

[1] Device mounted on an FR4 Printed-Circuit Board (PCB), single-sided copper, tin-plated and standard footprint.

6. Thermal characteristics

Table 7. Thermal characteristics

Symbol	Parameter	Conditions	Min	Typ	Max	Unit
$R_{th(j-a)}$	thermal resistance from junction to ambient	in free air	[1][2]			
	PMEG3005EB		-	-	400	K/W
	PMEG3005EL		-	-	500	K/W
$R_{th(j-sp)}$	thermal resistance from junction to solder point		[3]			
	PMEG3005EB		-	-	75	K/W

[1] For Schottky barrier diodes thermal runaway has to be considered, as in some applications the reverse power losses P_R are a significant part of the total power losses.

[2] Device mounted on an FR4 PCB, single-sided copper, tin-plated and standard footprint.

[3] Soldering point of cathode tab.

7. Characteristics

Table 8. Characteristics

$T_{amb} = 25^\circ\text{C}$ unless otherwise specified.

Symbol	Parameter	Conditions	Min	Typ	Max	Unit
V_F	forward voltage		[1]			
		$I_F = 0.1\text{ mA}$	-	90	180	mV
		$I_F = 1\text{ mA}$	-	150	200	mV
		$I_F = 10\text{ mA}$	-	210	270	mV
		$I_F = 100\text{ mA}$	-	295	360	mV
I_R	reverse current	$V_R = 10\text{ V}$	-	15	200	μA
		$V_R = 30\text{ V}$	-	70	500	μA
C_d	diode capacitance	$V_R = 1\text{ V}; f = 1\text{ MHz}$	-	24	30	pF

[1] Pulse test: $t_p \leq 300\ \mu\text{s}$; $\delta \leq 0.02$.

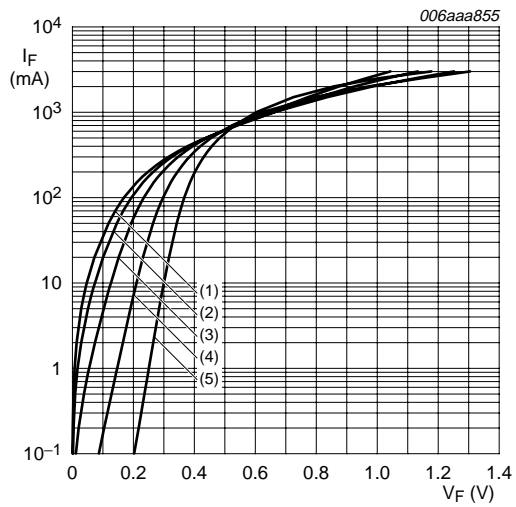

- (1) $T_{amb} = 150\text{ }^{\circ}\text{C}$
- (2) $T_{amb} = 125\text{ }^{\circ}\text{C}$
- (3) $T_{amb} = 85\text{ }^{\circ}\text{C}$
- (4) $T_{amb} = 25\text{ }^{\circ}\text{C}$
- (5) $T_{amb} = -40\text{ }^{\circ}\text{C}$

Fig 1. Forward current as a function of forward voltage; typical values

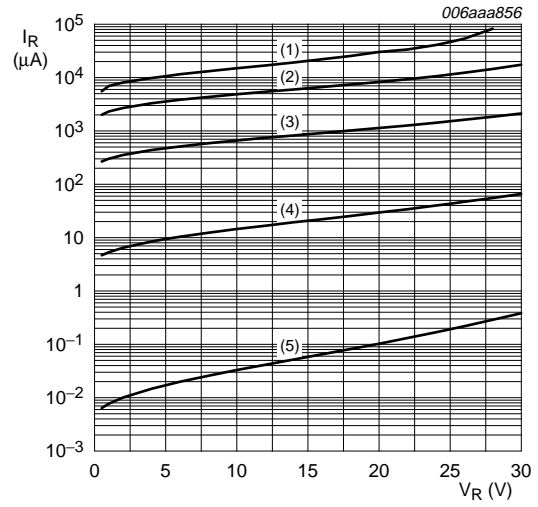

- (1) $T_{amb} = 150\text{ }^{\circ}\text{C}$
- (2) $T_{amb} = 125\text{ }^{\circ}\text{C}$
- (3) $T_{amb} = 85\text{ }^{\circ}\text{C}$
- (4) $T_{amb} = 25\text{ }^{\circ}\text{C}$
- (5) $T_{amb} = -40\text{ }^{\circ}\text{C}$

Fig 2. Reverse current as a function of reverse voltage; typical values

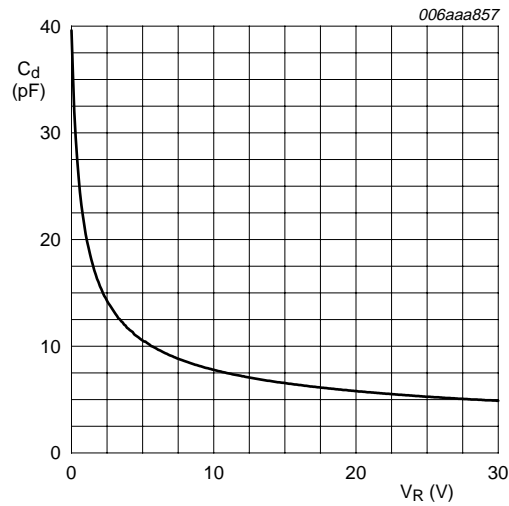

$f = 1\text{ MHz}; T_{amb} = 25\text{ }^{\circ}\text{C}$

Fig 3. Diode capacitance as a function of reverse voltage; typical values

8. Test information

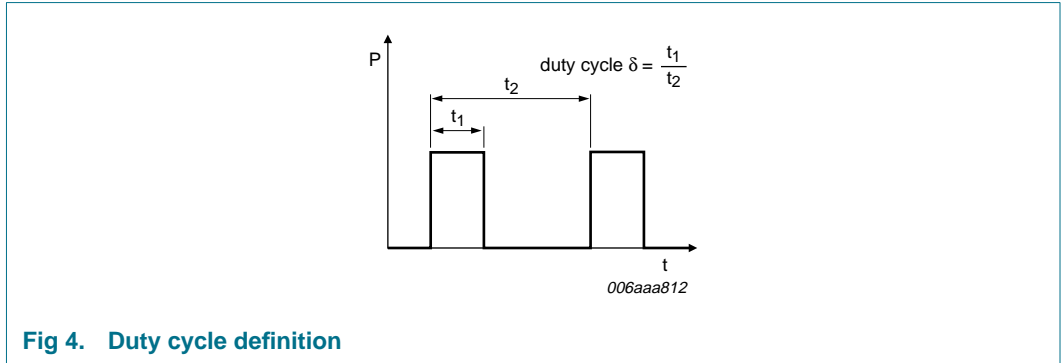

9. Package outline

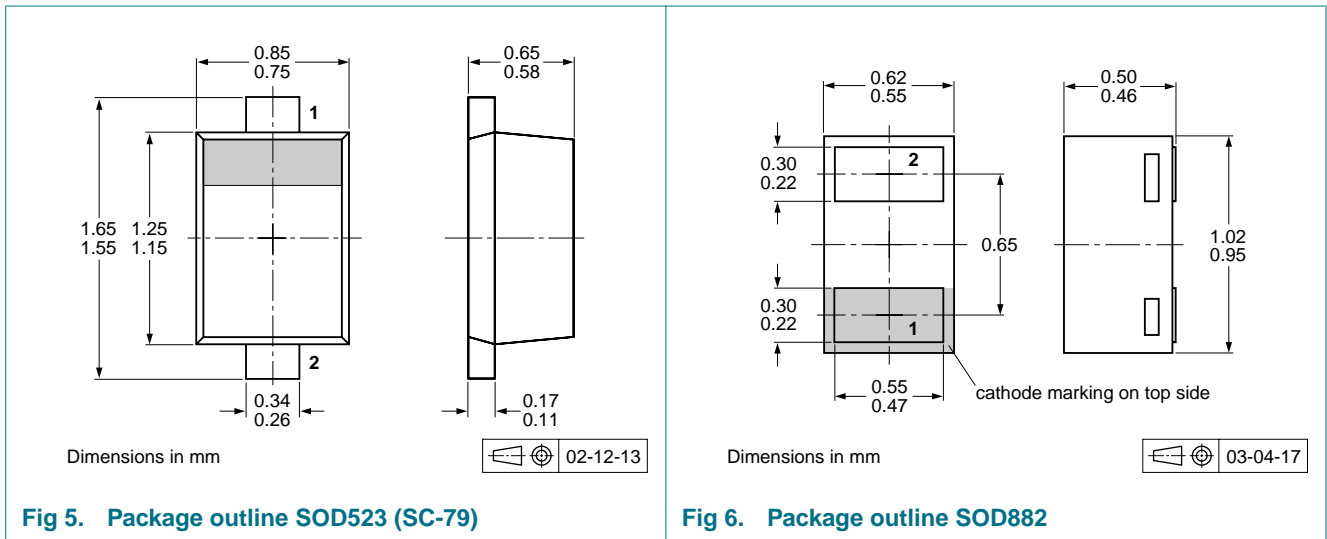

10. Packing information

Table 9. Packing methods

The indicated -xxx are the last three digits of the 12NC ordering code.^[1]

Type number	Package	Description	Packing quantity		
			3000	8000	10000
PMEG3005EB	SOD523	2 mm pitch, 8 mm tape and reel	-	-315	-
		4 mm pitch, 8 mm tape and reel	-115	-	-135
PMEG3005EL	SOD882	2 mm pitch, 8 mm tape and reel	-	-	-315

[1] For further information and the availability of packing methods, see [Section 14](#).

11. Soldering

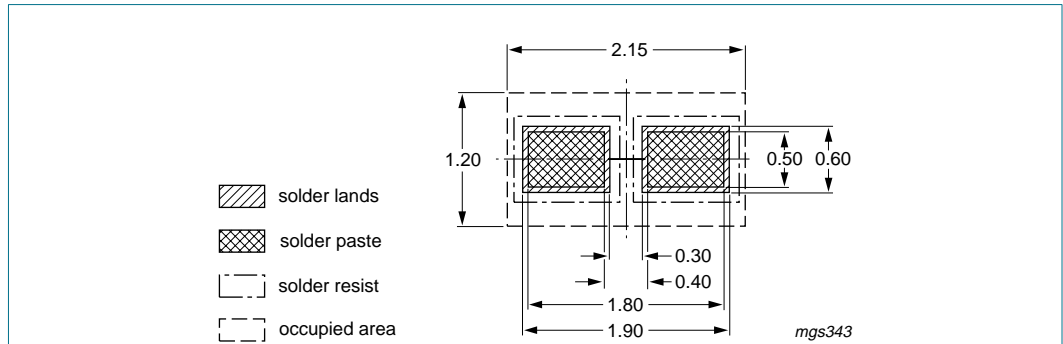

Reflow soldering is the only recommended soldering method.
 Dimensions in mm

Fig 7. Reflow soldering footprint SOD523 (SC-79)

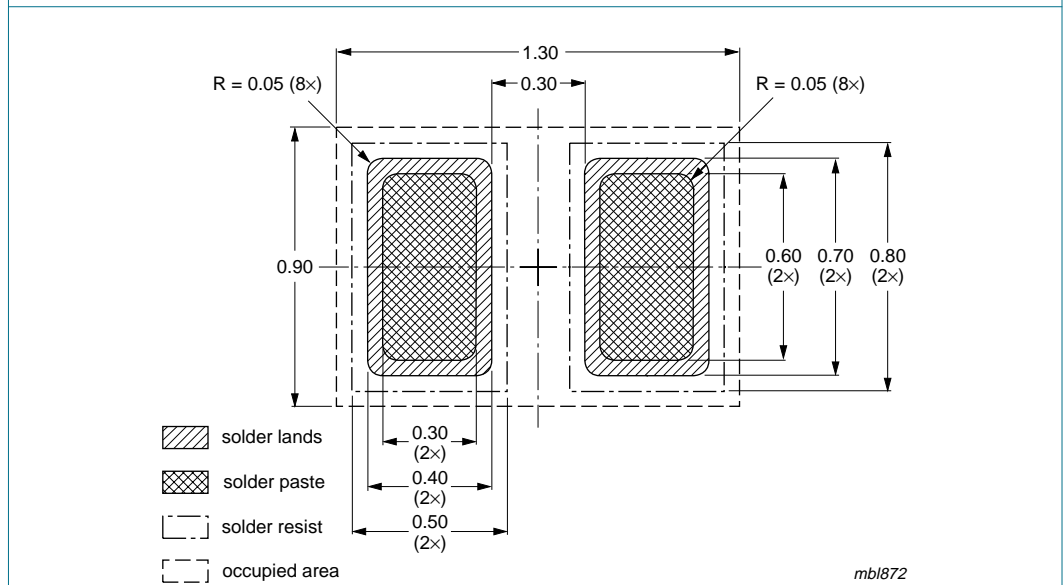

Reflow soldering is the only recommended soldering method.
 Dimensions in mm

Fig 8. Reflow soldering footprint SOD882

12. Revision history

Table 10. Revision history

Document ID	Release date	Data sheet status	Change notice	Supersedes
PMEG3005EB_PMEG3005EL_1	20061129	Product data sheet	-	-

13. Legal information

13.1 Data sheet status

Document status ^{[1][2]}	Product status ^[3]	Definition
Objective [short] data sheet	Development	This document contains data from the objective specification for product development.
Preliminary [short] data sheet	Qualification	This document contains data from the preliminary specification.
Product [short] data sheet	Production	This document contains the product specification.

[1] Please consult the most recently issued document before initiating or completing a design.

[2] The term 'short data sheet' is explained in section "Definitions".

[3] The product status of device(s) described in this document may have changed since this document was published and may differ in case of multiple devices. The latest product status information is available on the Internet at URL <http://www.nexperia.com>.

13.2 Definitions

Draft — The document is a draft version only. The content is still under internal review and subject to formal approval, which may result in modifications or additions. Nexperia does not give any representations or warranties as to the accuracy or completeness of information included herein and shall have no liability for the consequences of use of such information.

Short data sheet — A short data sheet is an extract from a full data sheet with the same product type number(s) and title. A short data sheet is intended for quick reference only and should not be relied upon to contain detailed and full information. For detailed and full information see the relevant full data sheet, which is available on request via the local Nexperia sales office. In case of any inconsistency or conflict with the short data sheet, the full data sheet shall prevail.

13.3 Disclaimers

General — Information in this document is believed to be accurate and reliable. However, Nexperia does not give any representations or warranties, expressed or implied, as to the accuracy or completeness of such information and shall have no liability for the consequences of use of such information.

Right to make changes — Nexperia reserves the right to make changes to information published in this document, including without limitation specifications and product descriptions, at any time and without notice. This document supersedes and replaces all information supplied prior to the publication hereof.

Suitability for use — Nexperia products are not designed, authorized or warranted to be suitable for use in medical, military, aircraft, space or life support equipment, nor in applications where failure or

malfunction of a Nexperia product can reasonably be expected to result in personal injury, death or severe property or environmental damage. Nexperia accepts no liability for inclusion and/or use of Nexperia products in such equipment or applications and therefore such inclusion and/or use is at the customer's own risk.

Applications — Applications that are described herein for any of these products are for illustrative purposes only. Nexperia makes no representation or warranty that such applications will be suitable for the specified use without further testing or modification.

Limiting values — Stress above one or more limiting values (as defined in the Absolute Maximum Ratings System of IEC 60134) may cause permanent damage to the device. Limiting values are stress ratings only and operation of the device at these or any other conditions above those given in the Characteristics sections of this document is not implied. Exposure to limiting values for extended periods may affect device reliability.

Terms and conditions of sale — Nexperia products are sold subject to the general terms and conditions of commercial sale, as published at <http://www.nexperia.com/profile/terms>, including those pertaining to warranty, intellectual property rights infringement and limitation of liability, unless explicitly otherwise agreed to in writing by Nexperia. In case of any inconsistency or conflict between information in this document and such terms and conditions, the latter will prevail.

No offer to sell or license — Nothing in this document may be interpreted or construed as an offer to sell products that is open for acceptance or the grant, conveyance or implication of any license under any copyrights, patents or other industrial or intellectual property rights.

13.4 Trademarks

Notice: All referenced brands, product names, service names and trademarks are the property of their respective owners.

14. Contact information

For additional information, please visit: <http://www.nexperia.com>



For sales office addresses, send an email to: salesaddresses@nexperia.com

15. Contents

1	Product profile	1
1.1	General description	1
1.2	Features	1
1.3	Applications	1
1.4	Quick reference data	1
2	Pinning information	2
3	Ordering information	2
4	Marking	2
5	Limiting values	3
6	Thermal characteristics	3
7	Characteristics	4
8	Test information	6
9	Package outline	6
10	Packing information	6
11	Soldering	7
12	Revision history	8
13	Legal information	9
13.1	Data sheet status	9
13.2	Definitions	9
13.3	Disclaimers	9
13.4	Trademarks	9
14	Contact information	9
15	Contents	10

Looking for pricing, stock, or lifecycle information?

Click below to explore more details on WIN SOURCE:

-  [View PMEG3005EL,315 on WIN SOURCE](#)
-  [Nexperia USA Inc. Information](#)

Optimize Your Supply Chain with WIN SOURCE Solutions

-  Global Sourcing Solution
-  Obsolete Management
-  Cost Control Management
-  Shortage Management
-  Alternative Solution
-  Excess Inventory Management