



**THE DATASHEET OF
ZXMS6002GTA**



**60V N-CHANNEL SELF PROTECTED ENHANCEMENT MODE
IntelliFET MOSFET WITH STATUS INDICATION**
Product Summary

- Continuous Drain Source Voltage $V_{DS} = 60V$
- On-State Resistance: 500m Ω
- Nominal Load Current ($V_{IN} = 5V$): 1.4A
- Clamping Energy: 550mJ

Description

The ZXMS6002G is a self-protected low-side IntelliFET™ MOSFET. It features monolithic overtemperature, overcurrent, overvoltage (active clamp) and ESD-protected logic level functionality.

It is intended as a general purpose switch, with status indication and programmable current limit.

Applications

- Especially Suited for Loads with a High In-Rush Current Such as Lamps and Motors
- All types of resistive, inductive and capacitive loads in switching applications
- μC Compatible Power Switch for 12V and 24V DC Applications
- Replaces electromechanical relays and discrete circuits
- Linear mode capability - the current-limiting protection circuitry is designed to de-activate at low V_{DS} , in order not to compromise the load current during normal operation. The design max. DC operating current is therefore determined by the thermal capability of the package/board combination, rather than by the protection circuitry.

Note: This does not compromise the product's ability to self-protect during short-circuit load conditions.

- Status pin voltage reflects the gate drive being applied internally to the power MOSFET
- With $V_{IN} = 5V$:
 - Status Voltage: 5V indicates normal operation
 - Status Voltage: 2V to 3V indicates that the device is in current-limiting mode
 - Status Voltage: <1V indicates that the device is in thermal shutdown

Features and Benefits

- Status Pin (Analog Status Indication)
- Logic Level Input
- Short Circuit Protection with Auto Restart
- Overvoltage Protection (Active Clamp)
- Thermal Shutdown with Auto Restart
- Overcurrent Protection
- Input Protection (ESD)
- Load Dump Protection (Actively Protects Load)
- High Continuous Current Rating
- **Lead-Free Finish; RoHS Compliant (Notes 1 & 2)**
- **Halogen and Antimony Free. "Green" Device (Note 3)**

Mechanical Data

- Case: SOT223
- Case Material: Molded Plastic, "Green" Molding Compound. UL Flammability Classification Rating 94V-0
- Moisture Sensitivity: Level 1 per J-STD-020
- Terminals: Matte Tin Finish⁽³⁾
- Weight: 0.112 grams (Approximate)

SOT223 (Type DN)

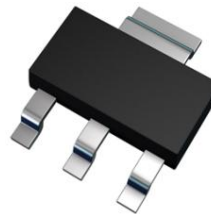

Top View

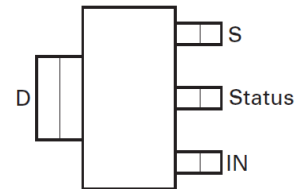

 Top View
Pin Out

Ordering Information (Note 4)

Part Number	Marking	Reel Size (inches)	Tape Width (mm)	Quantity per Reel
ZXMS6002GTA	ZXMS6002	7	12	1,000 Units

- Notes:
1. EU Directive 2002/95/EC (RoHS), 2011/65/EU (RoHS 2) & 2015/863/EU (RoHS 3) compliant. All applicable RoHS exemptions applied.
 2. See <https://www.diodes.com/quality/lead-free/> for more information about Diodes Incorporated's definitions of Halogen- and Antimony-free, "Green" and Lead-free.
 3. Halogen- and Antimony-free "Green" products are defined as those which contain <900ppm bromine, <900ppm chlorine (<1500ppm total Br + Cl) and <1000ppm antimony compounds.
 4. For packaging details, go to our website at <https://www.diodes.com/design/support/packaging/diodes-packaging/>.

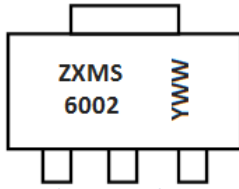
Marking Information



ZXMS6002 = Product Type Marking Code
 YWW = Date Code Marking
 Y or \bar{Y} = Last Digit of Year (ex: 9 = 2019)
 WW or $\bar{W}W$ = Week Code (01 to 53)

Functional Block Diagram

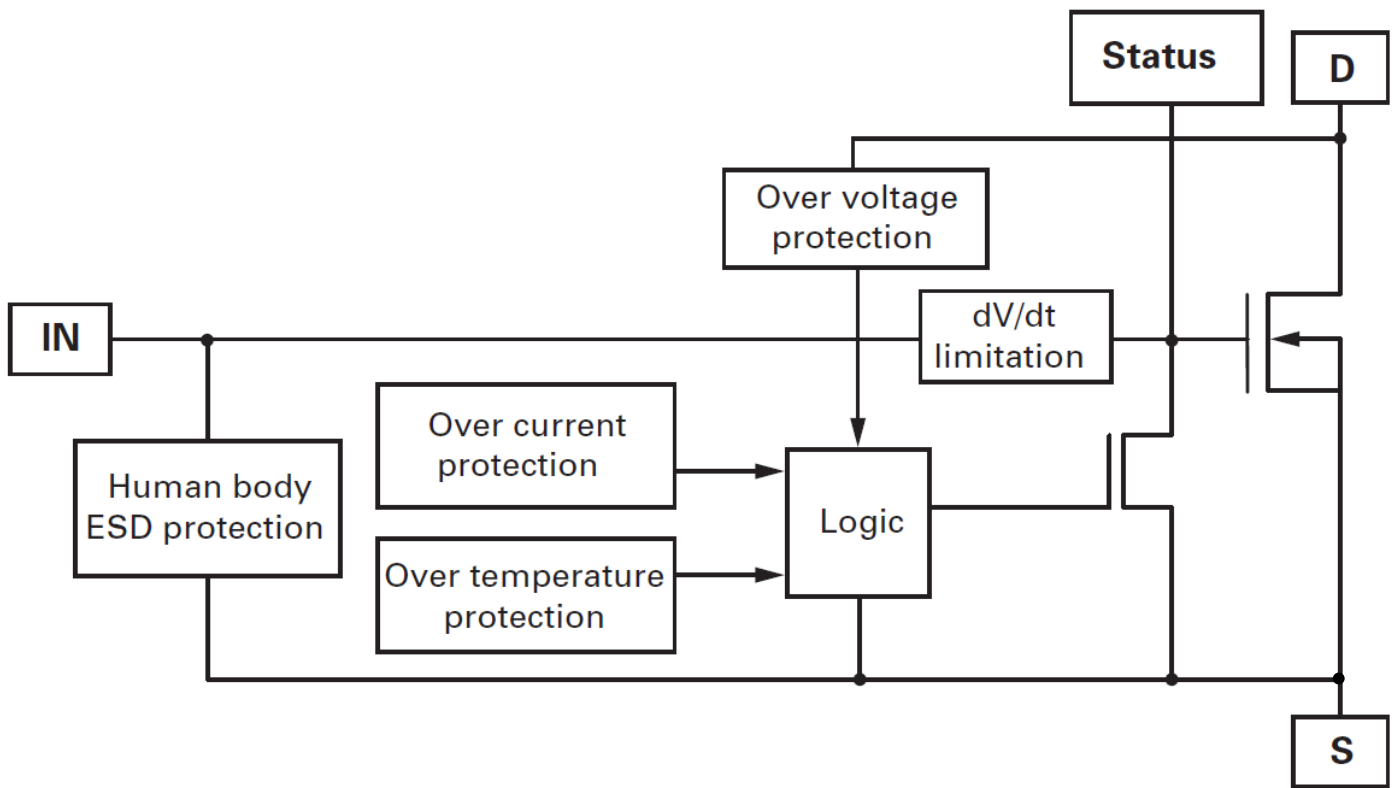

Absolute Maximum Ratings (@T_A = +25°C, unless otherwise stated.)

Parameter	Symbol	Limit	Unit
Continuous Drain-Source Voltage	V _{DS}	60	V
Drain-Source Voltage for Short Circuit Protection V _{IN} = 5V	V _{DS(SC)}	36	V
Drain-Source Voltage for Short Circuit Protection V _{IN} = 10V	V _{DS(SC)}	20	V
Continuous Input Voltage	V _{IN}	-0.2 to +10	V
Peak Input Voltage	V _{IN}	-0.2 to +20	V
Operating Temperature Range	T _J	-40 to +150	°C
Storage Temperature Range	T _{STG}	-55 to +150	°C
Power Dissipation at T _A = +25°C (Note 5)	P _D	2.5	W
Continuous Drain Current @ V _{IN} = 10V; T _A = +25°C (Note 5)	I _D	1.6	A
Continuous Drain Current @ V _{IN} = 5V; T _A = +25°C (Note 5)	I _D	1.4	A
Continuous Source Current (Body Diode) (Note 5)	I _S	3	A
Pulsed Source Current (Body Diode) (Note 6)	I _S	4.7	A
Unclamped Single Pulse Inductive Energy	E _{AS}	550	mJ
Load Dump Protection	V _{LOADDUMP}	80	V
Electrostatic Discharge (Human Body Model)	V _{ESD}	4,000	V
DIN Humidity Category, DIN 40 040	—	E	—
IEC Climatic Category, DIN IEC 68-1	—	40/150/56	—

Thermal Resistance (@T_A = +25°C, unless otherwise stated.)

Parameter	Symbol	Value	Unit
Junction to Ambient (Note 5)	R _{θJA}	50	°C/W
Junction to Ambient (Note 6)	R _{θJA}	28	°C/W

Notes: 5. For a device surface mounted on 50mm × 50mm × 1.6mm FR-4 board with a high coverage of single sided 2oz weight copper.
6. For a device surface mounted on FR-4 board and measured at t<=10s.

Thermal Characteristics

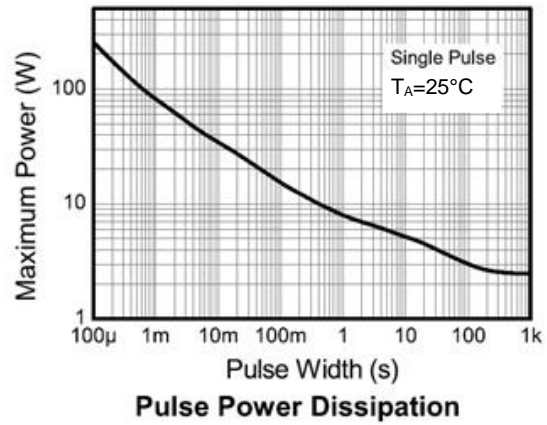
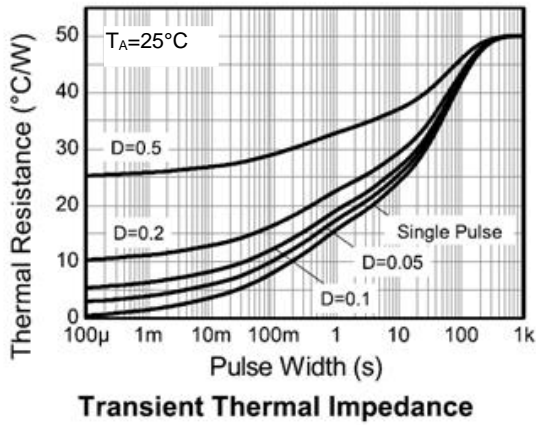
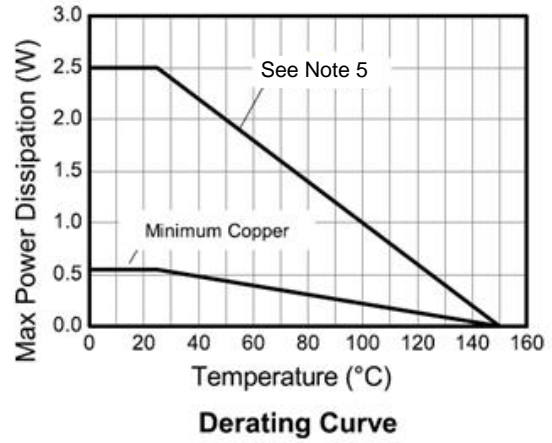
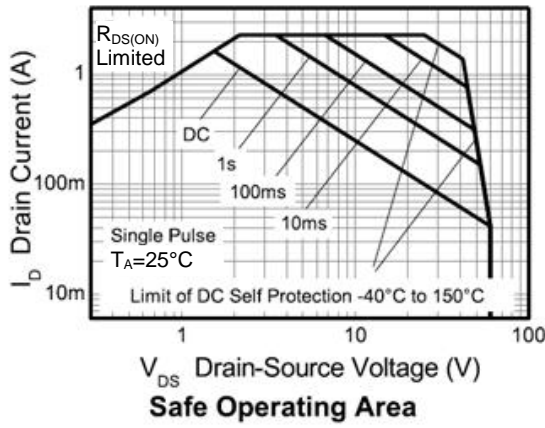

Electrical Characteristics (@T_A = +25°C, unless otherwise stated.)

Parameter	Symbol	Min	Typ	Max	Unit	Conditions
Static Characteristics						
Drain-Source Clamp Voltage	V _{DS(AZ)}	60	70	75	V	I _D = 10mA
Off State Drain Current	I _{DSS}	—	0.1	3	μA	V _{DS} = 12V, V _{IN} = 0V
Off State Drain Current	I _{DSS}	—	3	15	μA	V _{DS} = 32V, V _{IN} = 0V
Input Threshold Voltage (Note 7)	V _{IN(TH)}	1	2.1	—	V	V _{DS} = V _{GS} , I _D = 1mA
Input Current	I _{IN}	—	0.7	1.2	mA	V _{IN} = 5V
Input Current	I _{IN}	—	1.5	2.7	mA	V _{IN} = 7V
Input Current	I _{IN}	—	4	7	mA	V _{IN} = 10V
Static Drain-Source On-State Resistance	R _{DS(ON)}	—	520	675	mΩ	V _{IN} = 5V, I _D = 0.7A
Static Drain-Source On-State Resistance	R _{DS(ON)}	—	385	500	mΩ	V _{IN} = 10V, I _D = 0.7A
Current Limit (Note 8)	I _{D(LIM)}	0.7	1.0	1.5	A	V _{IN} = 5V, V _{DS} > 5V
Current Limit (Note 8)	I _{D(LIM)}	1	1.8	2.3	A	V _{IN} = 10V, V _{DS} > 5V
Dynamic Characteristics						
Turn-On Time (V _{IN} to 90% I _D)	t _{ON}	—	3	—	μs	R _L = 22Ω, V _{IN} = 0 to 10V, V _{DD} = 12V
Turn-Off Time (V _{IN} to 90% I _D)	t _{OFF}	—	13	—	μs	R _L = 22Ω, V _{IN} = 10V to 0V, V _{DD} = 12V
Slew Rate On (70 to 50% V _{DD})	dV _{DS} /dt _{ON}	—	8	—	V/μs	R _L = 22Ω, V _{IN} = 0 to 10V, V _{DD} = 12V
Slew Rate Off (50 to 70% V _{DD})	dV _{DS} /dt _{ON}	—	3.2	—	V/μs	R _L = 22Ω, V _{IN} = 10V to 0V, V _{DD} = 12V

Notes: 7. Protection features may operate outside spec for V_{IN} < 4.5V.
8. The drain current is limited to a reduced value when V_{DS} exceeds a safe level.

Electrical Characteristics (continued) (@T_A = +25°C, unless otherwise specified.)

Parameter	Symbol	Min	Typ	Max	Unit	Conditions
Protection Functions (Note 9)						
Required Input Voltage for Overtemperature Protection	V _{PROT}	4.5	—	—	V	—
Thermal Overload Trip Temperature	T _{JT}	+150	+175	—	°C	—
Thermal Hysteresis	—	—	+1	—	°C	—
Unclamped Single Pulse Inductive Energy T _J = +25°C	E _{AS}	550	—	—	mJ	I _{D(ISO)} = 0.7A, V _{DD} = 32V
Unclamped Single Pulse Inductive Energy T _J = +150°C	E _{AS}	200	—	—	mJ	I _{D(ISO)} = 0.7A, V _{DD} = 32V
Status Flag						
Normal Operation	V _{STATUS}	—	4.95	—	V	V _{IN} = 5V
Current Limit Operating	V _{STATUS}	—	2.5	—	V	V _{IN} = 5V
Thermal Shutdown Activated	V _{STATUS}	—	0.2	1	V	V _{IN} = 5V
Normal Operation	V _{STATUS}	—	8	—	V	V _{IN} = 10V
Current Limit Operation	V _{STATUS}	—	3	—	V	V _{IN} = 10V
Thermal Shutdown Activated	V _{STATUS}	—	0.35	1	V	V _{IN} = 10V
Inverse Diode						
Source Drain Voltage	V _{SD}	—	—	1	V	V _{IN} = 0V, -I _D = 1.4A

Note: 9. Integrated protection functions are designed to prevent IC destruction under fault conditions described in the datasheet. Fault conditions are considered as "outside" normal operating range. Protection functions are not designed for continuous, repetitive operation.

Typical Characteristics

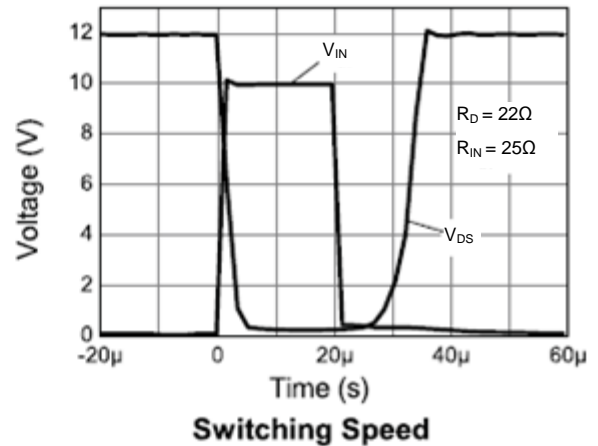
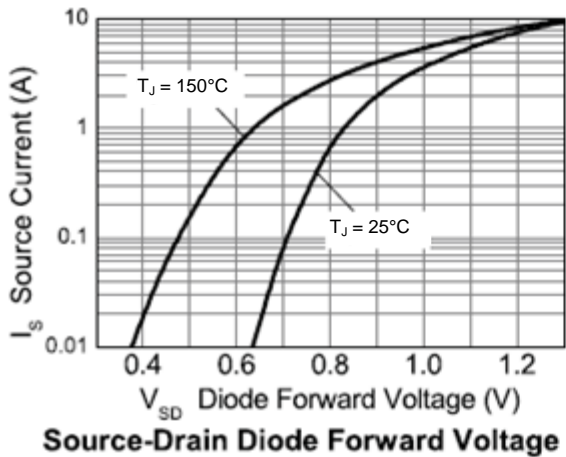
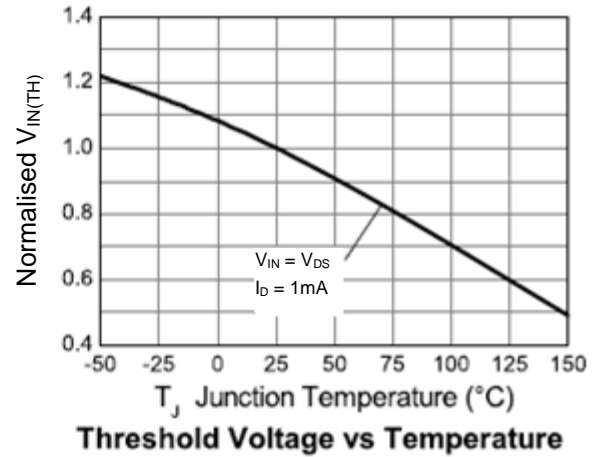
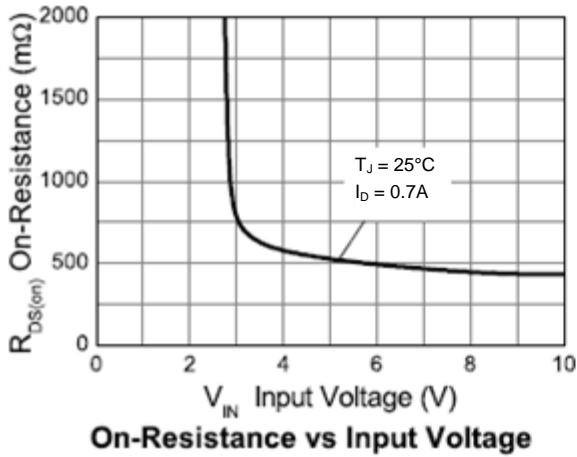
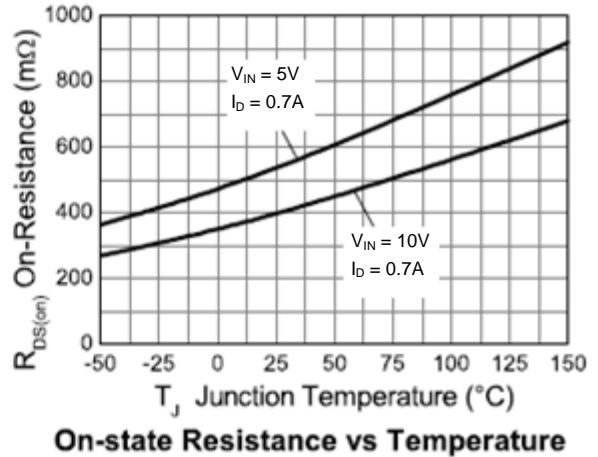
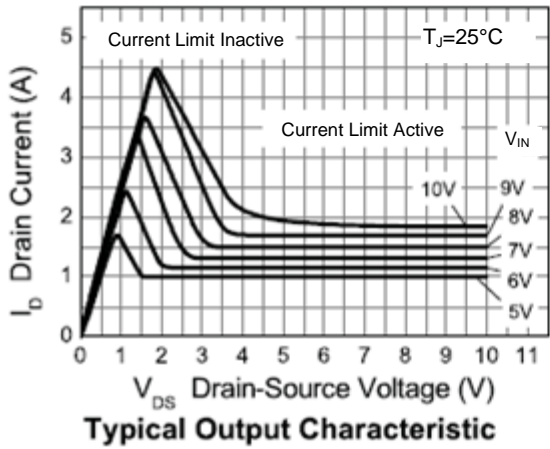

Typical Characteristics (continued)

Current Limiting and Over Temp Shutdown Status Indication at $V_{IN} = 5V$

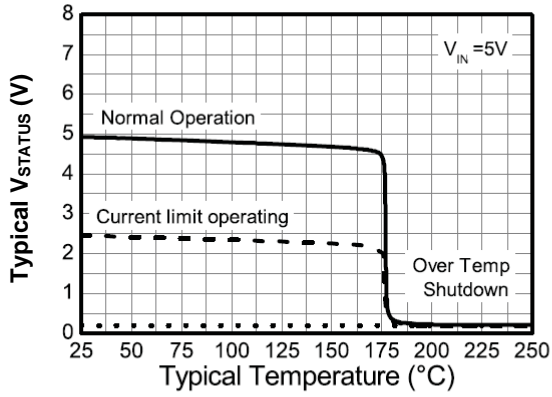

Current Limiting and Over Temp Shutdown Status Indication at $V_{IN} = 10V$

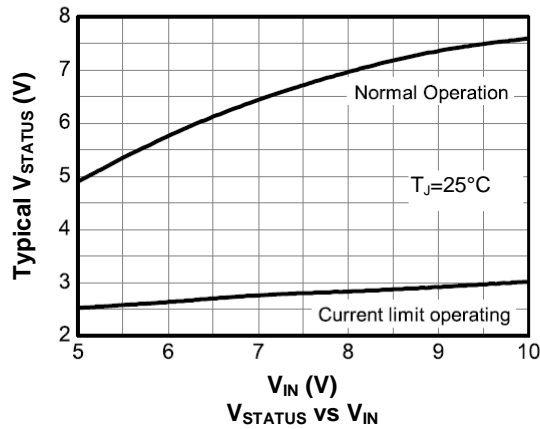
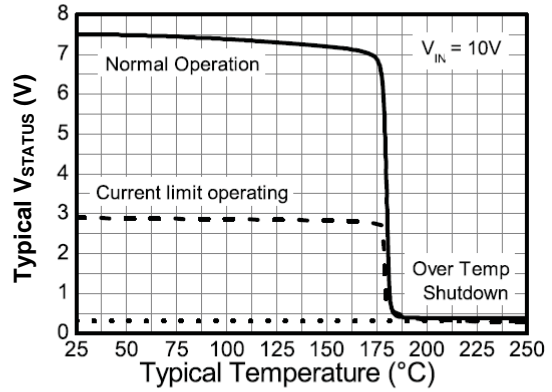

Package Outline Dimensions

Please see <http://www.diodes.com/package-outlines.html> for the latest version.

SOT223 (Type DN)

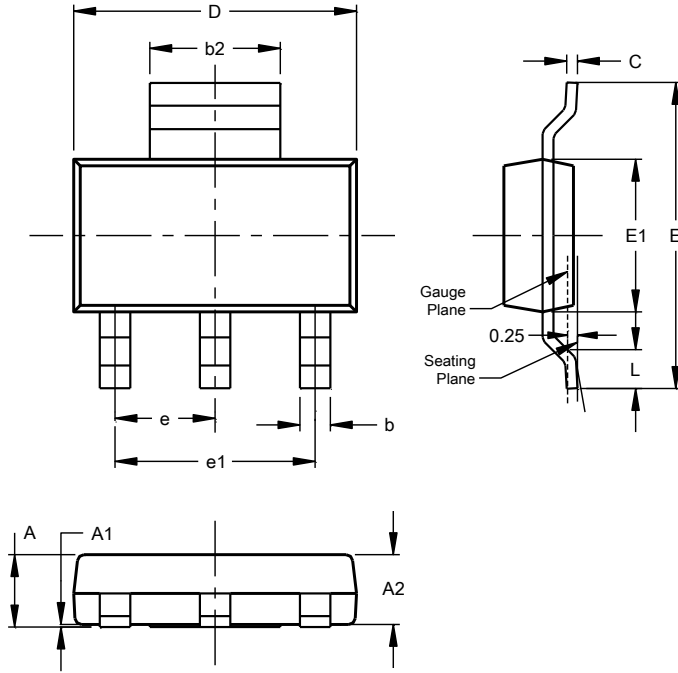

SOT223 (Type DN)			
Dim	Min	Max	Typ
A	--	1.70	--
A1	0.01	0.15	--
A2	1.50	1.68	1.60
b	0.60	0.80	0.70
b2	2.90	3.10	--
c	0.20	0.32	--
D	6.30	6.70	--
E	6.70	7.30	--
E1	3.30	3.70	--
e	--	--	2.30
e1	--	--	4.60
L	0.85	--	--
All Dimensions in mm			

Suggested Pad Layout

Please see <http://www.diodes.com/package-outlines.html> for the latest version.

SOT223 (Type DN)

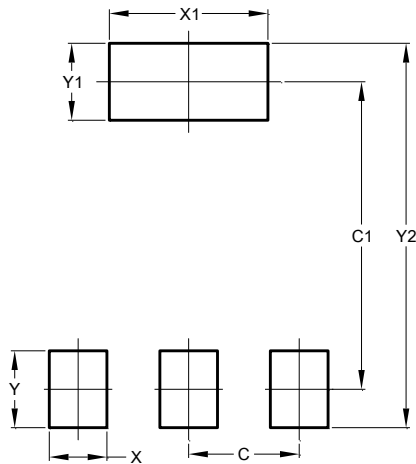

Dimensions	Value (in mm)
C	2.30
C1	6.40
X	1.20
X1	3.30
Y	1.60
Y1	1.60
Y2	8.00

IMPORTANT NOTICE

DIODES INCORPORATED MAKES NO WARRANTY OF ANY KIND, EXPRESS OR IMPLIED, WITH REGARDS TO THIS DOCUMENT, INCLUDING, BUT NOT LIMITED TO, THE IMPLIED WARRANTIES OF MERCHANTABILITY AND FITNESS FOR A PARTICULAR PURPOSE (AND THEIR EQUIVALENTS UNDER THE LAWS OF ANY JURISDICTION).

Diodes Incorporated and its subsidiaries reserve the right to make modifications, enhancements, improvements, corrections or other changes without further notice to this document and any product described herein. Diodes Incorporated does not assume any liability arising out of the application or use of this document or any product described herein; neither does Diodes Incorporated convey any license under its patent or trademark rights, nor the rights of others. Any Customer or user of this document or products described herein in such applications shall assume all risks of such use and will agree to hold Diodes Incorporated and all the companies whose products are represented on Diodes Incorporated website, harmless against all damages.

Diodes Incorporated does not warrant or accept any liability whatsoever in respect of any products purchased through unauthorized sales channel. Should Customers purchase or use Diodes Incorporated products for any unintended or unauthorized application, Customers shall indemnify and hold Diodes Incorporated and its representatives harmless against all claims, damages, expenses, and attorney fees arising out of, directly or indirectly, any claim of personal injury or death associated with such unintended or unauthorized application.

Products described herein may be covered by one or more United States, international or foreign patents pending. Product names and markings noted herein may also be covered by one or more United States, international or foreign trademarks.

This document is written in English but may be translated into multiple languages for reference. Only the English version of this document is the final and determinative format released by Diodes Incorporated.

LIFE SUPPORT

Diodes Incorporated products are specifically not authorized for use as critical components in life support devices or systems without the express written approval of the Chief Executive Officer of Diodes Incorporated. As used herein:

A. Life support devices or systems are devices or systems which:

1. are intended to implant into the body, or
2. support or sustain life and whose failure to perform when properly used in accordance with instructions for use provided in the labeling can be reasonably expected to result in significant injury to the user.

B. A critical component is any component in a life support device or system whose failure to perform can be reasonably expected to cause the failure of the life support device or to affect its safety or effectiveness.

Customers represent that they have all necessary expertise in the safety and regulatory ramifications of their life support devices or systems, and acknowledge and agree that they are solely responsible for all legal, regulatory and safety-related requirements concerning their products and any use of Diodes Incorporated products in such safety-critical, life support devices or systems, notwithstanding any devices- or systems-related information or support that may be provided by Diodes Incorporated. Further, Customers must fully indemnify Diodes Incorporated and its representatives against any damages arising out of the use of Diodes Incorporated products in such safety-critical, life support devices or systems.

Copyright © 2019, Diodes Incorporated

www.diodes.com

Looking for pricing, stock, or lifecycle information?

Click below to explore more details on WIN SOURCE:

- ⊖ [View ZXMS6002GTA on WIN SOURCE](#)
- ⊖ [Diodes Incorporated Information](#)

Optimize Your Supply Chain with WIN SOURCE Solutions

- ✓ Global Sourcing Solution
- ✓ Obsolete Management
- ✓ Cost Control Management
- ✓ Shortage Management
- ✓ Alternative Solution
- ✓ Excess Inventory Management