



**THE DATASHEET OF  
ZXCT1009T8TA**



### Description

The ZXCT1009 is a high side current sense monitor. Using this device eliminates the need to disrupt the ground plane when sensing a load current.

It takes a high side voltage developed across a current shunt resistor and translates it into a proportional output current. A user defined output resistor scales the output current into a ground-referenced voltage.

The wide input voltage range of 20V down to as low as 2.5V make it suitable for a range of applications. A minimum operating current of just 4 $\mu$ A, combined with a SOT23 package make it a unique solution for portable battery equipment. The SM8 device offers an alternative package option.

### Features

- Low cost, accurate high-side current sensing
- Output voltage scaling
- Up to 2.5V sense voltage
- 2.5V to 20V supply range
- 4 $\mu$ A quiescent current
- 1% typical accuracy
- SOT23 and SM8 packages
- AEC-Q100.3 qualified; ZXCT1009FTA only

### Applications

- Battery chargers
- Smart battery packs
- DC motor control
- Over current monitor
- Power management
- Level translating
- Programmable current source
- 

### Application Circuit

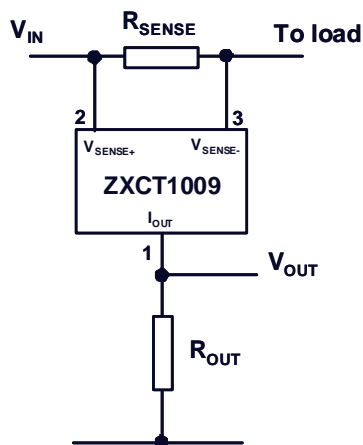

### Pin Assignments

#### SOT23

##### Package Suffix - F

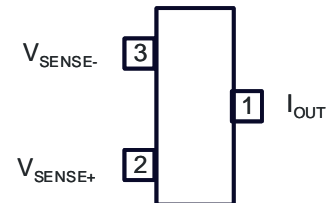

(Top View)

#### SM8

##### Package Suffix - T8

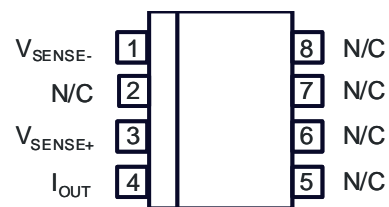

(Top View)

### Pin Descriptions

Pin Name	Pin Function
V <sub>SENSE+</sub>	Connection to supply voltage
V <sub>SENSE-</sub>	Connection to load
I <sub>OUT</sub>	Output current, proportional to measured current

### Absolute Maximum Ratings (T<sub>A</sub> = 25°C)

Description	Rating	Unit	
Voltage on any pin (relative to I <sub>OUT</sub> )	-0.6 to 20	V	
Continuous output current, I <sub>OUT</sub>	25	mA	
Continuous sense voltage, V <sub>SENSE</sub> <sup>†</sup>	-0.5 to +5	V	
Operating temperature, T <sub>A</sub>	-40 to 85	°C	
Storage temperature	-55 to 125	°C	
Package power dissipation @ T <sub>A</sub> = 25°C (Derate to zero @ 125°C)	SOT23	450	mW
	SM8	2	W

Operation above the absolute maximum rating may cause device failure. Operation at the absolute maximum ratings for extended periods may reduce device reliability.

### Electrical Characteristics (T<sub>A</sub> = 25°C, V<sub>IN</sub> = 5V, R<sub>OUT</sub> = 100Ω)

Symbol	Parameter	Conditions	Limits			Units
			Min	Typ	Max	
V <sub>IN</sub>	V <sub>CC</sub> range		2.5		20	V
I <sub>OUT</sub> <sup>1</sup>	Output Current	V <sub>SENSE</sub> = 0V	1	4	15	μA
		V <sub>SENSE</sub> = 10mV	90	104	120	μA
		V <sub>SENSE</sub> = 100mV	0.975	1.002	1.025	mA
		V <sub>SENSE</sub> = 200mV	1.95	2.0	2.05	mA
		V <sub>SENSE</sub> = 1V	9.6	9.98	10.2	mA
V <sub>SENSE</sub> <sup>†</sup>	Sense Voltage		0		2500	mV
I <sub>SENSE-</sub>	V <sub>SENSE-</sub> Input Current				100	nA
ACC	Accuracy	R <sub>SENSE</sub> = 0.1Ω V <sub>SENSE</sub> = 200mV	-2.5		2.5	%
G <sub>M</sub>	Transconductance, I <sub>OUT</sub> /V <sub>SENSE</sub>			10000		μA/V
BW	Bandwidth	V <sub>SENSE(DC)</sub> = 10mV, RF P <sub>IN</sub> = -40dBm <sup>‡</sup>		300		kHz
		V <sub>SENSE(DC)</sub> = 100mV, RF P <sub>IN</sub> = -20dBm <sup>‡</sup>		2		MHz

- Notes:
- Includes input offset voltage contribution
  - V<sub>SENSE</sub> is defined as the differential voltage between V<sub>SENSE+</sub> and V<sub>SENSE-</sub>.  

$$V_{SENSE} = V_{SENSE+} - V_{SENSE-}$$

$$= V_{IN} - V_{LOAD}$$

$$= I_{LOAD} \times R_{SENSE}$$
  - 20dBm=63mVpp into 50Ω

**Typical Characteristics**

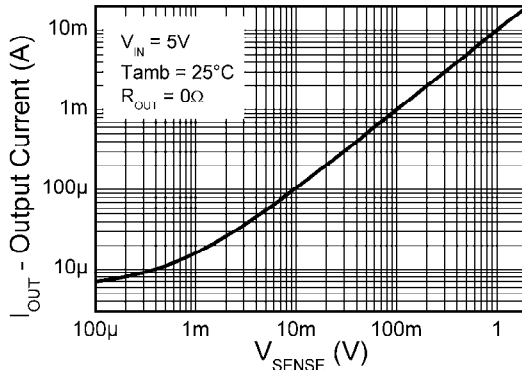

**Typical Output v Sense Voltage**

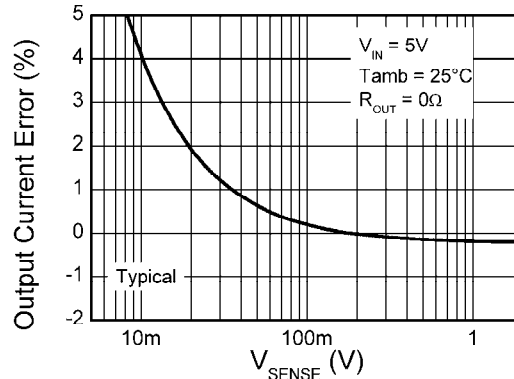

**Error v Sense Voltage**

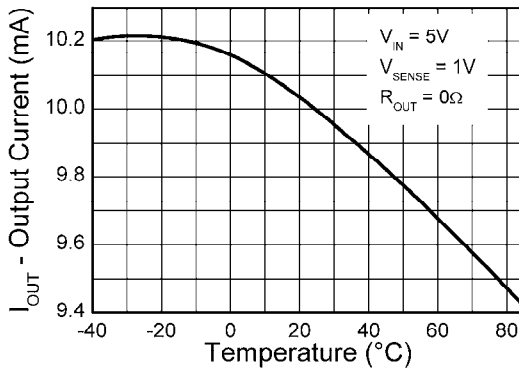

**Output Current v Temperature**

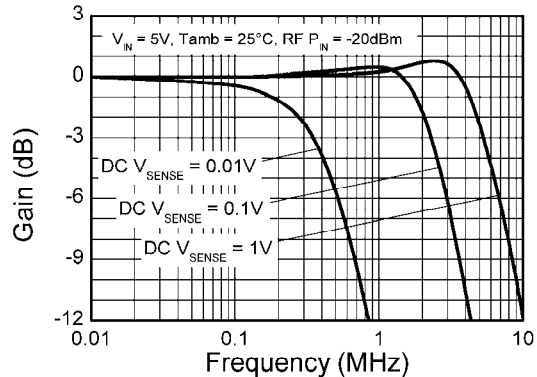

**Frequency Response**

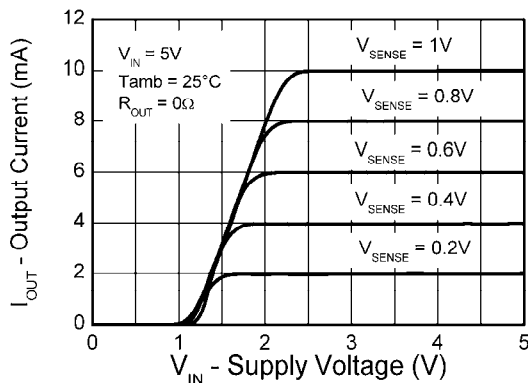

**Transfer Characteristic**

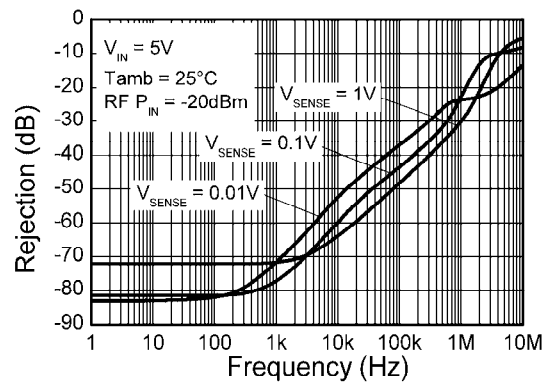

**Common Mode Rejection**

**Typical Characteristics (cont.)**

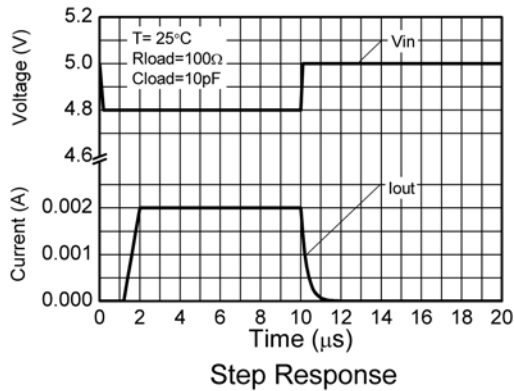

**Power Dissipation**

The maximum allowable power dissipation of the device for normal operation ( $P_{MAX}$ ), is a function of the package junction to ambient thermal resistance ( $\theta_{JA}$ ), maximum junction temperature ( $T_{JMAX}$ ), and ambient temperature ( $T_{AMB}$ ), according to the expression:

$$P_{MAX} = (T_{JMAX} - T_{AMB}) / \theta_{JA}$$

The device power dissipation,  $P_D$  is given by the expression:

$$P_D = I_{OUT}(V_{IN} - V_{OUT}) W$$

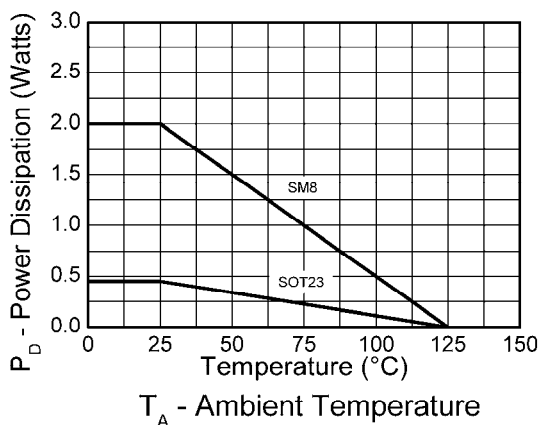

**Application Information**

The following text describes how to scale a load current to an output voltage.

$$V_{SENSE} = V_{IN} - V_{LOAD}$$

$$V_{OUT} = 0.01 \times V_{SENSE} \times R_{OUT}^1$$

E.g.

A 1A current is to be represented by a 100mV output voltage:

1) Choose the value of  $R_{SENSE}$  to give 50mV >

$V_{SENSE} > 500mV$  at full load.

For example  $V_{SENSE} = 100mV$  at 1.0A.

$$R_{SENSE} = 0.1/1.0 \Rightarrow 0.1\Omega.$$

2) Choose  $R_{OUT}$  to give  $V_{OUT} = 100mV$ , when

$V_{SENSE} = 100mV$ .

Rearranging <sup>1</sup> for Rout gives:

$$R_{OUT} = V_{OUT} / (V_{SENSE} \times 0.01)$$

$$R_{OUT} = 0.1 / (0.1 \times 0.01) = 100\Omega$$



**Application Information (cont.)**

**PCB trace shunt resistor for low cost solution**

The figure below shows output characteristics of the device when using a PCB resistive trace for a low cost solution in replacement for a conventional shunt resistor. The graph shows the linear rise in voltage across the resistor due to the PTC of the material and demonstrates how this rise in resistance value over temperature compensates for the NTC of the device.

The figure opposite shows a PCB layout suggestion. The resistor section is 25mm x 0.25mm giving approximately 150mΩ using 1oz copper. The data for the normalised graph was obtained using a 1A load current and a 100Ω output resistor. An electronic version of the PCB layout is available through Diodes applications group.

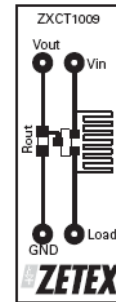

Layout shows area of shunt resistor compared to SOT23 package. Not actual size.

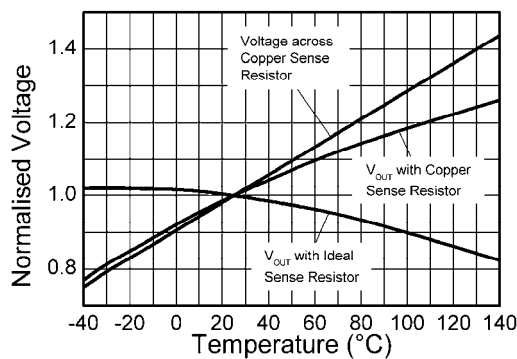

Effect of Sense Resistor Material on Temperature Performance

**Effect of Sense Resistor Material on Temperature Performance**

**Ordering Information**

Device	AEC-Q100 level	Reel Size	Tape Width	Quantity per Reel	Part Marking	Package
ZXCT1009FTA	Grade 3	7"	8mm	3000 Units	109	SOT23
ZXCT1009F-7	None	7"	8mm	3000 Units	109	SOT23
ZXCT1009T8TA	None	7"	12mm	1000 Units	ZXCT1009	SM8

**Package Outline Dimensions (All Dimensions in mm)**

**1) SOT23**

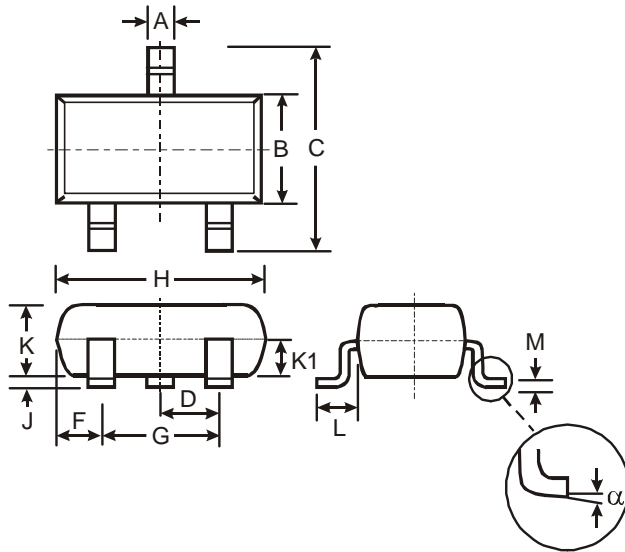

SOT23			
Dim	Min	Max	Typ
A	0.37	0.51	0.40
B	1.20	1.40	1.30
C	2.30	2.50	2.40
D	0.89	1.03	0.915
F	0.45	0.60	0.535
G	1.78	2.05	1.83
H	2.80	3.00	2.90
J	0.013	0.10	0.05
K	0.903	1.10	1.00
K1	-	-	0.400
L	0.45	0.61	0.55
M	0.085	0.18	0.11
α	0°	8°	-
All Dimensions in mm			

**2) SM8**

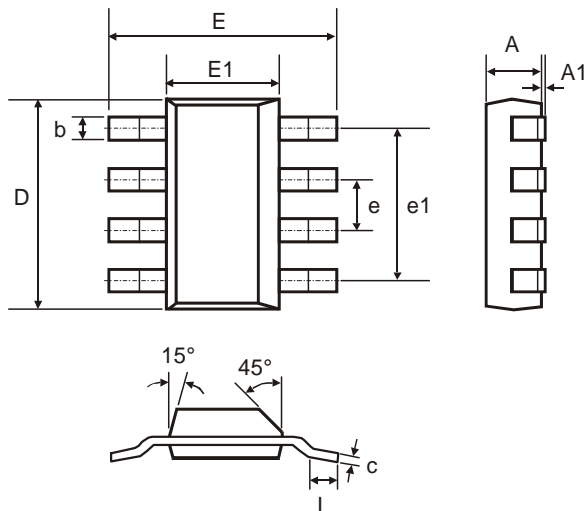

SM-8			
Dim	Min	Max	Typ
A	-	1.7	-
A1	0.02	0.1	-
b	-	0.7	-
c	0.24	0.32	-
D	6.3	6.7	-
e	-	-	1.53
e1	-	-	4.59
E	6.7	7.3	-
E1	3.3	3.7	-
L	0.9	-	-
All Dimensions in mm			

**IMPORTANT NOTICE**

DIODES INCORPORATED MAKES NO WARRANTY OF ANY KIND, EXPRESS OR IMPLIED, WITH REGARDS TO THIS DOCUMENT, INCLUDING, BUT NOT LIMITED TO, THE IMPLIED WARRANTIES OF MERCHANTABILITY AND FITNESS FOR A PARTICULAR PURPOSE (AND THEIR EQUIVALENTS UNDER THE LAWS OF ANY JURISDICTION).

Diodes Incorporated and its subsidiaries reserve the right to make modifications, enhancements, improvements, corrections or other changes without further notice to this document and any product described herein. Diodes Incorporated does not assume any liability arising out of the application or use of this document or any product described herein; neither does Diodes Incorporated convey any license under its patent or trademark rights, nor the rights of others. Any Customer or user of this document or products described herein in such applications shall assume all risks of such use and will agree to hold Diodes Incorporated and all the companies whose products are represented on Diodes Incorporated website, harmless against all damages.

Diodes Incorporated does not warrant or accept any liability whatsoever in respect of any products purchased through unauthorized sales channel.

Should Customers purchase or use Diodes Incorporated products for any unintended or unauthorized application, Customers shall indemnify and hold Diodes Incorporated and its representatives harmless against all claims, damages, expenses, and attorney fees arising out of, directly or indirectly, any claim of personal injury or death associated with such unintended or unauthorized application.

Products described herein may be covered by one or more United States, international or foreign patents pending. Product names and markings noted herein may also be covered by one or more United States, international or foreign trademarks.

**LIFE SUPPORT**

Diodes Incorporated products are specifically not authorized for use as critical components in life support devices or systems without the express written approval of the Chief Executive Officer of Diodes Incorporated. As used herein:

A. Life support devices or systems are devices or systems which:

1. are intended to implant into the body, or
2. support or sustain life and whose failure to perform when properly used in accordance with instructions for use provided in the labeling can be reasonably expected to result in significant injury to the user.

B. A critical component is any component in a life support device or system whose failure to perform can be reasonably expected to cause the failure of the life support device or to affect its safety or effectiveness.

Customers represent that they have all necessary expertise in the safety and regulatory ramifications of their life support devices or systems, and acknowledge and agree that they are solely responsible for all legal, regulatory and safety-related requirements concerning their products and any use of Diodes Incorporated products in such safety-critical, life support devices or systems, notwithstanding any devices- or systems-related information or support that may be provided by Diodes Incorporated. Further, Customers must fully indemnify Diodes Incorporated and its representatives against any damages arising out of the use of Diodes Incorporated products in such safety-critical, life support devices or systems.

Copyright © 2011, Diodes Incorporated

[www.diodes.com](http://www.diodes.com)

## Looking for pricing, stock, or lifecycle information?

Click below to explore more details on WIN SOURCE:

 [View ZXCT1009T8TA on WIN SOURCE](#)

 [Diodes Incorporated](#) Information

## Optimize Your Supply Chain with WIN SOURCE Solutions

-  Global Sourcing Solution
-  Obsolete Management
-  Cost Control Management
-  Shortage Management
-  Alternative Solution
-  Excess Inventory Management