



**THE DATASHEET OF  
ZR40402F25TA**



# PRECISION 2.5 VOLT MICROPOWER VOLTAGE REFERENCE

## ZR4040-2.5

ISSUE 4 - JANUARY 2003

### DEVICE DESCRIPTION

The ZR4040-2.5 uses a bandgap circuit design to achieve a precision micropower voltage reference of 2.5 volts. The device is available in a small outline surface mount package, ideal for applications where space saving is important, as well as packages for through hole requirements.

The ZR4040-2.5 design provides a stable voltage without an external capacitor and is stable with capacitive loads. The ZR4040-2.5 is recommended for operation between 60 $\mu$ A and 15mA and so is ideally suited to low power and battery powered applications.

Excellent performance is maintained to an absolute maximum of 25mA, however the rugged design and 20 volt processing allows the reference to withstand transient effects and currents up to 200mA. Superior switching capability allows the device to reach stable operating conditions in only a few microseconds.

### FEATURES

- Small outline SOT23 package
- TO92 style package
- No stabilising capacitor required
- Typical  $T_c$  30ppm/ $^{\circ}$ C
- Typical slope resistance 0.4 $\Omega$
- 2% 1% and 0.5 % tolerance
- Industrial temperature range
- Operating current 60 $\mu$ A to 15mA
- Transient response, stable in less than 10 $\mu$ s

### APPLICATIONS

- Battery powered and portable equipment.
- Metering and measurement systems.
- Instrumentation.
- Test equipment.
- Data acquisition systems.
- Precision power supplies.

### SCHEMATIC DIAGRAM

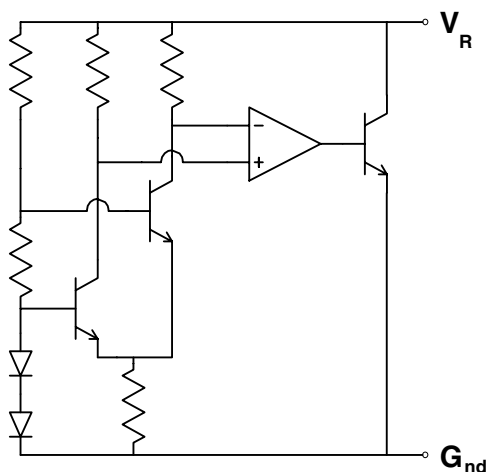

# ZR4040-2.5

## ABSOLUTE MAXIMUM RATING

Reverse Current	25mA
Forward Current	25mA
Operating Temperature	-40 to 85°C
Storage Temperature	-55 to 125°C

## Power Dissipation (T<sub>amb</sub>=25°C)

SOT23	330mW
E-Line, 3 pin (TO92)	500mW

## ELECTRICAL CHARACTERISTICS

### TEST CONDITIONS (Unless otherwise stated) T<sub>amb</sub>=25°C

SYMBOL	PARAMETER	CONDITIONS	LIMITS			TOL. %	UNITS
			MIN	TYP	MAX		
V <sub>R</sub>	Reverse Breakdown Voltage	I <sub>R</sub> =150μA	2.4875 2.475 2.45	2.5 2.5 2.5	2.5125 2.525 2.55	0.5 1 2	V
I <sub>MIN</sub>	Minimum Operating Current			25	60		μA
I <sub>R</sub>	Recommended Operating Current		0.06		15		mA
T <sub>C</sub> †	Average Reverse Breakdown Voltage Temp. Co.	I <sub>R(min)</sub> to I <sub>R(max)</sub>		30	100		ppm/°C
R <sub>S</sub> §	Slope Resistance			0.4	2		Ω
Z <sub>R</sub>	Reverse Dynamic Impedance	I <sub>R</sub> = 1mA f = 100Hz I <sub>AC</sub> =0.1 I <sub>R</sub>		0.3	0.8		Ω
E <sub>N</sub>	Wideband Noise Voltage	I <sub>R</sub> = 1mA f = 10Hz to 10kHz		45			μV (rms)

$$\dagger T_C = \frac{(V_{R(max)} - V_{R(min)}) \times 1000000}{V_R \times (T_{(max)} - T_{(min)})}$$

Note: V<sub>R(max)</sub> - V<sub>R(min)</sub> is the maximum deviation in reference voltage measured over the full operating temperature range.

$$\S R_S = \frac{V_R \text{ Change } (I_R \text{ (min) to } I_R \text{ (max)})}{I_R \text{ (max)} - I_R \text{ (min)}}$$

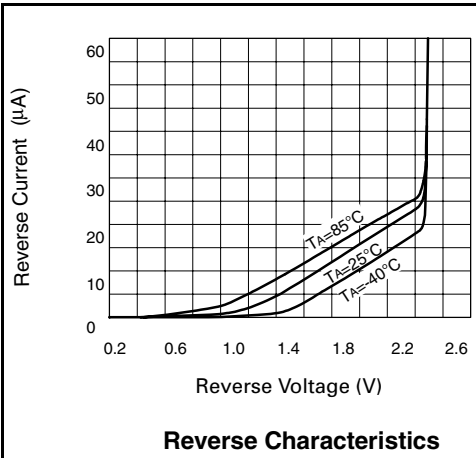

Reverse Characteristics

# ZR4040-2.5

## TYPICAL CHARACTERISTICS

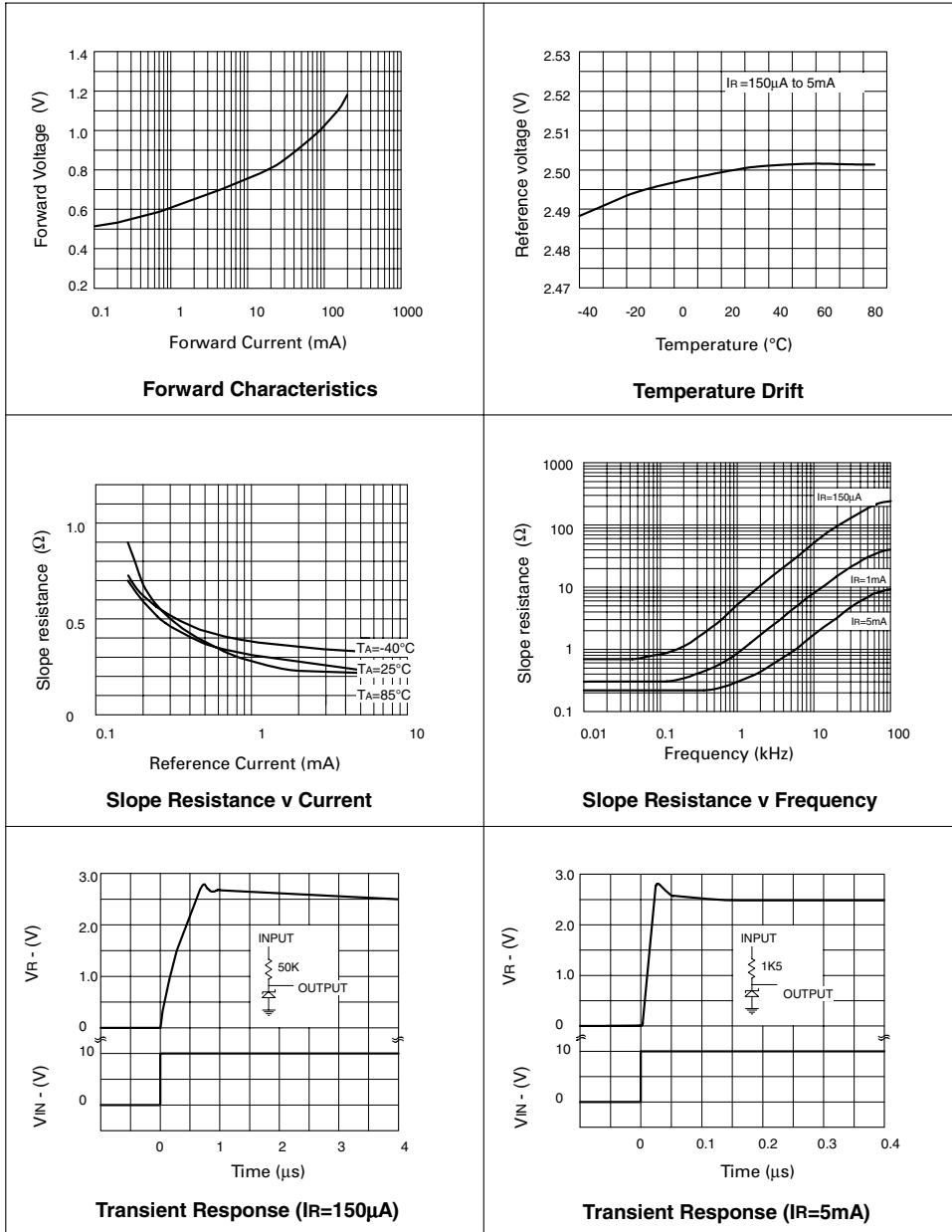

# ZR4040-2.5

## CONNECTION DIAGRAMS

### E-Line, 3 pin, Rev Package Suffix - R

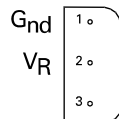

Bottom View -  
Pin 3 floating or connected to pin 1

### SOT23 Package Suffix - F

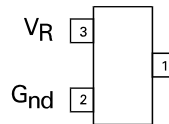

Top View -  
Pin 1 floating or connected to pin 2



## ORDERING INFORMATION

Part Number	Tol%	Package	Partmark
ZR40402F25	2	SOT23	25L
ZR40401F25	1	SOT23	25M
ZR404005F25	0.5	SOT23	25V
ZR40402R25	2	E-Line *	ZR4040225
ZR40401R25	1	E-Line *	ZR4040125
ZR404005R25	0.5	E-Line *	ZR4040525

\* E-Line, 3 pin Reversed

## Looking for pricing, stock, or lifecycle information?

Click below to explore more details on WIN SOURCE:

-  [View ZR40402F25TA on WIN SOURCE](#)
-  [Diodes Incorporated Information](#)

## Optimize Your Supply Chain with WIN SOURCE Solutions

-  Global Sourcing Solution
-  Obsolete Management
-  Cost Control Management
-  Shortage Management
-  Alternative Solution
-  Excess Inventory Management