



**THE DATASHEET OF  
ZL30321GGG2**



## Features

- Provides synchronous clocks for network interface cards that support synchronous Ethernet (SyncE) in addition to telecom interfaces (e.g. T1/E1, DS3/E3, etc)
- Two independent DPLLs provides timing for the transmit path (backplane to line rate) and the receive path (recovered line rate to backplane)
- Supports the requirements of ITU-T G.8262 for Synchronous Ethernet equipment slave clocks (EEC option 1 and 2) when combined with a system synchronizer such as the ZL30116, ZL30121, ZL30130, ZL30138
- Supports the requirements of Telcordia GR-253 SONET clocks and ITU-T G.813 SDH equipment slave clocks (SEC)
- Synchronizes to any standard telecom system reference with a multiple of 8 kHz up to 77.76 MHz or to Ethernet clock rates including 25 MHz, 50 MHz, 62.5 MHz, and 125 MHz
- Low jitter APLL generates either Ethernet clock rates (25 MHz, 50 MHz, 62.5 MHz, and 125 MHz) or SONET/SDH (6.48 MHz, 19.44 MHz, 38.88 MHz, 51.84 MHz, 77.76 MHz) clock rates
- Programmable output synthesizers (P0, P1) generate clock frequencies with any multiple of 8 kHz up to 100 MHz

## Ordering Information

ZL30321GGG 100 Pin CABGA Trays

ZL30321GGG2 100 Pin CABGA\* Trays

\*Pb Free Tin/Silver/Copper in sampling phase

**-40°C to +85°C**

- Supports automatic hitless reference switching and short term holdover during loss of reference inputs
- DPLLs can be configured to provide synchronous or asynchronous clock outputs
- Generates several styles of output frame pulses with selectable pulse width, polarity, and frequency
- Flexible input reference monitoring automatically disqualifies references based on frequency and phase irregularities

## Applications

- Carrier Grade Ethernet/SONET/SDH/PDH Network Interface Cards
- GPON ONT/ONU
- T1/E1 line cards
- DS3/E3 line cards

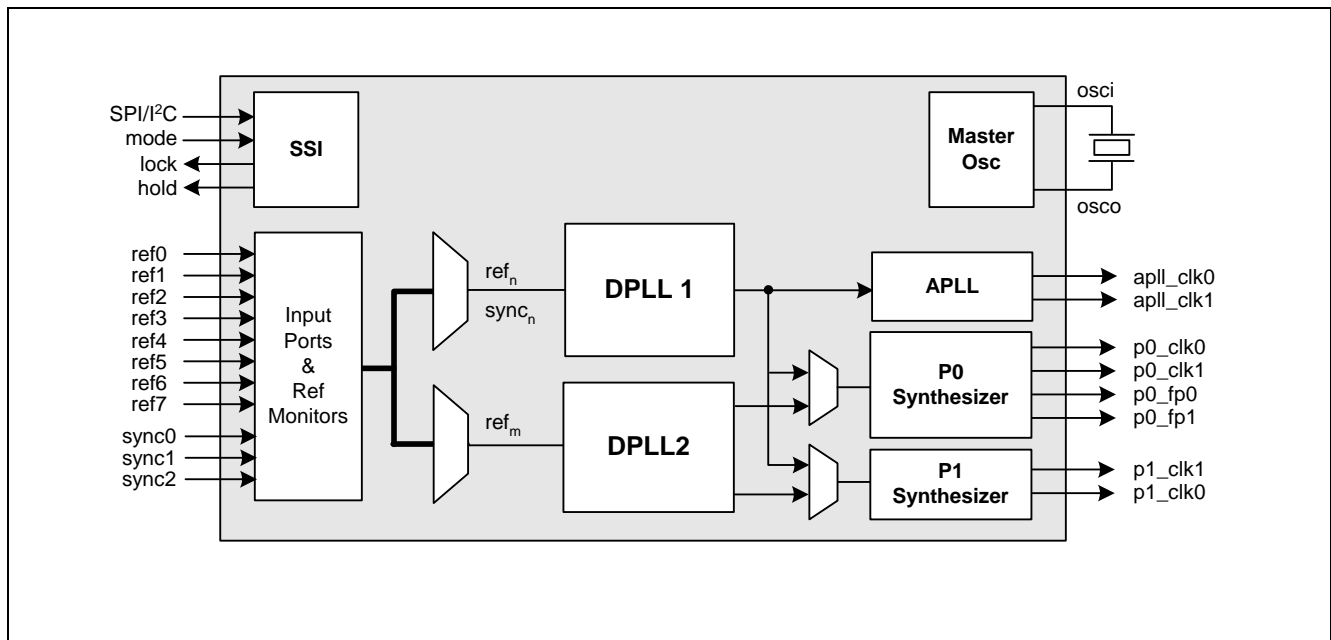

## Pin Description

| 100BGA Pin #                                 | Name   | I/O Type       | Description   |
|--|--|----------------|---|
| <b>Input Reference</b>                       |  |                |   |
| C1<br>B2<br>A3<br>C3<br>B3<br>B4<br>C4<br>A4 | ref0<br>ref1<br>ref2<br>ref3<br>ref4<br>ref5<br>ref6<br>ref7 | I <sub>U</sub> | <b>Input References 7:0 (LVCMOS, Schmitt Trigger).</b> These input references are available to both DPLL1 and DPLL2 for synchronizing output clocks. All eight input references can lock to any multiple of 8 kHz up to 77.76 MHz including 25 MHz and 50 MHz. Input ref0 and ref1 have additional configurable pre-dividers allowing input frequencies such as 62.5 MHz, 125 MHz. These pins are internally pulled up to V <sub>dd</sub> . |
| B1<br>A1<br>A2                               | sync0<br>sync1<br>sync2                                      | I <sub>U</sub> | <b>Frame Pulse Synchronization References 2:0 (LVCMOS, Schmitt Trigger).</b> These are optional frame pulse synchronization inputs associated with input references 0, 1 and 2. These inputs accept frame pulses in a clock format (50% duty cycle) or a basic frame pulse format with minimum pulse width of 5 ns. These pins are internally pulled up to V <sub>dd</sub> .  |
| <b>Output Clocks and Frame Pulses</b>        |  |                |   |
| D10  | apll_clk0  | O              | <b>APLL Output Clock 0 (LVCMOS).</b> Output clock 0 of the APLL. The APLL can be configured to provide either SONET/SDH or Ethernet clock rates. The default frequency for this output is 77.76 MHz.  |
| G10  | apll_clk1  | O              | <b>APLL Output Clock 1 (LVCMOS).</b> Output clock 1 of the APLL. The APLL can be configured to provide either SONET/SDH or Ethernet clock rates. The default frequency for this output is 19.44 MHz.  |
| K9   | p0_clk0  | O              | <b>Programmable Synthesizer 0 - Output Clock 0 (LVCMOS).</b> This output can be configured to provide any frequency with a multiple of 8 kHz up to 100 MHz, in addition to 2 kHz. The default frequency for this output is 65.536 MHz.  |
| K7   | p0_clk1  | O              | <b>Programmable Synthesizer 0 - Output Clock 1 (LVCMOS).</b> This is a programmable clock output configurable as a multiple or division of the p0_clk0 frequency within the range of 2 kHz to 100 MHz. The default frequency for this output is 32.768 MHz.   |
| K8   | p0_fp0   | O              | <b>Programmable Synthesizer 0 - Output Frame Pulse 0 (LVCMOS).</b> This output can be configured to provide virtually any style of output frame pulse associated with the p0 clocks. The default frequency for this frame pulse output is 8 kHz.  |
| J7   | p0_fp1   | O              | <b>Programmable Synthesizer 0 - Output Frame Pulse 1 (LVCMOS).</b> This output can be configured to provide virtually any style of output frame pulse associated with the p0 clocks. The default frequency for this frame pulse output is 8 kHz.  |
| J10  | p1_clk0  | O              | <b>Programmable Synthesizer 1 - Output Clock 0 (LVCMOS).</b> This output can be configured to provide any frequency with a multiple of 8 kHz up to 100 MHz in addition to 2 kHz. The default frequency for this output is 34.368 MHz.   |
| K10  | p1_clk1  | O              | <b>Programmable Synthesizer1 - Output Clock 1 (LVCMOS).</b> This is a programmable clock output configurable as a multiple or division of the p1_clk0 frequency within the range of 2 kHz to 100 MHz. The default frequency for this output is 68.736 MHz.  |

| 100BGA Pin #            | Name         | I/O Type       | Description   |
|-------------------------|--------------|----------------|---|
| E1                      | ref_out      | O              | <b>DPLL2 Selected Output Reference (LVCMOS).</b> This is a buffered copy of the output of the reference selector for DPLL2. Switching between input reference clocks at this output is not hitless.   |
| <b>Control</b>          |              |                |   |
| H5                      | rst_b        | I              | <b>Reset (LVCMOS, Schmitt Trigger).</b> A logic low at this input resets the device. To ensure proper operation, the device must be reset after power-up. Reset should be asserted for a minimum of 300 ns.   |
| J5                      | hs_en        | I <sub>u</sub> | <b>DPLL1 Hitless Switching Enable (LVCMOS, Schmitt Trigger).</b> A logic high at this input enables hitless reference switching. A logic low disables hitless reference switching and re-aligns DPLL1's output phase to the phase of the selected reference input. This feature can also be controlled through software registers. This pin is internally pulled up to V <sub>dd</sub> .                        |
| C2<br>D2                | mod0<br>mod1 | I <sub>u</sub> | <b>DPLL1 Mode Select 1:0 (LVCMOS, Schmitt Trigger).</b> During reset, the levels on these pins determine the default mode of operation for DPLL1 (Automatic, Normal, Holdover or Freerun). After reset, the mode of operation can be controlled directly with these pins, or by accessing the dpll1_modesel register (0x1F) through the serial interface. This pin is internally pulled up to V <sub>dd</sub> . |
| <b>Status</b>           |              |                |   |
| H1                      | lock         | O              | <b>Lock Indicator (LVCMOS).</b> This is the lock indicator pin for DPLL1. This output goes high when DPLL1's output is frequency and phase locked to the input reference.   |
| J1                      | hold         | O              | <b>Holdover Indicator (LVCMOS).</b> This pin goes high when DPLL1 enters the holdover mode.   |
| <b>Serial Interface</b> |              |                |   |
| E2                      | sck_scl      | I/B            | <b>Clock for Serial Interface (LVCMOS).</b> Serial interface clock. When i2c_en = 0, this pin acts as the sck pin for the serial interface. When i2c_en = 1, this pin acts as the scl pin (bidirectional) for the I <sup>2</sup> C interface.   |
| F1                      | si_sda       | I/B            | <b>Serial Interface Input (LVCMOS).</b> Serial interface data pin. When i2c_en = 0, this pin acts as the si pin for the serial interface. When i2c_en = 1, this pin acts as the sda pin (bidirectional) for the I <sup>2</sup> C interface.   |
| G1                      | so           | O              | <b>Serial Interface Output (LVCMOS).</b> Serial interface data output. When i2c_en = 0, this pin acts as the so pin for the serial interface. When i2c_en = 1, this pin is unused and should be left unconnected.   |
| E3                      | cs_b_ase10   | I <sub>u</sub> | <b>Chip Select for SPI/Address Select 0 for I<sup>2</sup>C (LVCMOS).</b> When i2c_en = 0, this pin acts as the chip select pin (active low) for the serial interface. When i2c_en = 1, this pin acts as the ase10 pin for the I <sup>2</sup> C interface.   |
| F3                      | ase11        | I <sub>u</sub> | <b>Address Select 1 for I<sup>2</sup>C (LVCMOS).</b> When i2c_en = 1, this pin acts as the ase11 pin for the I <sup>2</sup> C interface. Internally pulled up to V <sub>dd</sub> . Leave open when not in use.  |
| F2                      | ase12        | I <sub>u</sub> | <b>Address Select 2 for I<sup>2</sup>C (LVCMOS).</b> When i2c_en = 1, this pin acts as the ase12 pin for the I <sup>2</sup> C interface. Internally pulled up to V <sub>dd</sub> . Leave open when not in use.  |

| 100BGA Pin #                        | Name        | I/O Type       | Description   |
|-------------------------------------|-------------|----------------|---|
| G2                                  | int_b       | O              | <b>Interrupt Pin (LVCMOS).</b> Indicates a change of device status prompting the processor to read the enabled interrupt service registers (ISR). This pin is an open drain, active low and requires an external pulled-up to Vdd.  |
| J2                                  | i2c_en      | I <sub>u</sub> | <b>I<sup>2</sup>C Interface Enable (LVCMOS).</b> If set high, the I <sup>2</sup> C interface is enabled, if set low, the SPI interface is enabled. Internally pull-up to Vdd.   |
| <b>APLL Loop Filter</b>             |             |                |   |
| A6                                  | apll_filter | A              | <b>External Analog PLL Loop Filter terminal.</b>  |
| B6                                  | filter_ref0 | A              | <b>Analog PLL External Loop Filter Reference.</b>   |
| C6                                  | filter_ref1 | A              | <b>Analog PLL External Loop Filter Reference.</b>   |
| <b>JTAG and Test</b>                |             |                |   |
| J4                                  | tdo         | O              | <b>Test Serial Data Out (Output).</b> JTAG serial data is output on this pin on the falling edge of tck. This pin is held in high impedance state when JTAG scan is not enabled.  |
| K2                                  | tdi         | I <sub>u</sub> | <b>Test Serial Data In (Input).</b> JTAG serial test instructions and data are shifted in on this pin. This pin is internally pulled up to Vdd. If this pin is not used then it should be left unconnected.   |
| H4                                  | trst_b      | I <sub>u</sub> | <b>Test Reset (LVCMOS).</b> Asynchronously initializes the JTAG TAP controller by putting it in the Test-Logic-Reset state. This pin should be pulsed low on power-up to ensure that the device is in the normal functional state. This pin is internally pulled up to Vdd. If this pin is not used then it should be connected to GND. |
| K3                                  | tck         | I              | <b>Test Clock (LVCMOS):</b> Provides the clock to the JTAG test logic. If this pin is not used then it should be pulled down to GND.  |
| J3                                  | tms         | I <sub>u</sub> | <b>Test Mode Select (LVCMOS).</b> JTAG signal that controls the state transitions of the TAP controller. This pin is internally pulled up to V <sub>DD</sub> . If this pin is not used then it should be left unconnected.  |
| <b>Master Clock</b>                 |             |                |   |
| K4                                  | osci        | I              | <b>Oscillator Master Clock Input (LVCMOS).</b> This input accepts a 20 MHz reference from a clock oscillator (TCXO, OCXO). The stability and accuracy of the clock at this input determines the free-run accuracy and the long term holdover stability of the output clocks.  |
| K5                                  | osco        | O              | <b>Oscillator Master Clock Output (LVCMOS).</b> This pin must be left unconnected when the osci pin is connected to a clock oscillator.   |
| <b>Miscellaneous</b>                |             |                |   |
| J6                                  | IC          |                | <b>Internal Connection.</b> Connect to ground.  |
| C5<br>B5<br>K6<br>H10<br>E10<br>F10 | IC          |                | <b>Internal Connection.</b> Leave unconnected.  |

| 100BGA<br>Pin #  | Name               | I/O<br>Type   | Description   |
|--|--------------------|---|---|
| D3<br>K1<br>H7<br>G3<br>D1<br>A9<br>B10<br>A10<br>B9   | NC                 |   | <b>No Connection.</b> Leave unconnected.                            |
| <b>Power and Ground</b>  |                    |   |   |
| D9<br>E4<br>G8<br>G9<br>J8<br>J9<br>H6<br>H8   | V <sub>DD</sub>    | P<br>P<br>P<br>P<br>P<br>P<br>P<br>P  | <b>Positive Supply Voltage.</b> +3.3V <sub>DC</sub> nominal.        |
| E8<br>F4   | V <sub>CORE</sub>  | P<br>P  | <b>Positive Supply Voltage.</b> +1.8V <sub>DC</sub> nominal.        |
| A5<br>A8<br>C10  | AV <sub>DD</sub>   | P<br>P<br>P   | <b>Positive Analog Supply Voltage.</b> +3.3V <sub>DC</sub> nominal. |
| B7<br>B8<br>H2   | AV <sub>CORE</sub> | P<br>P<br>P   | <b>Positive Analog Supply Voltage.</b> +1.8V <sub>DC</sub> nominal. |
| D4<br>D5<br>D6<br>D7<br>E5<br>E6<br>E7<br>F5<br>F6<br>F7<br>G4<br>G5<br>G6<br>G7<br>E9<br>F8<br>F9<br>H9 | V <sub>SS</sub>    | G<br>G<br>G<br>G<br>G<br>G<br>G<br>G<br>G<br>G<br>G<br>G<br>G<br>G<br>G<br>G<br>G<br>G<br>G | <b>Ground.</b> 0 Volts.   |

| 100BGA<br>Pin #                  | Name             | I/O<br>Type                | Description             |
|----------------------------------|------------------|----------------------------|-------------------------|
| A7<br>C7<br>C8<br>C9<br>D8<br>H3 | AV <sub>SS</sub> | G<br>G<br>G<br>G<br>G<br>G | Analog Ground. 0 Volts. |

I - Input

I<sub>d</sub> - Input, Internally pulled down

I<sub>u</sub> - Input, Internally pulled up

O - Output

A - Analog

P - Power

G - Ground

1.0 Pin Diagram

TOP VIEW

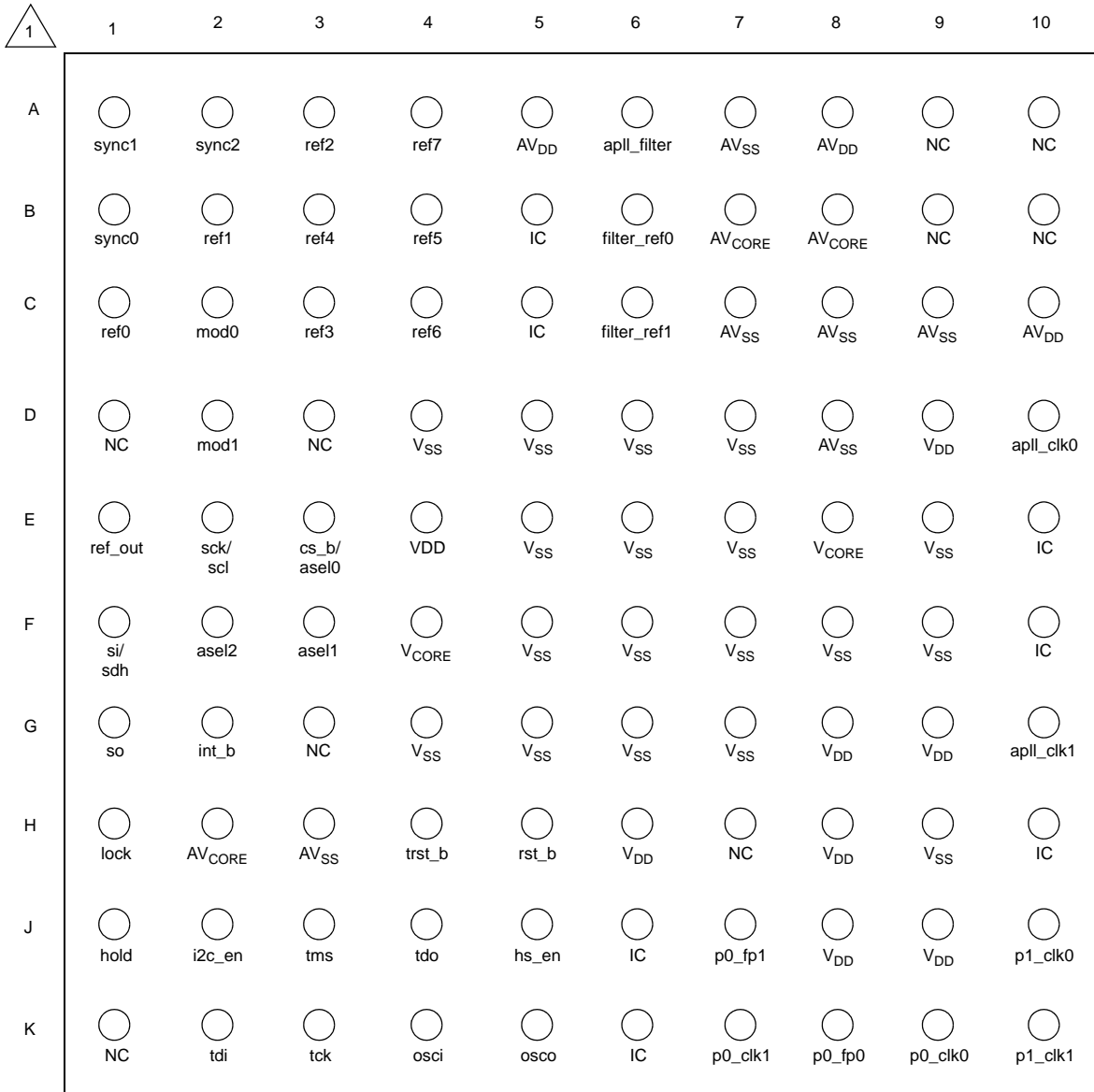

 1 - A1 corner is identified with a dot.

## 2.0 Overview

The ZL30321 SONET/SDH/GbE Mult-Rate Line Card Synchronizer is a highly integrated device that provides timing for network interface cards. It incorporates two independent DPLLs, each capable of locking to one of eight input references and provides a wide variety of synchronized output clocks and frame pulses.

This device is ideally suited for designs that require both a transmit timing path (backplane to PHY) and a receive timing path (PHY to backplane). Each path is controlled with separate DPLLs (DPLL1, DPLL1) which are both independently configurable through the serial interface (SPI or I<sup>2</sup>C). A typical application of the ZL30321 is shown in Figure 2. In this application, the ZL30321 translates the 19.44 MHz clock from the telecom rate backplane (system timing bus), translates the frequency to 125 MHz for the PHY Tx clock, and filters the jitter to ensure compliance with the related standards. A programmable synthesizer (P0) provides optional synchronous PDH clocks with multiples of 8 kHz for generating PDH interface clocks. On the receive path, DPLL2 and the P1 synthesizer translate the line recovered clock (8 kHz or 1.544 MHz) from the PHY to the 19.44 MHz telecom backplane (line recovered timing) for the central timing cards. The ZL30321 allows easy integration of Ethernet line rates with today's telecom backplanes.

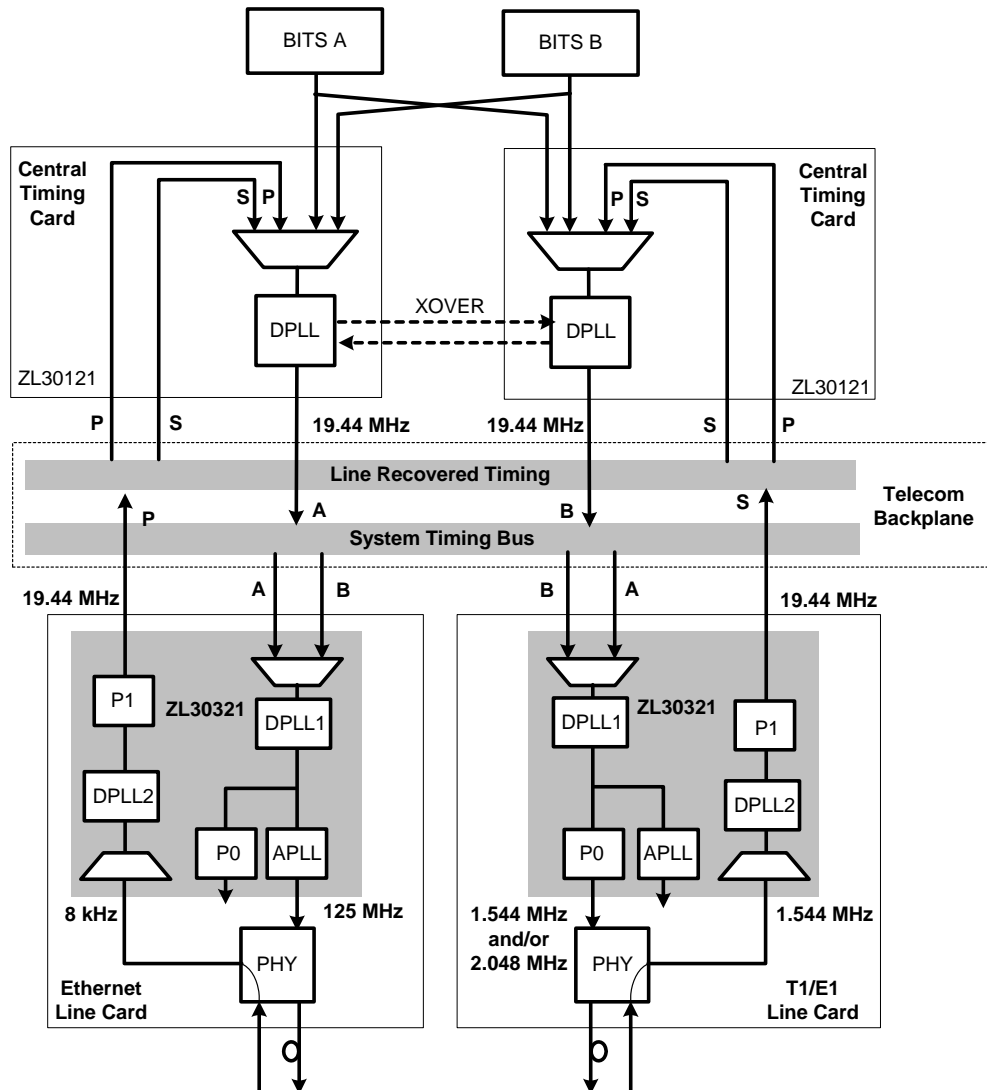
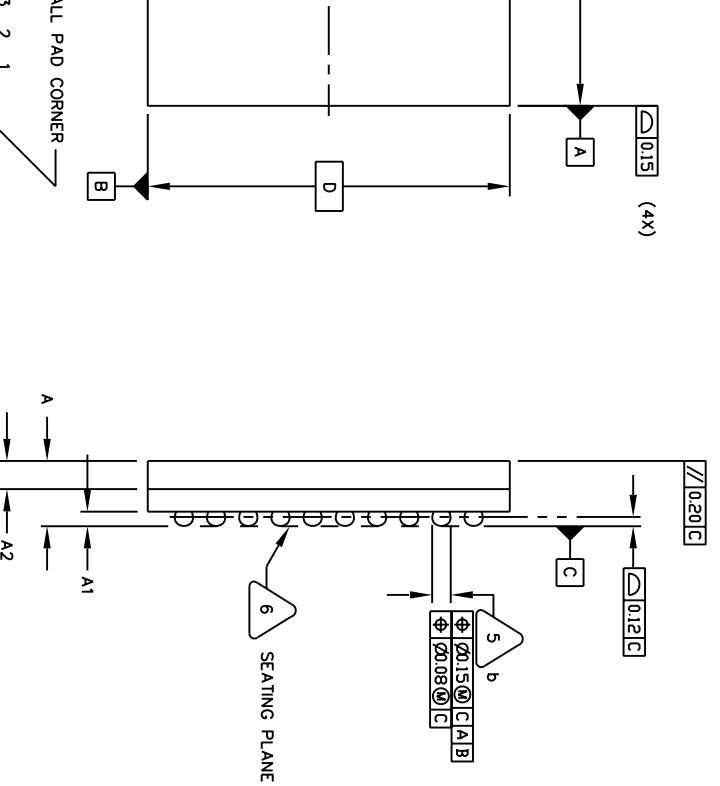
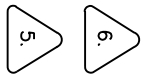

Figure 2 - Typical Application of the ZL30321



| SYMBOL | MILLIMETER |      |      |
|--------|------------|------|------|
|        | MIN        | NOM  | MAX  |
| A      | 1.52       | 1.62 | 1.72 |
| A1     | 0.31       | 0.36 | 0.41 |
| A2     | 0.65       | 0.70 | 0.75 |
| b      | 0.46 Typ.  |      |      |
| D      | 8.85       | 9.00 | 9.15 |
| E      | 8.85       | 9.00 | 9.15 |
| e      | 0.8 Ref    |      |      |
| n      | 100        |      |      |

**SIDE VIEW**



PRIMARY DATUM C AND SEATING PLANE ARE DEFINED BY THE SPHERICAL CROWNS OF THE SOLDER BALLS.  
 DIMENSION b IS MEASURED AT THE MAXIMUM SOLDER BALL DIAMETER, PARALLEL TO PRIMARY DATUM C.



DIMENSION b IS MEASURED AT THE MAXIMUM SOLDER BALL DIAMETER, PARALLEL TO PRIMARY DATUM C.

**BOTTOM VIEW**  
 100 SOLDER BALLS

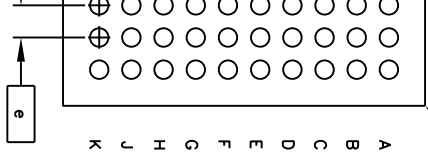

1. ALL DIMENSIONS AND TOLERANCES CONFORM TO ASME Y14.5M-1994.
  2. THE BASIC SOLDER BALL GRID PITCH IS 0.8mm.
  3. Not to Scale.
  4. THE MAXIMUM ALLOWABLE NUMBER OF SOLDER BALLS IS 100.
- NOTES: UNLESS OTHERWISE SPECIFIED

Package Code **GG**

Previous package codes  
 N/A  
 Package Outline for  
 100ball 9x9mm, 0.8 mm  
 Pitch, 4 layer, CABGA

111040





**For more information about all Zarlink products  
visit our Web Site at  
[www.zarlink.com](http://www.zarlink.com)**

Information relating to products and services furnished herein by Zarlink Semiconductor Inc. or its subsidiaries (collectively "Zarlink") is believed to be reliable. However, Zarlink assumes no liability for errors that may appear in this publication, or for liability otherwise arising from the application or use of any such information, product or service or for any infringement of patents or other intellectual property rights owned by third parties which may result from such application or use. Neither the supply of such information or purchase of product or service conveys any license, either express or implied, under patents or other intellectual property rights owned by Zarlink or licensed from third parties by Zarlink, whatsoever. Purchasers of products are also hereby notified that the use of product in certain ways or in combination with Zarlink, or non-Zarlink furnished goods or services may infringe patents or other intellectual property rights owned by Zarlink.

This publication is issued to provide information only and (unless agreed by Zarlink in writing) may not be used, applied or reproduced for any purpose nor form part of any order or contract nor to be regarded as a representation relating to the products or services concerned. The products, their specifications, services and other information appearing in this publication are subject to change by Zarlink without notice. No warranty or guarantee express or implied is made regarding the capability, performance or suitability of any product or service. Information concerning possible methods of use is provided as a guide only and does not constitute any guarantee that such methods of use will be satisfactory in a specific piece of equipment. It is the user's responsibility to fully determine the performance and suitability of any equipment using such information and to ensure that any publication or data used is up to date and has not been superseded. Manufacturing does not necessarily include testing of all functions or parameters. These products are not suitable for use in any medical products whose failure to perform may result in significant injury or death to the user. All products and materials are sold and services provided subject to Zarlink's conditions of sale which are available on request.

Purchase of Zarlink's I<sup>2</sup>C components conveys a license under the Philips I<sup>2</sup>C Patent rights to use these components in and I<sup>2</sup>C System, provided that the system conforms to the I<sup>2</sup>C Standard Specification as defined by Philips.

Zarlink, ZL, the Zarlink Semiconductor logo and the Legerity logo and combinations thereof, VoiceEdge, VoicePort, SLAC, ISLIC, ISLAC and VoicePath are trademarks of Zarlink Semiconductor Inc.

**TECHNICAL DOCUMENTATION - NOT FOR RESALE**

---

## Looking for pricing, stock, or lifecycle information?

Click below to explore more details on WIN SOURCE:

 [View ZL30321GGG2 on WIN SOURCE](#)

 [Microsemi Corporation](#) Information

## Optimize Your Supply Chain with WIN SOURCE Solutions

-  Global Sourcing Solution
-  Obsolete Management
-  Cost Control Management
-  Shortage Management
-  Alternative Solution
-  Excess Inventory Management