



THE DATASHEET OF ZC835ATA



830 series

Silicon 25V hyperabrupt varactor diodes

ZC829, ZDC833, ZMV829, ZMDC830 and ZV831

Description

A range of silicon varactor diodes for use in frequency control and filtering. Featuring closely controlled CV characteristics and high Q. Low reverse current ensures very low phase noise performance. Available in single or dual common cathode format in a wide range of miniature surface mount packages.

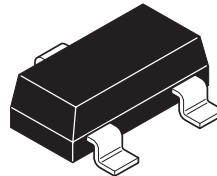

SOT23

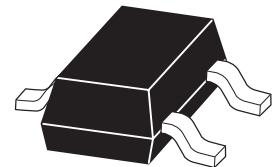

SOT323

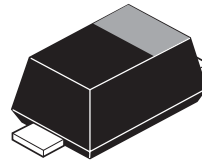

SOD523

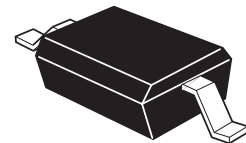

SOD323

Features

- Close tolerance CV characteristics
- High tuning ratio
- Low I_R (typically 200pA)
- Excellent phase noise performance
- High Q
- Range of miniature surface mount packages

Applications

- VCXO and TCXO
- Wireless communications
- Pagers
- Mobile radio

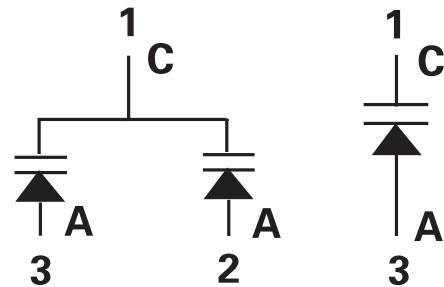

Where steeper CV slopes are required there is the 12V hyperabrupt range:

ZC930, ZMV930, ZV930 and ZV931

830 series

Order codes and device marking

SOT23		SOD323		SOD523		SOT23		SOT323	
Order code	Mark	Order code	Mark	Order code	Mark	Order code	Mark	Order code	Mark
ZC829ATA	J9A	ZMV829ATA	AA						
ZC829BTA	J9B	ZMV829BTA	CA						
ZC830ATA	J1A	ZMV830ATA	AB						
ZC830BTA	J1B	ZMV830BTA	CB						
ZC831ATA	J3A	ZMV831ATA	AC						
ZC831BTA	J3B	ZMV831BTA	CC	ZV831BV2TA	81			ZMDC831BTA	CC
ZC832ATA	J4A	ZMV832ATA	AD						
ZC832BTA	J4B	ZMV832BTA	CD	ZV832BV2TA	82			ZMDC832BTA	CD
ZC833ATA	J2A	ZMV833ATA	AE			ZDC833ATA	C2A		
ZC833BTA	J2B	ZMV833BTA	CE						
ZC834ATA	J5A	ZMV834ATA	AF			ZDC834ATA	C5A		
ZC834BTA	J5B	ZMV834BTA	CF						
ZC835ATA	J6A	ZMV835ATA	AG						
ZC835BTA	J6B	ZMV835BTA	CG						
ZC836ATA	J7A								
ZC836BTA	J7B								

Note:

The order codes are shown as TA which is for 7 inch reels. For 13 inch reels substitute TC in place of TA in the order code.

Tape and reel information

Reel code	Reel size (inches)	Tape width (millimeters)	Quantity per reel
TA	7	8	3,000
TC	13	8	10,000

830 series

Tuning characteristics at $T_{amb} = 25^{\circ}\text{C}$

Part	Capacitance (pF) $V_R=2V, f=1\text{MHz}$			Min Q $V_R = 3V$ $f = 50\text{MHz}$	Capacitance ratio C_2 / C_{20} @ $f = 1\text{MHz}$	
	Min.	Nom.	Max.		Min.	Max.
829A	7.38	8.2	9.02	250	4.3	5.8
829B	7.79	8.2	8.61	250	4.3	5.8
830A	9.0	10.0	11.0	300	4.5	6.0
830B	9.5	10.0	10.5	300	4.5	6.0
831A	13.5	15.0	16.5	300	4.5	6.0
831B	14.25	15.0	15.75	300	4.5	6.0
832A	19.8	22.0	24.2	200	5.0	6.5
832B	20.9	22.0	23.1	200	5.0	6.5
833A	29.7	33.0	36.3	200	5.0	6.5
833B	31.35	33.0	34.65	200	5.0	6.5
834A	42.3	47.0	51.7	200	5.0	6.5
834B	44.65	47.0	49.35	200	5.0	6.5
835A	61.2	68.0	74.8	100	5.0	6.5
835B	64.6	68.0	71.4	100	5.0	6.5
836A	90.0	100.0	110.0	100	5.0	6.5
836B	95.0	100.0	105.0	100	5.0	6.5

Absolute maximum ratings

Parameter	Symbol	Max.	Unit
Forward current	I_F	200	mA
Power dissipation at $T_{amb} = 25^{\circ}\text{C}$ SOT23	P_{tot}	330	mW
Power dissipation at $T_{amb} = 25^{\circ}\text{C}$ SOD323	P_{tot}	330	mW
Power dissipation at $T_{amb} = 25^{\circ}\text{C}$ SOD523	P_{tot}	250	mW
Operating and storage temperature range		-55 to +150	$^{\circ}\text{C}$

Electrical characteristics at $T_{amb} = 25^{\circ}\text{C}$

Parameter	Conditions	Min.	Typ.	Max.	Unit
Reverse breakdown voltage	$I_R = 10\mu\text{A}$	25			V
Reverse voltage leakage	$V_R = 20V$		0.2	20	nA
Temperature coefficient of capacitance	$V_R = 3V, f = 1\text{MHz}$		300	400	ppCm/ $^{\circ}\text{C}$

830 series

Typical characteristics

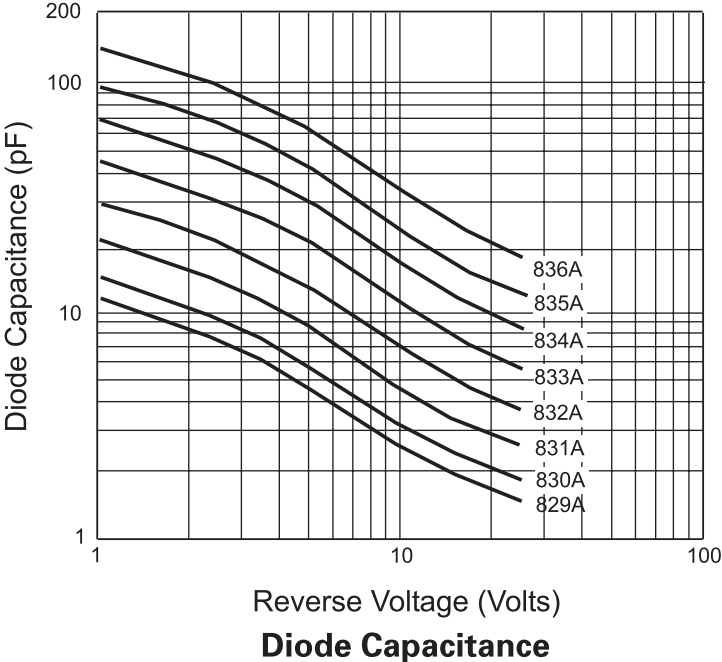

830 series

Package outline - SOT23

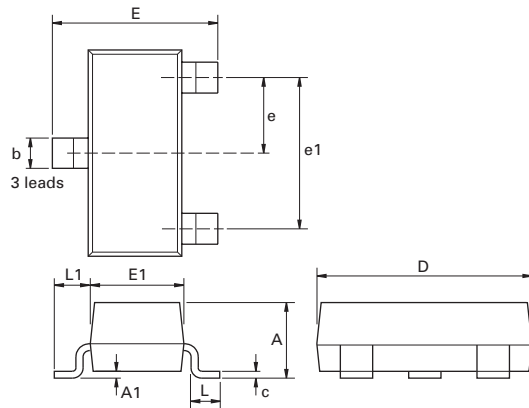

Dim.	Millimeters		Inches		Dim.	Millimeters		Inches	
	Min.	Max.	Min.	Max.		Min.	Max.	Max.	Max.
A	2.67	3.05	0.105	0.120	H	0.33	0.51	0.013	0.020
B	1.20	1.40	0.047	0.055	K	0.01	0.10	0.0004	0.004
C	-	1.10	-	0.043	L	2.10	2.50	0.083	0.0985
D	0.37	0.53	0.015	0.021	M	0.45	0.64	0.018	0.025
F	0.085	0.15	0.0034	0.0059	N	0.95 NOM		0.0375 NOM	
G	1.90 NOM		0.075 NOM		-	-	-	-	-

Note: Controlling dimensions are in millimeters. Approximate dimensions are provided in inches

Package outline - SOT323

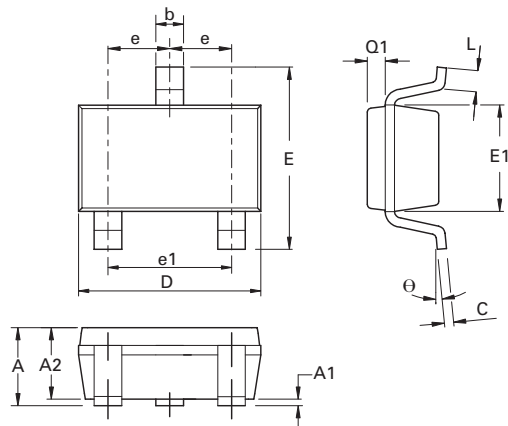

Dim.	Millimeters		Inches		Dim.	Millimeters		Inches	
	Min.	Max.	Min.	Max.		Min.	Max.	Max.	Max.
A	0.80	1.10	0.0315	0.0433	E1	1.15	1.35	0.0453	0.0532
A1	0	0.10	0	0.0039	e	0.65 BSC		0.0256 BSC	
A2	0.80	1.00	0.0315	0.394	e1	1.30 BSC		0.0512 BSC	
b	0.25	0.40	0.0098	0.0158	L	0.10	0.30	0.0039	0.0118
C	0.10	0.26	0.0039	0.0102	Q1	0.10	0.40	0.0039	0.0158
D	1.80	2.20	0.0709	0.0866	theta	0°	30°	0°	30°
E	1.80	2.40	0.0709	0.0945	-	-	-	-	-

Note: Controlling dimensions are in millimeters. Approximate dimensions are provided in inches

830 series

Package outline - SOD523

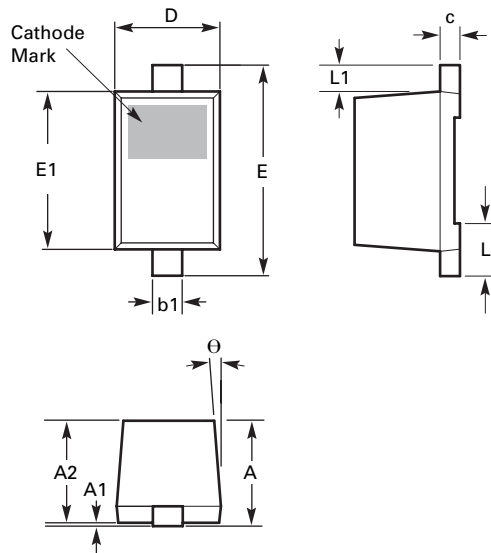

DIM	Millimeters		Inches		DIM	Millimeters		Inches	
	Min.	Max.	Min.	Max.		Min.	Max.	Min.	Max.
A	-	0.800	-	0.0314	E	1.500	1.700	0.0590	0.0669
A1	0.000	0.100	0.000	0.0039	E1	1.100	1.300	0.0433	0.0511
A2	0.600	0.800	0.0236	0.0314	L	0.200	0.400	0.0078	0.0157
b1	0.160	0.300	0.0062	0.0118	L1	0.170	0.230	0.0066	0.0090
c	0.080	0.220	0.0031	0.0086	U	4°	10°	4°	10°
D	0.700	0.900	0.0275	0.0354	-	-	-	-	-

Note: Controlling dimensions are in millimeters. Approximate dimensions are provided in inches

830 series

Package outline - SOD323

Top mark

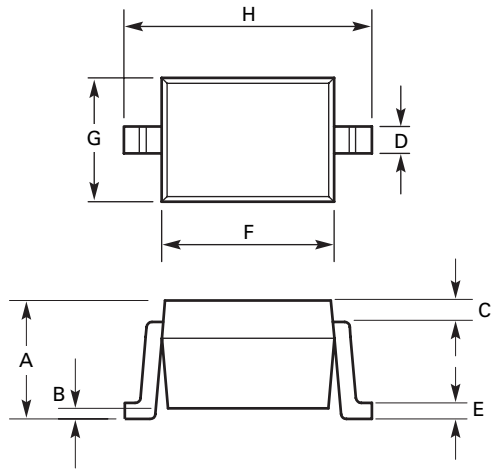
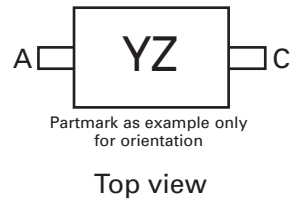

DIM	Millimeters		DIM	Millimeters	
	Min.	Max.		Min.	Max.
A	0.91	1.16	E	0.127	0.200
B	0.00	0.10	F	1.52	1.77
C	-	-	G	1.11	1.37
D	0.33	0.40	H	2.46	2.71

Definitions

Product change

Zetex Semiconductors reserves the right to alter, without notice, specifications, design, price or conditions of supply of any product or service. Customers are solely responsible for obtaining the latest relevant information before placing orders.

Applications disclaimer

The circuits in this design/application note are offered as design ideas. It is the responsibility of the user to ensure that the circuit is fit for the user's application and meets with the user's requirements. No representation or warranty is given and no liability whatsoever is assumed by Zetex with respect to the accuracy or use of such information, or infringement of patents or other intellectual property rights arising from such use or otherwise. Zetex does not assume any legal responsibility or will not be held legally liable (whether in contract, tort (including negligence), breach of statutory duty, restriction or otherwise) for any damages, loss of profit, business, contract, opportunity or consequential loss in the use of these circuit applications, under any circumstances.

Life support

Zetex products are specifically not authorized for use as critical components in life support devices or systems without the express written approval of the Chief Executive Officer of Zetex Semiconductors plc. As used herein:

A. Life support devices or systems are devices or systems which:

1. are intended to implant into the body

or

2. support or sustain life and whose failure to perform when properly used in accordance with instructions for use provided in the labelling can be reasonably expected to result in significant injury to the user.

B. A critical component is any component in a life support device or system whose failure to perform can be reasonably expected to cause the failure of the life support device or to affect its safety or effectiveness.

Reproduction

The product specifications contained in this publication are issued to provide outline information only which (unless agreed by the company in writing) may not be used, applied or reproduced for any purpose or form part of any order or contract or be regarded as a representation relating to the products or services concerned.

Terms and Conditions

All products are sold subjects to Zetex' terms and conditions of sale, and this disclaimer (save in the event of a conflict between the two when the terms of the contract shall prevail) according to region, supplied at the time of order acknowledgement.

For the latest information on technology, delivery terms and conditions and prices, please contact your nearest Zetex sales office.

Quality of product

Zetex is an ISO 9001 and TS16949 certified semiconductor manufacturer.

To ensure quality of service and products we strongly advise the purchase of parts directly from Zetex Semiconductors or one of our regionally authorized distributors. For a complete listing of authorized distributors please visit: www.zetex.com/salesnetwork

Zetex Semiconductors does not warrant or accept any liability whatsoever in respect of any parts purchased through unauthorized sales channels.

ESD (Electrostatic discharge)

Semiconductor devices are susceptible to damage by ESD. Suitable precautions should be taken when handling and transporting devices. The possible damage to devices depends on the circumstances of the handling and transporting, and the nature of the device. The extent of damage can vary from immediate functional or parametric malfunction to degradation of function or performance in use over time. Devices suspected of being affected should be replaced.

Green compliance

Zetex Semiconductors is committed to environmental excellence in all aspects of its operations which includes meeting or exceeding regulatory requirements with respect to the use of hazardous substances. Numerous successful programs have been implemented to reduce the use of hazardous substances and/or emissions.

All Zetex components are compliant with the RoHS directive, and through this it is supporting its customers in their compliance with WEEE and ELV directives.

Product status key:

"Preview"	Future device intended for production at some point. Samples may be available
"Active"	Product status recommended for new designs
"Last time buy (LTB)"	Device will be discontinued and last time buy period and delivery is in effect
"Not recommended for new designs"	Device is still in production to support existing designs and production
"Obsolete"	Production has been discontinued

Datasheet status key:

"Draft version"	This term denotes a very early datasheet version and contains highly provisional information, which may change in any manner without notice.
"Provisional version"	This term denotes a pre-release datasheet. It provides a clear indication of anticipated performance. However, changes to the test conditions and specifications may occur, at any time and without notice.
"Issue"	This term denotes an issued datasheet containing finalized specifications. However, changes to specifications may occur, at any time and without notice.

Zetex sales offices

Europe	Americas	Asia Pacific	Corporate Headquarters
Zetex GmbH Kustermann-park Balanstraße 59 D-81541 München Germany Telephone: (49) 89 45 49 49 0 Fax: (49) 89 45 49 49 49 europe.sales@zetex.com	Zetex Inc 700 Veterans Memorial Highway Hauppauge, NY 11788 USA Telephone: (1) 631 360 2222 Fax: (1) 631 360 8222 usa.sales@zetex.com	Zetex (Asia Ltd) 3701-04 Metroplaza Tower 1 Hing Fong Road, Kwai Fong Hong Kong Telephone: (852) 26100 611 Fax: (852) 24250 494 asia.sales@zetex.com	Zetex Semiconductors plc Zetex Technology Park, Chadderton Oldham, OL9 9LL United Kingdom Telephone: (44) 161 622 4444 Fax: (44) 161 622 4446 hq@zetex.com

© 2007 Published by Zetex Semiconductors plc

Looking for pricing, stock, or lifecycle information?

Click below to explore more details on WIN SOURCE:

-  [View ZC835ATA on WIN SOURCE](#)
-  [Diodes Incorporated Information](#)

Optimize Your Supply Chain with WIN SOURCE Solutions

-  Global Sourcing Solution
-  Obsolete Management
-  Cost Control Management
-  Shortage Management
-  Alternative Solution
-  Excess Inventory Management