

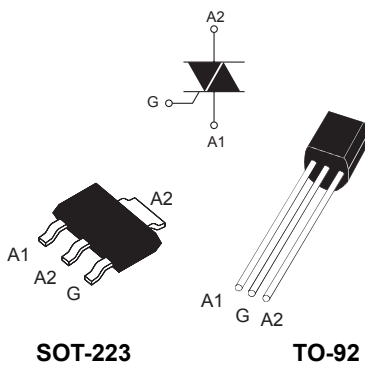

**THE DATASHEET OF  
Z0103NA 2AL2**



## Standard 1 A Triacs



## Features

- On-state rms current,  $I_{T(RMS)}$  1 A
- Repetitive peak off-state voltage,  $V_{DRM}/V_{RRM}$  600 or 800 V
- Triggering gate current,  $I_{GT(Q1)}$  3 to 25 mA

## Applications

- AC switching
- Home appliances

## Description

The Z01 series is suitable for general purpose AC switching applications. These devices are typically used in applications such as home appliances (electrovalve, pump, door lock, small lamp control), fan speed controllers,...

Different gate current sensitivities are available, allowing optimized performance when driven directly through microcontroller.

## Product status link

[Z01](#)

## Product summary

$I_{T(RMS)}$	1 A
$V_{DRM}/V_{RRM}$	600, 800 V
$I_{GTstandard}$	3 to 25 mA

# 1 Characteristics

**Table 1. Absolute maximum ratings**

Symbol	Parameters	Value	Unit	
$I_{T(RMS)}$	RMS on-state current (full sine wave)	SOT-223 $T_{tab} = 90\text{ °C}$	1	A
		TO-92 $T_L = 50\text{ °C}$		
		SMBflat-3L $T_{tab} = 107\text{ °C}$		
$I_{TSM}$	Non repetitive surge peak on-state current (full cycle, $T_j$ initial = 25 °C)	F = 50 Hz $t_p = 20\text{ ms}$	8	A
		F = 60 Hz $t_p = 16.7\text{ ms}$	8.5	
$I^2t$	$I^2t$ value for fusing	$t_p = 10\text{ ms}$	0.35	$A^2s$
$di/dt$	Critical rate of rise of on-state current $I_G = 2 \times I_{GT}$ , $t_r \leq 100\text{ ns}$	F = 120 Hz $T_j = 125\text{ °C}$	20	$A/\mu s$
$I_{GM}$	Peak gate current	$t_p = 20\text{ }\mu s$ $T_j = 125\text{ °C}$	1	A
$P_{G(AV)}$	Average gate power dissipation	$T_j = 125\text{ °C}$	1	W
$T_{stg}$	Storage junction temperature range		-40 to +150	°C
$T_j$	Operating junction temperature range		-40 to +125	°C

**Table 2. Electrical characteristics ( $T_j = 25\text{ °C}$ , unless otherwise specified)**

Symbol	Parameters	Quadrant		Value				Unit
				Z01				
				03	07	09	10	
$I_{GT}^{(1)}$	$V_D = 12\text{ V}$ , $R_L = 30\text{ }\Omega$	I - II - III	Max.	3	5	10	25	mA
		IV		5	7	10	25	
$V_{GT}$		All	Max.	1.3				V
$V_{GD}$	$V_D = V_{DRM}$ , $R_L = 3.3\text{ k}\Omega$ , $T_j = 125\text{ °C}$	All	Min.	0.2				V
$I_H^{(2)}$	$I_T = 50\text{ mA}$		Max.	7	10	10	25	mA
$I_L$	$I_G = 1.2 I_{GT}$	I - III - IV	Max.	7	10	15	25	mA
		II	Max.	15	20	25	50	
$dV/dt^{(2)}$	$V_D = 67\% V_{DRM}$ gate open, $T_j = 110\text{ °C}$		Min.	10	20	50	100	$V/\mu s$
$(dV/dt)_c^{(2)}$	$(di/dt)_c = 0.44\text{ A/ms}$ , $T_j = 110\text{ °C}$		Min.	0.5	1	2	5	$V/\mu s$

1. Minimum  $I_{GT}$  is guaranteed at 5% of  $I_{GT}$  max.

2. For both polarities of A2 referenced to A1

**Table 3. Static electrical characteristics**

Symbol	Test conditions	$T_j$		Value	Unit
$V_T^{(1)}$	$I_{TM} = 1.4 \text{ A}$ , $t_p = 380 \mu\text{s}$	25 °C	Max.	1.60	V
$V_{TO}^{(1)}$	Threshold on-state voltage	125 °C	Max.	0.95	V
$R_d$	Dynamic resistance	125 °C	Max.	400	mΩ
$I_{DRM}$ $I_{RRM}$	$V_{DRM} = V_{RRM}$	25 °C	Max.	5	μA
		125 °C		0.5	mA

1. For both polarities of A2 referenced to A1

**Table 4. Thermal resistance**

Symbol	Parameters		Max. value	Unit
$R_{th(j-t)}$	Max. junction to tab (AC)	SOT-223	25	°C/W
		SMBflat-3L	14	
$R_{th(j-l)}$	Max. junction to lead (AC)	TO-92	60	
$R_{th(j-a)}$	Junction to ambient ( $S^{(1)} = 5 \text{ cm}^2$ )	SOT-223	60	
		SMBflat-3L	75	
	Junction to ambient	TO-92	150	

1. Copper surface under tab.

### 1.1 Characteristics (curves)

**Figure 1. Maximum power dissipation versus on-state RMS current (full cycle)**

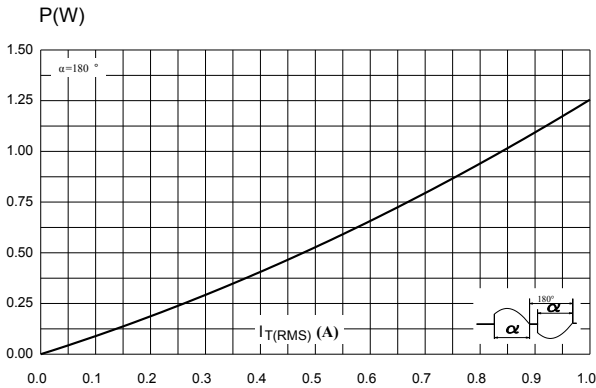

**Figure 2. RMS on-state current versus lead (TO-92) or tab (SOT-223, SMBflat-3L) temperature (full cycle)**

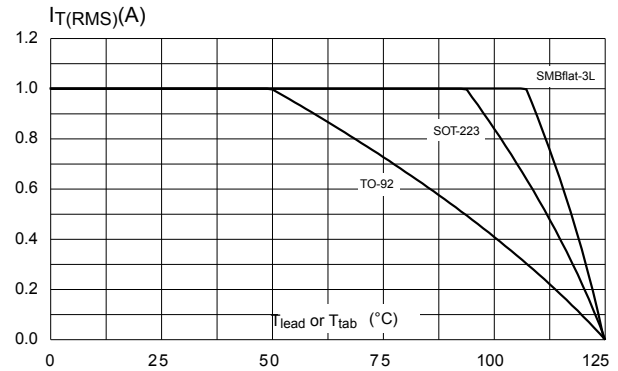

**Figure 3. On-state rms current versus ambient temperature (free air convection full cycle)**

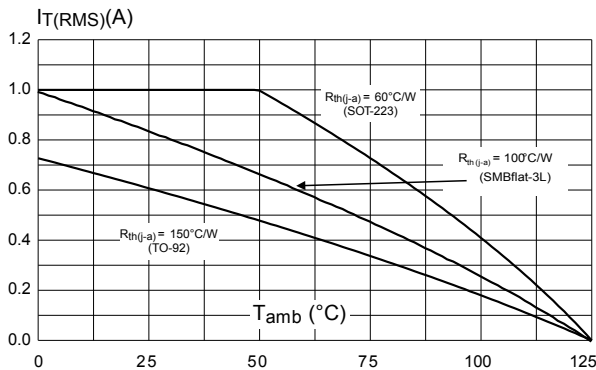

**Figure 4. Relative variation of thermal impedance versus pulse duration ( $Z_{th(j-a)}$ )**

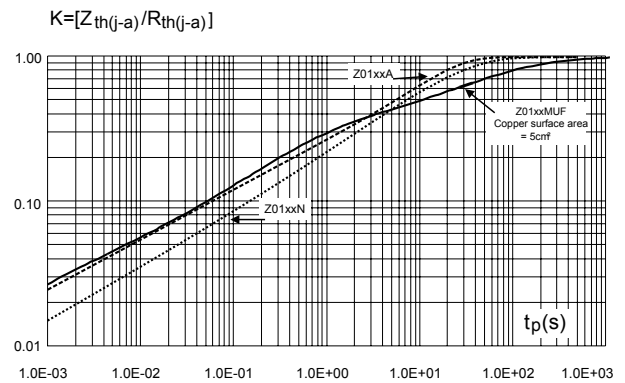

**Figure 5. Relative variation of holding current and latching current versus junction temperature (typ. values)**

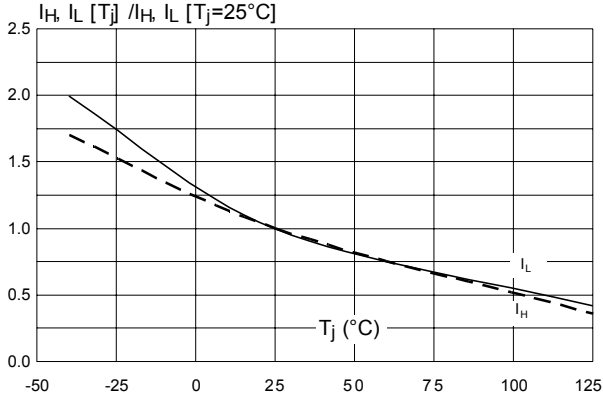

**Figure 6. Relative variation of gate trigger current ( $I_{GT}$ ) and voltage ( $V_{GT}$ ) versus junction temperature**

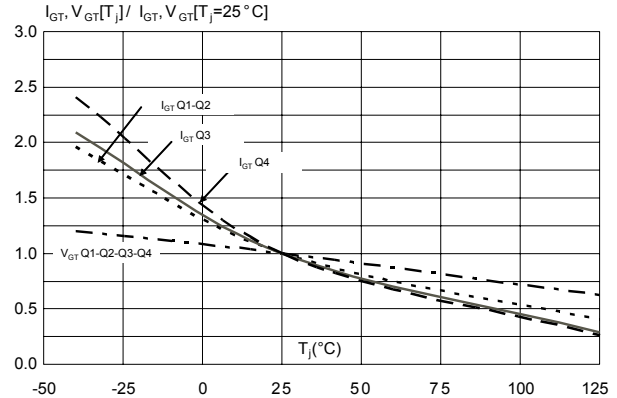

**Figure 7. Surge peak on-state current versus number of cycles**

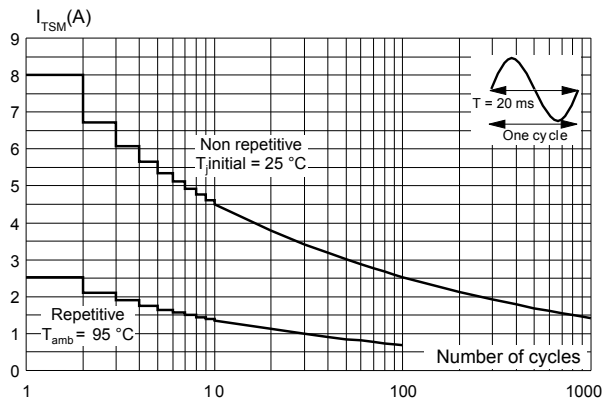

**Figure 8. Non-repetitive surge peak on-state current and corresponding value of  $I^2t$  sinusoidal pulse width**

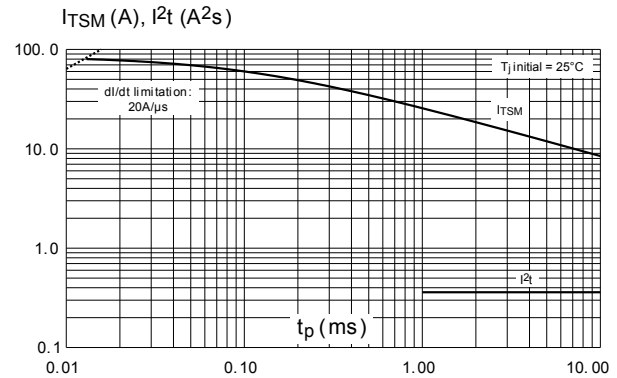

**Figure 9. On-state characteristics (maximum values) ( $I_{TM} = f(V_{TM})$ )**

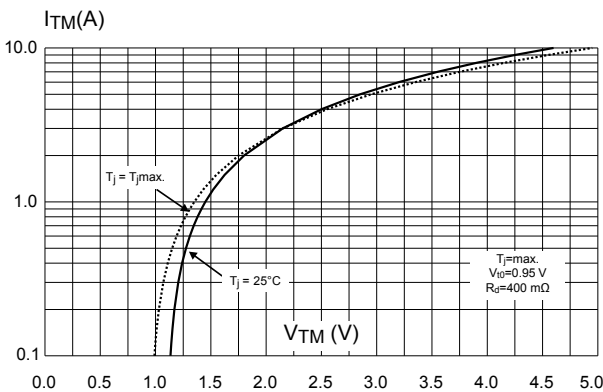

**Figure 10. Relative variation of critical rate of decrease of main current ( $dI/dt$ ) versus junction temperature**

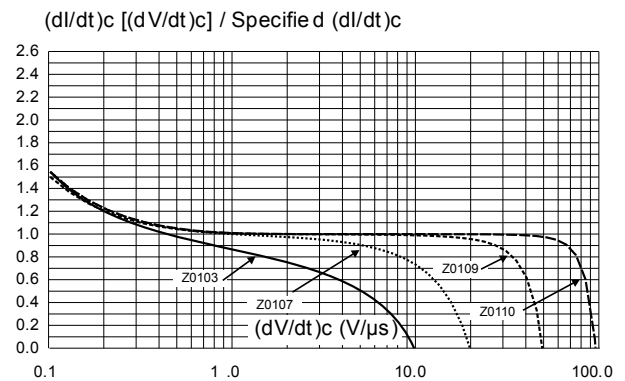

**Figure 11. Relative variation of critical rate of decrease of main current (dI/dt) versus junction temperature**

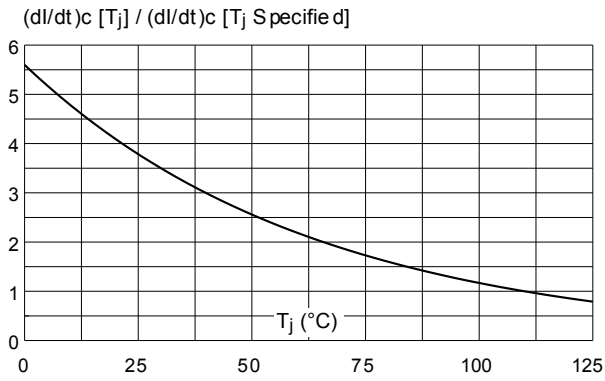

**Figure 12. SOT-223 and SMBflat-3L thermal resistance junction to ambient versus copper surface under case**

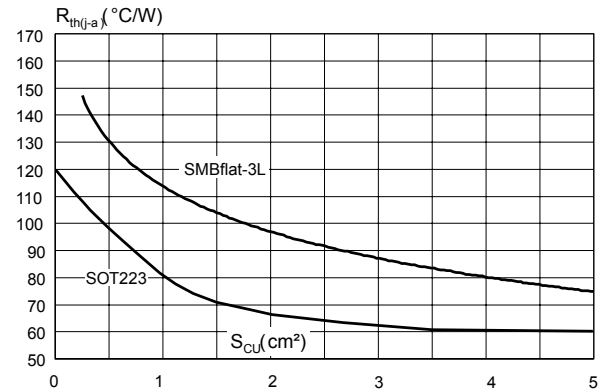

**Figure 13. Relative variation of static dV/dt immunity versus junction temperature (gate open)**

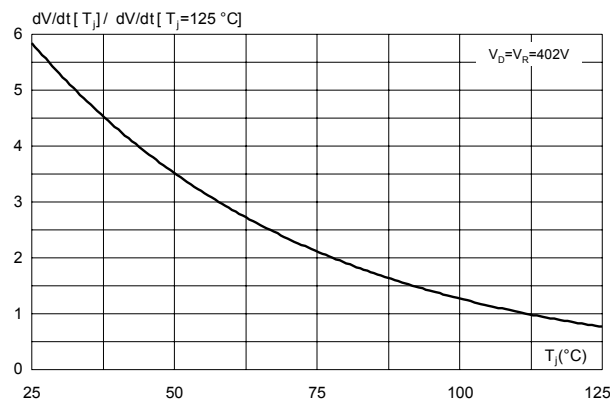

## 2 Package information

In order to meet environmental requirements, ST offers these devices in different grades of **ECOPACK** packages, depending on their level of environmental compliance. ECOPACK specifications, grade definitions and product status are available at: [www.st.com](http://www.st.com). ECOPACK is an ST trademark.

### 2.1 SOT-223 package information

- Epoxy meets UL94, V0
- Lead free plating + halogen-free molding resin

Figure 14. SOT-223 package outline

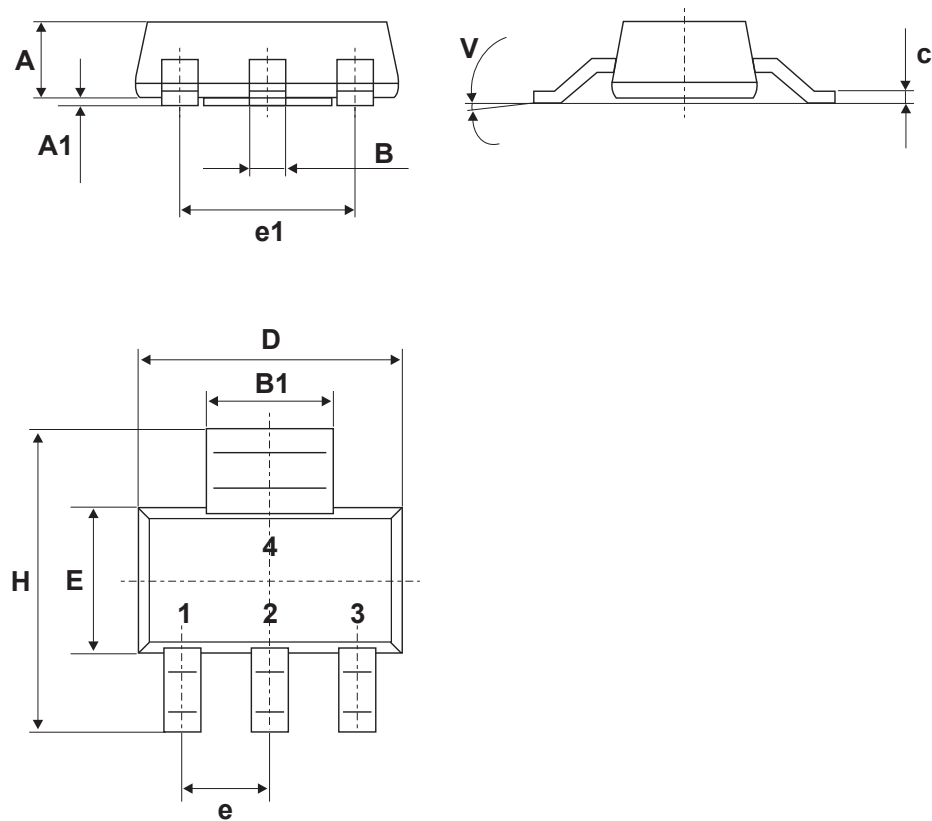

**Table 5. SOT-223 package mechanical data**

Ref.	Dimensions					
	Millimeters			Inches <sup>(1)</sup>		
	Min.	Typ.	Max.	Min.	Typ.	Max.
A			1.80			0.0709
A1		0.02	0.10		0.0008	0.0039
B	0.60	0.70	0.85	0.024	0.0276	0.0335
B1	2.90	3.00	3.15	0.114	0.1181	0.1240
c	0.24	0.26	0.35	0.009	0.0102	0.0138
D	6.30	6.50	6.70	0.248	0.2559	0.2638
e		2.3			0.0906	
e1		4.6			0.1811	
E	3.30	3.50	3.70	0.130	0.1378	0.1457
H	6.70	7.00	7.30	0.264	0.2756	0.2874
V	10° max.					

1. Inches only for reference

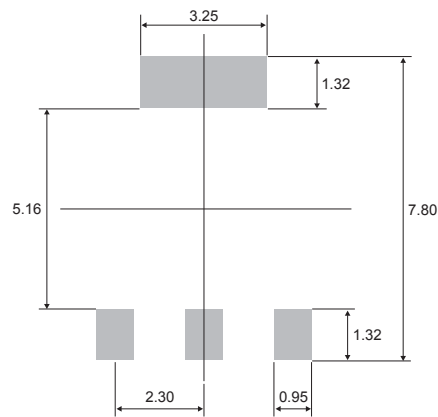
**Figure 15. SOT-223 footprint (dimensions in mm)**

## 2.2 TO-92 package information

- Epoxy meets UL94, V0
- Lead free plating + halogen-free molding resin

Figure 16. TO-92 package outline

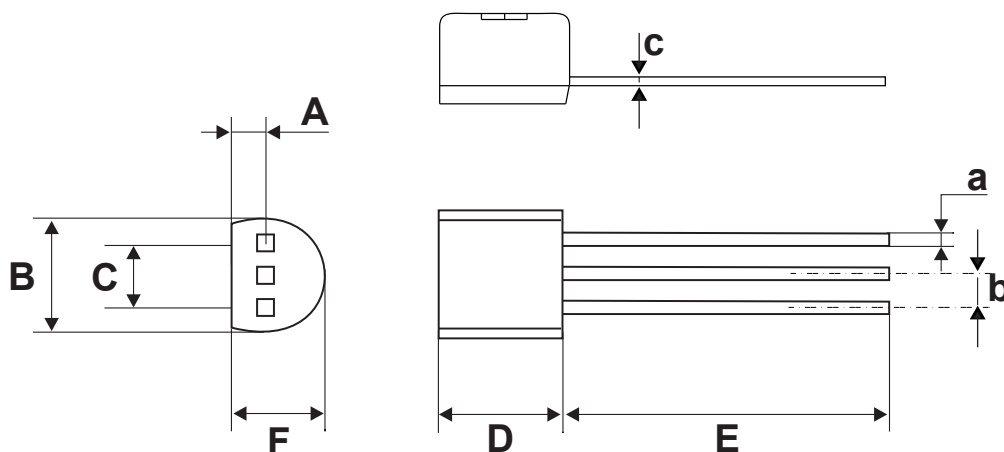

Table 6. TO-92 package mechanical data

Ref.	Dimensions					
	Millimeters			Inches <sup>(1)</sup>		
	Min.	Typ.	Max.	Min.	Typ.	Max.
A		1.35			0.0531	
B			4.70			0.1850
C		2.54			0.1000	
D	4.40			0.1732		
E	12.70			0.5000		
F			3.70			0.1457
a			0.50			0.0197
b		1.27			0.500	
c			0.48			0.0189

1. Inches dimensions given for information

### 2.3 SMBflat-3L package information

- Epoxy meets UL94, V0
- Lead-free package

**Figure 17. SMBflat-3L package outline**

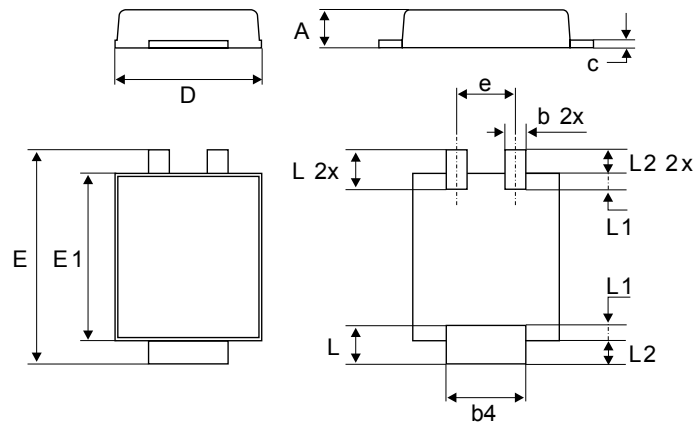

**Table 7. SMBflat-3L mechanical data**

Ref.	Dimensions					
	Millimeters			Inches		
	Min.	Typ.	Max.	Min.	Typ.	Max.
A	0.90		1.10	0.035		0.044
b	0.35		0.65	0.014		0.026
b4	1.95		2.20	0.070		0.087
c	0.15		0.40	0.005		0.016
D	3.30		3.95	0.129		0.156
E	5.10		5.60	0.200		0.221
E1	4.05		4.60	0.159		0.182
L	0.75		1.50	0.029		0.060
L1		0.40			0.016	
L2		0.60			0.024	
e		1.60			0.063	



### 3 Ordering information

Figure 20. Ordering information scheme

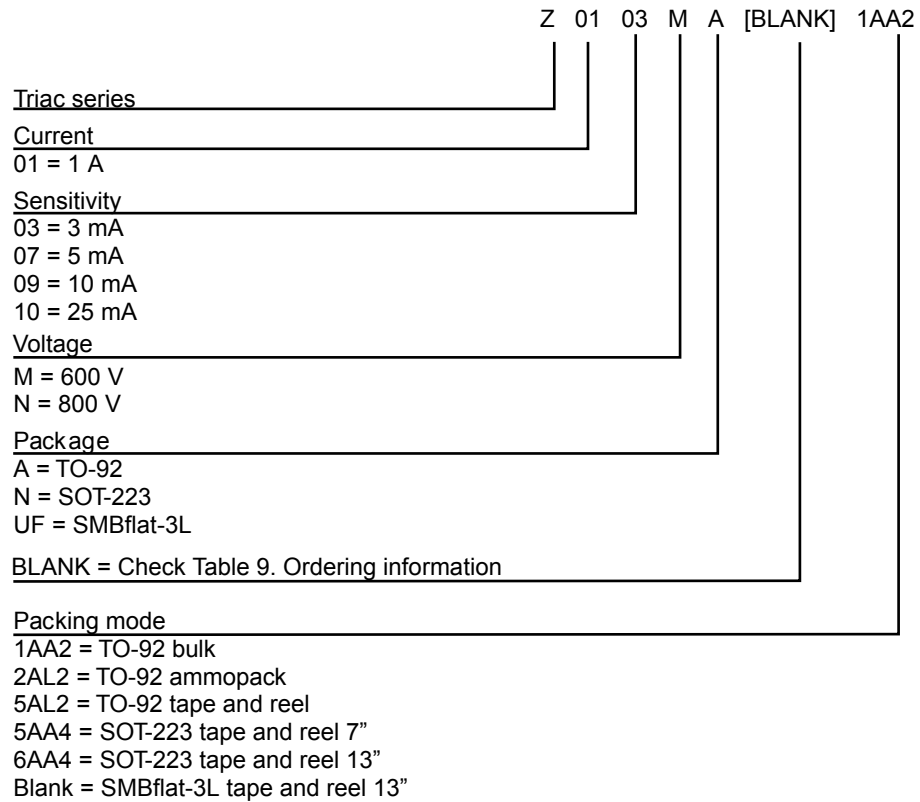

### 3.1 Product selector

**Table 8. Product selector**

Part Number		Sensitivity	Type	Package
600	800			
Z0103MA	Z0103NA	3 mA	Standard	TO-92
Z0103MN	Z0103NN			SOT-223
Z0107MA	Z0107NA	5 mA		TO-92
Z0107MN	Z0107NN			SOT-223
Z0109MA	Z0109NA	10 mA		TO-92
Z0109MN	Z0109NN			SOT-223
Z0110MA	Z0110NA	25 mA		TO-92
Z0110MN	Z0110NN			SOT-223
Z0103MUF		3 mA		SMBflat-3L
Z0107MUF		5 mA		
Z0109MUF		10 mA		

### 3.2 Ordering information

Table 9. Ordering information

Order code <sup>(1)</sup>	Marking <sup>(1)</sup>	Package	Weight	Base qty.	Delivery mode		
Z01xyA 1AA2	Z01xyA	TO-92	0.2 g	2500	Bulk		
Z01xyA 2AL2				2000	Ammopack		
Z01xyA 5AL2				2000	Tape and reel		
Z0103yN 5AA4	Z3y	SOT-223	0.12 g	1000			
Z0103MN 6AA4	Z3M			4000			
Z0107yN 5AA4	Z7y			1000			
Z0107MN 6AA4	Z7M			4000			
Z0109yN 5AA4	Z9y			1000			
Z0109NN6AA4	Z9N			4000			
Z0103MUF	Z3M			SMBflat-3L		46.78 mg	5000
Z0107MUF	Z7M						5000
Z0109MUF	Z9M						5000

1. xx = sensitive, y = voltage, and check [Figure 20. Ordering information scheme](#).

## Revision history

**Table 10. Document revision history**

Date	Revision	Changes
Oct-2001	4	Last update.
10-Feb-2005	5	Package: TO-92 tape and reel delivery mode 5AL2 added.
09-May-2005	6	Table 4 on page 2: typo. mistake corrected 1. (dV/dt)c instead of (dI/dt)c 2. V/ $\mu$ s unit instead of A/ms
21-Apr-2006	7	Reformatted to current standard. Table 2 on page 2: Typo corrected. Values for IGT split into two separate rows.
10-Oct-2010	8	Table 2: modified test conditions for (dV/dt)c. Changed "ambient" to "lead or tab" in Figure 2.
20-Oct-2010	9	Package: SOT-223 13" tape and reel added = 6AA4.
14-Dec-2010	10	Added package SMBflat-3L. Updated dimensions in Table 6. Updated Figure 3 and Figure 12. Updated Table 5: Product Selector.
02-May-2019	11	Updated <a href="#">Table 9. Ordering information</a> . Minor text changed.

**IMPORTANT NOTICE – PLEASE READ CAREFULLY**

STMicroelectronics NV and its subsidiaries (“ST”) reserve the right to make changes, corrections, enhancements, modifications, and improvements to ST products and/or to this document at any time without notice. Purchasers should obtain the latest relevant information on ST products before placing orders. ST products are sold pursuant to ST’s terms and conditions of sale in place at the time of order acknowledgement.

Purchasers are solely responsible for the choice, selection, and use of ST products and ST assumes no liability for application assistance or the design of Purchasers’ products.

No license, express or implied, to any intellectual property right is granted by ST herein.

Resale of ST products with provisions different from the information set forth herein shall void any warranty granted by ST for such product.



ST and the ST logo are trademarks of ST. For additional information about ST trademarks, please refer to [www.st.com/trademarks](http://www.st.com/trademarks). All other product or service names are the property of their respective owners.

Information in this document supersedes and replaces information previously supplied in any prior versions of this document.

© 2019 STMicroelectronics – All rights reserved

## Looking for pricing, stock, or lifecycle information?

Click below to explore more details on WIN SOURCE:

-  [View Z0103NA 2AL2 on WIN SOURCE](#)
-  [STMicroelectronics](#) Information

## Optimize Your Supply Chain with WIN SOURCE Solutions

-  Global Sourcing Solution
-  Obsolete Management
-  Cost Control Management
-  Shortage Management
-  Alternative Solution
-  Excess Inventory Management