



**THE DATASHEET OF
AAT4685IWP-1-T1**



Over-Voltage Protection Switch with OCP and BOVP

General Description

The AAT4685 OVPSwitch™ is a member of Skyworks' Application Specific Power MOSFET™ (ASPM™) product family. It is an N-channel MOSFET power switch with precise over-voltage protection control, designed to protect low-voltage systems against high-voltage faults up to +28V. It also integrates over-current protection (OCP), battery over-voltage protection (BOVP) and over-temperature protection (OTP).

When the input voltage exceeds the programmed over-voltage threshold, the N-channel MOSFET switch will be turned off to prevent damage to the output load circuits. An external resistor divider is adopted to program the adjustable version over-voltage trip point. Over-current protection protects the case of output short circuits by disconnecting the load from the input supply.

A battery voltage monitor is integrated and disconnect the IN and OUT when the battery voltage exceed its rated voltage. The AAT4685 also monitors its own die temperature and OVP switch off if it becomes too hot.

The AAT4685 includes an under-voltage lockout (UVLO) protection circuit, which puts the device into sleep mode at low input voltages only consuming 100µA current. It also includes two indicators: input supply power good indicator (POK) which is always active whether EN is low or high, and a fault flag indicator (FLT) which goes to active low when a fault condition (OV, OC, BOV and OT) occurs at EN = low.

The AAT4685 is offered in a Pb-free, 3x3mm 12-pin TDFN package with a pin-out optimized for safety and is specified for operation over the -40°C to +85°C ambient temperature range.

Features

- V_{IN} Range: 3.0V – 28V
- OVP Threshold Setting Range: 4V – 7V
 - Fixed: 5.85V and 6.8V
 - Adjustable
- Fast OVP Response: 1µs (max) Response to Over-Voltage Transient
- OVP Recovery Delay Time: 8ms
- Over-Current Protection
 - Adjustable 0.3 – 1.8A
- Battery OVP 4.35V
- Thermal Shutdown Protection
- Low Quiescent Current
 - 600µA Typical
 - 100µA Typical Standby Current
- Under-Voltage Lockout
- 120mΩ Typical $R_{DS(ON)}$ at 5.0V
- Active Low Enable with Internal 200kΩ Pull-Down Resistor
- Input Supply Power Good Indicator, Open Drain
- OVP/OCP/BOVP/OT Fault Indicator, Open Drain
- Temperature Range: -40°C to 85°C
- 3x3mm TDFN-12 Package

Applications

- Cell Phones
- Digital Still Cameras
- MP3
- Personal Data Assistants (PDAs)

Typical Application

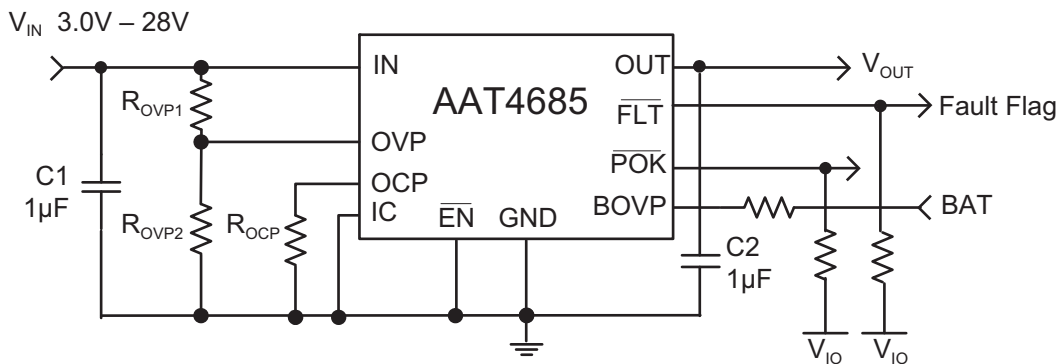

AAT4685

Over-Voltage Protection Switch with OCP and BOVP

Pin Descriptions

Pin #	Symbol	Function
1	OCP	Over-current protection threshold input. Connect resistor to ground to set OCP limit.
2	IC	Internally connected. Connect this pin to ground.
3	\overline{EN}	Active low enable with internal 200k Ω resistor pull down to GND
4	\overline{POK}	Input supply power-good status pin, open-drain. The \overline{POK} function is always active whether \overline{EN} is low or high. Connect a 1k Ω to 100k Ω pull-up resistor to the logic I/O voltage of the host system.
5,6	OUT	Output. Connect a 0.1 μ F~47 μ F capacitor from OUT to GND.
7,8	IN	Power input pin. Connect 1 μ F capacitor from IN to GND.
9	GND	Ground connection.
10	\overline{FLT}	Open-drain output. Active low when input over-voltage, input over-current, battery over-voltage, or over temperature and EN = low. The \overline{FLT} pin goes to high impedance state when EN = high. Connect a 1k Ω to 100k Ω pull-up resistor to the logic I/O voltage of the host system.
11	BOVP	Battery voltage sense input. Connect to battery positive terminal through a 100k Ω resistor to limit the current in case of a short circuit condition.
12	OVP (N/C)	Over-voltage protection threshold input (Adjustable only). Fixed version not connected.

Pin Configuration

**TDFN33-12
(Top View)**

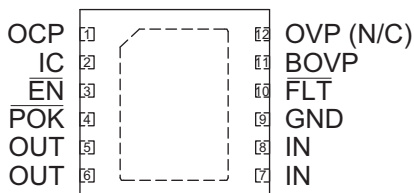

AAT4685**Over-Voltage Protection Switch with OCP and BOVP****Absolute Maximum Ratings¹**

Symbol	Description	Value	Units
V_{IN}	IN to GND	-0.3 to 28	V
V_N	BOVP, OVP, OCP, OUT, IC to GND	-0.3 to $V_p + 0.3$	V
V_P	FLT, EN, POK to GND	-0.3 to 7.5	V
I_{MAX}	Maximum Continuous Switch Current	1.9	A
T_J	Operating Junction Temperature Range	-40 to 150	°C
T_S	Storage Temperature Range	-65 to 150	°C
T_{LEAD}	Maximum Soldering Temperature (at leads, 10 sec)	300	°C

Thermal Characteristics

Symbol	Description	Value	Units
Θ_{JA}	Maximum Thermal Resistance ²	50	°C/W
P_D	Maximum Power Dissipation ^{2, 3}	2	W

1. Stresses above those listed in Absolute Maximum Ratings may cause permanent damage to the device. Functional operation at conditions other than the operating conditions specified is not implied. Only one Absolute Maximum Rating should be applied at any one time.

2. Mounted on a FR4 board.

3. Derate 25mW/°C above 25°C.

DATA SHEET

AAT4685

Over-Voltage Protection Switch with OCP and BOVP

Electrical Characteristics¹

$V_{IN} = 5V$, $V_{BOVP} = 4.2V$, $V_{EN} = 0V$, $R_{OCP} = 30k\Omega$, $T_A = -40^\circ C$ to $85^\circ C$ unless otherwise noted. Typical values are at $T_A = 25^\circ C$.

Symbol	Description	Conditions	Min	Typ	Max	Units	
V_{IN}	Input Voltage Range		3		28	V	
I_Q	Operation Quiescent Current	$I_{OUT} = 0$, $R_{OCP} = 30k\Omega$		600	800	μA	
I_{STDBY}	Standby Current (Only UVLO and OVP circuit is "Enable", other function blocks are all "Disable")	$\overline{EN} = 5V$, $V_{OUT} = 0$		100	150	μA	
V_{UVLO}	Under-Voltage Lockout Threshold	Rising edge	2.5	2.7	2.9	V	
V_{UVLO_HYS}	Under-Voltage Lockout Hysteresis			0.1		V	
TDGL	Deglitch Time, Input Power Detected Status	Time measured from V_{IN} 0V to 5V; $1\mu s$ rise time to Output Turn ON		8		ms	
Input OVP – Adjustable (AAT4685-1) (Measured at OVP pin)							
V_{OVP_TH}	Over-Voltage Lockout Threshold	Rising Edge	0.97	1.0	1.03	V	
V_{OVP_HYS}	Over-Voltage Lockout Threshold Hysteresis			20		mV	
V_{OVP_RANGE}	Over-Voltage Lockout Threshold Adjustable Range		4		7	V	
T_{RESP_OV}	Over-Voltage Response Time	V_{OVP} rise to 1.13V from 1.07V in 1ns			1.0	μs	
T_{OVP_REC}	Recovery Time From Input Over-Voltage Release	V_{OVP} fall to 1.07V from 1.13V in 1ns		8		ms	
Input OVP – Fixed (AAT4685-2 and AAT4685-3) (Measured at IN pin)							
V_{OVPT}	Overvoltage Protection Trip Voltage	AAT4685-2	Rising Edge	6.60	6.80	7.0	V
		AAT4685-3		5.71	5.85	6.0	V
V_{OVP_HYS}	Over-Voltage Protection Trip Point Hysteresis			60		mV	
T_{RESP_OV}	Over-Voltage Response Time	V_{IN} rise to 7.5V from 5V			1.0	μs	
T_{OVP_REC}	Recovery Time From Input Over-Voltage Release	V_{IN} fall to 5V from 7.5V		8		ms	
Input OCP							
I_{OCP}	Over-Current Range (Programmable)		0.3		1.8	A	
$\Delta I_{OCP}/I_{OCP}$	Over-Current Trip Tolerance	Rising Edge. $R_{OCP} = 30k\Omega$	0.9	1.0	1.1	A	
T_{OCP_BL}	Blanking Time, Input Over-Current Detected			180		μs	
T_{OCP_REC}	Recovery Time From Input Over-Current Condition			64		ms	
Battery OVP (Measured at BOVP pin)							
V_{BOVPT}	Battery Over-Voltage Protection Trip Voltage	Rising Edge	4.2	4.35	4.5	V	
V_{BOVP_HYS}	Battery Over-Voltage Protection Trip Point Hysteresis			275		mV	
I_{BOVP}	Battery OVP Pin Input Current				100	nA	
T_{BOVP_BL}	Battery OVP Pin Blanking Time			180		μs	

1. The AAT4685 is guaranteed to meet performance specification over the -40 to 85°C operating temperature range and are assured by design, characterization and correlation with statistical process controls.

Over-Voltage Protection Switch with OCP and BOVP

Electrical Characteristics¹

$V_{IN} = 5V$, $V_{BOVP} = 4.2V$, $V_{EN} = 0V$, $R_{OCP} = 30k\Omega$, $T_A = -40^{\circ}C$ to $85^{\circ}C$ unless otherwise noted. Typical values are at $T_A = 25^{\circ}C$.

Symbol	Description	Conditions	Min	Typ	Max	Units
OVP Switch						
$R_{DS(ON)}$	On-Resistance	$R_{OCP} = 16.5k\Omega$, $I_{OUT} = 1200mA$		120	200	m Ω
$I_{D(OFF)}$	Switch Off-Leakage	$\overline{EN} = 5V$			1	μA
Logic Control and Protection						
$V_{\overline{EN}(L)}$	\overline{EN} Input Low Voltage				0.4	V
$V_{\overline{EN}(H)}$	\overline{EN} Input High Voltage		1.2			V
$I_{\overline{EN}(H)}$	\overline{EN} Input Current	$V_{EN} = 5.0V$, Internal Pulldown = 200k		25		μA
$V_{\overline{FLT}}$	\overline{FLT} Output Low Voltage	$I_{\overline{FLT}} = 4mA$			0.4	V
$I_{\overline{FLT}}$	\overline{FLT} Output Leakage	$V_{IN} = 0V$, $\overline{FLT} = 5.5V$			1	μA
$V_{\overline{POK}}$	\overline{POK} Output Low Voltage	$I_{\overline{POK}} = 4mA$			0.4	V
$I_{\overline{POK}}$	\overline{POK} Output Leakage	$V_{IN} = 0V$, $\overline{POK} = 5.5V$			1	μA
T_{ON}	OVP Switch Turn On Delay Time	\overline{EN} from 0V to 5V; $R_{OUT} = 10\Omega$; $C_{OUT} = 1\mu F$		8		ms
T_{SHDN}	Chip Thermal Shutdown Temperature	Threshold		140		$^{\circ}C$
		Hysteresis		15		

1. The AAT4685 is guaranteed to meet performance specification over the -40 to 85°C operating temperature range and are assured by design, characterization and correlation with statistical process controls.

AAT4685

Over-Voltage Protection Switch with OCP and BOVP

Typical Characteristics

Operation Quiescent Current vs. Temperature

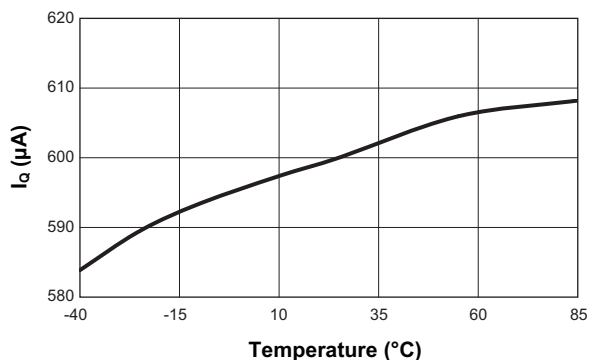

Standby Current vs. Temperature

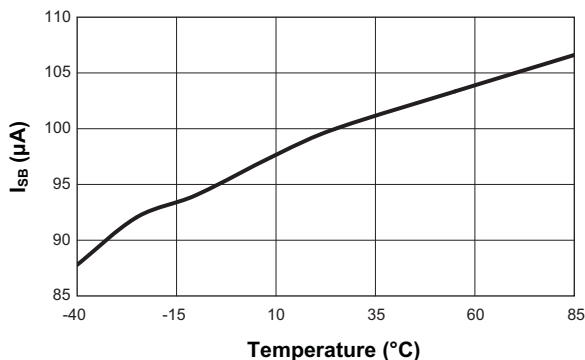

Operation Quiescent and Standby Current vs. Supply Voltage

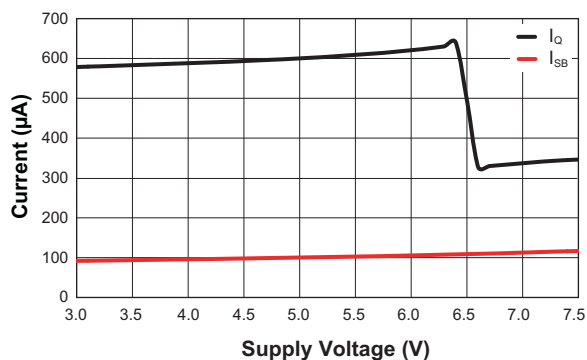

Under-Voltage Lockout Threshold vs. Temperature

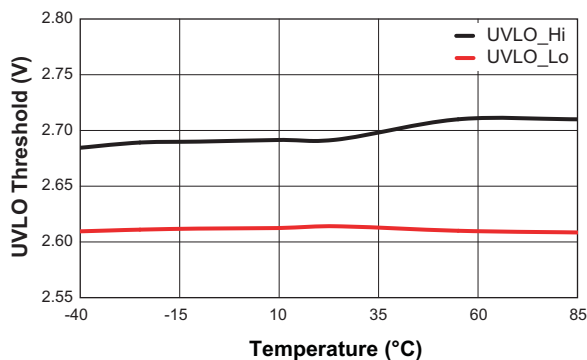

AAT4685-1 Input OVP Threshold vs. Temperature

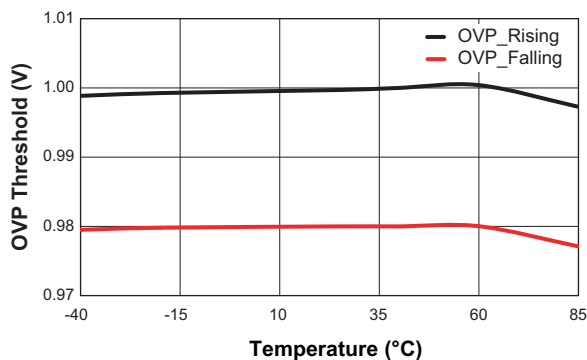

Battery Over-Voltage Protection Trip Voltage vs. Temperature (V_{IN} = 5.0V)

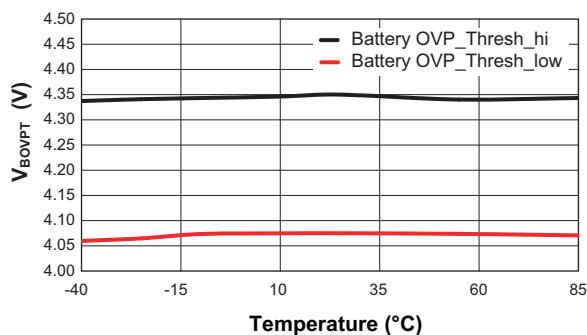

AAT4685

Over-Voltage Protection Switch with OCP and BOVP

Typical Characteristics

\overline{EN} V_{IH} and V_{IL} vs. Supply Voltage

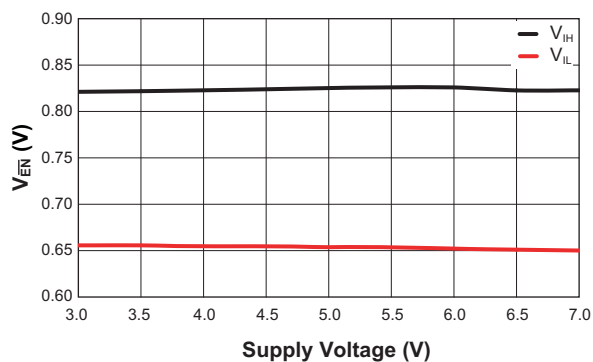

\overline{EN} Pin vs. Temperature ($V_{IN} = 5.0V$)

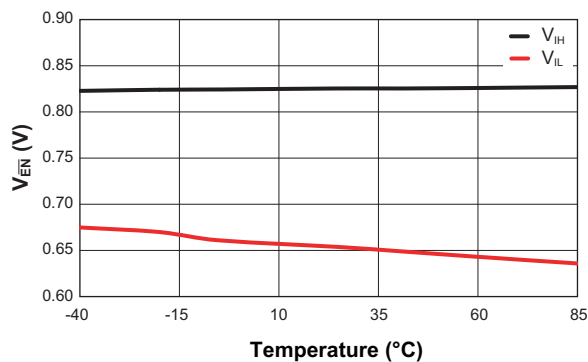

Over-Current Limit vs. R_{OCP}

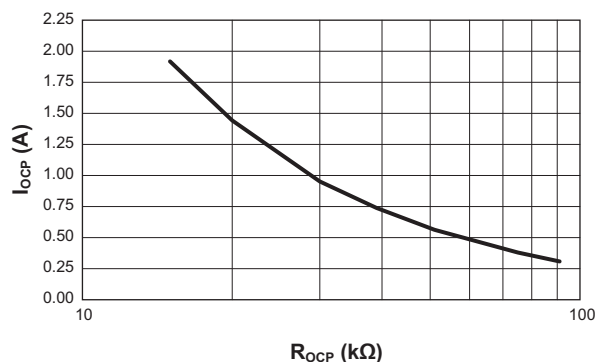

NMOS On-Resistance vs. Temperature

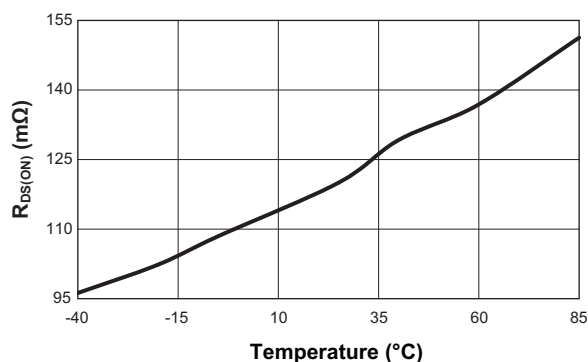

Normal Power-On Startup ($R_{OUT} = 6.3\Omega$)

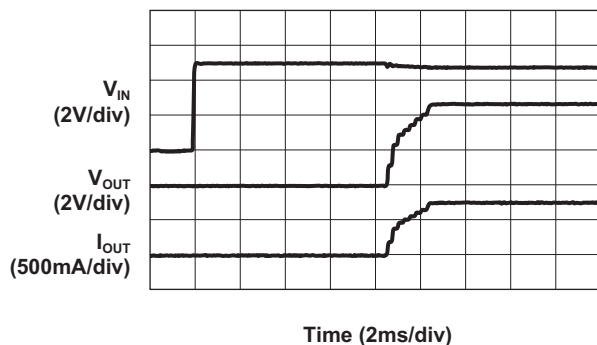

Over-Current Protection (I_{OUT} switches from 0.8A to 1.5A, $I_{LIM} = 1A$)

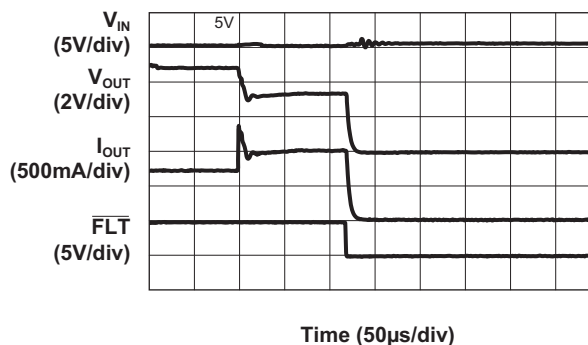

AAT4685

Over-Voltage Protection Switch with OCP and BOVP

Typical Characteristics

Over-Voltage Protection Response for Input Step
($V_{IN} = 5V$ to $12V$)

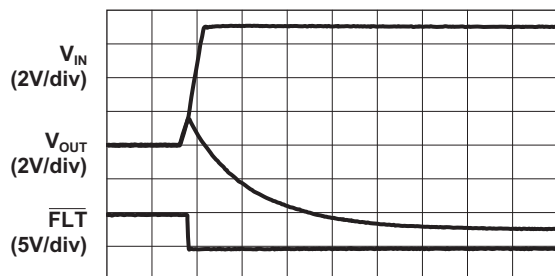

Time (20 μ s/div)

Recovery from Over-Voltage Protection
($V_{IN} = 7V$ to $5V$)



Time (2ms/div)

Battery Over-Voltage Protection
(V_{BOVP} steps from $3.8V$ to $4.5V$)

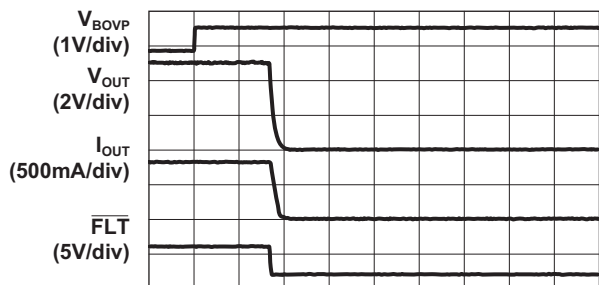

Time (100 μ s/div)

Recovery from Battery Over-Voltage Protection
($V_{BOVP} = 4.5V$ to $3.8V$)

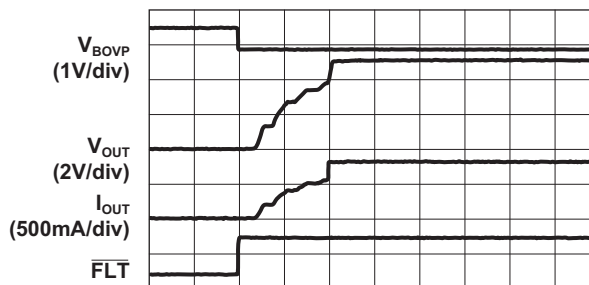

Time (500 μ s/div)

Battery Over-Voltage Protection
(V_{BOVP} Cycles Between $4V$ and $4.5V$)

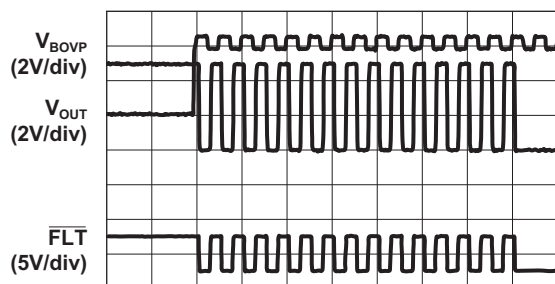

Time (20ms/div)

Power-up into Short Circuit on the OUT Pin

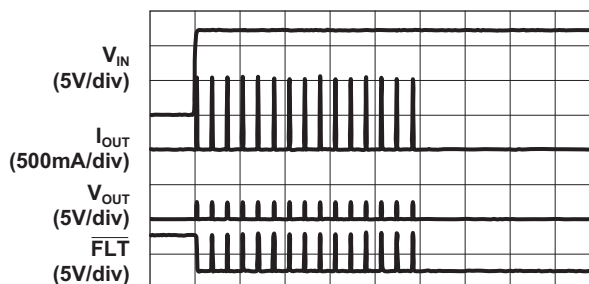

Time (200ms/div)

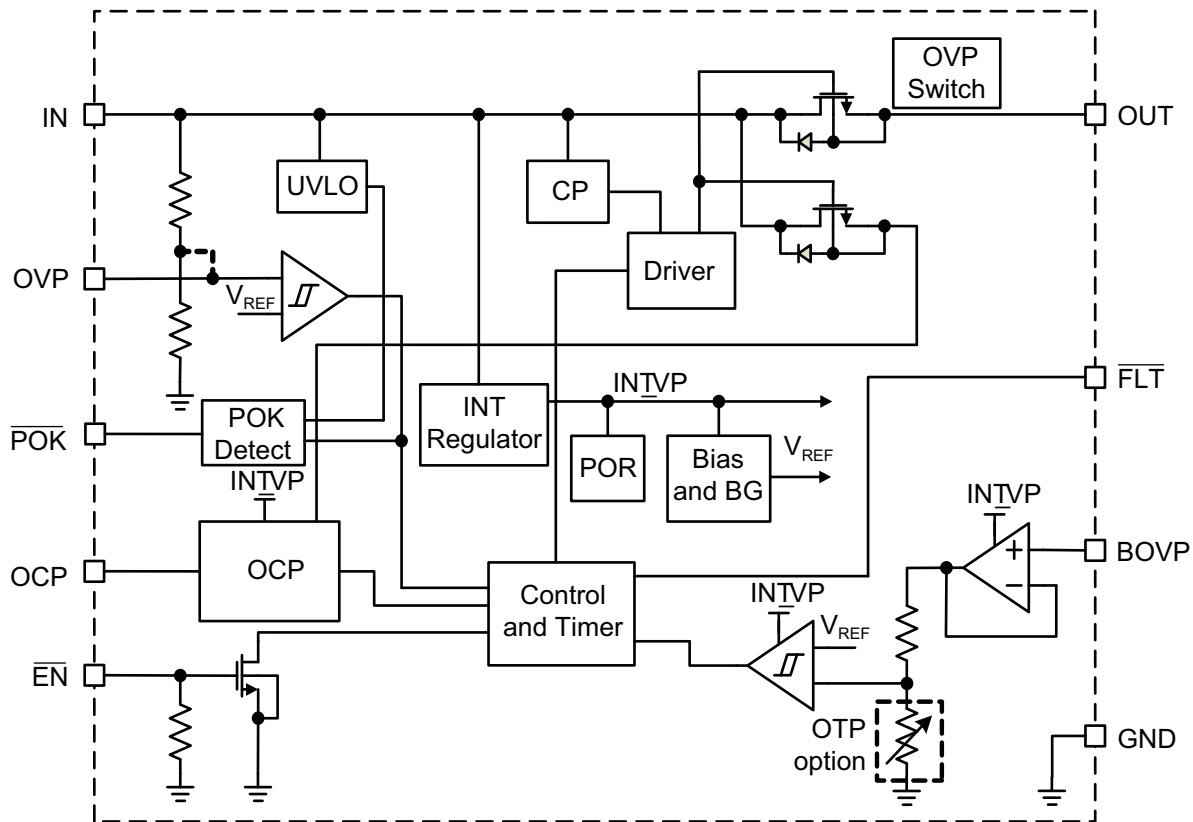
Over-Voltage Protection Switch with OCP and BOVP**Functional Block Diagram****Functional Description**

The AAT4685 provides up to 28V over-voltage and over-current protection when powering low-voltage systems such as cell phones, MP3, and PDAs or when charging Lithium Ion batteries from a badly regulated supply. The AAT4685 is inserted between the power supply or charger source and the load to be protected. The AAT4685 IC consists of a low resistance OVP switch, under-voltage lockout protection, over-voltage monitor and protection, over-current protection, battery over-voltage protection, fast shut-down circuitry and a fault output flag.

In normal operation the OVP switch acts as a slew-rate controlled load switch, connecting and disconnecting the power supply from IN to OUT. A low resistance N channel MOSFET is used as to minimize the voltage drop between the voltage source and the load and to reduce the power dissipation.

When the voltage on the input exceeds the programmed over-voltage trip point, the device immediately turns off

the internal OVP switch disconnecting the load from the abnormal voltage, preventing damage to any downstream components. In the case of an over current condition, it limits the system current at the threshold value, and if the over current persists, the OVP switch is turned off after a blanking period. If the battery voltage rises to an unsafe level (BOVP threshold), the IC disconnects OUT from the charging input power IN until the battery voltage returns to an acceptable value. BOVP or OCP blanking time ignores short time transients of over-battery voltage and overload current. Additionally, AAT4685 also monitors its own die temperature and turns the OVP switch off if it becomes too hot.

The AAT4685 has a fault flag ($\overline{\text{FLT}}$) pin to indicate the fault conditions of input power over-voltage, load current over-current, battery over-voltage, and over-temperature by pulling the flag signal down to alert the system. If an input over-voltage condition or over-voltage battery condition exists at the time of the device enable, then the OVP switch will remain OFF and $\overline{\text{FLT}}$ is always low.

Over-Voltage Protection Switch with OCP and BOVP**Under-Voltage Lockout (UVLO)**

The AAT4685 has a fixed 2.7V under-voltage lockout level (UVLO) trip level for IN rising. When the input voltage is less than $2.7V - V_{UVLO_HYS}$, the OVP switch is turned off. 100mV of hysteresis is included to ensure circuit stability.

Over-Voltage Protection (OVP)

The AAT4685 adjustable version has a $1.0V \pm 3\%$ over-voltage trip threshold on the OVP pin. With a resistor divider on OVP pin from IN to GND, the over-voltage protection point of IN can be adjusted between 4V and 7V. If the over-voltage trip level is triggered, the OVP switch will start to be turned off in 1 μ s. The \overline{FLT} pin is driven low. When the input voltage pin returns below $V_{OVPT} - V_{OVP_HYS}$ (but is still above V_{UVLO}), the OVP switch is turned on again after a T_{OVP_REC} recovery time to ensure that the input supply has stabilized.

Fixed OVP products are also available where the resistive divider is internally integrated. Pin 12 is designed to be not connected.

Over-Current Protection (OCP)

The AAT4685 integrates adjustable over-current protection. Once the load current exceeds the pre-set limit of I_{OCP} current ($I_{LOAD} > I_{OCP}$), the load current is limited after the OCP blanking time (typical 180 μ s). During the OCP blanking time, the OVP switch stays ON. Once the load current drops below I_{OCP} , current restriction will be removed. If the over-current state continues after the blanking period, the OVP switch turns off and \overline{FLT} is pulled down. In order to prevent the input voltage from spiking up due to the inductance of the input cable, the OVP switch is turned off slowly, resulting in a "soft-stop." The OVP switch will turn back on again after T_{OCP_REC} (typical 64ms) and the current is monitored all over again. Each time an OCP fault occurs, an internal counter is incremented. If 15 OCP faults occur in one charge cycle, the OVP switch is turned off permanently. The counter is cleared either by removing and re-applying input power, or by disabling and re-enabling the device via the \overline{EN} pin.

The OCP threshold is set by an external resistor (R_{OCP}) connected between OCP and ground. I_{OCP} is approximated by the following formula:

$$I_{OCP} = \frac{30}{R_{OCP}} \quad (\text{current in A, resistance in k}\Omega)$$

Battery Over-Voltage Protection (BOVP)

The AAT4685 monitors the positive battery terminal and turns the OVP switch off when the battery voltage exceeds the BOVP threshold (typical 4.35V). The monitor has blanking time T_{BOVP_BL} (typical 180 μ s) to prevent any transient voltage from false triggering the BOVP. A resistor is required between the BOVP pin and the battery, to limit the current in case of a short circuit condition. If the battery voltage exceeds the BOVP trip threshold V_{BOVPT} , the OVP switch is turned off, and the \overline{FLT} pin is driven low. In order to prevent the input voltage from spiking up due to the inductance of the input cable, the OVP switch is turned off slowly, resulting in a "soft-stop." The OVP switch is turned back on once the battery voltage drops to $V_{BOVPT} - V_{BOVP_HYS}$. Each time a battery over-voltage fault occurs, an internal counter is incremented. If 15 such faults occur in one charge cycle, the OVP switch is turned off permanently. The counter is cleared either by removing and re-applying input power, or by disabling and re-enabling the device via the \overline{EN} pin.

Over-Temperature Protection (OT Protection)

If the junction temperature of the device exceeds T_{SHDN} , the OVP switch is turned off, and the \overline{FLT} pin is driven low. The OVP switch is turned back on when the junction temperature falls below $T_{SHDN} - 15^{\circ}\text{C}$.

Fault Indicator (\overline{FLT})

The \overline{FLT} output is an active-low open-drain fault (OV/OC/BOVP/OT) reporting output. A pull-up resistor should be connected from \overline{FLT} to the logic I/O voltage of the host system. When \overline{EN} is low, \overline{FLT} is asserted by pulling down in the case of an over-voltage, over-current, or battery over-voltage or over-temperature fault occurring; \overline{FLT} is de-asserted into high impedance state with the fault removed. When \overline{EN} is high, \overline{FLT} is in high impedance status.

Over-Voltage Protection Switch with OCP and BOVP**Enable Control ($\overline{\text{EN}}$)**

$\overline{\text{EN}}$ is an active low enable with internal 200k Ω resistor pulled down to GND. $\overline{\text{EN}}$ is driven low, connected to ground, or left floating for normal device operation. Set $\overline{\text{EN}}$ low to turn the OVP switch on after turn on delay time. Set $\overline{\text{EN}}$ high to turn the OVP switch off. In the case of an over-voltage or UVLO condition toggling $\overline{\text{EN}}$ will not override the fault condition and the OVP switch will remain off. The OCP counter and the BOVP counter are both reset when the device is re-enabled by the $\overline{\text{EN}}$ pin.

IC Input

Internally connected to GND through a 100k Ω resistor. Connect this pin to ground.

Power-OK Indicator ($\overline{\text{POK}}$)

The AAT4685 contains an open-drain $\overline{\text{POK}}$ output that goes low when a valid input source is detected at the IN pin. The valid input range is between V_{UVLO} (typical 2.7V) and V_{OVP} voltage (fixed 5.85V / fixed 6.8V / adjustable OVP threshold set by external resistors). After a valid input has been established, charging is sustained. The $\overline{\text{POK}}$ function is always active whether the $\overline{\text{EN}}$ pin is at low or high state.

Device Start-Up Operation

On initial power-up, if $V_{\text{UVLO}} < \text{IN} < V_{\text{OVP}}$, $V_{\text{BAT}} < V_{\text{BOVP}}$, and $\overline{\text{EN}}$ is low, the OVP switch starts to turn on after T_{ON} delay time (typical 8ms) to be stabilized for input. This turn on uses Soft Start to control the inrush current to minimize ringing at the input. Because of the deglitch time at power on, if the input voltage rises rapidly past the OVP threshold, the device does not switch on at all; instead it goes into protection mode and indicate a fault on the $\overline{\text{FLT}}$ pin. After successful start-up, if $I_{\text{LOAD}} > I_{\text{OCP}}$ limit the device turns off and the fault flag is asserted.

The Soft Start function is defined as follows: "current limit is stepped digitally from low level to its final current limit level for soft starting."

Over-Voltage Protection Switch with OCP and BOVP

System Flowchart

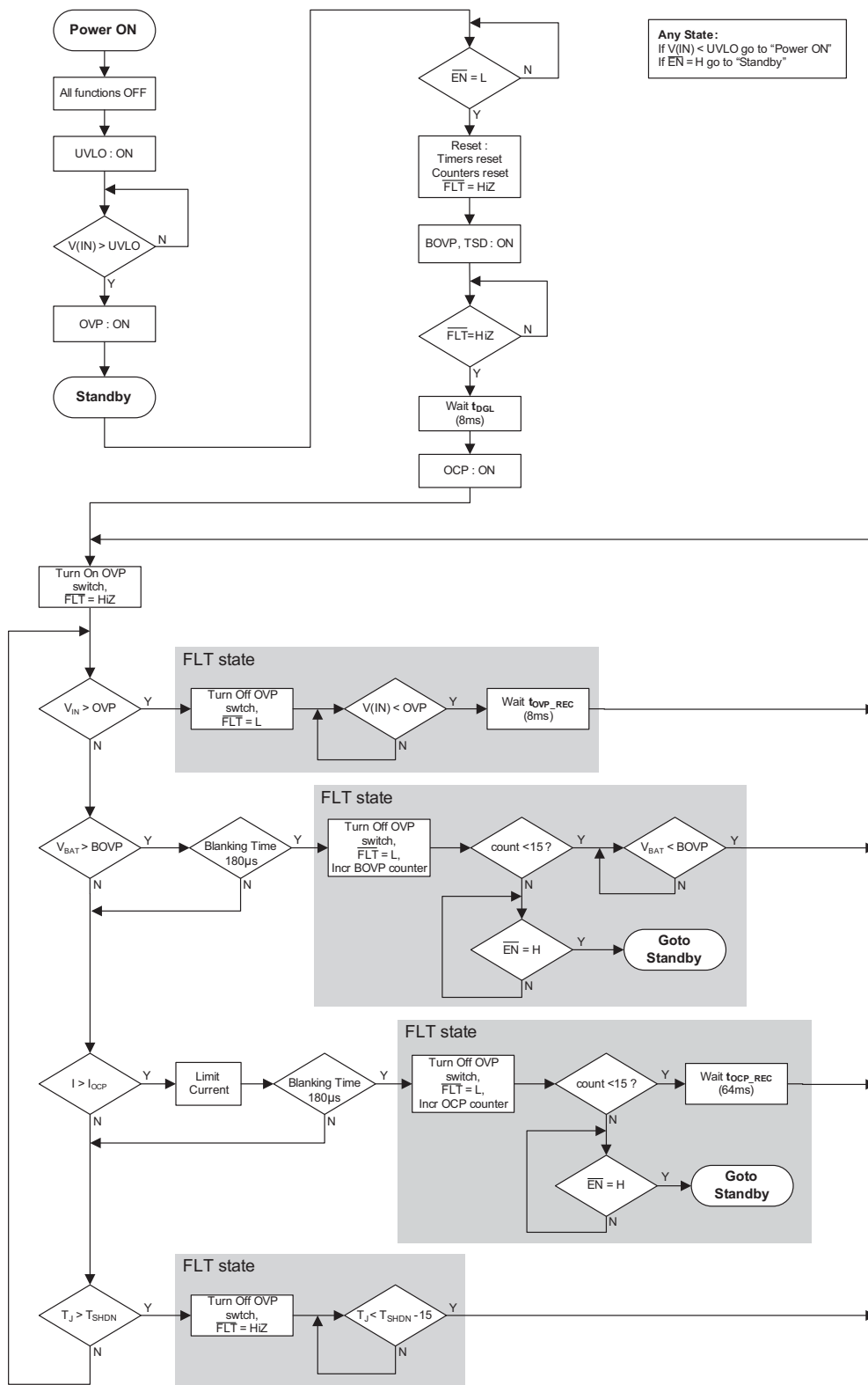

Over-Voltage Protection Switch with OCP and BOVP

Application Information

Over-Voltage Protection Resistors

The over-voltage protection threshold is programmed with two resistors, R1 and R2. To limit the current going through the external resistor string while maintaining good noise immunity, use smaller resistor values, such as 10kΩ for R2. Using a larger value will further reduce the system current, but will also increase the impedance of the OVP node, making it more sensitive to external noise and interference. A suggested value for R2 is 100kΩ. R1 can be calculated using the following equation:

$$R_1 = \left(\frac{V_{OVP}}{V_{OVP_TH}} - 1 \right) \cdot R_2 = (V_{OVP} - 1) \cdot 100$$

Table 1 summarizes 1% standard metal film resistors for several over-voltage settings.

R2 (kΩ)	R1 (kΩ)	V _{OVP} Setting (V)
100	300	4.0
100	348	4.5
100	402	5.0
100	442	5.5
100	499	6.0
100	549	6.5
100	604	7.0

Table 1: 1% Standard Resistor Values for OVP Setting.

Over-Current Protection Resistor

The over-current threshold is programmed by an external resistor (R_{OCP}) connected from the OCP pin to GND. R_{OCP} can be calculated by the following equation.

$$R_{OCP} = \frac{30}{I_{OCP}} \cdot 1000$$

Table 2 summarizes 1% standard metal film resistors for several over-current settings.

R3 (kΩ)	I _{OCP} Setting (A)
100.0	0.30
86.6	0.35
75.0	0.40
66.5	0.45
60.4	0.50
54.9	0.55
49.9	0.60
43.0	0.70
37.4	0.80
33.2	0.90
30.1	1.00
24.9	1.20
21.5	1.40
18.7	1.60
16.5	1.80

Table 2: 1% Standard Resistor Values for OCP Setting.

Input Capacitor

A 1μF or larger capacitor is typically recommended for C_{IN}. C_{IN} should be located as close to the device IN pin as practically possible. Ceramic, tantalum, or aluminum electrolytic capacitors may be selected for C_{IN}. There is no specific capacitor equivalent series resistance (ESR) requirement for C_{IN}. However, for higher current operation, ceramic capacitors are recommended for C_{IN} due to their inherent capability over tantalum capacitors to withstand input current surges from low impedance sources such as batteries in portable devices.

Capacitors are typically manufactured in different voltage ratings. If the maximum possible surge voltage is known, select capacitors with a voltage rating at least 5V higher than the maximum possible surge voltage. 50V rated capacitors are generally good for most OVP applications to prevent any surge voltage.

Over-Voltage Protection Switch with OCP and BOVP

Output Capacitor

In order to insure stability while current limit is active, a small output capacitance of approximately $1\mu\text{F}$ is required at the output. Likewise, with the output capacitor, there is no specific capacitor ESR requirement. If desired, C_{OUT} may be increased to accommodate any load transient condition.

PCB Layout Recommendations

For proper thermal management and to take advantage of the low $R_{\text{DS(ON)}}$ of the AAT4685, certain circuit board layout rules should be followed:

1. V_{IN} and V_{OUT} should be routed using wider than normal traces.
2. GND should be connected to a ground plane. The ground plane area connected to the ground pins should be made as large as possible. Exposed pad should be connected to ground plane to get best power dissipation.
3. For best performance, C_{IN} and C_{OUT} should be placed close to the IN and OUT pins.

Evaluation Board Schematic

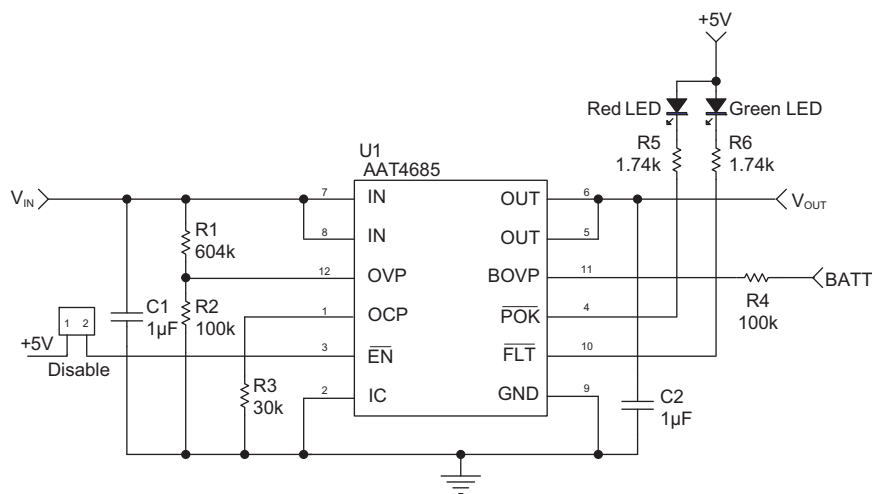

Figure 1: AAT4685 Evaluation Board Schematic.

Over-Voltage Protection Switch with OCP and BOVP

Evaluation Board Layout

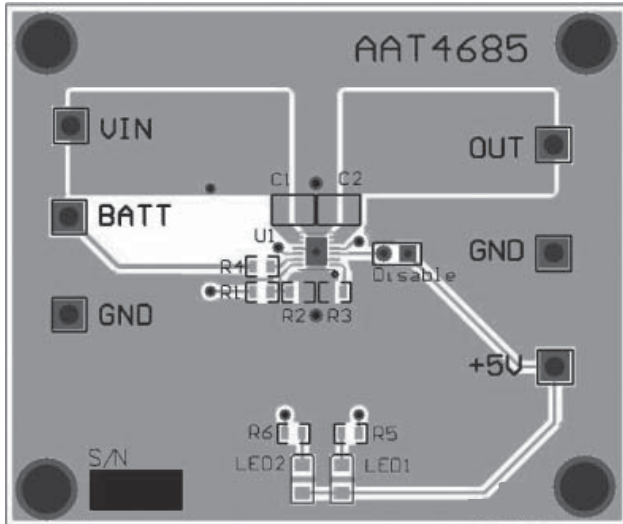

Figure 2: AAT4685 Evaluation Board Top Side Layout.

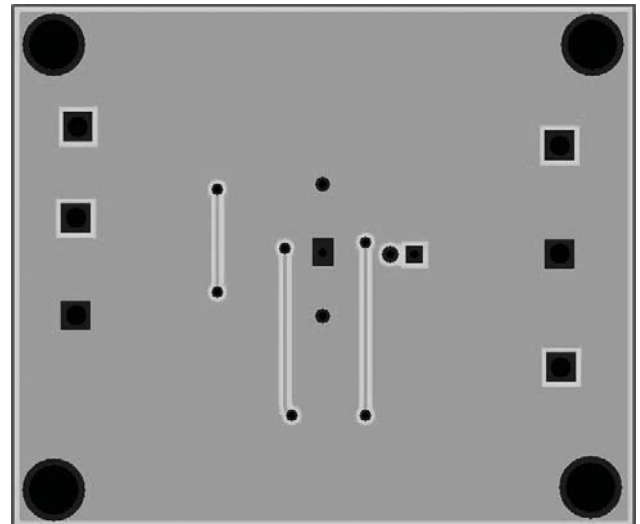

Figure 3: AAT4685 Evaluation Board Bottom Side Layout.

Evaluation Board Bill of Materials

Designator	Part Number	Description	Manufacturer
U1	AAT4685IWP-1-T1	IC Over-Voltage Protection Switch with OCP	Skyworks
C1, C2	GRM21BR71H105K	Cap Ceramic 1μF 0805 X7R 50V 10%	Murata
R1	RC0603FR-07604KL	Res 604kΩ 1/10W 1% 0603 SMD	Yageo
R3	RC0603FR-0730K1L	Res 30.1KΩ 1/10W 1% 0603 SMD	
R2, R4	RC0603FR-07100KL	Res 100KΩ 1/10W 1% 0603 SMD	
R5, R6	RC0603FR-071K74RL	Res 1.74kΩ 1/10W 1% 0603 SMD	
LED1	0805KRCT	LED Red 0805	HB
LED2	0805KGCT	LED Green 0805	

Table 3: AAT4685 Evaluation Board Bill of Materials (BOM).

AAT4685

Over-Voltage Protection Switch with OCP and BOVP

Ordering Information

Package	OVP Trip Voltage	Marking ¹	Part Number (Tape and Reel) ²
TDFN33-12	Adjustable	8LXYY	AAT4685IWP-1-T1
TDFN33-12	6.80V		AAT4685IWP-2-T1
TDFN33-12	5.85V		AAT4685IWP-3-T1



Skyworks Green™ products are compliant with all applicable legislation and are halogen-free.

For additional information, refer to Skyworks

Definition of Green™, document number

SQ04-0074.

Packaging Information

TDFN33-12

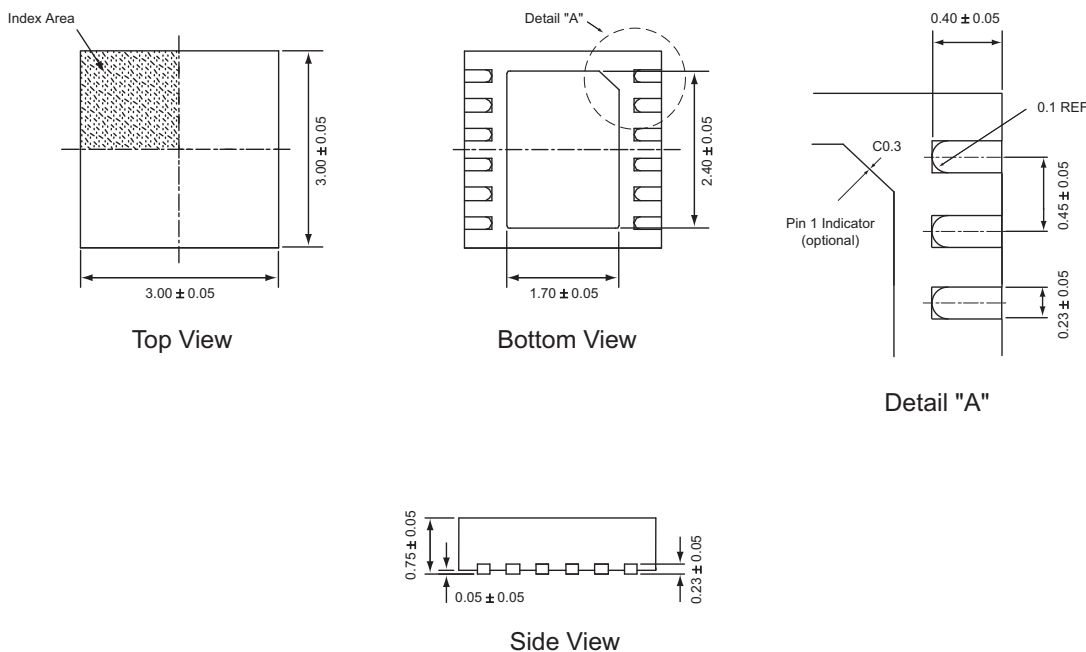

All dimensions in millimeters.

1. XYY = assembly and date code.
2. Sample stock is generally held on part numbers listed in **BOLD**.
3. The leadless package family, which includes QFN, TQFN, DFN, TDFN and STDFN, has exposed copper (unplated) at the end of the lead terminals due to the manufacturing process. A solder fillet at the exposed copper edge cannot be guaranteed and is not required to ensure a proper bottom solder connection.

Over-Voltage Protection Switch with OCP and BOVP

Copyright © 2012 Skyworks Solutions, Inc. All Rights Reserved.

Information in this document is provided in connection with Skyworks Solutions, Inc. ("Skyworks") products or services. These materials, including the information contained herein, are provided by Skyworks as a service to its customers and may be used for informational purposes only by the customer. Skyworks assumes no responsibility for errors or omissions in these materials or the information contained herein. Skyworks may change its documentation, products, services, specifications or product descriptions at any time, without notice. Skyworks makes no commitment to update the materials or information and shall have no responsibility whatsoever for conflicts, incompatibilities, or other difficulties arising from any future changes.

No license, whether express, implied, by estoppel or otherwise, is granted to any intellectual property rights by this document. Skyworks assumes no liability for any materials, products or information provided hereunder, including the sale, distribution, reproduction or use of Skyworks products, information or materials, except as may be provided in Skyworks Terms and Conditions of Sale.

THE MATERIALS, PRODUCTS AND INFORMATION ARE PROVIDED "AS IS" WITHOUT WARRANTY OF ANY KIND, WHETHER EXPRESS, IMPLIED, STATUTORY, OR OTHERWISE, INCLUDING FITNESS FOR A PARTICULAR PURPOSE OR USE, MERCHANTABILITY, PERFORMANCE, QUALITY OR NON-INFRINGEMENT OF ANY INTELLECTUAL PROPERTY RIGHT; ALL SUCH WARRANTIES ARE HEREBY EXPRESSLY DISCLAIMED. SKYWORKS DOES NOT WARRANT THE ACCURACY OR COMPLETENESS OF THE INFORMATION, TEXT, GRAPHICS OR OTHER ITEMS CONTAINED WITHIN THESE MATERIALS. SKYWORKS SHALL NOT BE LIABLE FOR ANY DAMAGES, INCLUDING BUT NOT LIMITED TO ANY SPECIAL, INDIRECT, INCIDENTAL, STATUTORY, OR CONSEQUENTIAL DAMAGES, INCLUDING WITHOUT LIMITATION, LOST REVENUES OR LOST PROFITS THAT MAY RESULT FROM THE USE OF THE MATERIALS OR INFORMATION, WHETHER OR NOT THE RECIPIENT OF MATERIALS HAS BEEN ADVISED OF THE POSSIBILITY OF SUCH DAMAGE.



Skyworks products are not intended for use in medical, lifesaving or life-sustaining applications, or other equipment in which the failure of the Skyworks products could lead to personal injury, death, physical or environmental damage. Skyworks customers using or selling Skyworks products for use in such applications do so at their own risk and agree to fully indemnify Skyworks for any damages resulting from such improper use or sale.

Customers are responsible for their products and applications using Skyworks products, which may deviate from published specifications as a result of design defects, errors, or operation of products outside of published parameters or design specifications. Customers should include design and operating safeguards to minimize these and other risks. Skyworks assumes no liability for applications assistance, customer product design, or damage to any equipment resulting from the use of Skyworks products outside of stated published specifications or parameters.

Skyworks, the Skyworks symbol, and "Breakthrough Simplicity" are trademarks or registered trademarks of Skyworks Solutions, Inc., in the United States and other countries. Third-party brands and names are for identification purposes only, and are the property of their respective owners. Additional information, including relevant terms and conditions, posted at www.skyworksinc.com, are incorporated by reference.

Looking for pricing, stock, or lifecycle information?

Click below to explore more details on WIN SOURCE:

-  [View AAT4685IWP-1-T1 on WIN SOURCE](#)
-  [Skyworks Solutions Inc. Information](#)

Optimize Your Supply Chain with WIN SOURCE Solutions

-  Global Sourcing Solution
-  Obsolete Management
-  Cost Control Management
-  Shortage Management
-  Alternative Solution
-  Excess Inventory Management