



**THE DATASHEET OF
AAT4280IGU-1-T1**



General Description

The AAT4280 SmartSwitch is a P-channel MOSFET power switch designed for high-side load switching applications. The P-channel MOSFET device has a typical $R_{DS(ON)}$ of $80m\Omega$, allowing increased load switch power handling capacity. This device is available in three different versions with flexible turn on and off characteristics from very fast to slew rate limited. The standard AAT4280 (-1) version has a slew rate limited turn on load switch and is functionally compatible with the AAT4250 device while offering superior $R_{DS(ON)}$ characteristics. The AAT4280 (-2) version features fast load switch turn on capabilities, typically less than 500ns turn on and $3\mu s$ turn off times. The AAT4280 (-3) variation offers a shutdown load discharge circuit to rapidly turn off a load circuit when the switch is disabled. All AAT4280 load switch versions operate with an input voltage ranging from 1.8V to 5.5V, making them ideal for both 3V and 5V systems. The AAT4280 also features an under-voltage lockout which turns the switch off when an input under-voltage condition exists. Input logic levels are TTL and 2.5V to 5V CMOS compatible. The quiescent supply current is very low, typically $2.5\mu A$. In shutdown mode, the supply current decreases to less than $1\mu A$.

The AAT4280 is available in a Pb-free, 6-pin SOT23 or 8-pin SC70JW package and is specified over the $-40^{\circ}C$ to $+85^{\circ}C$ temperature range.

Features

- 1.8V to 5.5V Input Voltage Range
- Very Low $R_{DS(ON)}$, Typically $80m\Omega$ (5V)
- Slew Rate Limited Turn-On Time Options
 - 1ms
 - $0.5\mu s$
 - $100\mu s$
- Fast Shutdown Load Discharge Option
- Low Quiescent Current
 - $2.5\mu A$ Typical
 - $1\mu A$ Max in Shutdown
- TTL/CMOS Input Logic Level
- Temperature Range: $-40^{\circ}C$ to $+85^{\circ}C$
- 4kV ESD Rating
- 6-Pin SOT23 or 8-Pin SC70JW Package

Applications

- Cellular Telephones
- Digital Still Cameras
- Hot Swap Supplies
- Notebook Computers
- Personal Communication Devices
- Personal Digital Assistants (PDA)

Typical Application

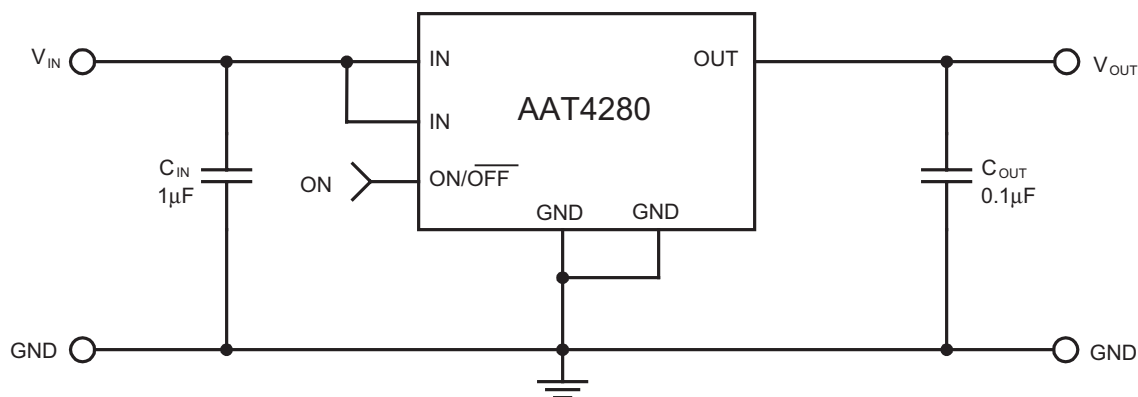

*Slew Rate Controlled Load Switch***Pin Descriptions**

Pin Number		Symbol	Function
SOT23-6	SC70JW-8		
1	2	OUT	This pin is the P-channel MOSFET drain connection. Bypass to ground through a 0.1 μ F capacitor.
2, 5	4	GND	Ground connection.
3	3	ON/OFF	Enable input.
4, 6	1, 5, 6, 7, 8	IN	This pin is the input to the P-channel MOSFET source. Bypass to ground through a 1.0 μ F capacitor.

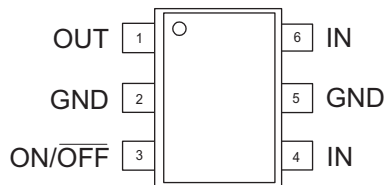
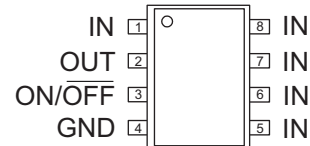
Pin Configuration**SOT23-6
(Top View)****SC70JW-8
(Top View)**

AAT4280

Slew Rate Controlled Load Switch

Selector Guide

Part Number	Slew Rate (typ)	Active Pull Down	Enable
AAT4280-1	1ms		Active High
AAT4280-2	0.5 μ s		Active High
AAT4280-3	100 μ s	✓	Active High

Absolute Maximum Ratings¹

T_A = 25°C, unless otherwise noted.

Symbol	Description	Value	Units
V _{IN}	IN to GND	-0.3 to 6	V
V _{ON}	ON/OFF to GND	-0.3 to 6	V
V _{OUT}	OUT to GND	-0.3 to V _{IN} + 0.3	V
I _{MAX}	Maximum Continuous Switch Current	2.3	A
I _{DM}	Maximum Pulsed Current	IN \geq 2.5V	6
		IN < 2.5V	3
T _J	Operating Junction Temperature Range	-40 to 150	°C
T _S	Storage Temperature Range	-65 to 150	°C
T _{LEAD}	Maximum Soldering Temperature (at leads)	300	°C
V _{ESD}	ESD Rating ² - HBM	4000	V

Thermal Characteristics³

Symbol	Description	Value		Units
		SOT23-6	SC70JW-8	
Θ_{JA}	Thermal Resistance	120	140	°C/W
P _D	Power Dissipation	833	714	mW

1. -Stresses above those listed in Absolute Maximum Ratings may cause permanent damage to the device. Functional operation at conditions other than the operating conditions specified is not implied. Only one Absolute Maximum Rating should be applied at any one time.

2. Human body model is a 100pF capacitor discharged through a 1.5k Ω resistor into each pin.

3. Mounted on an AAT4280 demo board in still 25°C air.

Electrical Characteristics

$V_{IN} = 5V$, $T_A = -40^{\circ}C$ to $+85^{\circ}C$, unless otherwise noted. Typical values are $T_A = 25^{\circ}C$.

Symbol	Description	Conditions	Min	Typ	Max	Units
AAT4280 All Versions						
V_{IN}	Operation Voltage		1.81		5.5	V
V_{UVLO}	Under-Voltage Lockout	V_{IN} Falling	1.0	1.4	1.8	V
$V_{UVLO(hys)}$	Under-Voltage Lockout Hysteresis			250		mV
I_Q	Quiescent Current	ON/ \overline{OFF} = Active		2.5	4	μA
$I_{Q(OFF)}$	Off Supply Current	ON/ \overline{OFF} = Inactive, OUT = Open			1	μA
$I_{SD(OFF)}$	Off Switch Current	ON/ \overline{OFF} = Inactive, $V_{OUT} = 0$			1	μA
$R_{DS(ON)}$	On Resistance	$V_{IN} = 5V$, $T_A = 25^{\circ}C$		80	120	m Ω
		$V_{IN} = 4.2V$, $T_A = 25^{\circ}C$		85	130	
		$V_{IN} = 3V$, $T_A = 25^{\circ}C$		100	150	
		$V_{IN} = 1.8V$, $T_A = 25^{\circ}C$		160	250	
TC_{RDS}	On Resistance Temperature Coefficient			2800		ppm/ $^{\circ}C$
V_{IL}	ON/ \overline{OFF} Input Logic Low Voltage	$V_{IN} = 2.7V$ to $5.5V^2$			0.8	V
		$V_{IN} = 2.7V$ to $\leq 4.2V$	2			
V_{IH}	ON/ \overline{OFF} Input Logic High Voltage	$V_{IN} = 3.3V$	1.8			V
		$V_{IN} = >4.2V$ to $5.5V$	2.4			
I_{SINK}	ON/ \overline{OFF} Input Leakage	$V_{ON/OFF} = 5.5V$			1	μA
AAT4280-1						
$T_{D(ON)}$	Output Turn-On Delay	$V_{IN} = 5V$, $R_{LOAD} = 10\Omega$, $T_A = 25^{\circ}C$		20	40	μs
T_{ON}	Output Turn-On Rise Time	$V_{IN} = 5V$, $R_{LOAD} = 10\Omega$, $T_A = 25^{\circ}C$		1000	1500	μs
$T_{D(OFF)}$	Output Turn-Off Delay Time	$V_{IN} = 5V$, $R_{LOAD} = 10\Omega$, $T_A = 25^{\circ}C$		4	10	μs
AAT4280-2						
$T_{D(ON)}$	Output Turn-On Delay	$V_{IN} = 5V$, $R_{LOAD} = 10\Omega$, $T_A = 25^{\circ}C$		0.5	2	μs
T_{ON}	Output Turn-On Rise Time	$V_{IN} = 5V$, $R_{LOAD} = 10\Omega$, $T_A = 25^{\circ}C$		0.5	1	μs
$T_{D(OFF)}$	Output Turn-Off Delay Time	$V_{IN} = 5V$, $R_{LOAD} = 10\Omega$, $T_A = 25^{\circ}C$		4	10	μs
AAT4280-3						
$T_{D(ON)}$	Output Turn-On Delay	$V_{IN} = 5V$, $R_{LOAD} = 10\Omega$, $T_A = 25^{\circ}C$		20	40	μs
T_{ON}	Output Turn-On Rise Time	$V_{IN} = 5V$, $R_{LOAD} = 10\Omega$, $T_A = 25^{\circ}C$		100	150	μs
$T_{D(OFF)}$	Output Turn-Off Delay Time	$V_{IN} = 5V$, $R_{LOAD} = 10\Omega$, $T_A = 25^{\circ}C$		4	10	μs
R_{PD}	Output Pull-Down Resistance During \overline{OFF}	ON/ \overline{OFF} = Inactive, $T_A = 25^{\circ}C$		150	250	Ω

1. Part requires minimum start-up of $V_{IN} \square 2.0V$ to ensure operation down to 1.8V.

2. For V_{IN} outside this range, consult typical ON/ \overline{OFF} threshold curve.

Typical Characteristics

Unless otherwise noted, $V_{IN} = 5V$, $T_A = 25^\circ C$.

Quiescent Current vs. Temperature

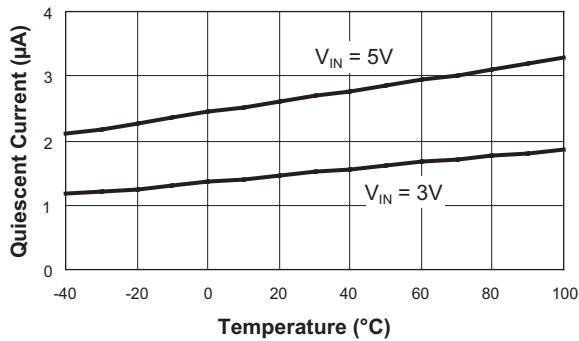

Quiescent Current vs. Input Voltage

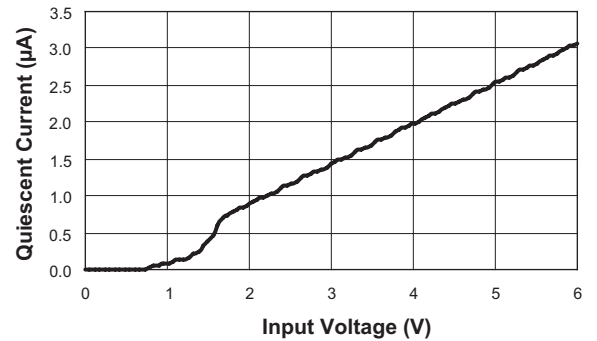

$R_{DS(ON)}$ vs. Input Voltage

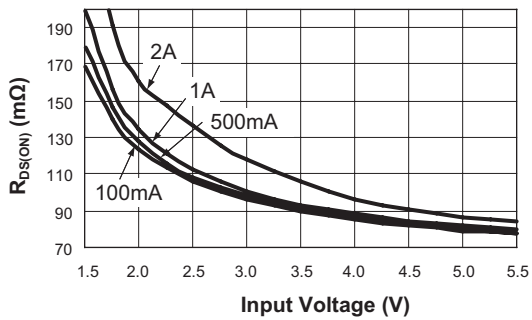

$R_{DS(ON)}$ vs. Temperature

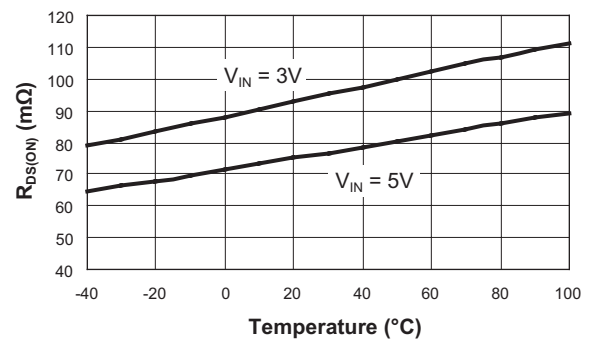

ON/OFF Threshold vs. Input Voltage

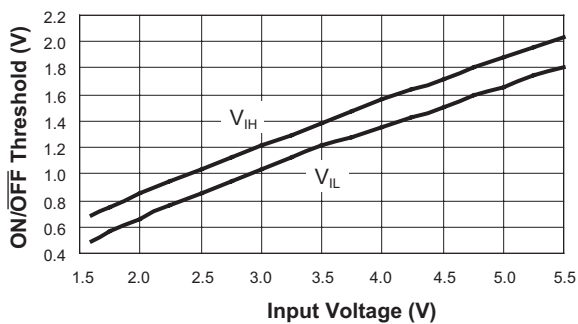

Off-Switch Current vs. Temperature

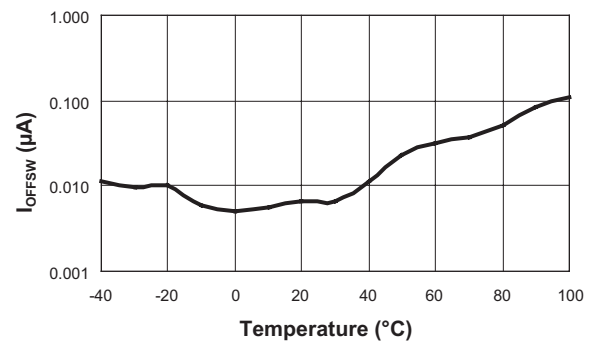

AAT4280

Slew Rate Controlled Load Switch

Typical Characteristics—AAT4280-1

Unless otherwise noted, $V_{IN} = 5V$, $T_A = 25^\circ C$.

AAT4280-1 Turn-On
($V_{IN} = 3V$; $R_L = 6\Omega$)

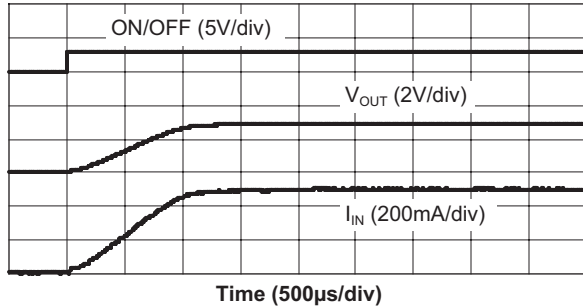

AAT4280-1 Turn-On
($V_{IN} = 5V$; $R_L = 10\Omega$)

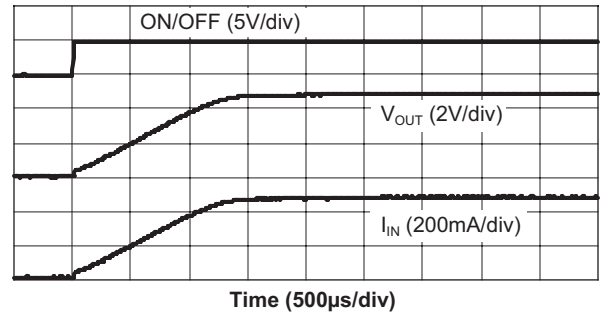

AAT4280-1 Turn-Off
($V_{IN} = 3V$; $R_L = 6\Omega$)

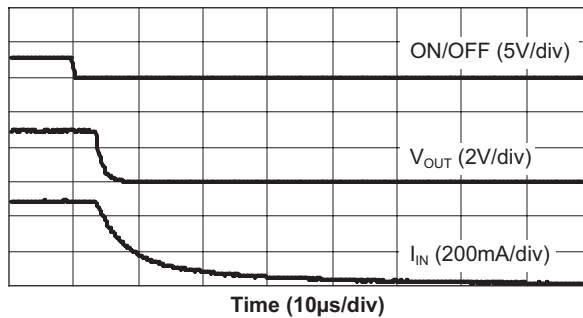

AAT4280-1 Turn-Off
($V_{IN} = 5V$; $R_L = 10\Omega$)

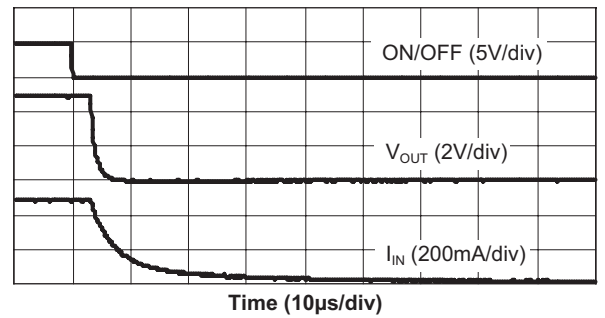

AAT4280

Slew Rate Controlled Load Switch

Typical Characteristics—AAT4280-2

Unless otherwise noted, $V_{IN} = 5V$, $T_A = 25^\circ C$.

AAT4280-2 Turn-On
($V_{IN} = 3V$; $R_L = 6\Omega$)

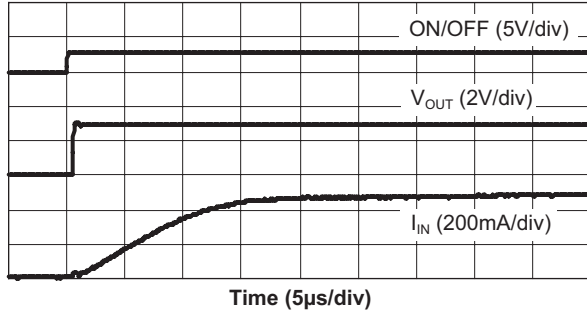

AAT4280-2 Turn-On
($V_{IN} = 5V$; $R_L = 10\Omega$)

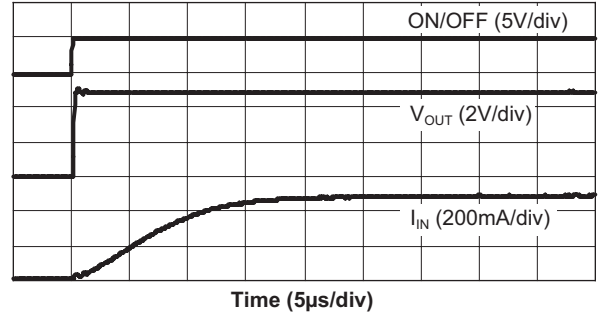

AAT4280-2 Turn-Off
($V_{IN} = 3V$; $R_L = 6\Omega$)

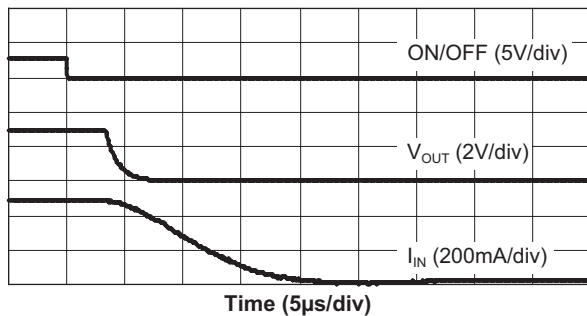

AAT4280-2 Turn-Off
($V_{IN} = 5V$; $R_L = 10\Omega$)

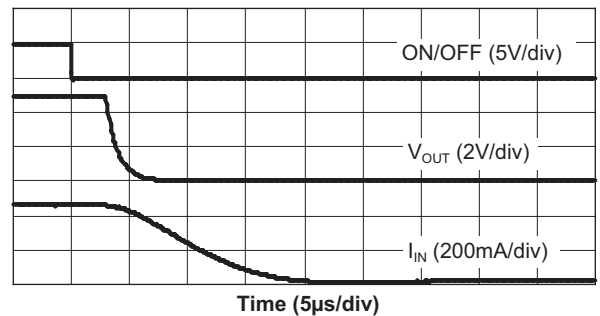

AAT4280

Slew Rate Controlled Load Switch

Typical Characteristics—AAT4280-3

Unless otherwise noted, $V_{IN} = 5V$, $T_A = 25^\circ C$.

AAT4280-3 Turn-On
($V_{IN} = 3V$; $R_L = 6\Omega$)

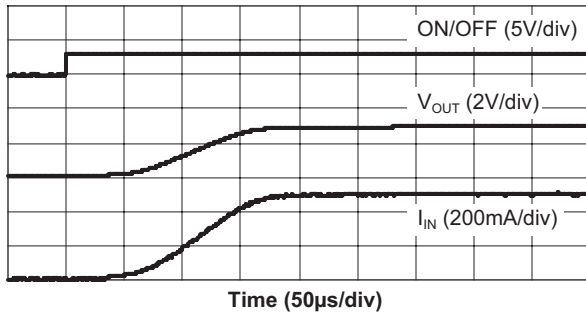

AAT4280-3 Turn-On
($V_{IN} = 5V$; $R_L = 10\Omega$)

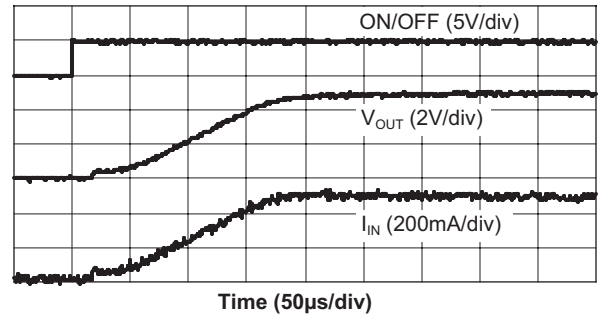

AAT4280-3 Turn-Off
($V_{IN} = 3V$; $R_L = 6\Omega$)

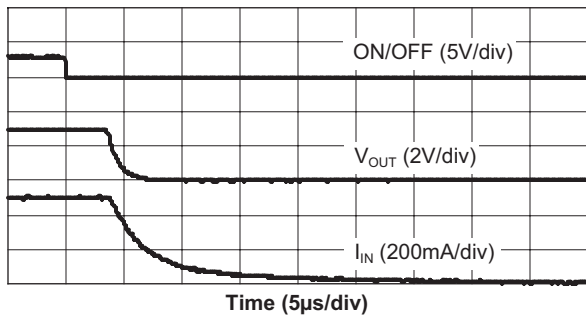

AAT4280-3 Turn-Off
($V_{IN} = 5V$; $R_L = 10\Omega$)

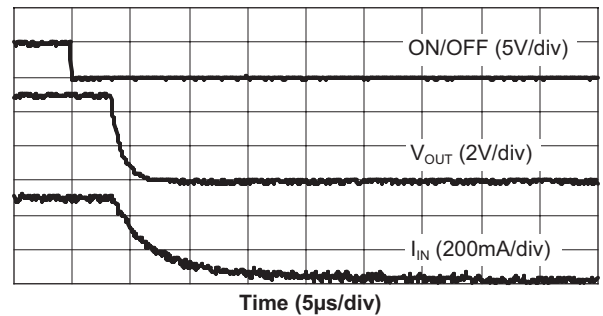

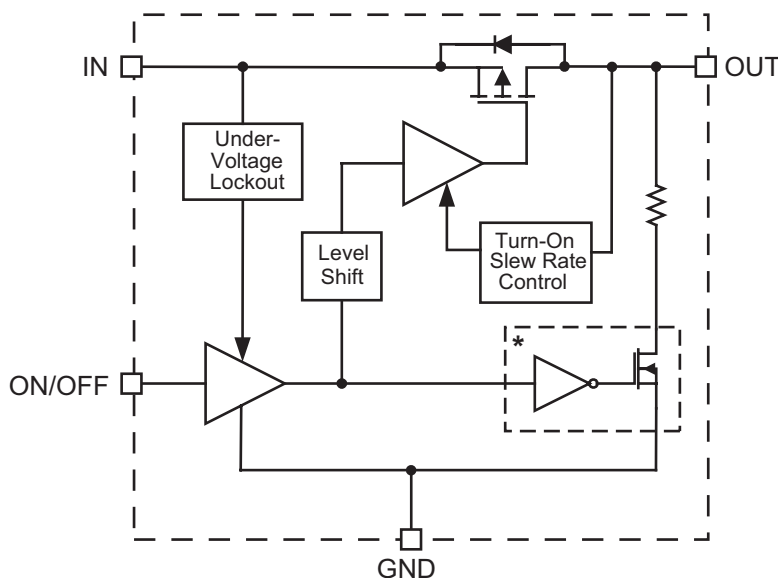
Functional Block Diagram

*AAT4280-3 only

Functional Description

The AAT4280 is a family of flexible P-channel MOSFET power switches designed for high-side load switching applications. There are three versions of the AAT4280 with different turn-on and turn-off characteristics to choose from, depending upon the specific requirements of an application. The first version, the AAT4280-1, has a moderate turn-on slew rate feature, which reduces inrush current when the MOSFET is turned on. This function allows the load switch to be implemented with either a small input capacitor or no input capacitor at all. During turn-on slewing, the current ramps linearly until it reaches the level required for the output load condition. The proprietary turn-on current control method works by careful control and monitoring of the MOSFET gate voltage. When the device is switched ON, the gate voltage is quickly increased to the threshold level of the MOSFET. Once at this level, the current begins to slew as the gate voltage is slowly increased until the MOSFET becomes fully enhanced. Once it has reached this point, the gate is quickly increased to the full input voltage and $R_{DS(ON)}$ is minimized.

The second version, the AAT4280-2, is a very fast switch intended for high-speed switching applications. This version has no turn-on slew rate control and no special output discharge features.

The final version, the AAT4280-3, has the addition of a minimized slew rate limited turn-on function and a shut-down output discharge circuit to rapidly turn off a load when the load switch is disabled through the ON/OFF pin.

All versions of the AAT4280 operate with input voltages ranging from 1.8V to 5.5V. All versions of this device have extremely low operating current, making them ideal for battery-powered applications. In cases where the input voltage drops below 1.8V, the AAT4280 MOSFET device is protected from entering into the saturation region of operation by automatically shutting down through an under-voltage lockout control circuit. The ON/OFF control pin is TTL compatible and will also function with 2.5V to 5V logic systems, making the AAT4280 an ideal level-shifting load switch.

Slew Rate Controlled Load Switch**Applications Information****Input Capacitor**

A 1 μ F or larger capacitor is typically recommended for C_{IN} in most applications. A C_{IN} capacitor is not required for basic operation. However, C_{IN} is useful in preventing load transients from affecting upstream circuits. C_{IN} should be located as close to the device V_{IN} pin as practically possible. Ceramic, tantalum, or aluminum electrolytic capacitors may be selected for C_{IN} . There is no specific capacitor ESR requirement for C_{IN} . However, for higher current operation, ceramic capacitors are recommended for C_{IN} due to their inherent capability over tantalum capacitors to withstand input current surges from low impedance sources, such as batteries in portable devices.

Output Capacitor

For proper slew operation, a 0.1 μ F capacitor or greater between V_{OUT} and GND is recommended. The output capacitor has no specific capacitor type or ESR requirement. If desired, C_{OUT} may be increased without limit to accommodate any load transient condition without adversely affecting the device turn-on slew rate time.

Enable Function

The AAT4280 features an enable / disable function. This pin (ON/OFF) is compatible with both TTL or CMOS logic.

Reverse Output-to-Input Voltage Conditions and Protection

Under normal operating conditions, a parasitic diode exists between the output and input of the load switch. The input voltage should always remain greater than the output load voltage, maintaining a reverse bias on the internal parasitic diode. Conditions where V_{OUT} might exceed V_{IN} should be avoided since this would forward bias the internal parasitic diode and allow excessive current flow into the V_{OUT} pin and possibly damage the load switch.

In applications where there is a possibility of V_{OUT} exceeding V_{IN} for brief periods of time during normal operation, the use of a larger value C_{IN} capacitor is highly recommended. A larger value of C_{IN} with respect to C_{OUT} will effect a slower C_{IN} decay rate during shutdown, thus preventing V_{OUT} from exceeding V_{IN} . In applications where there is a greater danger of V_{OUT} exceeding

V_{IN} for extended periods of time, it is recommended to place a Schottky diode from V_{IN} to V_{OUT} (connecting the cathode to V_{IN} and anode to V_{OUT}). The Schottky diode forward voltage should be less than 0.45V.

Thermal Considerations and High Output Current Applications

The AAT4280 is designed to deliver a continuous output load current. The limiting characteristic for maximum safe operating output load current is package power dissipation. In order to obtain high operating currents, careful device layout and circuit operating conditions need to be taken into account.

The following discussions will assume the load switch is mounted on a printed circuit board utilizing the minimum recommended footprint, as stated in the Layout Considerations section of this datasheet.

At any given ambient temperature (T_A), the maximum package power dissipation can be determined by the following equation:

$$P_{D(MAX)} = \frac{[T_{J(MAX)} - T_A]}{\theta_{JA}}$$

Constants for the AAT4280 are maximum junction temperature, $T_{J(MAX)} = 125^\circ\text{C}$, and package thermal resistance, $\theta_{JA} = 120^\circ\text{C/W}$. Worst case conditions are calculated at the maximum operating temperature where $T_A = 85^\circ\text{C}$. Typical conditions are calculated under normal ambient conditions where $T_A = 25^\circ\text{C}$. At $T_A = 85^\circ\text{C}$, $P_{D(MAX)} = 333\text{mW}$. At $T_A = 25^\circ\text{C}$, $P_{D(MAX)} = 833\text{mW}$.

The maximum continuous output current for the AAT4280 is a function of the package power dissipation and the R_{DS} of the MOSFET at $T_{J(MAX)}$. The maximum R_{DS} of the MOSFET at $T_{J(MAX)}$ is calculated by increasing the maximum room temperature R_{DS} by the R_{DS} temperature coefficient. The temperature coefficient (T_C) is 2800ppm/ $^\circ\text{C}$. Therefore,

$$\text{MAX } R_{DS125^\circ\text{C}} = R_{DS25^\circ\text{C}} \cdot (1 + T_C \cdot \Delta T)$$

$$\text{MAX } R_{DS125^\circ\text{C}} = 120\text{m}\Omega \cdot (1 + 0.0028 \cdot (125^\circ\text{C} - 25^\circ\text{C})) = 154\text{m}\Omega$$

For maximum current, refer to the following equation:

$$I_{OUT(MAX)} < \frac{P_{D(MAX)}}{R_{DS}}$$

Slew Rate Controlled Load Switch

For example, if $V_{IN} = 5V$, $R_{DS(MAX)} = 154m\Omega$ and $T_A = 25^\circ C$, $I_{OUT(MAX)} = 2.3A$. If the output load current were to exceed 2.3A or if the ambient temperature were to increase, the internal die temperature would increase, and the device would be damaged.

Higher peak currents can be obtained with the AAT4280. To accomplish this, the device thermal resistance must be reduced by increasing the heat sink area or by operating the load switch in a duty-cycle manner.

High Peak Output Current Applications

Some applications require the load switch to operate at a continuous nominal current level with short duration, high-current peaks. The duty cycle for both output current levels must be taken into account. To do so, first calculate the power dissipation at the nominal continuous current level, and then add in the additional power dissipation due to the short duration, high-current peak scaled by the duty factor.

For example, a 4V system using an AAT4280 operates at a continuous 100mA load current level and has short 2A current peaks, as in a GSM application. The current peak occurs for 576 μs out of a 4.61ms period.

First, the current duty cycle is calculated:

$$\% \text{ Peak Duty Cycle: } X/100 = 576\mu s/4.61ms$$

$$\% \text{ Peak Duty Cycle} = 12.5\%$$

The load current is 100mA for 87.5% of the 4.61ms period and 2A for 12.5% of the period. Since the Electrical Characteristics do not report $R_{DS(MAX)}$ for 4V operation, it must be calculated approximately by consulting the chart of $R_{DS(ON)}$ vs. V_{IN} . The R_{DS} reported for 5V can be scaled by the ratio seen in the chart to derive the R_{DS} for a 4V V_{IN} : $120m\Omega \cdot 87m\Omega / 80m\Omega = 130m\Omega$. De-rated for temperature: $130m\Omega \times (1 + 0.0028 \cdot (125^\circ C - 25^\circ C)) = 166m\Omega$. The power dissipation for a 100mA load is calculated as follows:

$$P_{D(MAX)} = I_{OUT}^2 \cdot R_{DS}$$

$$P_{D(100mA)} = (100mA)^2 \cdot 166m\Omega$$

$$P_{D(100mA)} = 1.66mW$$

$$P_{D(87.5\%D/C)} = \%DC \cdot P_{D(100mA)}$$

$$P_{D(87.5\%D/C)} = 0.875 \cdot 1.66mW$$

$$P_{D(87.5\%D/C)} = 1.45mW$$

The power dissipation for 100mA load at 87.5% duty cycle is 1.45mW. Now the power dissipation for the remaining 12.5% of the duty cycle at 2A is calculated:

$$P_{D(MAX)} = I_{OUT}^2 \cdot R_{DS}$$

$$P_{D(2A)} = (2A)^2 \cdot 166m\Omega$$

$$P_{D(2A)} = 664mW$$

$$P_{D(12.5\%D/C)} = \%DC \cdot P_{D(2A)}$$

$$P_{D(12.5\%D/C)} = 0.125 \cdot 664mW$$

$$P_{D(12.5\%D/C)} = 83mW$$

The power dissipation for 2A load at 12.5% duty cycle is 83mW. Finally, the two power figures are summed to determine the total true power dissipation under the varied load.

$$P_{D(total)} = P_{D(100mA)} + P_{D(2A)}$$

$$P_{D(total)} = 1.45mW + 83mW$$

$$P_{D(total)} = 84.5mW$$

The maximum power dissipation for the AAT4280 operating at an ambient temperature of 85 $^\circ C$ is 333mW. The device in this example will have a total power dissipation of 84.5mW. This is well within the thermal limits for safe operation of the device; in fact, at 85 $^\circ C$, the AAT4280 will handle a 2A pulse for up to 50% duty cycle. At lower ambient temperatures, the duty cycle can be further increased.

Printed Circuit Board Layout Recommendations

For proper thermal management and to take advantage of the low $R_{DS(ON)}$ of the AAT4280, a few circuit board layout rules should be followed: V_{IN} and V_{OUT} should be routed using wider than normal traces, and GND should be connected to a ground plane. To maximize package thermal dissipation and power handling capacity of the AAT4280 SOT23-6/ SC70JW-8 package, the ground plane area connected to the ground pins should be made as large as possible. For best performance, C_{IN} and C_{OUT} should be placed close to the package pins.

Evaluation Board Layout

The AAT4280 evaluation layout follows the printed circuit board layout recommendations, and can be used for good applications layout. Refer to Figures 1 through 3.

Note: Board layout shown is not to scale.

AAT4280

Slew Rate Controlled Load Switch

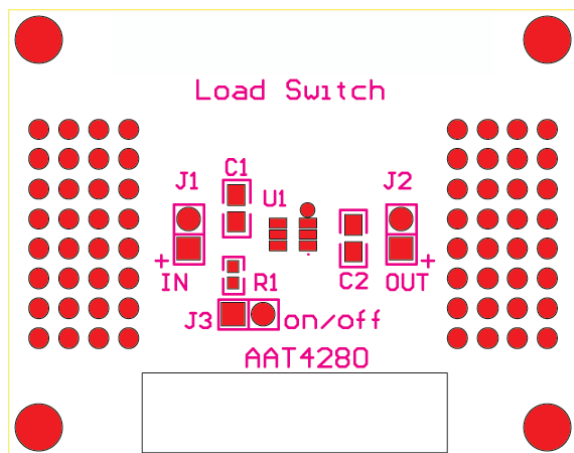

Figure 1: AAT4280 Evaluation Board Top Side Silk Screen Layout / Assembly Drawing.

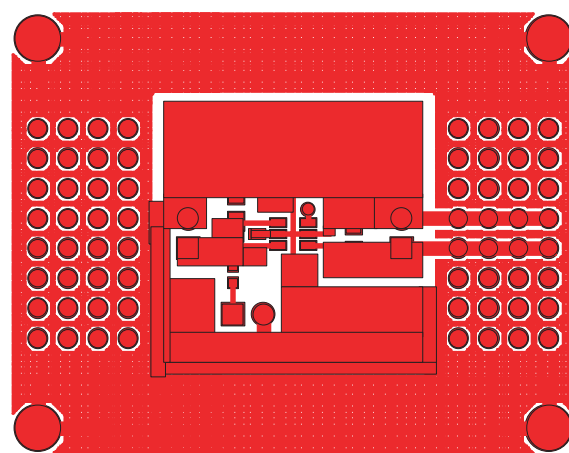

Figure 2: AAT4280 Evaluation Board Component Side Layout.

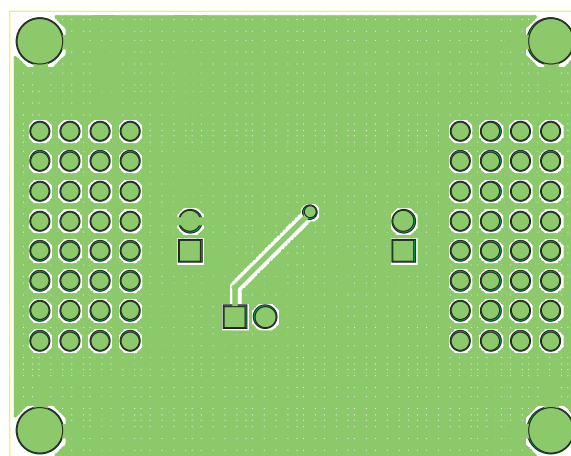

Figure 3: AAT4280 Evaluation Board Solder Side Layout.

AAT4280

Slew Rate Controlled Load Switch

Ordering Information

Device Option	Package	Marking ¹	Part Number (Tape and Reel) ²
AAT4280-1	SOT23-6	COXY	AAT4280IGU-1-T1
AAT4280-2	SOT23-6	BZXY	AAT4280IGU-2-T1
AAT4280-3	SOT23-6	CJXY	AAT4280IGU-3-T1
AAT4280-1	SC70JW-8	COXY	AAT4280IJS-1-T1
AAT4280-2	SC70JW-8	BZXY	AAT4280IJS-2-T1
AAT4280-3	SC70JW-8	CJXY	AAT4280IJS-3-T1



Skyworks Green™ products are compliant with all applicable legislation and are halogen-free. For additional information, refer to *Skyworks Definition of Green™*, document number SQ04-0074.

Package Information

SOT23-6

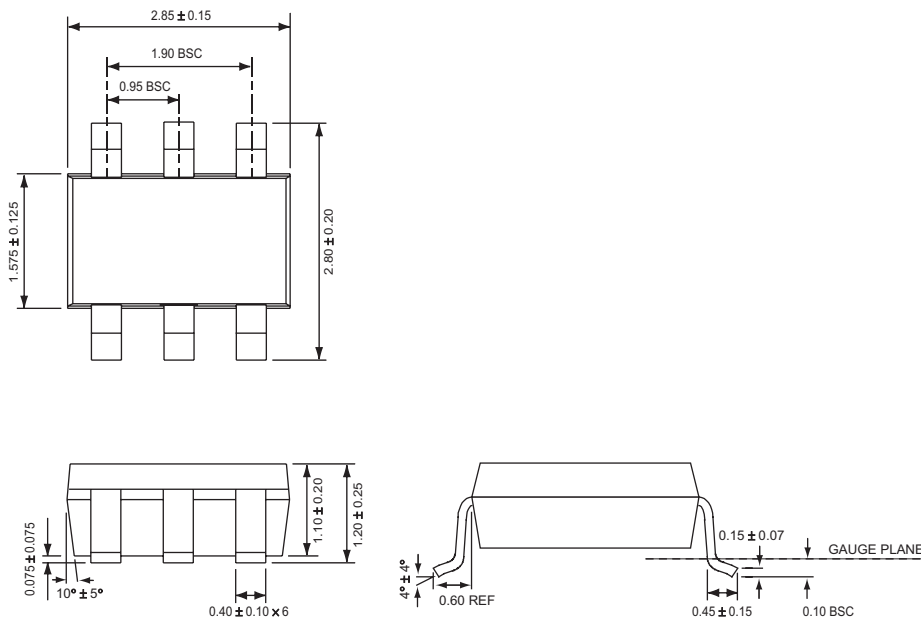

All dimensions in millimeters.

1. XYY = assembly and date code.
 2. Sample stock is generally held on all part numbers listed in **BOLD**.

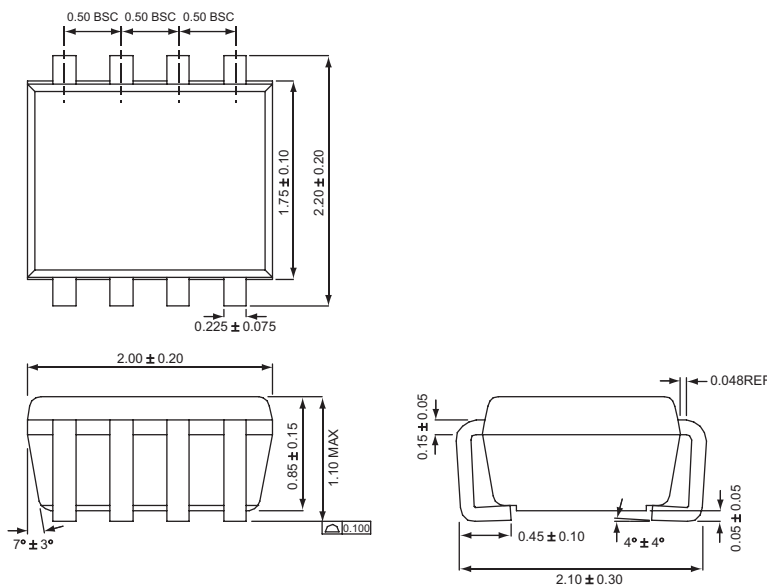
SC70JW-8

All dimensions in millimeters.

Copyright © 2012 Skyworks Solutions, Inc. All Rights Reserved.

Information in this document is provided in connection with Skyworks Solutions, Inc. ("Skyworks") products or services. These materials, including the information contained herein, are provided by Skyworks as a service to its customers and may be used for informational purposes only by the customer. Skyworks assumes no responsibility for errors or omissions in these materials or the information contained herein. Skyworks may change its documentation, products, services, specifications or product descriptions at any time, without notice. Skyworks makes no commitment to update the materials or information and shall have no responsibility whatsoever for conflicts, incompatibilities, or other difficulties arising from any future changes.

No license, whether express, implied, by estoppel or otherwise, is granted to any intellectual property rights by this document. Skyworks assumes no liability for any materials, products or information provided hereunder, including the sale, distribution, reproduction or use of Skyworks products, information or materials, except as may be provided in Skyworks Terms and Conditions of Sale.

THE MATERIALS, PRODUCTS AND INFORMATION ARE PROVIDED "AS IS" WITHOUT WARRANTY OF ANY KIND, WHETHER EXPRESS, IMPLIED, STATUTORY, OR OTHERWISE, INCLUDING FITNESS FOR A PARTICULAR PURPOSE OR USE, MERCHANTABILITY, PERFORMANCE, QUALITY OR NON-INFRINGEMENT OF ANY INTELLECTUAL PROPERTY RIGHT; ALL SUCH WARRANTIES ARE HEREBY EXPRESSLY DISCLAIMED. SKYWORKS DOES NOT WARRANT THE ACCURACY OR COMPLETENESS OF THE INFORMATION, TEXT, GRAPHICS OR OTHER ITEMS CONTAINED WITHIN THESE MATERIALS. SKYWORKS SHALL NOT BE LIABLE FOR ANY DAMAGES, INCLUDING BUT NOT LIMITED TO ANY SPECIAL, INDIRECT, INCIDENTAL, STATUTORY, OR CONSEQUENTIAL DAMAGES, INCLUDING WITHOUT LIMITATION, LOST REVENUES OR LOST PROFITS THAT MAY RESULT FROM THE USE OF THE MATERIALS OR INFORMATION, WHETHER OR NOT THE RECIPIENT OF MATERIALS HAS BEEN ADVISED OF THE POSSIBILITY OF SUCH DAMAGE.

Skyworks products are not intended for use in medical, lifesaving or life-sustaining applications, or other equipment in which the failure of the Skyworks products could lead to personal injury, death, physical or environmental damage. Skyworks customers using or selling Skyworks products for use in such applications do so at their own risk and agree to fully indemnify Skyworks for any damages resulting from such improper use or sale.

Customers are responsible for their products and applications using Skyworks products, which may deviate from published specifications as a result of design defects, errors, or operation of products outside of published parameters or design specifications. Customers should include design and operating safeguards to minimize these and other risks. Skyworks assumes no liability for applications assistance, customer product design, or damage to any equipment resulting from the use of Skyworks products outside of stated published specifications or parameters.

Skyworks, the Skyworks symbol, and "Breakthrough Simplicity" are trademarks or registered trademarks of Skyworks Solutions, Inc., in the United States and other countries. Third-party brands and names are for identification purposes only, and are the property of their respective owners. Additional information, including relevant terms and conditions, posted at www.skyworksinc.com, are incorporated by reference.

Looking for pricing, stock, or lifecycle information?

Click below to explore more details on WIN SOURCE:

- ⊖ [View AAT4280IGU-1-T1 on WIN SOURCE](#)
- ⊖ [Skyworks Solutions Inc. Information](#)

Optimize Your Supply Chain with WIN SOURCE Solutions

- ✓ Global Sourcing Solution
- ✓ Obsolete Management
- ✓ Cost Control Management
- ✓ Shortage Management
- ✓ Alternative Solution
- ✓ Excess Inventory Management