



**THE DATASHEET OF
AAT3681AIJS-4.2-T1**



500mA USB Port or AC Adapter Li-Ion/Polymer Battery Charger

General Description

The AAT3681A BatteryManager is an integrated single cell lithium-ion/polymer battery charger IC, designed to operate from a DC power source or USB port up to an input voltage of 7.5V. It requires just one external component.

The AAT3681A precisely regulates battery charge voltage and current for 4.2V (4.375V option) lithium-ion/polymer battery cells. When charged from an AC adapter or USB port, the battery charging current can be set by an external resistor up to 500mA.

Battery charge state is continuously monitored for fault conditions. In the event of an over-voltage, short-circuit, or over-temperature failure, the device will automatically shut down, thus protecting the charging device, control system, and the battery under charge. A status monitor output pin is provided to indicate the battery charge status by directly driving an external LED.

The AAT3681A is available in a Pb-free, thermally enhanced, space-saving 8-pin 2.0 × 2.0mm SC70JW package and is specified for operation over the -40°C to +85°C temperature range.

Features

- USB or AC Adapter System Power Charger
 - Programmable from 15mA to 500mA
- 4.0V ~ 7.5V Input Voltage Range
- High Level of Integration with Internal:
 - Charging Device
 - Reverse Blocking Diode
- Constant Regulated Output Voltage:
 - 4.1 in AAT3681A-5
 - 4.2 in AAT3681A-1/-2/-4
- Automatic Current Sensing
- Automatic Recharge Sequencing
- Full Battery Charge Auto Turn Off/Sleep Mode/Charge Termination
- Shutdown Current <1µA
- Automatic Trickle Charge for Battery Pre-Conditioning (AAT3681A-1/AAT3681A-4 is No Trickle Charge Option)
- Over-Voltage and Emergency Thermal Protection
- Power On Reset and Soft Start
- LED Status Pin
- 8-Pin 2.0 × 2.0mm SC70JW Package

Applications

- Bluetooth® Headsets
- DECT Headsets
- Digital Still Cameras
- MP3, Portable Music, and Portable Media Players
- Personal Data Assistants (PDAs)
- Wrist Watches
- Other Lithium-Ion/Polymer Battery-Powered Devices

Typical Application

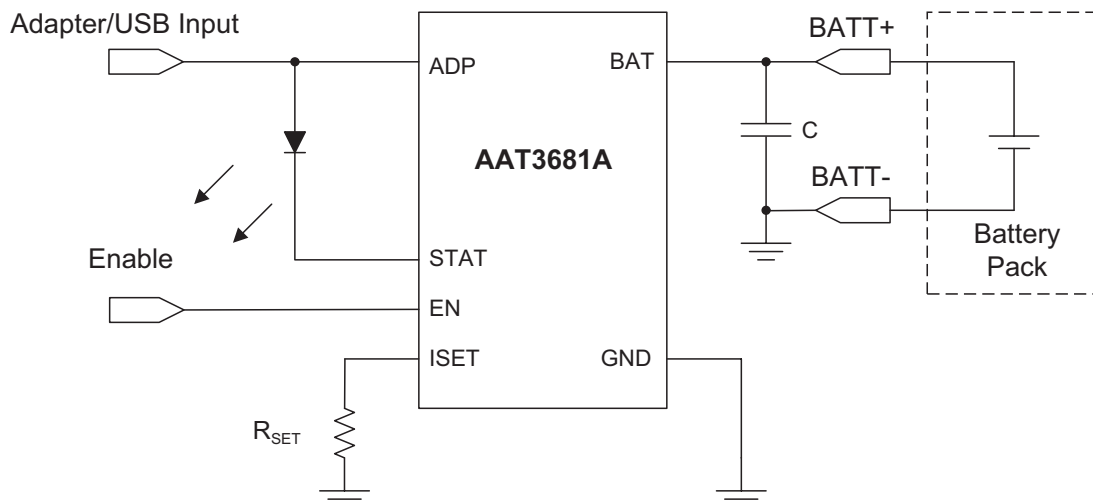

AAT3681A**500mA USB Port or AC Adapter Li-Ion/Polymer Battery Charger****Pin Description**

Pin #	Symbol	Type	Function
1	EN	In	Enable pin. AAT3681A, AAT3681A-1, AAT3681A-4, AAT3681A-5: Logic high enables the IC (internal pull down 6MΩ resistor). AAT3681A-2: Logic low enables the IC (internal pull down resistor).
2	ISET	In/Out	Connect resistor here to set the charge current.
3	BAT	In/Out	Battery charging and sensing.
4	ADP	Power In	Input from USB/adapter charger.
5	STAT	Out	Open drain status pin.
6, 7, 8	GND	Power	Ground connection.

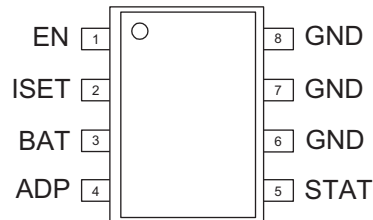
Pin Configuration**SC70JW-8
(Top View)**

AAT3681A**500mA USB Port or AC Adapter Li-Ion/Polymer Battery Charger****AAT3681A Feature Options**

Product	Trickle Charge	Enable	Charge Termination Threshold Current	Constant Regulated Output Voltage $V_{CO(REG)}$
AAT3681A	Yes	Active High	10%	4.2 (Optional 4.1V)
AAT3681A-1	No	Active High	10%	4.2
AAT3681A-2	Yes	Active Low	10%	4.2
AAT3681A-4	No	Active High	10%	4.2
AAT3681A-5	Yes	Active High	10%	4.1

Absolute Maximum Ratings¹

Symbol	Description	Value	Units
V_P	ADP Continuous	-0.3 to 8.0	V
V_N	BAT, STAT, ISET, EN	-0.3 to $V_P + 0.3$	
T_A	Operating Temperature Range	-40 to 85	°C
T_J	Junction Temperature Range	-40 to 150	
T_{LEAD}	Maximum Soldering Temperature (at Leads)	300	

Thermal Information²

Symbol	Description	Value	Units
P_D	Maximum Power Dissipation	0.687	W
θ_{JA}	Maximum Thermal Resistance	160	°C/W

1. Stresses above those listed in Absolute Maximum Ratings may cause permanent damage to the device. Functional operation at conditions other than the operating conditions specified is not implied. Only one Absolute Maximum Rating should be applied at any one time.

2. Mounted on an FR4 board.

DATA SHEET

AAT3681A

500mA USB Port or AC Adapter Li-Ion/Polymer Battery Charger

Electrical Characteristics¹

$V_{ADP} = 5V$, $T_A = -40^{\circ}C$ to $+85^{\circ}C$, unless otherwise noted. Typical values are $T_A = 25^{\circ}C$.

Symbol	Description	Conditions	Min	Typ	Max	Units
Operation						
V_{ADP}	Adapter Voltage Range		4.0		7.5	V
V_{UVLO}	Under-Voltage Lockout (UVLO)	Rising Edge for AAT3681A/-1/-2		3.0		V
		Rising Edge for AAT3681A-4/-5		3.2		V
	UVLO Hysteresis			150		mV
I_{OP}	Operating Current	Charge Current = 200mA		0.5	1	mA
$I_{SHUTDOWN}$	Shutdown Current	$V_{BAT} = 4.25V$, $V_{EN} = GND$ (AAT3681A, AAT3681A-1, AAT3681A-4)		0.3	1	μA
		$V_{BAT} = 4.25V$, $V_{EN} = 5V$ (AAT3681A-2)				
$I_{LEAKAGE}$	Reverse Leakage Current from BAT Pin	$V_{BAT} = 4V$, ADP Pin Open		0.4	2	μA
Voltage Regulation						
$V_{CO(REG)}$	Constant Output Voltage Accuracy	For AAT3681A/-1/-2/-4	4.158	4.20	4.242	V
		AAT3681A-5 Only	4.059	4.10	4.141	V
$\Delta V_{CH}/V_{CH}$	Output Charge Voltage Tolerance			0.5		%
V_{MIN}	Preconditioning Voltage Threshold	AAT3681A, AAT3681A-2 Only	2.85	3.0	3.15	V
V_{RCH}	Battery Recharge Voltage Threshold	AAT3681A, AAT3681A-1, AAT3681A-2 and AAT3681A-4 Only; Measured from $V_{CO(REG)}$		-0.1		V
Current Regulation						
I_{CH}	Charge Current Programmable Range ²		15		500	mA
$\Delta I_{CH}/I_{CH}$	Charge Current Regulation Tolerance			10		%
V_{SET}	ISET Pin Voltage			2		V
K_{I_A}	Current Set Factor: I_{CH}/I_{SET}			800		
Charging Devices						
$R_{DS(ON)}$	Charging Transistor On Resistance	$V_{ADP} = 5.5V$		0.6	1	Ω
Logic Control/Protection						
$V_{EN(H)}$	Input High Threshold		1.6			V
$V_{EN(L)}$	Input Low Threshold				0.4	V
V_{STAT}	Output Low Voltage	STAT Pin Sinks 4mA			0.4	V
I_{STAT}	STAT Pin Current Sink Capability				8	mA
V_{OVP}	Over-Voltage Protection Threshold			4.4		V
I_{TK}/I_{CH}	Pre-Charge Current	$I_{CH} = 100mA$; AAT3681A, AAT3681A-2, and AAT3681A-5 Only		10		%
I_{TERM}/I_{CH}	Charge Termination Threshold Current	AAT3681A, AAT3681A-1, AAT3681A-2, AAT3681A-4, and AAT3681A-5 Only		10		%

- The AAT3681A output charge voltage is specified over the 0° to $70^{\circ}C$ ambient temperature range; operation over the $-40^{\circ}C$ to $+85^{\circ}C$ temperature range is guaranteed by design.
- Achievable charge current may be limited by power dissipation capability of the package under certain operating conditions. See "Thermal Considerations" section of this datasheet.

AAT3681A

500mA USB Port or AC Adapter Li-Ion/Polymer Battery Charger

Typical Characteristics

Constant Charging Current vs. Set Resistor Values

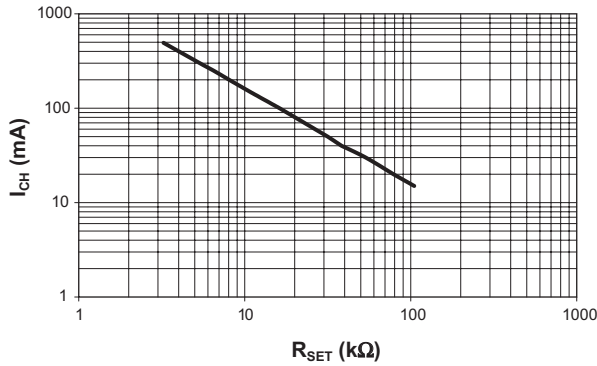

Operating Supply Current vs. R_{SET}
($V_{IN} = 5V$)

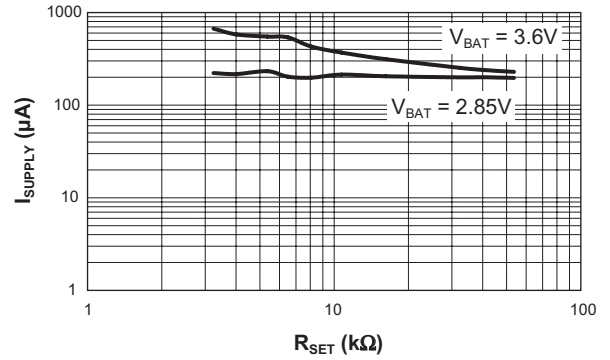

Constant Regulated Output Voltage vs. Input Voltage
(AAT3681A, AAT3681A-1/-2/-4)

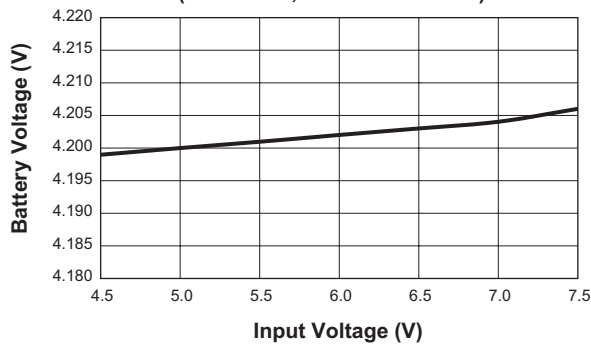

Constant Regulated Output Voltage vs. Temperature
(AAT3681A, AAT3681A-1/-2/-4; $R_{SET} = 8.06k\Omega$)

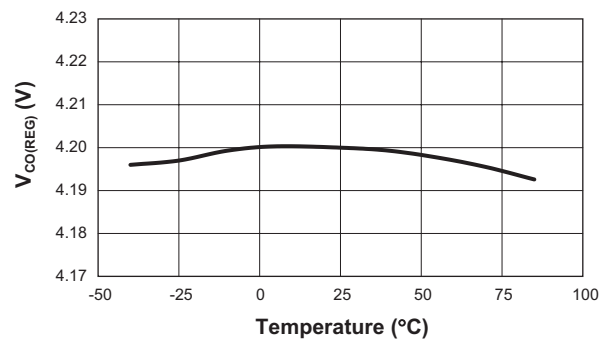

Constant Regulated Output Voltage vs. Input Voltage
(AAT3681A-4.1, AAT3681A-5 Only)

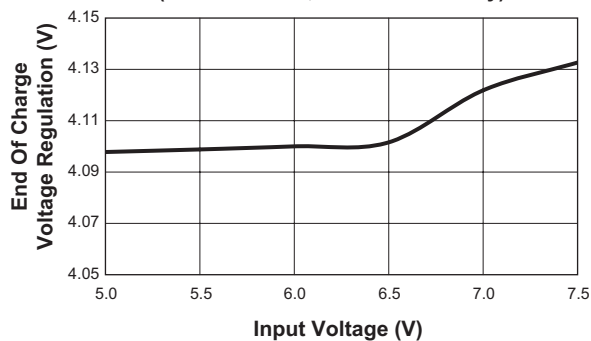

Constant Regulated Output Voltage vs. Temperature
(AAT3681A-4.1 and AAT3681A-5 Only)

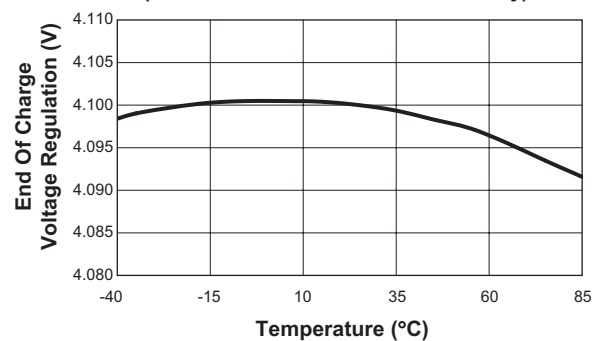

DATA SHEET

AAT3681A

500mA USB Port or AC Adapter Li-Ion/Polymer Battery Charger

Typical Characteristics

Charging Current vs. Battery Voltage
(AAT3681A, AAT3681A-2, and AAT3681A-5 only)

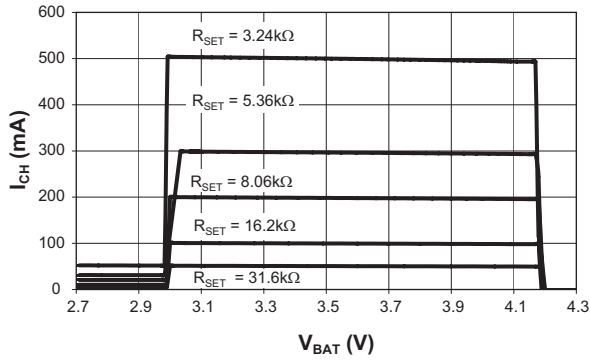

Charging Current vs. Battery Voltage
(AAT3681A-1 and AAT3681A-4 only)

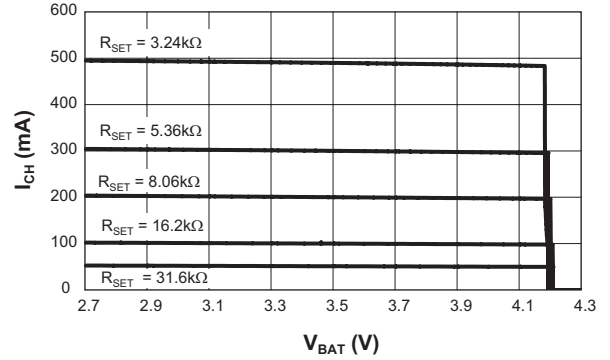

Battery Charging Current vs. Input Voltage
(AAT3681A-4.1 and AAT3681A-5 only; $V_{CO(REG)} = 4.1V$)

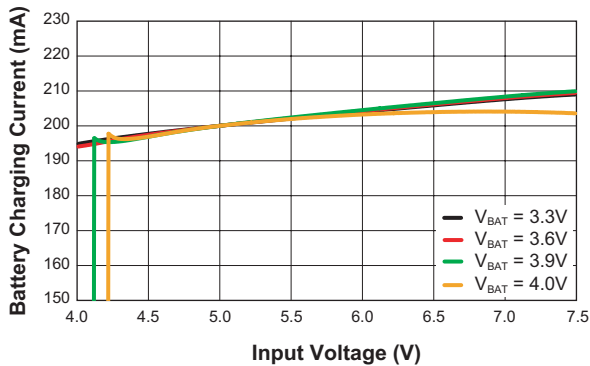

Charging Current vs. Battery Voltage
(AAT3681A-4.1 and AAT3681A-5 Only)

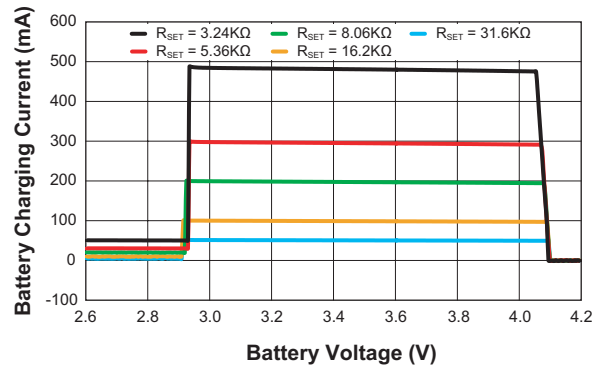

Battery Charging Current vs. Battery Voltage
(AAT3681A-4.1 and AAT3681A-5 Only)

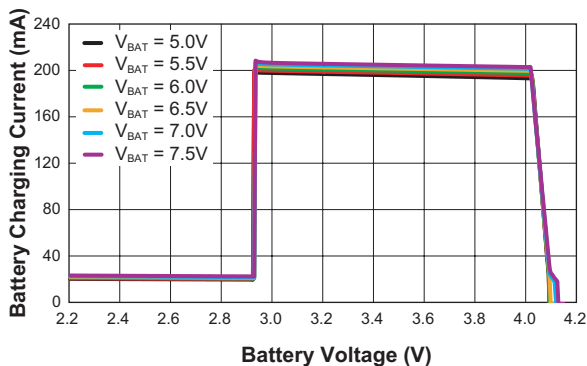

Constant Charging Current vs. Temperature
($R_{SET} = 8.06k\Omega$)

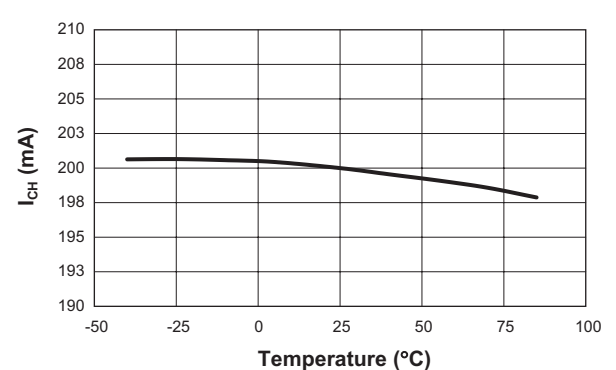

AAT3681A

500mA USB Port or AC Adapter Li-Ion/Polymer Battery Charger

Typical Characteristics

Constant Charging Current vs. Input Voltage
($R_{SET} = 8.06k\Omega$)

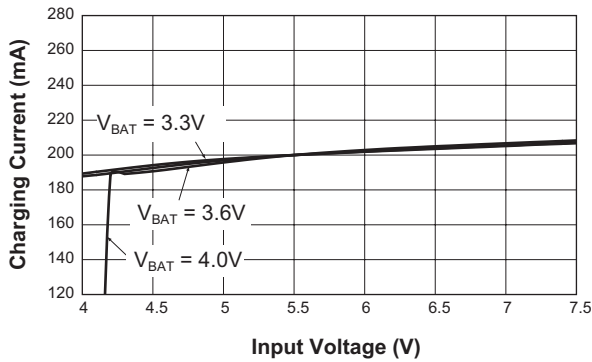

Operating Current vs. Temperature
($R_{SET} = 8.06k\Omega$)

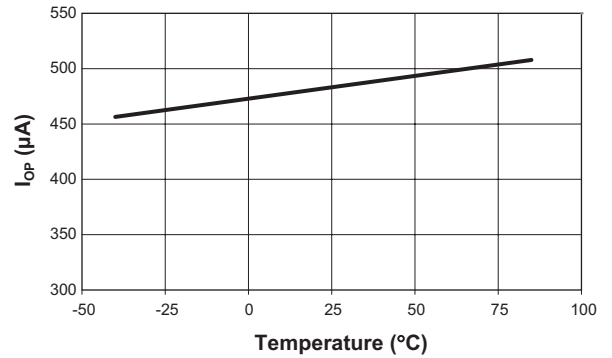

Preconditioning Threshold Voltage vs. Temperature
($R_{SET} = 8.06k\Omega$; AAT3681A, AAT3681A-2, and AAT3681A-5 Only)

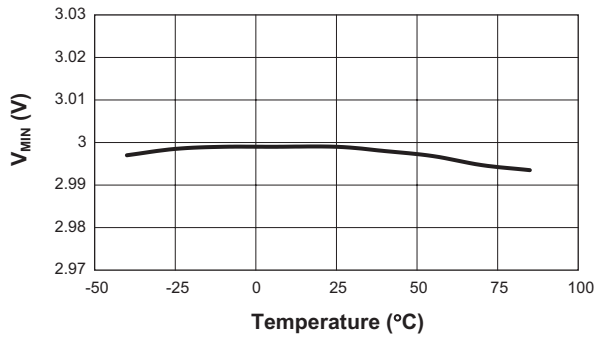

Preconditioning Voltage Threshold vs. Input Voltage
(AAT3681A-4.1 and AAT3681A-5 Only)

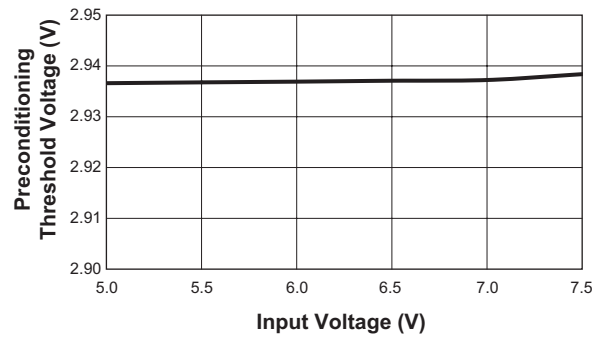

Preconditioning Threshold Voltage vs. Temperature
(AAT3681AIJS-4.1-T1 Only)

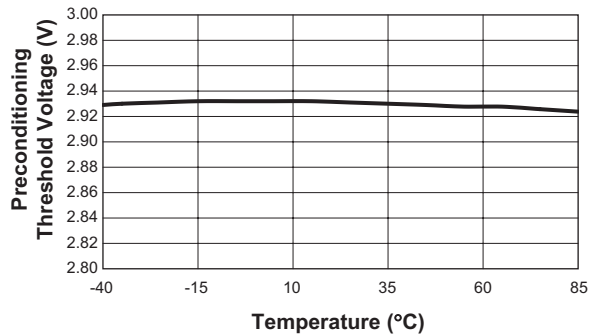

Preconditioning Charge Current vs. Temperature
($R_{SET} = 8.06k\Omega$; AAT3681A, AAT3681A-2, and AAT3681A-5 Only)

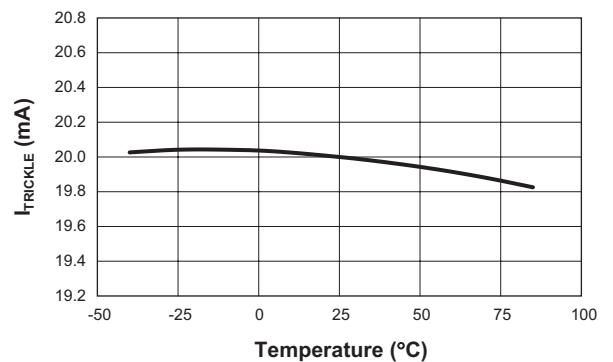

AAT3681A

500mA USB Port or AC Adapter Li-Ion/Polymer Battery Charger

Typical Characteristics

Preconditioning Charge Current vs. Input Voltage
(AAT3681A, AAT3681A-2, and AAT3681A-5 Only)

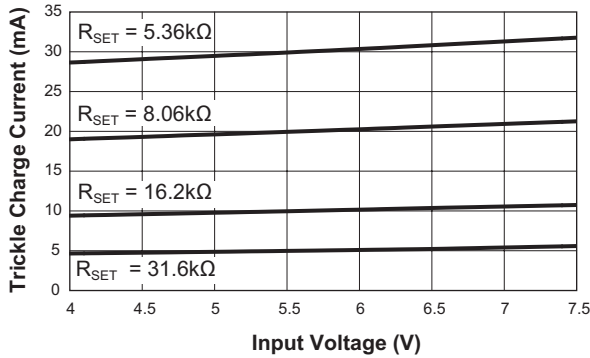

Recharging Threshold Voltage vs. Temperature
($R_{SET} = 8.06k\Omega$; AAT3681A, AAT3681A-1, AAT3681A-2, and AAT3681A-4 Only)

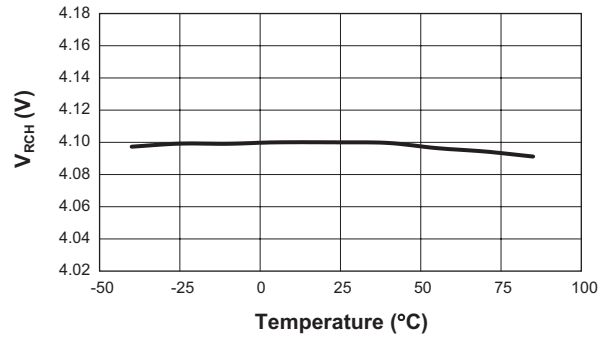

Recharging Threshold Voltage vs. Temperature
(AAT3681A-4.1 and AAT3681A-5 Only)

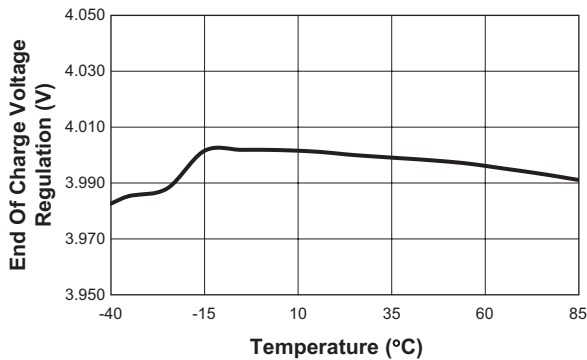

Shutdown Current vs. Supply Voltage
($R_{SET} = 8.06k\Omega$)

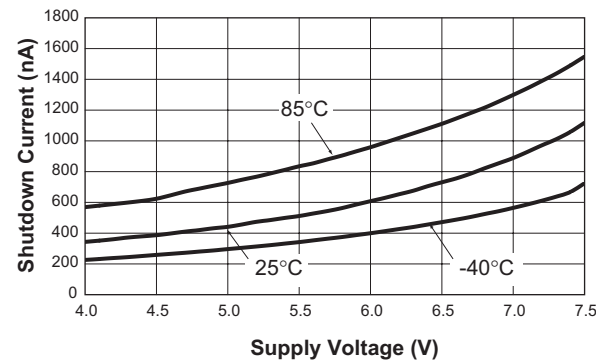

Input Enable High Voltage vs. Supply Voltage
($R_{SET} = 8.06k\Omega$)

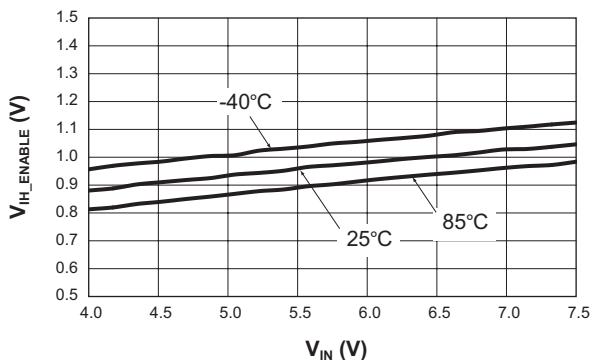

Input Enable Low Voltage vs. Supply Voltage
($R_{SET} = 8.06k\Omega$)

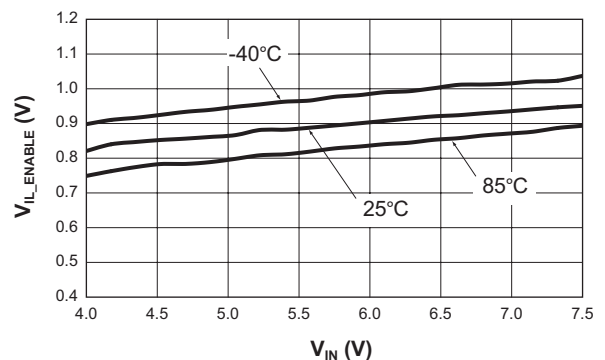

AAT3681A

500mA USB Port or AC Adapter Li-Ion/Polymer Battery Charger

Functional Block Diagram

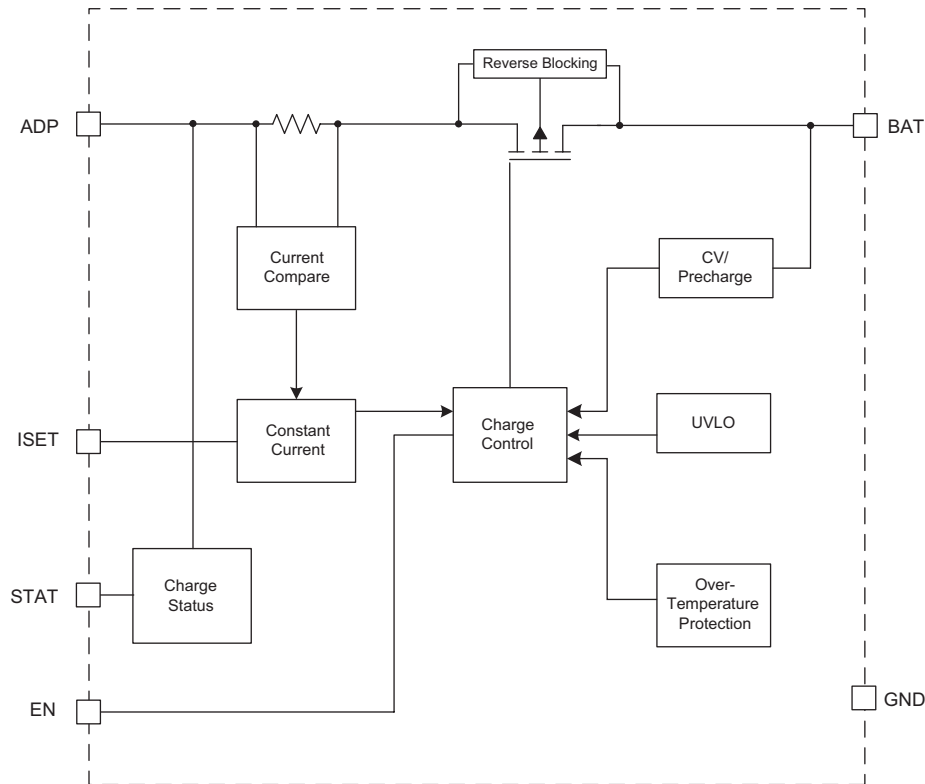

Functional Description

The AAT3681A is a high performance battery charger designed for single cell lithium-ion/polymer batteries with up to 500mA of charge current from an external power source. It is a stand-alone charging solution, with just one external component required for complete functionality. The AAT3681A precisely regulates battery charge voltage and current for 4.2V lithium-ion/polymer battery cells. The AAT3681A-5 regulates battery charge voltage for 4.1V Lithium-ion/polymer battery cells.

The adapter/USB charge input constant current level can be programmed up to 500mA for rapid charging applications. The AAT3681A/-1/-2/-4/-5 is rated for operation from -40°C to +85°C. In the event of operating ambient temperatures exceeding the power dissipation abilities of the device package for a given constant current charge level, the charge control will enter into thermal limit.

A status monitor output pin is provided to indicate the battery charge state by directly driving one external LED.

Device junction temperature and charge state are fully monitored for fault conditions. In the event of an over-voltage or over-temperature failure, the device will automatically shut down, protecting the charging device, control system, and the battery under charge.

Charging Operation

The AAT3681A has four basic modes for the battery charge cycle: pre-conditioning/trickle charge; constant current/fast charge; constant voltage; and charge termination (see Figure 1). (AAT3681A-1 and AAT3681A-4 do not have trickle charge.)

500mA USB Port or AC Adapter Li-Ion/Polymer Battery Charger

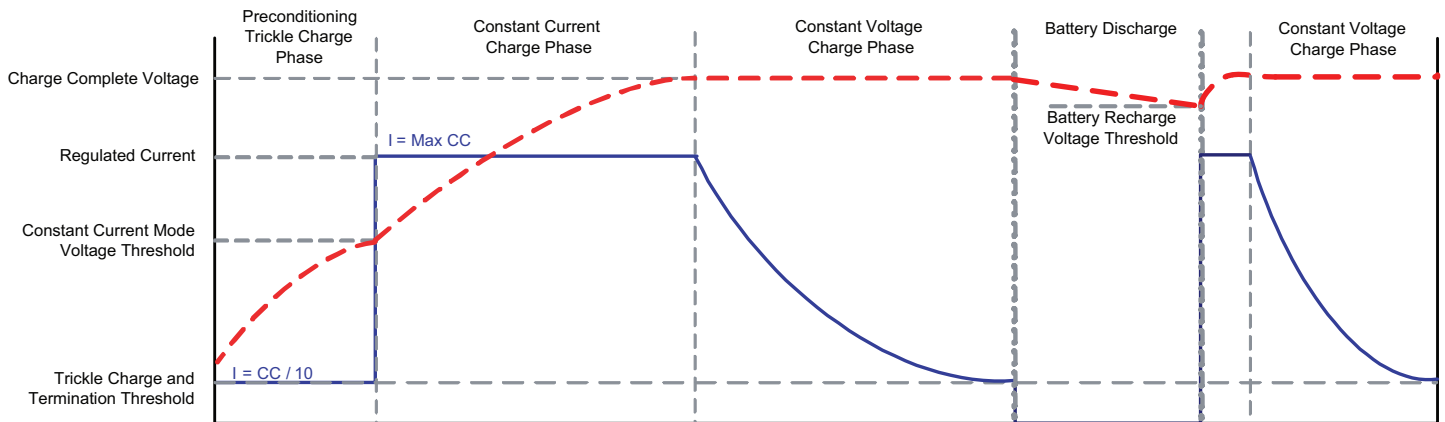

Figure 1: Current vs. Voltage Profile During Charging Phases.

Battery Preconditioning

Before the start of charging, the AAT3681A checks several conditions in order to assure a safe charging environment. The input supply must be above the minimum operating voltage, or under-voltage lockout threshold (V_{UVLO}), for the charging sequence to begin. When these conditions have been met and a battery is connected to the BAT pin, the AAT3681A checks the state of the battery. If the cell voltage is below the preconditioning voltage threshold (V_{MIN}), the charge control begins preconditioning the cell. The battery preconditioning trickle charge current is equal to the fast charge constant current divided by 10. For example, if the programmed fast charge current is 300mA, then the preconditioning mode (trickle charge) current will be 30mA. Cell preconditioning is a safety precaution for deeply discharged battery cells and also aids in limiting power dissipation in the pass transistor when the voltage across the device is at the greatest potential.

Constant Current Charging

Battery cell preconditioning continues until the voltage on the BAT pin exceeds the preconditioning voltage threshold (V_{MIN}). At this point, the AAT3681A begins the constant current charging phase. The charge constant current (I_{CH}) amplitude is programmed by the user via the R_{SET} resistor. The AAT3681A remains in the constant current charge mode until the battery reaches the constant voltage regulation point, $V_{CO(REG)}$.

Constant Voltage Charging

The system transitions to a constant voltage charging mode when the battery voltage reaches the constant output voltage charge regulation threshold ($V_{CO(REG)}$) during the constant current fast charge phase. The regulation voltage level is factory programmed to 4.2V ($\pm 0.5\%$) for AAT3681A/-1/-2/-4 and 4.1 ($\pm 0.5\%$) for AAT3681A-5. Charge current in the constant voltage mode drops as the battery cell under charge reaches its maximum capacity.

End of Charge Cycle Termination and Recharge Sequence

When the charge current drops to 10% of the programmed fast charge current level in the constant voltage mode, the device terminates charging and goes into a sleep state. The charger will remain in a sleep state until the battery voltage decreases to a level below the battery recharge voltage threshold (V_{RCH}).

Consuming very low current in sleep state, the AAT3681A minimizes battery drain when it is not charging. This feature is particularly useful in applications where the input supply level may fall below the battery charge or under-voltage lockout level. In such cases where the AAT3681A input voltage drops, the device will enter sleep state and automatically resume charging once the input supply has recovered from the fault condition.

AAT3681A

500mA USB Port or AC Adapter Li-Ion/Polymer Battery Charger

System Operation Flow Chart

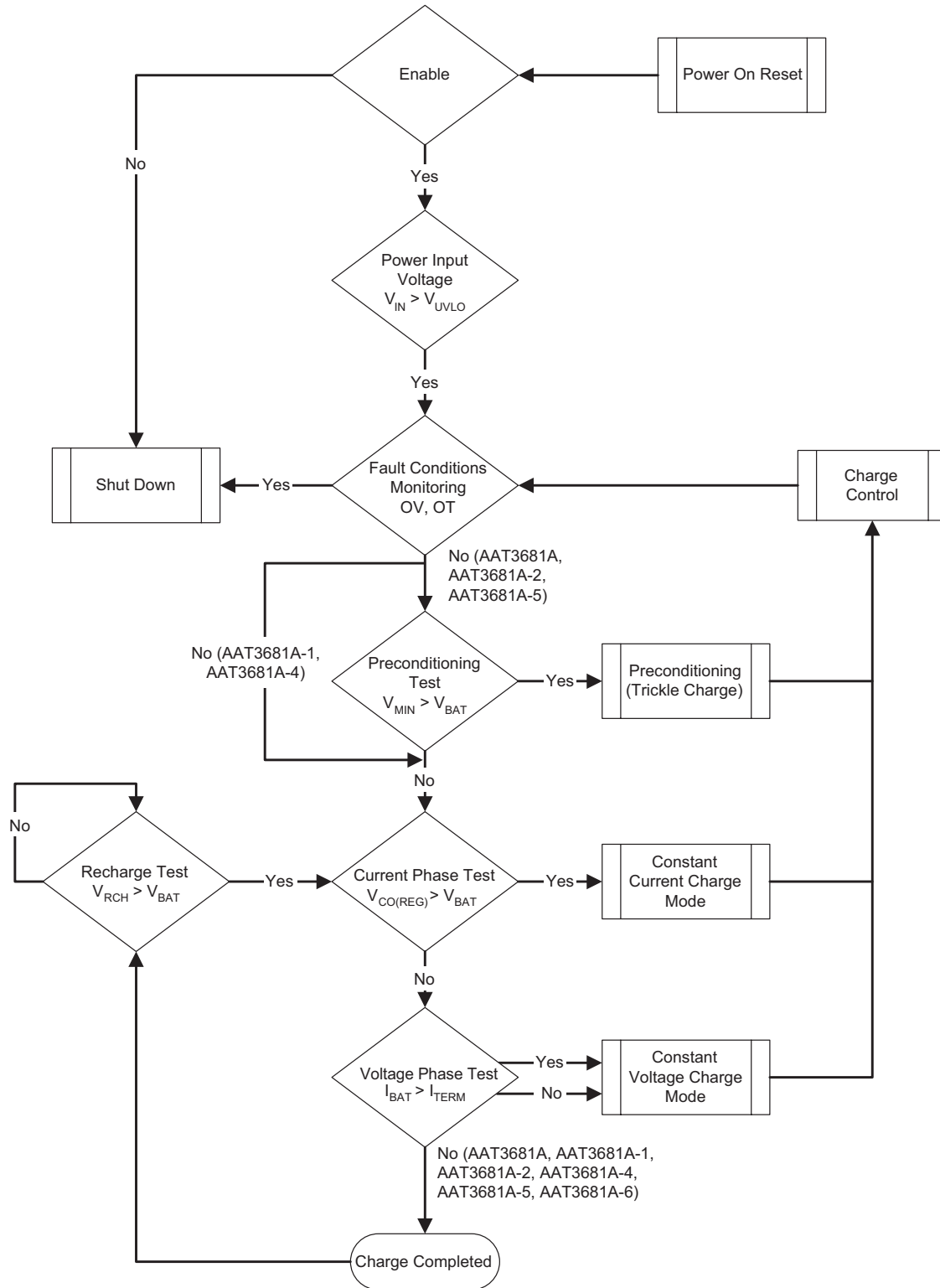

500mA USB Port or AC Adapter Li-Ion/Polymer Battery Charger

Application Information

Adapter or USB Power Input

Constant current charge levels up to 500mA may be programmed by the user when powered from a sufficient input power source. The AAT3681A will operate from the adapter input over a 4.0V to 7.5V range. The constant current fast charge current for the adapter input is set by the R_{SET} resistor connected between ISET and ground. Refer to Table 1 for recommended R_{SET} values for a desired constant current charge level.

Adapter Input Charge Inhibit and Resume

The AAT3681A has a UVLO and power on reset feature so that if the input supply to the ADP pin drops below the UVLO threshold, the charger will suspend charging and shut down. When power is re-applied to the ADP pin or the UVLO condition recovers, the system charge control will assess the state of charge on the battery cell and will automatically resume charging in the appropriate mode for the condition of the battery.

Enable / Disable

The AAT3681A provides an enable function to control the charger IC on and off. The EN pin functions as follows on the various AAT3681A options:

AAT3681A, AAT3681A-1, AAT3681A-4, and AAT3681A-5: The enable (EN) pin is internally pulled down through a 6M Ω resistor. When pulled to a logic high level, the AAT3681A is enabled. When left open or pulled to a logic low level, the AAT3681A will be shut down and forced into the sleep state.

AAT3681A-2: The enable (EN) pin is internally pulled down. When left open or pulled to a logic low level, the AAT3681A-2 is enabled. When pulled to a logic high level, the AAT3681A-2 will be shut down and forced into the sleep state.

Charging will be halted regardless of the battery voltage or charging state. When the device is re-enabled, the charge control circuit will automatically reset and resume charging functions with the appropriate charging mode based on the battery charge state and measured cell voltage on the BAT pin.

Programming Charge Current

The fast charge constant current charge level is user programmed with a set resistor placed between the ISET pin and ground. The accuracy of the fast charge, as well as the preconditioning trickle charge current, is dominated by the tolerance of the set resistor used. For this reason, a 1% tolerance metal film resistor is recommended for the set resistor function. Fast charge constant current levels from 15mA to 500mA may be set by selecting the appropriate resistor value from Table 1.

Nominal I_{CHARGE} (mA)	Set Resistor Value (k Ω)
500	3.24
450	3.57
400	4.12
350	4.64
300	5.36
250	6.49
200	8.06
150	10.7
100	16.2
50	31.6
40	38.3
30	53.6
20	78.7
15	105

Table 1: R_{SET} Values.

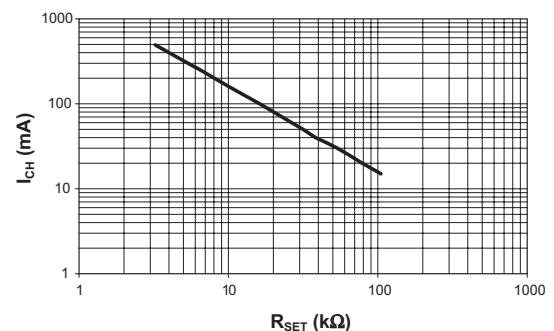

Figure 2: Constant Charging Current vs. Set Resistor Values.

Protection Circuitry

Over-Voltage Protection

An over-voltage event is defined as a condition where the voltage on the BAT pin exceeds the maximum battery charge voltage and is set by the over-voltage protection threshold (V_{OVP}). If an over-voltage condition

AAT3681A

500mA USB Port or AC Adapter Li-Ion/Polymer Battery Charger

occurs, the AAT3681A charge control will shut down the device until the voltage on the BAT pin drops below V_{OVP} . The AAT3681A will resume normal charging operation after the over-voltage condition is removed.

Over-Temperature Shutdown

The AAT3681A has a thermal protection control circuit which will shut down charging functions should the internal die temperature exceed the preset thermal limit threshold. Once the internal die temperature falls below the thermal limit, normal operation will resume the previous charging state.

Charge Status Output

The AAT3681A provides battery charge status via a status pin. This pin is internally connected to an N-channel open drain MOSFET, which can be used to drive an external LED. The status pin can indicate the following conditions:

Event Description	Status
No battery charging activity	OFF
Battery charging via adapter or USB port	ON
Charging completed	OFF

Table 2: LED Status Indicator.

The LED should be biased with as little current as necessary to create reasonable illumination; therefore, a ballast resistor should be placed between the LED cathode and the STAT pin. LED current consumption will add to the overall thermal power budget for the device package, hence it is good to keep the LED drive current to a minimum. A 2mA should be sufficient to drive most low-cost green or red LEDs. It is not recommended to exceed 8mA for driving an individual status LED.

The required ballast resistor values can be estimated using the following formulas:

$$R_1 = \frac{(V_{ADP} - V_{F(LED)})}{I_{LED}}$$

Example:

$$R_1 = \frac{(5.5V - 2.0V)}{2mA} = 1.75k\Omega$$

Note: Red LED forward voltage (V_F) is typically 2.0V @ 2mA.

Thermal Considerations

The AAT3681A is offered in a SC70JW-8 package which can provide up to 687mW of power dissipation when it is properly bonded to a printed circuit board and has a maximum thermal resistance of 160°C/W. Many considerations should be taken into account when designing the printed circuit board layout, as well as the placement of the charger IC package in proximity to other heat generating devices in a given application design. The ambient temperature around the charger IC will also have an effect on the thermal limits of a battery charging application. The maximum limits that can be expected for a given ambient condition can be estimated by the following discussion.

First, the maximum power dissipation for a given situation should be calculated:

$$P_{D(MAX)} = \frac{(T_{J(MAX)} - T_A)}{\theta_{JA}}$$

Where:

$P_{D(MAX)}$ = Maximum Power Dissipation (W)

θ_{JA} = Package Thermal Resistance (°C/W)

$T_{J(MAX)}$ = Maximum Device Junction Temperature (°C)
[135°C]

T_A = Ambient Temperature (°C)

Figure 3 shows the relationship of maximum power dissipation and ambient temperature of AAT3681A.

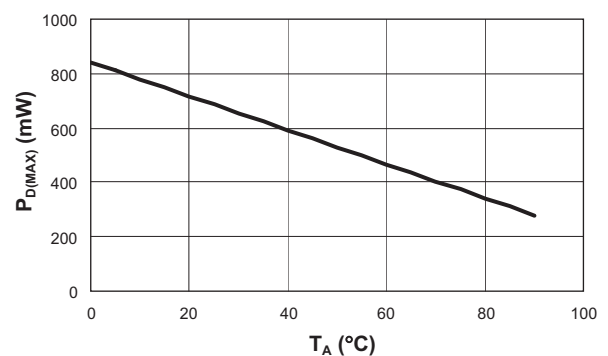

Figure 3: Maximum Power Dissipation.

AAT3681A

500mA USB Port or AC Adapter Li-Ion/Polymer Battery Charger

Next, the power dissipation can be calculated by the following equation:

$$P_D = [(V_{IN} - V_{BAT}) \cdot I_{CH} + (V_{IN} \cdot I_{OP})]$$

Where:

- P_D = Total Power Dissipation by the Device
- V_{IN} = Input Voltage
- V_{BAT} = Battery Voltage as Seen at the BAT Pin
- I_{CH} = Constant Charge Current Programmed for the Application
- I_{OP} = Quiescent Current Consumed by the Charger IC for Normal Operation [0.5mA]

By substitution, we can derive the maximum charge current before reaching the thermal limit condition (thermal cycling). The maximum charge current is the key factor when designing battery charger applications.

$$I_{CH(MAX)} = \frac{(P_{D(MAX)} - V_{IN} \cdot I_{OP})}{V_{IN} - V_{BAT}}$$

$$I_{CH(MAX)} = \frac{\frac{(T_{J(MAX)} - T_A)}{\theta_{JA}} - V_{IN} \cdot I_{OP}}{V_{IN} - V_{BAT}}$$

In general, the worst condition is the greatest voltage drop across the charger IC, when battery voltage is charged up to the preconditioning voltage threshold. Figure 4 shows the maximum charge current in different ambient temperatures without PCB thermal enhancements.

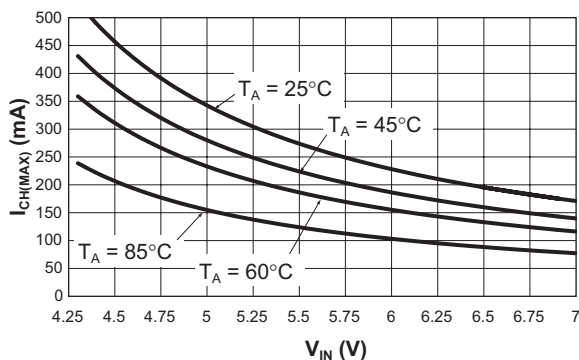

Figure 4: Maximum Charging Current Before Thermal Cycling Becomes Active.

Capacitor Selection

Input Capacitor

In general, it is good design practice to place a decoupling capacitor between the ADP pin and GND. An input capacitor in the range of 1μF to 22μF is recommended. If the source supply is unregulated, it may be necessary to increase the capacitance to keep the input voltage above the under-voltage lockout threshold during device enable and when battery charging is initiated. If the AAT3681A adapter input is to be used in a system with an external power supply source, such as a typical AC-to-DC wall adapter, then a C_{IN} capacitor in the range of 10μF should be used. A larger input capacitor in this application will minimize switching or power transient effects when the power supply is "hot plugged" in.

Output Capacitor

The AAT3681A only requires a 1μF ceramic capacitor on the BAT pin to maintain circuit stability. This value should be increased to 10μF or more if the battery connection is made any distance from the charger output. If the AAT3681A is to be used in applications where the battery can be removed from the charger, such as with desktop charging cradles, an output capacitor greater than 10μF may be required to prevent the device from cycling on and off when no battery is present.

Printed Circuit Board Layout Considerations

For the best results, it is recommended to physically place the battery pack as close as possible to the AAT3681A BAT pin. To minimize voltage drops on the PCB, keep the high current carrying traces adequately wide. Refer to the AAT3681A evaluation board for a good layout example (see Figures 5 and 6).

DATA SHEET

AAT3681A

500mA USB Port or AC Adapter Li-Ion/Polymer Battery Charger

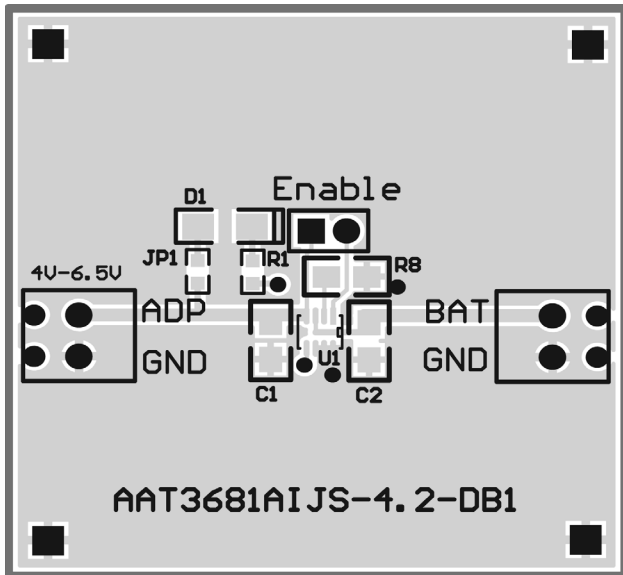

Figure 5: AAT3681A Evaluation Board Top Side Layout.

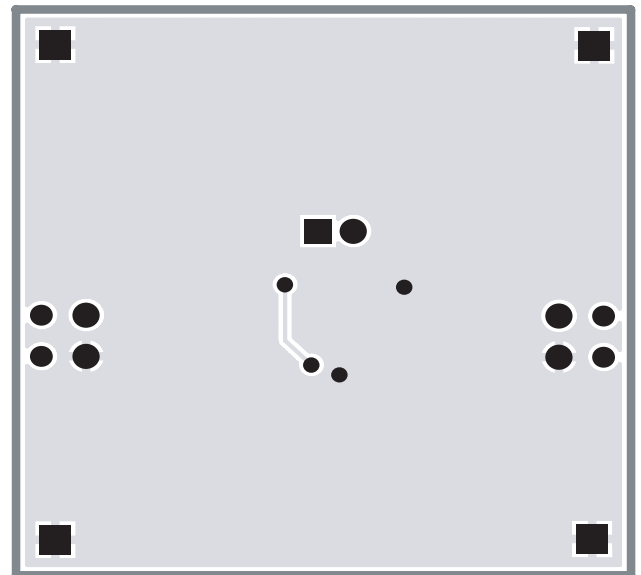

Figure 6: AAT3681A Evaluation Board Bottom Side Layout.

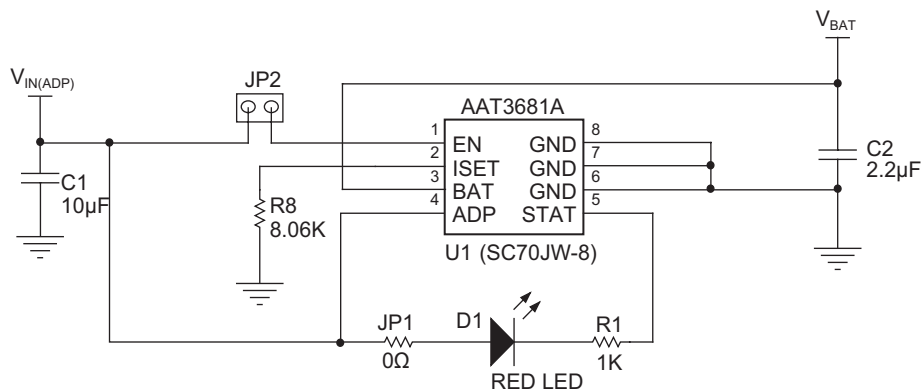

Figure 7: AAT3681A Evaluation Board Schematic Diagram.

Component	Part Number	Description	Manufacturer
U1	AAT3681AIJS-T1	USB/ADP Battery Charger; SC70JW-8 Package	Skyworks
R1	Chip Resistor	1kΩ, 5%, 1/4W; 0603	Vishay
R8	Chip Resistor	8.06kΩ, 1%, 1/4W; 0805	
JP1	Chip Resistor	0Ω, 5%, 1/4W; 0603	Murata
C1	GRM21BR61A106KE19L	Ceramic 10µF 10V 10% X5R 0805	
C2	GRM21BR71A225KA01L	Ceramic 2.2µF 10V 10% X7R 0805	
JP2	PRPN401PAEN	Connecting Header, 2mm Zip	Sullins Electronics
LED1	CMD15-21SRC/TR8	Red LED; 1206	Chicago Miniature Lamp

Table 3: AAT3681A Evaluation Board Bill of Materials.

DATA SHEET

AAT3681A

500mA USB Port or AC Adapter Li-Ion/Polymer Battery Charger

Ordering Information

Trickle Charge	Enable	Package	Marking ¹	Part Number (Tape and Reel) ²
Yes	Active High	SC70JW-8	E4XYY	AAT3681AIJS-4.1-T1
Yes	Active High	SC70JW-8	UTXYY	AAT3681AIJS-4.2-T1
No	Active High	SC70JW-8	UEXYY	AAT3681AIJS-4.2-1-T1
Yes	Active Low	SC70JW-8	VSXYY	AAT3681AIJS-4.2-2-T1
No	Active High	SC70JW-8	A9XYY	AAT3681AIJS-4.2-4-T1
Yes	Active High	SC70JW-8	F2XYY	AAT3681AIJS-4.1-5-T1



Skyworks Green™ products are compliant with all applicable legislation and are halogen-free.

For additional information, refer to *Skyworks Definition of Green™*, document number SQ04-0074.

Package Information

SC70JW-8

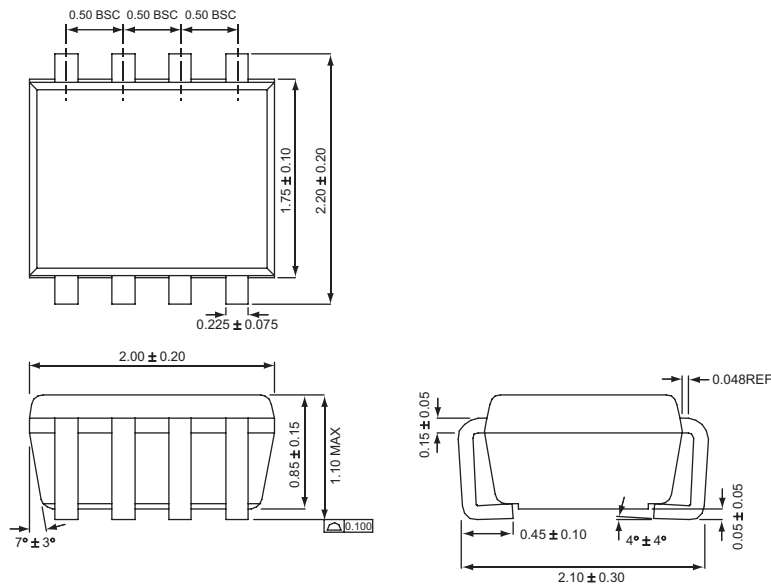

All dimensions in millimeters.

1. XYY = assembly and date code.
 2. Sample stock is generally held on part numbers listed in **BOLD**.

DATA SHEET
AAT368IA

500mA USB Port or AC Adapter Li-Ion/Polymer Battery Charger

Copyright © 2012 Skyworks Solutions, Inc. All Rights Reserved.

Information in this document is provided in connection with Skyworks Solutions, Inc. ("Skyworks") products or services. These materials, including the information contained herein, are provided by Skyworks as a service to its customers and may be used for informational purposes only by the customer. Skyworks assumes no responsibility for errors or omissions in these materials or the information contained herein. Skyworks may change its documentation, products, services, specifications or product descriptions at any time, without notice. Skyworks makes no commitment to update the materials or information and shall have no responsibility whatsoever for conflicts, incompatibilities, or other difficulties arising from any future changes.

No license, whether express, implied, by estoppel or otherwise, is granted to any intellectual property rights by this document. Skyworks assumes no liability for any materials, products or information provided hereunder, including the sale, distribution, reproduction or use of Skyworks products, information or materials, except as may be provided in Skyworks Terms and Conditions of Sale.

THE MATERIALS, PRODUCTS AND INFORMATION ARE PROVIDED "AS IS" WITHOUT WARRANTY OF ANY KIND, WHETHER EXPRESS, IMPLIED, STATUTORY, OR OTHERWISE, INCLUDING FITNESS FOR A PARTICULAR PURPOSE OR USE, MERCHANTABILITY, PERFORMANCE, QUALITY OR NON-INFRINGEMENT OF ANY INTELLECTUAL PROPERTY RIGHT; ALL SUCH WARRANTIES ARE HEREBY EXPRESSLY DISCLAIMED. SKYWORKS DOES NOT WARRANT THE ACCURACY OR COMPLETENESS OF THE INFORMATION, TEXT, GRAPHICS OR OTHER ITEMS CONTAINED WITHIN THESE MATERIALS. SKYWORKS SHALL NOT BE LIABLE FOR ANY DAMAGES, INCLUDING BUT NOT LIMITED TO ANY SPECIAL, INDIRECT, INCIDENTAL, STATUTORY, OR CONSEQUENTIAL DAMAGES, INCLUDING WITHOUT LIMITATION, LOST REVENUES OR LOST PROFITS THAT MAY RESULT FROM THE USE OF THE MATERIALS OR INFORMATION, WHETHER OR NOT THE RECIPIENT OF MATERIALS HAS BEEN ADVISED OF THE POSSIBILITY OF SUCH DAMAGE.

Skyworks products are not intended for use in medical, lifesaving or life-sustaining applications, or other equipment in which the failure of the Skyworks products could lead to personal injury, death, physical or environmental damage. Skyworks customers using or selling Skyworks products for use in such applications do so at their own risk and agree to fully indemnify Skyworks for any damages resulting from such improper use or sale.

Customers are responsible for their products and applications using Skyworks products, which may deviate from published specifications as a result of design defects, errors, or operation of products outside of published parameters or design specifications. Customers should include design and operating safeguards to minimize these and other risks. Skyworks assumes no liability for applications assistance, customer product design, or damage to any equipment resulting from the use of Skyworks products outside of stated published specifications or parameters.

Skyworks, the Skyworks symbol, and "Breakthrough Simplicity" are trademarks or registered trademarks of Skyworks Solutions, Inc., in the United States and other countries. Third-party brands and names are for identification purposes only, and are the property of their respective owners. Additional information, including relevant terms and conditions, posted at www.skyworksinc.com, are incorporated by reference.

Looking for pricing, stock, or lifecycle information?

Click below to explore more details on WIN SOURCE:

- ⊖ [View AAT3681AIJS-4.2-T1 on WIN SOURCE](#)
- ⊖ [Skyworks Solutions Inc. Information](#)

Optimize Your Supply Chain with WIN SOURCE Solutions

- ✓ Global Sourcing Solution
- ✓ Obsolete Management
- ✓ Cost Control Management
- ✓ Shortage Management
- ✓ Alternative Solution
- ✓ Excess Inventory Management