



**THE DATASHEET OF
XC95216-20PQG160I**





XC95216 In-System Programmable CPLD

DS068 (v5.0) May 17, 2013

Product Specification

Features

- 10 ns pin-to-pin logic delays on all pins
- f_{CNT} to 111 MHz
- 216 macrocells with 4,800 usable gates
- Up to 166 user I/O pins
- 5V in-system programmable
 - Endurance of 10,000 program/erase cycles
 - Program/erase over full commercial voltage and temperature range
- Enhanced pin-locking architecture
- Flexible 36V18 Function Block
 - 90 product terms drive any or all of 18 macrocells within Function Block
 - Global and product term clocks, output enables, set and reset signals
- Extensive IEEE Std 1149.1 boundary-scan (JTAG) support
- Programmable power reduction mode in each macrocell
- Slew rate control on individual outputs
- User programmable ground pin capability
- Extended pattern security features for design protection
- High-drive 24 mA outputs
- 3.3V or 5V I/O capability
- Advanced CMOS 5V FastFLASH™ technology
- Supports parallel programming of more than one XC9500 concurrently
- Available 160-pin PQFP, 352-pin BGA, and 208-pin HQFP packages (Note: 352-pin BGA packages are being discontinued for this device)

Description

The XC95216 is a high-performance CPLD providing advanced in-system programming and test capabilities for general purpose logic integration. It is comprised of eight 36V18 Function Blocks, providing 4,800 usable gates with propagation delays of 10 ns. See [Figure 2](#) for the architecture overview.

Power Management

Power dissipation can be reduced in the XC95216 by configuring macrocells to standard or low-power modes of operation. Unused macrocells are turned off to minimize power dissipation.

Operating current for each design can be approximated for specific operating conditions using the following equation:

$$I_{CC} \text{ (mA)} = MC_{HP} (1.7) + MC_{LP} (0.9) + MC (0.006 \text{ mA/MHz}) f$$

Where:

MC_{HP} = Macrocells in high-performance mode

MC_{LP} = Macrocells in low-power mode

MC = Total number of macrocells used

f = Clock frequency (MHz)

[Figure 1](#) shows a typical calculation for the XC95216 device.

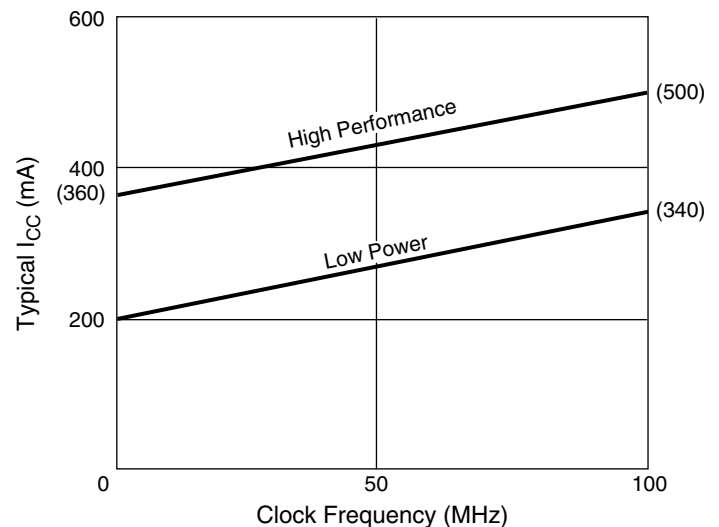

DS068_01_110101

Figure 1: Typical I_{CC} vs. Frequency for XC95216

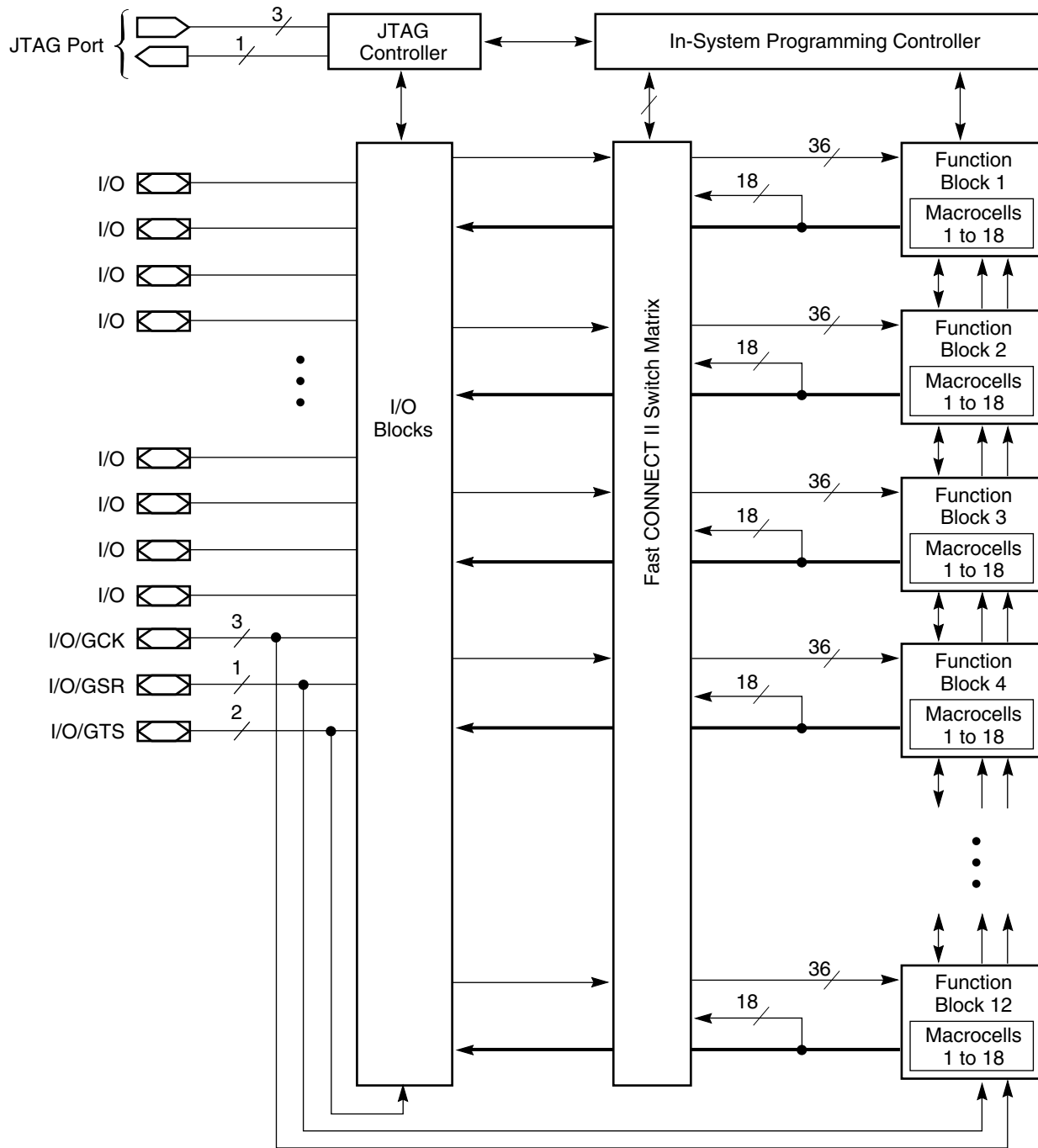

DS068_02_110101

Figure 2: XC95216 Architecture

Function block outputs (indicated by the bold line) drive the I/O blocks directly.

Absolute Maximum Ratings

Symbol	Description	Value	Units
V_{CC}	Supply voltage relative to GND	-0.5 to 7.0	V
V_{IN}	Input voltage relative to GND	-0.5 to $V_{CC} + 0.5$	V
V_{TS}	Voltage applied to 3-state output	-0.5 to $V_{CC} + 0.5$	V
T_{STG}	Storage temperature (ambient)	-65 to +150	°C
T_J	Junction temperature	+150	°C

Notes:

- Stresses beyond those listed under Absolute Maximum Ratings may cause permanent damage to the device. These are stress ratings only, and functional operation of the device at these or any other conditions beyond those listed under Operating Conditions is not implied. Exposure to Absolute Maximum Ratings conditions for extended periods of time may affect device reliability.

Recommended Operation Conditions

Symbol	Parameter		Min	Max	Units
V_{CCINT}	Supply voltage for internal logic and input buffers	Commercial $T_A = 0^\circ\text{C}$ to 70°C	4.75	5.25	V
		Industrial $T_A = -40^\circ\text{C}$ to $+85^\circ\text{C}$	4.5	5.5	
V_{CCIO}	Supply voltage for output drivers for 5V operation	Commercial $T_A = 0^\circ\text{C}$ to 70°C	4.75	5.25	V
		Industrial $T_A = -40^\circ\text{C}$ to $+85^\circ\text{C}$	4.5	5.5	
	Supply voltage for output drivers for 3.3V operation	3.0	3.6		
V_{IL}	Low-level input voltage		0	0.80	V
V_{IH}	High-level input voltage		2.0	$V_{CCINT} + 0.5$	V
V_O	Output voltage		0	V_{CCIO}	V

Quality and Reliability Characteristics

Symbol	Parameter	Min	Max	Units
T_{DR}	Data Retention	20	-	Years
N_{PE}	Program/Erase Cycles (Endurance)	10,000	-	Cycles

DC Characteristic Over Recommended Operating Conditions

Symbol	Parameter	Test Conditions	Min	Max	Units
V_{OH}	Output high voltage for 5V outputs	$I_{OH} = -4.0\text{ mA}$, $V_{CC} = \text{Min}$	2.4	-	V
	Output high voltage for 3.3V outputs	$I_{OH} = -3.2\text{ mA}$, $V_{CC} = \text{Min}$	2.4	-	V
V_{OL}	Output low voltage for 5V outputs	$I_{OL} = 24\text{ mA}$, $V_{CC} = \text{Min}$	-	0.5	V
	Output low voltage for 3.3V outputs	$I_{OL} = 10\text{ mA}$, $V_{CC} = \text{Min}$	-	0.4	V
I_{IL}	Input leakage current	$V_{CC} = \text{Max}$ $V_{IN} = \text{GND or } V_{CC}$	-	± 10	μA
I_{IH}	I/O high-Z leakage current	$V_{CC} = \text{Max}$ $V_{IN} = \text{GND or } V_{CC}$	-	± 10	μA
C_{IN}	I/O capacitance	$V_{IN} = \text{GND}$ $f = 1.0\text{ MHz}$	-	10	pF
I_{CC}	Operating supply current (low power mode, active)	$V_I = \text{GND}$, No load $f = 1.0\text{ MHz}$	200 (Typical)		mA

AC Characteristics

Symbol	Parameter	XC95216-10		XC95216-15		XC95216-20		Units
		Min	Max	Min	Max	Min	Max	
T_{PD}	I/O to output valid	-	10.0	-	15.0	-	20.0	ns
T_{SU}	I/O setup time before GCK	6.0	-	8.0	-	10.0	-	ns
T_H	I/O hold time after GCK	0	-	0	-	0	-	ns
T_{CO}	GCK to output valid	-	6.0	-	8.0	-	10.0	ns
$f_{CNT}^{(1)}$	16-bit counter frequency	111.1	-	95.2	-	83.3	-	MHz
$f_{SYSTEM}^{(2)}$	Multiple FB internal operating frequency	66.7	-	55.6	-	50.0	-	MHz
T_{PSU}	I/O setup time before p-term clock input	2.0	-	4.0	-	4.0	-	ns
T_{PH}	I/O hold time after p-term clock input	4.0	-	4.0	-	6.0	-	ns
T_{PCO}	P-term clock output valid	-	10.0	-	12.0	-	16.0	ns
T_{OE}	GTS to output valid	-	6.0	-	11.0	-	16.0	ns
T_{OD}	GTS to output disable	-	6.0	-	11.0	-	16.0	ns
T_{POE}	Product term OE to output enabled	-	10.0	-	14.0	-	18.0	ns
T_{POD}	Product term OE to output disabled	-	10.0	-	14.0	-	18.0	ns
T_{WLH}	GCK pulse width (High or Low)	4.5	-	5.5	-	5.5	-	ns
T_{APRPW}	Asynchronous preset/reset pulse width (High or Low)	7.5	-	8.0	-	8.0	-	ns

Notes:

- f_{CNT} is the fastest 16-bit counter frequency available, using the local feedback when applicable. f_{CNT} is also the Export Control Maximum flip-flop toggle rate, f_{TOG} .
- f_{SYSTEM} is the internal operating frequency for general purpose system designs spanning multiple FBs.



Output Type	VCCIO	VTEST	R1	R2	CL
	5.0V	5.0V	160Ω	120Ω	35 pF
	3.3V	3.3V	260Ω	360Ω	35 pF

DS067_03_110101

Figure 3: AC Load Circuit

Internal Timing Parameters

Symbol	Parameter	XC95216-10		XC95216-15		XC95216-20		Units
		Min	Max	Min	Max	Min	Max	
Buffer Delays								
T_{IN}	Input buffer delay	-	3.5	-	4.5	-	6.5	ns
T_{GCK}	GCK buffer delay	-	2.5	-	3.0	-	3.0	ns
T_{GSR}	GSR buffer delay	-	6.0	-	7.5	-	9.5	ns
T_{GTS}	GTS buffer delay	-	6.0	-	11.0	-	16.0	ns
T_{OUT}	Output buffer delay	-	3.0	-	4.5	-	6.5	ns
T_{EN}	Output buffer enable/disable delay	-	0	-	0	-	0	ns
Product Term Control Delays								
T_{PTCK}	Product term clock delay	-	3.0	-	2.5	-	2.5	ns
T_{PTSR}	Product term set/reset delay	-	2.5	-	3.0	-	3.0	ns
T_{PTTS}	Product term 3-state delay	-	3.5	-	5.0	-	5.0	ns
Internal Register and Combinatorial Delays								
T_{PDI}	Combinatorial logic propagation delay	-	1.0	-	3.0	-	4.0	ns
T_{SUI}	Register setup time	2.5	-	3.5	-	3.5	-	ns
T_{HI}	Register hold time	3.5	-	4.5	-	6.5	-	ns
T_{COI}	Register clock to output valid time	-	0.5	-	0.5	-	0.5	ns
T_{AOI}	Register async. S/R to output delay	-	7.0	-	8.0	-	8.0	ns
T_{RAI}	Register async. S/R recover before clock	10.0	-	10.0	-	10.0	-	ns
T_{LOGI}	Internal logic delay	-	2.5	-	3.0	-	3.0	ns
T_{LOGILP}	Internal low power logic delay	-	11.0	-	11.5	-	11.5	ns
Feedback Delays								
T_F	FastCONNECT feedback delay	-	9.5	-	11.0	-	13.0	ns
T_{LF}	Function block local feedback delay	-	3.5	-	3.5	-	5.0	ns
Time Adders								
$T_{PTA}^{(1)}$	Incremental product term allocator delay	-	1.0	-	1.0	-	1.5	ns
T_{SLEW}	Slew-rate limited delay	-	4.5	-	5.0	-	5.5	ns

Notes:

- T_{PTA} is multiplied by the span of the function as defined in the XC9500 family data sheet.

XC95216 I/O Pins

Function Block	Macro-cell	PQ160	HQ208	BG352 ⁽²⁾	BScan Order	Function Block	Macro-cell	PQ160	HQ208	BG352 ⁽²⁾	BScan Order
1	1	–	–	–	645	3	1	–	–	–	537
1	2	18	22	M25	642	3	2	32	43	AA26	534
1	3	19	23	M26	639	3	3	33 ^[1]	44 ^[1]	Y24 ^[1]	531
1	4	–	28	N26	636	3	4	–	39	U23	528
1	5	21	25	N25	633	3	5	34	45	AB25	525
1	6	22	30	P23	630	3	6	35 ^[1]	46 ^[1]	AA24 ^[1]	522
1	7	–	–	–	627	3	7	–	–	–	519
1	8	23	31	P24	624	3	8	36	47	Y23	516
1	9	24	32	R26	621	3	9	37	49	AA23	513
1	10	–	12	G26	618	3	10	–	67	AD18	510
1	11	25	33	R24	615	3	11	38	50	AB24	507
1	12	26	34	T26	612	3	12	39	51	AD25	504
1	13	–	–	–	609	3	13	–	–	–	501
1	14	27	35	T25	606	3	14	42 ^[1]	55 ^[1]	AD23 ^[1]	498
1	15	28	36	T23	603	3	15	43	56	AF24	495
1	16	29	37	V26	600	3	16	–	80	AE12	492
1	17	30	38	U24	597	3	17	44	57	AE23	489
1	18	–	–	–	594	3	18	–	–	–	486
2	1	–	–	–	591	4	1	–	–	–	483
2	2	6 ^[1]	7 ^[1]	E25 ^[1]	588	4	2	152	198	D18	480
2	3	7	8	G24	585	4	3	153	199	A21	477
2	4	–	29	P25	582	4	4	–	196	B19	474
2	5	8 ^[1]	9 ^[1]	F26 ^[1]	579	4	5	154	200	B20	471
2	6	9	10	H23	576	4	6	155	201	C20	468
2	7	–	–	–	573	4	7	–	–	–	465
2	8	11	15	K23	570	4	8	156	202	B22	462
2	9	12	16	K24	567	4	9	158	205	B24	459
2	10	–	–	–	564	4	10	–	–	–	456
2	11	13	17	J25	561	4	11	159 ^[1]	206 ^[1]	C23 ^[1]	453
2	12	14	18	L24	558	4	12	2 ^[1]	3 ^[1]	E23 ^[1]	450
2	13	–	–	–	555	4	13	–	–	–	447
2	14	15	19	K25	552	4	14	3	4	C26	444
2	15	16	20	L26	549	4	15	4 ^[1]	5 ^[1]	E24 ^[1]	441
2	16	–	14	H25	546	4	16	–	203	D20	438
2	17	17	21	M24	543	4	17	5	6	F24	435
2	18	–	–	–	540	4	18	–	–	–	432

Notes:

1. Global control pin.
2. 352-pin BGA package is being discontinued for the XC95216. See [XCN07010](#) for details.

XC95216 I/O Pins (Continued)

Function Block	Macro-cell	PQ160	HQ208	BG352 ⁽²⁾	BScan Order	Function Block	Macro-cell	PQ160	HQ208	BG352 ⁽²⁾	BScan Order
5	1	–	–	–	429	7	1	–	–	–	321
5	2	45	58	AE22	426	7	2	58	76	AE13	318
5	3	47	60	AE21	423	7	3	59	77	AC13	315
5	4	–	41	W25	420	7	4	–	54	AE24	312
5	5	48	61	AF21	417	7	5	60	78	AD13	309
5	6	49	63	AD19	414	7	6	62	82	AD12	306
5	7	–	–	–	411	7	7	–	–	–	303
5	8	50	64	AE20	408	7	8	63	83	AC12	300
5	9	52	70	AF18	405	7	9	64	84	AF11	297
5	10	–	109	AD1	402	7	10	–	91	AD8	294
5	11	53	71	AE17	399	7	11	65	85	AE11	291
5	12	54	72	AE16	396	7	12	66	86	AE9	288
5	13	–	–	–	393	7	13	–	–	–	285
5	14	55	73	AF16	390	7	14	67	87	AD9	282
5	15	56	74	AE14	387	7	15	68	88	AC10	279
5	16	–	40	Y26	384	7	16	–	48	AC26	276
5	17	57	75	AF14	381	7	17	69	89	AF7	273
5	18	–	–	–	378	7	18	–	–	–	270
6	1	–	–	–	375	8	1	–	–	–	267
6	2	140	180	A12	372	8	2	126	162	B5	264
6	3	142	182	A13	369	8	3	128	164	B6	261
6	4	–	208	D22	366	8	4	–	143	J1	258
6	5	143	185	C14	363	8	5	129	166	D8	255
6	6	144	186	A15	360	8	6	130	167	B7	252
6	7	–	–	–	357	8	7	–	–	–	249
6	8	145	187	B15	354	8	8	131	170	C10	246
6	9	146	188	C15	351	8	9	132	171	B9	243
6	10	–	183	B14	348	8	10	–	195	A20	240
6	11	147	191	A16	345	8	11	133	173	A9	237
6	12	148	192	C16	342	8	12	134	174	D11	234
6	13	–	–	–	339	8	13	–	–	–	231
6	14	149	193	C17	336	8	14	135	175	B11	228
6	15	150	194	B18	333	8	15	138	178	C12	225
6	16	–	169	D9	330	8	16	–	189	D15	222
6	17	151	197	C19	327	8	17	139	179	B12	219
6	18	–	–	–	324	8	18	–	–	–	216

Notes:

1. Global control pin.
2. 352-pin BGA package is being discontinued for the XC95216. See [XCN07010](#) for details.

XC95216 I/O Pins (Continued)

Function Block	Macro-cell	PQ160	HQ208	BG352 ⁽²⁾	BScan Order	Function Block	Macro-cell	PQ160	HQ208	BG352 ⁽²⁾	BScan Order
9	1	–	–	–	213	11	1	–	–	–	105
9	2	72	95	AD7	210	11	2	87	115	Y1	102
9	3	74	97	AE5	207	11	3	88	116	V4	99
9	4	–	101	AD4	204	11	4	–	119	U4	96
9	5	76	99	AC7	201	11	5	89	117	V3	93
9	6	77	100	AE3	198	11	6	90	118	W2	90
9	7	–	–	–	195	11	7	–	–	–	87
9	8	78	102	AC5	192	11	8	91	121	V2	84
9	9	79	103	AD3	189	11	9	92	122	U2	81
9	10	–	90	AE8	186	11	10	–	107	AC3	78
9	11	82	110	AA4	183	11	11	93	123	T2	75
9	12	83	111	AB2	180	11	12	95	125	R4	72
9	13	–	–	–	177	11	13	–	–	–	69
9	14	84	112	AC1	174	11	14	96	126	R3	66
9	15	85	113	AA2	171	11	15	97	127	R2	63
9	16	–	62	AC19	168	11	16	–	120	U3	60
9	17	86	114	AA1	165	11	17	98	128	R1	57
9	18	–	–	–	162	11	18	–	–	–	54
10	1	–	–	–	159	12	1	–	–	–	51
10	2	113	147	H3	156	12	2	101	131	P1	48
10	3	114	148	J4	153	12	3	102	133	N2	45
10	4	–	144	K3	150	12	4	–	106	AD2	42
10	5	115	149	G2	147	12	5	103	134	N4	39
10	6	116	150	G3	144	12	6	104	135	N3	36
10	7	–	–	–	141	12	7	–	–	–	33
10	8	117	152	E2	138	12	8	105	136	M1	30
10	9	118	154	D2	135	12	9	106	137	M3	27
10	10	–	168	A7	132	12	10	–	151	F2	24
10	11	119	155	F4	129	12	11	107	138	M4	21
10	12	122	158	B3	126	12	12	108	139	L1	18
10	13	–	–	–	123	12	13	–	–	–	15
10	14	123	159	A3	120	12	14	109	140	L2	12
10	15	124	160	D6	117	12	15	111	145	G1	9
10	16	–	165	A6	114	12	16	–	142	L3	6
10	17	125	161	C6	111	12	17	112	146	H2	3
10	18	–	–	–	108	12	18	–	–	–	0

Notes:

1. Global control pin.
2. 352-pin BGA package is being discontinued for the XC95216. See [XCN07010](#) for details.

XC95216 Global, JTAG and Power Pins

Pin Type	PQ160	HQ208	BG352
I/O/GCK1	33	44	Y24
I/O/GCK2	35	46	AA24
I/O/GCK3	42	55	AD23
I/O/GTS1	6	7	E25
I/O/GTS2	8	9	F26
I/O/GTS3	2	3	E23
I/O/GTS4	4	5	E24
I/O/GSR	159	206	C23
TCK	75	98	AD6
TDI	71	94	AF6
TDO	136	176	D12
TMS	73	96	AE6
V _{CCINT} 5V	10,46,94,157	11, 59, 124, 153, 204	H24, AF23, T1, G4, C22
V _{CCIO} 3.3V/5V	1,41,61,81,121,141	1, 26, 53, 65, 79, 92, 105, 132, 157, 172, 181, 184	A10, A17, B2, B25, D7, D13, D19, G23, H4, K1, K26, N23, P4, U1, U26, W23, Y4, AC8, AC14, AC20, AE25, AF10, AF17
GND	20, 31, 40, 51, 70, 80, 99, 100, 110, 120, 127, 137, 160	2, 13, 24, 27, 42, 52, 66, 68, 69, 81, 93, 104, 108, 129, 130, 141, 156, 163, 177, 190, 207	A1, A2, A5, A8, A14, A19, A22, A25, A26, B1, B26, C7, E1, E26, H1, H26, N1, P3, P26, V23, W1, W26, AB1, AB4, AB26, AC9, AC17, AE1, AE26, AF1, AF2, AF5, AF8, AF13, AF19, AF20, AF22, AF25, AF26
No Connects	–	–	A4, A11, A18, A23, A24, B4, B8, B10, B13, B16, B17, B21, B23, C1, C2, C3, C4, C5, C8, C9, C11, C13, C18, C21, C24, C25, D1, D3, D4, D5, D10, D14, D16, D17, D21, D23, D24, D25, D26, E3, E4, F1, F3, F23, F25, G25, J2, J3, J23, J24, J26, K2, K4, L4, L23, L25, M2, M23, N24, P2, R23, R25, T3, T4, T24, U25, V1, V24, V25, W3, W4, W24, Y2, Y3, Y25, AA3, AA25, AB3, AB23, AC2, AC4, AC6, AC11, AC15, AC16, AC18, AC21, AC22, AC23, AC24, AC25, AD5, AD10, AD11, AD14, AD15, AD16, AD17, AD20, AD21, AD22, AD24, AD26, AE2, AE4, AE7, AE10, AE15, AE18, AE19, AF3, AF4, AF9, AF12, AF15

Device Part Marking and Ordering Combination Information

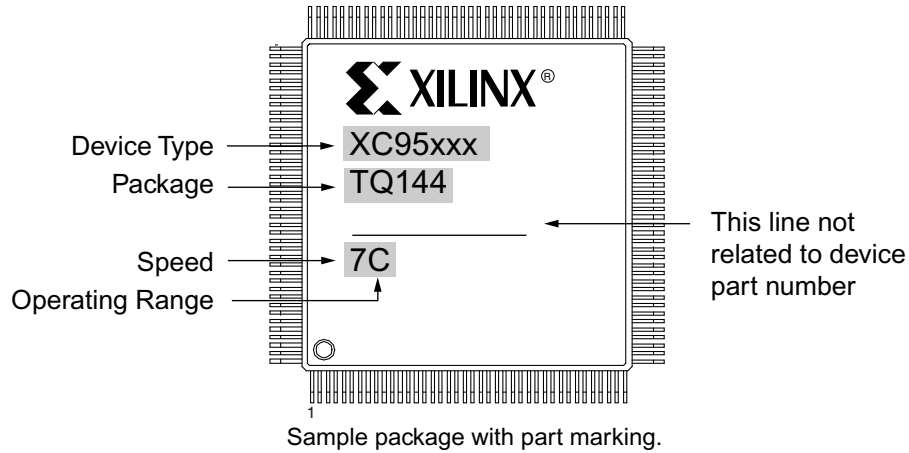

Device Ordering and Part Marking Number	Speed (pin-to-pin delay)	Pkg. Symbol	No. of Pins	Package Type	Operating Range ⁽¹⁾
XC95216-10PQ160C	10 ns	PQ160	160-pin	Plastic Quad Flat Pack (PQFP)	C
XC95216-10PQG160C	10 ns	PQG160	160-pin	Plastic Quad Flat Pack (PQFP); Pb-Free	C
XC95216-10HQ208C	10 ns	HQ208	208-pin	Heat Sink Quad Flat Pack (HQFP)	C
XC95216-10BG352C	10 ns	BG352	352-ball	Ball Grid Array (BGA)	C
XC95216-10PQ160I	10 ns	PQ160	160-pin	Plastic Quad Flat Pack (PQFP)	I
XC95216-10PQG160I	10 ns	PQG160	160-pin	Plastic Quad Flat Pack (PQFP); Pb-Free	I
XC95216-10HQ208I	10 ns	HQ208	208-pin	Heat Sink Quad Flat Pack (HQFP)	I
XC95216-10BG352I	10 ns	BG352	352-ball	Ball Grid Array (BGA)	I
XC95216-15PQ160C	15 ns	PQ160	160-pin	Plastic Quad Flat Pack (PQFP)	C
XC95216-15PQG160C	15 ns	PQG160	160-pin	Plastic Quad Flat Pack (PQFP); Pb-Free	C
XC95216-15HQ208C	15 ns	HQ208	208-pin	Heat Sink Quad Flat Pack (HQFP)	C
XC95216-10BG352C	15 ns	BG352	352-ball	Ball Grid Array (BGA)	C
XC95216-15PQ160I	15 ns	PQ160	160-pin	Plastic Quad Flat Pack (PQFP)	I
XC95216-15PQG160I	15 ns	PQG160	160-pin	Plastic Quad Flat Pack (PQFP); Pb-Free	I
XC95216-15HQ208I	15 ns	HQ208	208-pin	Heat Sink Quad Flat Pack (HQFP)	I
XC95216-15BG352I	15 ns	BG352	352-ball	Ball Grid Array (BGA)	I
XC95216-20PQ160C	20 ns	PQ160	160-pin	Plastic Quad Flat Pack (PQFP)	C
XC95216-20PQG160C	20 ns	PQG160	160-pin	Plastic Quad Flat Pack (PQFP); Pb-Free	C
XC95216-20HQ208C	20 ns	HQ208	208-pin	Heat Sink Quad Flat Pack (HQFP)	C
XC95216-20BG352C	20 ns	BG352	352-ball	Ball Grid Array (BGA)	C
XC95216-20PQ160I	20 ns	PQ160	160-pin	Plastic Quad Flat Pack (PQFP)	I
XC95216-20PQG160I	20 ns	PQG160	160-pin	Plastic Quad Flat Pack (PQFP); Pb-Free	I
XC95216-20HQ208I	20 ns	HQ208	208-pin	Heat Sink Quad Flat Pack (HQFP)	I
XC95216-20BG352I	20 ns	BG352	352-ball	Ball Grid Array (BGA)	I

Notes:

1. C = Commercial: $T_A = 0^\circ$ to $+70^\circ\text{C}$; I = Industrial: $T_A = -40^\circ$ to $+85^\circ\text{C}$
2. 352-pin BGA package is being discontinued for the XC95216. See [XC95216](#) for details.

Warranty Disclaimer

THESE PRODUCTS ARE SUBJECT TO THE TERMS OF THE XILINX LIMITED WARRANTY WHICH CAN BE VIEWED AT <http://www.xilinx.com/warranty.htm>. THIS LIMITED WARRANTY DOES NOT EXTEND TO ANY USE OF THE PRODUCTS IN AN APPLICATION OR ENVIRONMENT THAT IS NOT WITHIN THE SPECIFICATIONS STATED ON THE THEN-CURRENT XILINX DATA SHEET FOR THE PRODUCTS. PRODUCTS ARE NOT DESIGNED TO BE FAIL-SAFE AND ARE NOT WARRANTED FOR USE IN APPLICATIONS THAT POSE A RISK OF PHYSICAL HARM OR LOSS OF LIFE. USE OF PRODUCTS IN SUCH APPLICATIONS IS FULLY AT THE RISK OF CUSTOMER SUBJECT TO APPLICABLE LAWS AND REGULATIONS.

Revision History

The following table shows the revision history for this document.

Date	Version	Revision
12/04/1998	3.0	Update AC characteristics and internal parameters.
08/21/2001	3.1	Added Note 1 to page 6.
06/18/2003	4.0	Updated format.
08/21/2003	4.1	Updated Package Device Marking Pin 1 orientation.
04/15/2005	4.2	Added asynchronous preset/reset pulse width specification (T_{APRPW})
04/03/2006	4.3	Added Warranty Disclaimer. Added Pb-Free package ordering information.
06/25/2007	4.4	Discontinuance of BG352 and BGG252 packages.
05/17/2013	5.0	The products listed in this data sheet are obsolete. See XCN11010 for further information. Removed note added in v4.4 about the 352-pin BGA packages. The XCN07010 covered this discontinuation.

Looking for pricing, stock, or lifecycle information?

Click below to explore more details on WIN SOURCE:

 [View XC95216-20PQG160I on WIN SOURCE](#)

 [Xilinx Inc. Information](#)

Optimize Your Supply Chain with WIN SOURCE Solutions

-  Global Sourcing Solution
-  Obsolete Management
-  Cost Control Management
-  Shortage Management
-  Alternative Solution
-  Excess Inventory Management