

Four-Channel Charge Pump LED Driver

General Description

The AAT3195 is a charge-pump based, current-sink white LED driver capable of driving one to four LEDs up to 30mA, each. It automatically switches between 1x mode and 2x mode to maintain the highest efficiency and optimal LED current accuracy and matching.

The AAT3195 charge pump's 1x mode (bypass mode) has very low resistance allowing LED current regulation to be maintained with input supply voltage approaching the LED forward voltage. The AAT3195 incorporates an internal R_{SET} and is available in a thermally enhanced, Pb-free 2x2.2mm 10-lead SC70JW-10 package.

Features

- Drives up to 4 LEDs at up to 30mA, each
- Automatic Switching Between 1x and 2x Modes
- 1MHz Switching Frequency
- Linear LED Output Current Control
 - Single-wire, S²Cwire™ Interface
 - AAT3195-1: 30mA, 32-step
 - AAT3195-2: 20mA, 32-step
 - ON/OFF or PWM Interface
 - AAT3195-3
- ±10% LED Output Current Accuracy
- 3% LED Output Current Matching
- Low-current Shutdown Mode
- Built-in Thermal Protection
- Automatic Soft-start
- 2x2.2mm SC70JW-10 Package

Applications

- Cordless Phone Handsets
- Digital Cameras
- Mobile Phone Handsets
- MP3 and PMP Players

Typical Application

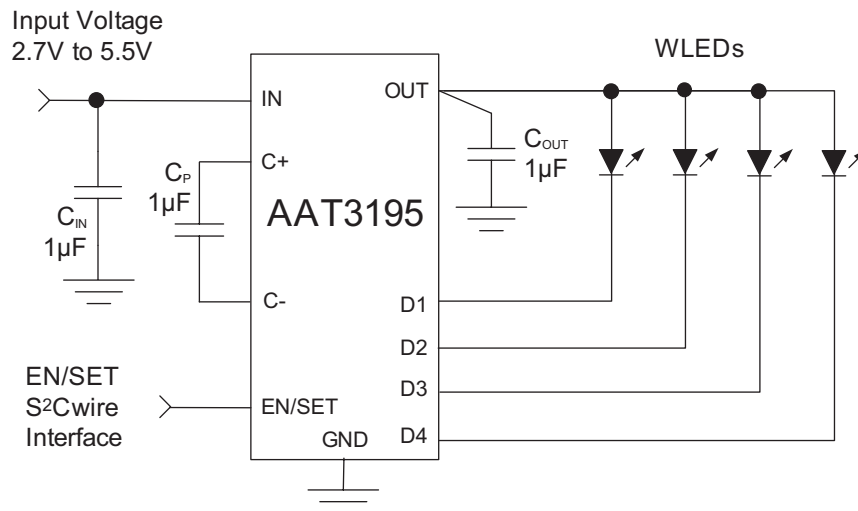

AAT3195**Four-Channel Charge Pump LED Driver****Pin Descriptions**

Pin #	Symbol	Description
1	D2	LED2 Current Sink Input. D2 is the input of LED2 current sink. Connect LED2's anode to OUT and its cathode to D2.
2	D1	LED1 Current Sink Input. D1 is the input of LED1 current sink. Connect LED1's anode to OUT and its cathode to D1.
3	OUT	Charge Pump Output. OUT is the output of the charge pump. Bypass OUT to AGND with a 1 μ F or larger ceramic capacitor.
4	C+	Charge Pump Capacitor Positive Node. Connect a 1 μ F ceramic capacitor between C+ and C-.
5	IN	Power source input. Connect IN to the power source, typically the battery. Bypass IN to AGND with a 1 μ F or larger ceramic capacitor.
6	EN/SET (AAT3195-1/-2)	LED Enable and serial control input. EN/SET is the ON/OFF control for the LED and the S ² Cwire digital input for the AAT3195-1/-2 to control serially the LED brightness according to the maximum current set by R _{SET} .
	EN/PWM (AAT3195-3)	LED ON/OFF and PWM control input. This logic input controls the LED outputs for the AAT3195-3. Alternatively, a PWM signal from a GPIO or an equivalent signal from a separate controller can be used to control LED output current linearly. A PWM signal, ranging from 10% to 100% duty cycle, controls the LED current linearly between ZS and FS.
7	C-	Charge Pump Capacitor Negative Node.
8	AGND	Analog Ground. Connect this pin to the system's analog ground plane.
9	D4	LED4 Current Sink Input. D4 is the input of LED4 current sink. Connect LED4's anode to OUT and its cathode to D4.
10	D3	LED3 Current Sink Input. D3 is the input of LED3 current sink. Connect LED3's anode to OUT and its cathode to D3.

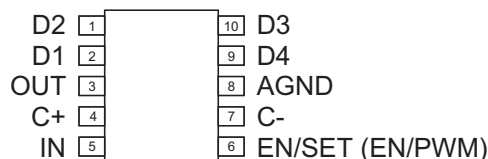
Pin Configuration**SC70JW-10
(Top View)**

AAT3195**Four-Channel Charge Pump LED Driver****Part Number Descriptions**

Part Number	Interface	Current Control, Inverting	Full Scale Current
AAT3195IJQ-1	S ² Cwire	32-step	30mA
AAT3195IJQ-2	S ² Cwire	32-step	20mA
AAT3195IJQ-3	PWM	Linear	30mA

Absolute Maximum Ratings¹

Symbol	Description	Value	Units
$V_{IN}, V_{C+}, V_{C-}, V_{OUT}, V_{Dx}$	IN, C+, C-, OUT, D1, D2, D3, and D4 Pin Voltages to AGND	-0.3 to 6.0	V
$V_{EN/SET}, V_{EN/PWM}$	EN/SET or EN/PWM Pin Voltage to AGND	-0.3 to $V_{IN} + 0.3$	V
T_J	Operating Junction Temperature Range	-40 to 150	°C
T_{LEAD}	Maximum Soldering Temperature (at leads, 10 sec)	300	°C

Thermal Information²

Symbol	Description	Value	Units
P_D	Maximum Power Dissipation ³	625	mW
Θ_{JA}	Maximum Thermal Resistance	160	°C/W

1. Stresses above those listed in Absolute Maximum Ratings may cause permanent damage to the device. Functional operation at conditions other than the operating conditions specified is not implied. Only one Absolute Maximum Rating should be applied at any one time.
2. Mounted on an FR4 circuit board.
3. Derate 6.25mW/°C above 40°C ambient temperature.

Four-Channel Charge Pump LED Driver

Electrical Characteristics

IN = EN = 3.6V; C_{IN} = 1μF; C_{OUT} = 1μF; C_{CP} = 1μF; T_A = -40°C to 85°C unless otherwise noted. Typical values are at T_A = 25°C.

Symbol	Description	Conditions	Min	Typ	Max	Units
AAT3195-1/-2/-3 Input Power Supply						
IN	Input Voltage Range		2.7		5.5	V
I _{IN}	Input Operating Current	EN/SET or EN/PWM = IN; VD1 = VD2 = VD3 = VD4 = IN, excluding ID1-ID4			0.6	mA
		EN/SET or EN/PWM = IN; ID1 = ID2 = ID3 = ID4 = FS, excluding ID1-ID4; V _{IN} - V _F = 1.5V			3.5	mA
		Operating, ID1 = ID2 = ID3 = ID4 = FS; D1, D2, D3 and D4 = OPEN			7	mA
I _{IN(SHDN)}	Input Shutdown Current	IN = 5.5V; EN/SET or EN/PWM = GND			1	μA
Charge Pump Section						
I _{OUT}	Maximum Output Current			150		mA
f _{OSC}	Charge Pump Oscillator Frequency		0.65	0.9	1.15	MHz
V _{IN(TH)}	Charge Pump Mode Hysteresis (AAT3195-1 only)	ID1 = ID2 = ID3 = ID4 = 30mA		225		mV
	Charge Pump Mode Hysteresis (AAT3195-2 only)	ID1 = ID2 = ID3 = ID4 = 20mA		150		mV
t _{OUT}	Output Start-Up Time	EN/SET or EN/PWM ≥ V _{ENH}		150		μs
AAT3195-1/-2/-3: LED Current Sink Outputs						
I _{D(MAX)}	D1 - D4 Current Accuracy (AAT3195-1 only)	DATA = 1; V _{IN} - V _F = 1.5V	27	30	33	mA
	D1 - D4 Current Accuracy (AAT3195-2 only)	DATA = 1; V _{IN} - V _F = 1.5V	18	20	22	mA
ΔI _{D(MAX)}	D1 - D4 Current Matching	DATA = 1; V _{IN} - V _F = 1.5V		±3		%
I _{D(DATA30)}	D1 - D4 Current Accuracy (AAT3195-1 only)	DATA = 30; V _{IN} - V _F = 1.5V	1.672	1.9	2.128	mA
	D1 - D4 Current Accuracy (AAT3195-2 only)	DATA = 30; V _{IN} - V _F = 1.5V	1.144	1.3	1.456	mA
I _{D(10%)}	D1 - D4 Current Accuracy (AAT3195-3 only)	DC = 10%; f _{PWM} = 10kHz; V _{IN} - V _F = 1.5V		2.4		mA
V _{D(TH)}	D1- D4 Charge Pump Mode Transition Threshold (AAT3195-1 only)	ID1 = ID2 = ID3 = ID4 = 30mA		250		mV
	D1- D4 Charge Pump Mode Transition Threshold (AAT3195-3 only)	ID1 = ID2 = ID3 = ID4 = 20mA		170		mV

Four-Channel Charge Pump LED Driver**Electrical Characteristics**

IN = EN = 3.6V; C_{IN} = 1 μF; C_{OUT} = 1μF; C_{CP} = 1μF; T_A = -40°C to 85°C unless otherwise noted. Typical values are at T_A = 25°C.

Symbol	Description	Conditions	Min	Typ	Max	Units
AAT3195-1/-2: EN/SET and S²Cwire Control						
V _{EN(H)}	EN Input High Threshold Voltage		1.4			V
V _{EN(L)}	EN Input Low Threshold Voltage				0.4	V
I _{EN(LKG)}	EN Input Leakage Current	EN/SET ≥ V _{EN(H)}	-1		1	μA
t _{EN/SET(OFF)}	EN/SET Input OFF Timeout				500	μs
t _{EN/SET(LAT)}	EN/SET Input Latch Timeout				500	μs
t _{EN/SET(LOW)}	EN/SET Input LOW Time		0.3		75	μs
t _{ENSET(H-MIN)}	EN/SET Minimum High Time			50		ns
t _{ENSET(H-MAX)}	EN/SET Maximum High Time				75	μs
AAT3195-3: EN/PWM Current Control						
V _{EN(H)}	EN/PWM Input High Threshold Voltage		1.4			V
V _{EN(L)}	EN/PWM Input Low Threshold Voltage				0.4	V
I _{EN(LKG)}	EN/PWM Input Leakage Current	EN/PWM = IN = 5V	-1		1	μA
t _{PWM(ON)}	PWM Control Turn-On Delay			2		μs
t _{EN/PWM}	EN/PWM Input OFF Timeout		0.15		1	ms
f _{PWM}	PWM Control Frequency	Duty Cycle = 80%			50	kHz

AAT3195

Four-Channel Charge Pump LED Driver

Typical Characteristics

Quiescent Current vs. Input Voltage

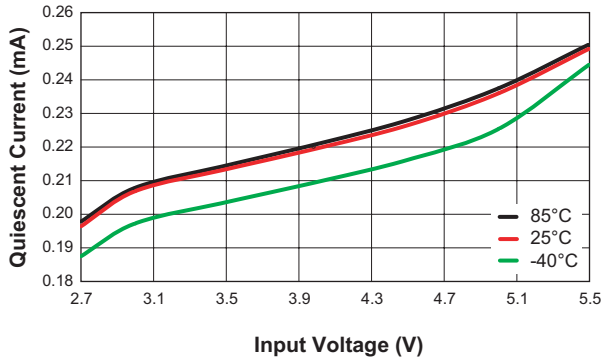

No Load Operating Current vs. Input Voltage

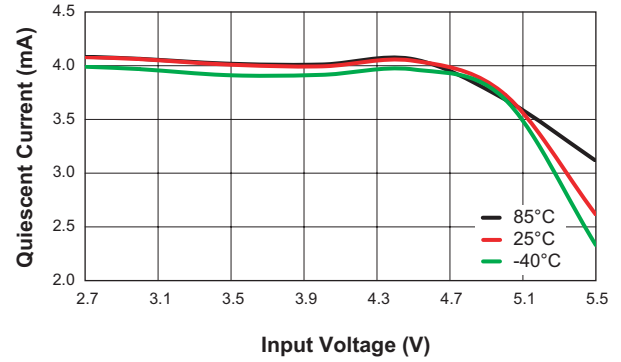

AAT3195-1 Efficiency vs. Input Voltage
($I_{LED} = 30mA$; $V_F = 4V$)

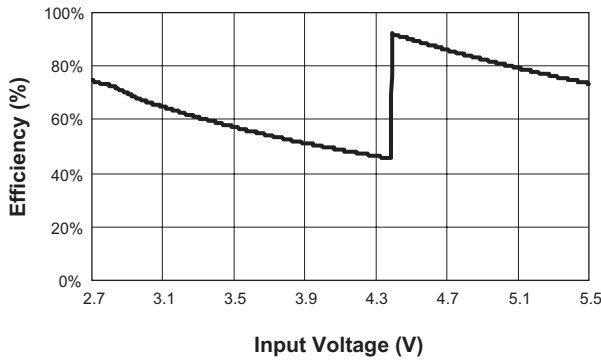

AAT3195-1 Current Matching vs. Temperature
($V_{IN} = 3.6V$)

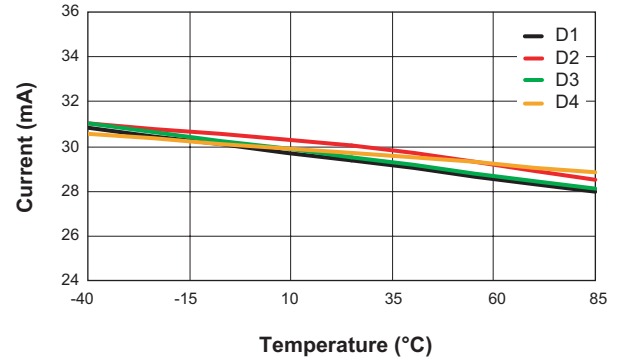

AAT3195-2 Efficiency vs. Input Voltage
($I_{LED} = 20mA$; $V_F = 3.6V$)

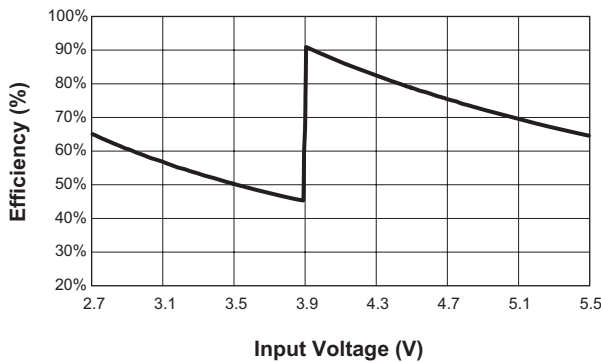

AAT3195-2 Current Matching vs. Temperature

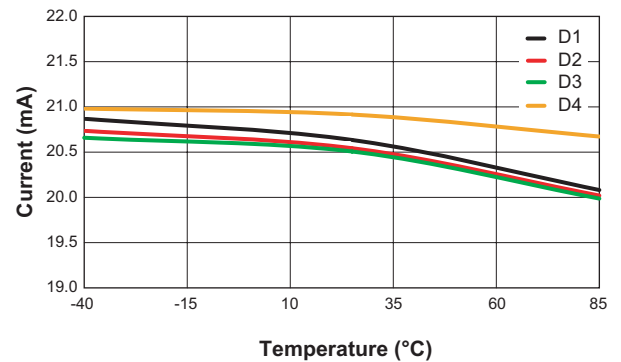

AAT3195

Four-Channel Charge Pump LED Driver

Typical Characteristics

Turn On to 1X Mode
($V_{IN} = 4.2V$; 20.5mA/ch)

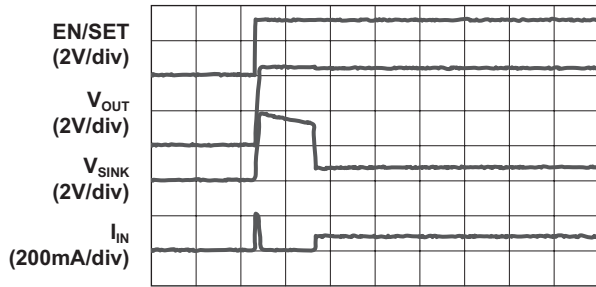

Time (200 μ s/div)

Turn On to 2X Mode
($V_{IN} = 3.6V$; 20.5mA/ch)

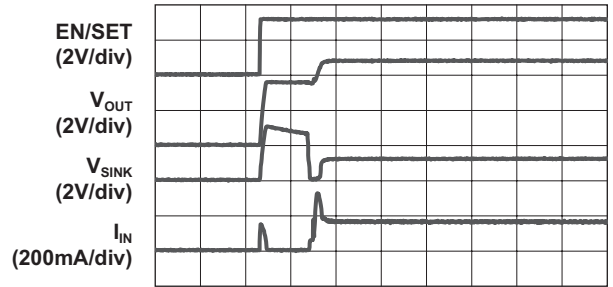

Time (200 μ s/div)

Turn Off from 2X Mode
(20.5mA/ch)

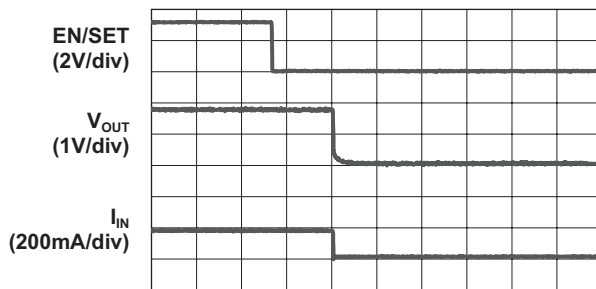

Time (200 μ s/div)

Shutdown Current vs. Temperature

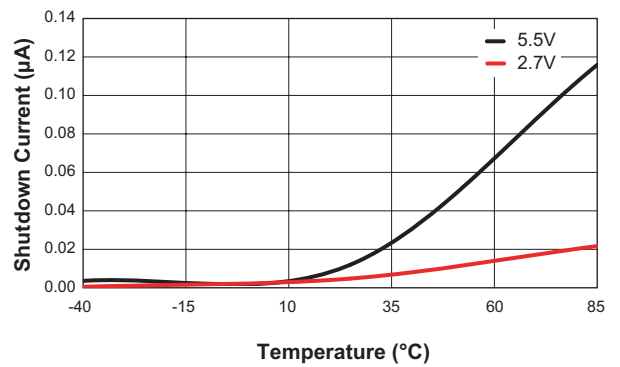

EN Input Low Threshold Voltage vs. Input Voltage

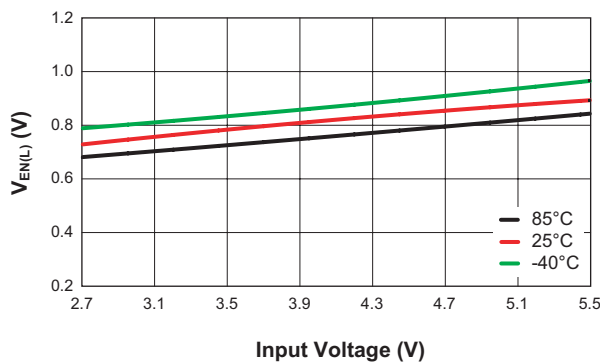

EN Input High Threshold Voltage vs. Input Voltage

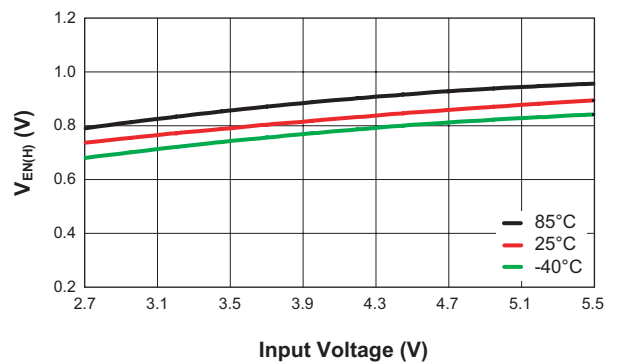

AAT3195

Four-Channel Charge Pump LED Driver

Typical Characteristics

EN/SET Input OFF Timeout vs. Input Voltage

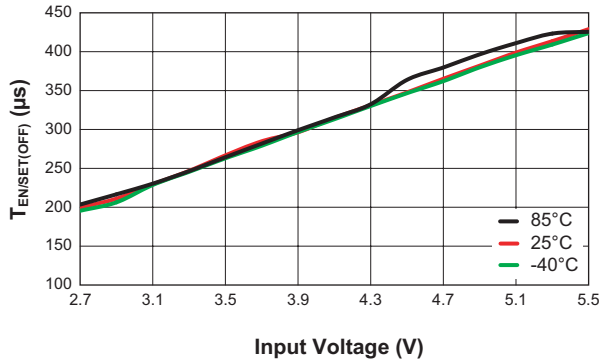

EN/SET Input Latch Timeout vs. Input Voltage

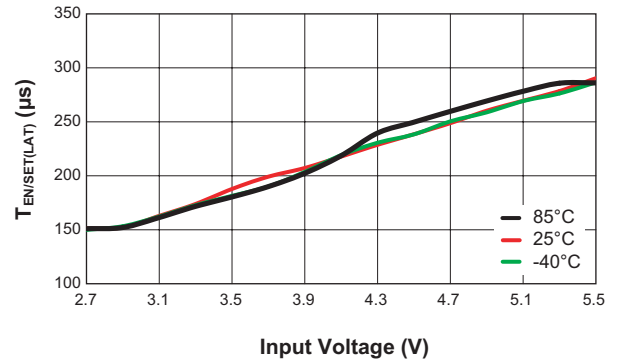

Transition of LED Current (1.3mA to 20.5mA)

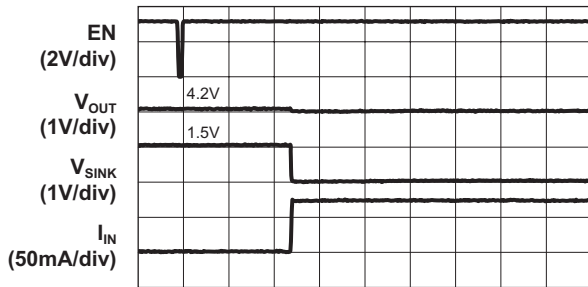

Time (100µs/div)

Transition of LED Current (20.5mA to 1.3mA)

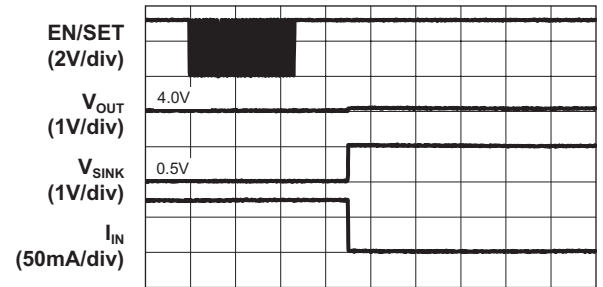

Time (100µs/div)

AAT3195-1 Output Ripple Waveform (V_{IN} = 3.6V; 2X Mode; 30mA Load)

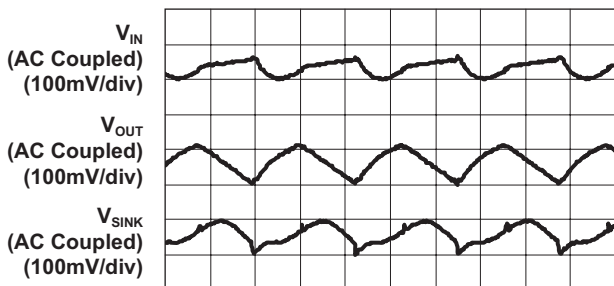

Time (500ns/div)

AAT3195-2 Output Ripple Waveform (V_{IN} = 3.6V; 2X Mode; 20.5mA Load)

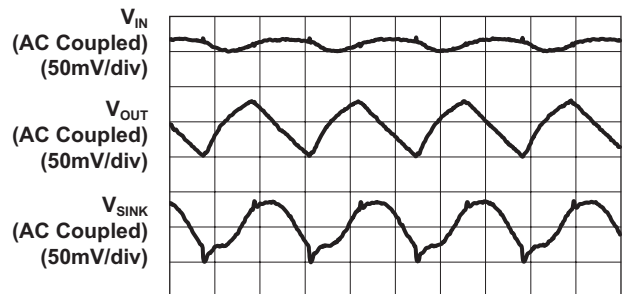

Time (500ns/div)

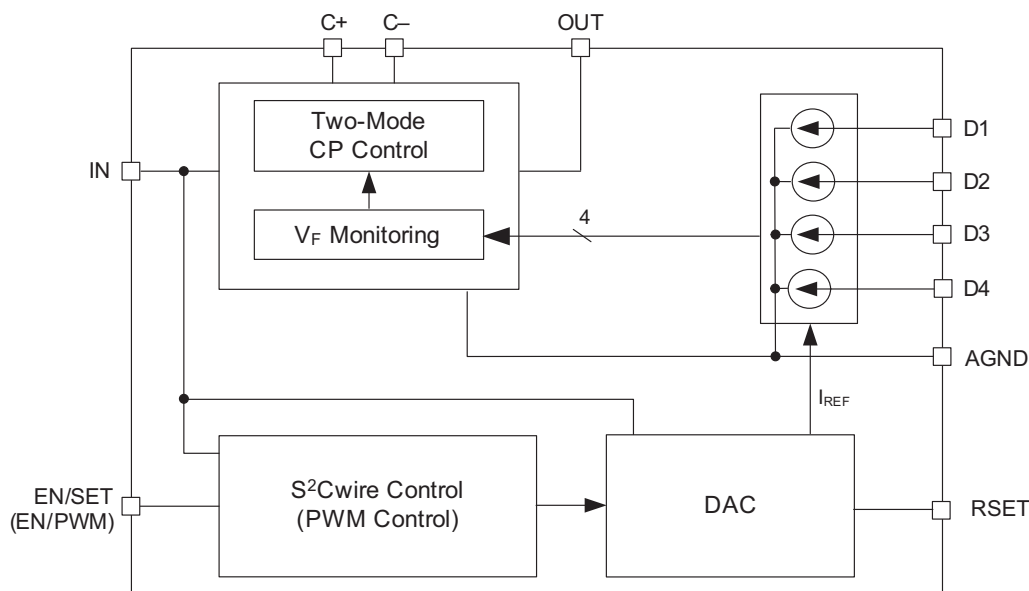
Functional Block Diagram**Functional Description**

The AAT3195 charge-pump solution is designed to drive up to four white LEDs. The charge pump operates from a 2.7V to 5.5V power source and converts it to voltage levels necessary to drive the LEDs. LED current is individually controlled through integrated current sinks powered from the output of the charge pump. Low 1x charge-pump output resistance and low-drop voltage current sinks allow the charge pump to stay in 1x mode with an input voltage as low as 3.75V and LED forward voltages as high as 3.5V. Once in 2x mode, the charge pump monitors the input supply voltage and automatically switches back to 1x mode when there is sufficient input voltage.

The AAT3195 requires only three external components: one 1 μ F ceramic capacitor for the charge pump flying capacitor (C_p), one 1 μ F ceramic capacitor at the IN pin (C_{IN}), and one 1 μ F ceramic capacitor at the OUT pin (C_{OUT}). The four constant-current outputs of the AAT3195-1 (D1 to D4) can drive four individual LEDs with a maximum current of 30mA each or, in the case of the AAT3195-2, with a maximum current up to 20mA. Skyworks' single-wire S²Cwire serial interface enables the AAT3195-1/-2 and changes the current sink current in 32 steps through the EN/SET pin. The AAT3195-3 uses an external PWM signal to enable the IC and control the brightness of the LEDs.

S²Cwire Interface (AAT3195-1/-2 Only)

The LED output current of the AAT3195-1/-2 is controlled by Skyworks' S²Cwire serial interface. Since the LED current is programmable, no PWM or additional control circuitry is needed to control LED brightness. This feature greatly reduces the burden on a microcontroller or system IC to manage LED or display brightness, allowing the user to "set it and forget it." With its high-speed serial interface (1MHz data rate), the LED current can be changed quickly and easily. Also the non-pulsating LED current reduces system noise and improves LED reliability. The S²Cwire interface relies on the number of rising edges to the EN/SET pin to set the register. A typical write protocol is a burst of EN/SET rising edges, followed by a pause with EN/SET held high for at least t_{LAT} (500 μ s). The programmed current is then seen at the current sink outputs. When EN/SET is held low for an amount of time longer than t_{OFF} (500 μ s), the AAT3195-1/-2 enters shutdown mode and draws less than 1 μ A from the input and the internal data register is reset to zero.

The AAT3195-1/-2's serial interface reduces the LED current on each rising pulse of the enable input. If the AAT3195-1/-2 is in shutdown, the first rising edge of the EN/SET input turns on the LED driver to the maximum current. Successive rising edges decrease the LED current as shown in Table 1 and Figure 2 for the AAT3195-1/-2.

Four-Channel Charge Pump LED Driver

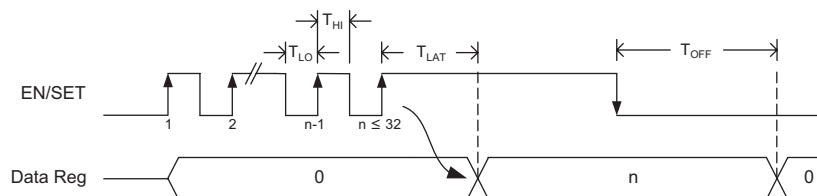

Figure 1: S²Cwire Serial Interface Timing.

Data	EN Rising Edges	AAT3195-1 D1-D4 Current (mA)	AAT3195-2 D1-D4 Current (mA)
1	1	30.0	20.5
2	2	29.0	19.8
3	3	28.1	19.2
4	4	27.1	18.5
5	5	26.1	17.8
6	6	25.1	17.2
7	7	24.2	16.5
8	8	23.2	15.8
9	9	22.3	15.2
10	10	21.3	14.5
11	11	20.3	13.9
12	12	19.4	13.2
13	13	18.4	12.5
14	14	17.4	11.9
15	15	16.5	11.2
16	16	15.5	10.6
17	17	14.5	9.9
18	18	13.6	9.2
19	19	12.6	8.6
20	20	11.6	7.9
21	21	10.7	7.3
22	22	9.7	6.6
23	23	8.7	5.9
24	24	7.7	5.3
25	25	6.8	4.6
26	26	5.8	4.0
27	27	4.8	3.3
28	28	3.9	2.6
29	29	2.9	2.0
30	30	1.9	1.3
31	31	1.0	0.7
32	32	0.5	0.3

Table 1: AAT3195-1/-2 LED Current Setting.

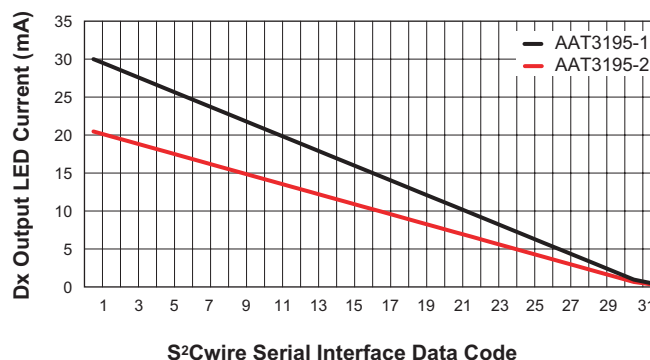

Figure 2: AAT3195-1/-2 Current Control Profile

PWM Control (AAT3195-3 only)

PWM (Pulse Width Modulation) is an industry-standard technique of controlling LED brightness by modulating the conduction duty cycle of the LED current. LED brightness is determined by the average value of the PWM signal multiplied by the LED's intensity where intensity is proportional to the LED drive current. A PWM control signal can be applied to the EN/PWM pin of the AAT3195-3. By changing the duty cycle of the PWM signal from 100% (logic high) to 10%, LEDs sink current can be programmed from 30mA to 3.0mA. To save power when not used or not needed, the AAT3195-3 can be shut down by holding the EN/PWM pin low for >1ms.

Lastly, Table 2 and Figure 3 illustrate the AAT3195-3's LED current control profile as a function of a PWM control signal.

Four-Channel Charge Pump LED Driver

EN/PWM Duty Cycle	D1-D3 Current (mA)
100%	30
90%	27
80%	24
70%	21
60%	18
50%	15
40%	12
30%	9
20%	6
10%	3

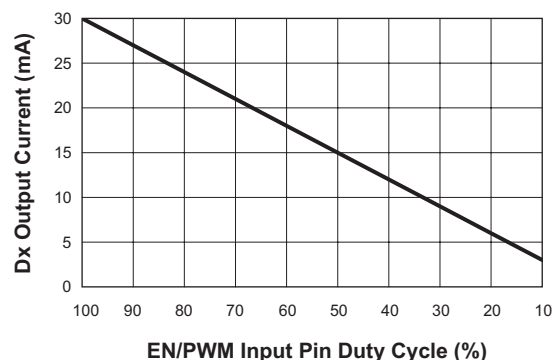
Table 2: AAT3195-3 LED Current Settings**Figure 3: AAT3195-3 Current Control Profile**

Applications Information

LED Selection

The AAT3195 is specifically intended for driving white LEDs. However, the device design will allow the AAT3195 to drive most types of LEDs with forward voltage specifications ranging from 2.0V to 4.7V. LED applications may include mixed arrangements for display backlighting, infrared (IR) diodes, and any other load needing a constant current source generated from a varying input voltage. Since the D1 to D4 constant current sinks are matched with negligible voltage dependence, the constant current channels will be matched regardless of the specific LED forward voltage (V_F) levels.

The low dropout current sinks in the AAT3195 maximize performance and make it capable of driving LEDs with high forward voltages. Multiple channels can be combined to obtain a higher LED drive current without complication. Current sink inputs that are not used should be disabled. To disable and properly terminate unused current sink inputs, they must be tied to OUT. If left unconnected or terminated to ground, the part will be forced to operate in 2x charge pump mode.

Device Switching Noise Performance

The AAT3195 operates at a fixed frequency of approximately 1MHz to control noise and limit harmonics that can interfere with the RF operation of cellular telephone handsets or other communication devices. Back-injected noise appearing on the input pin of the charge pump is

20mV peak-to-peak, typically ten times less than inductor-based DC/DC boost converter white LED backlight solutions. The AAT3195 soft-start feature prevents noise transient effects associated with inrush currents during start-up of the charge pump circuit.

Shutdown

Since the sink switches are the only power returns for all loads, there is no leakage current when all of the sink switches are disabled. To activate the shutdown mode, hold the EN/SET input low for longer than t_{OFF} (500 μ s). In this state, the AAT3195 typically draws less than 1 μ A from the input. Data and address registers are reset to 0 in shutdown.

Power Efficiency and Device Evaluation

The charge pump efficiency discussion in the following sections accounts only for efficiency of the charge pump section itself.

Since the AAT3195 outputs are pure constant current sinks and typically drive individual loads, it is difficult to measure the output voltage for a given output to derive an overall output power measurement. For any given application, white LED forward voltage levels can differ, yet the output drive current will be maintained as a constant.

This makes quantifying output power a difficult task when taken in the context of comparing to other white LED driver circuit topologies. A better way to quantify total device efficiency is to observe the total input power

Four-Channel Charge Pump LED Driver

to the device for a given LED current drive level. The best white LED driver for a given application should be based on trade-offs of size, external component count, reliability, operating range, and total energy usage...*not just % efficiency.*

The AAT3195 efficiency may be quantified under very specific conditions and is dependent upon the input voltage versus the output voltage seen across the loads applied to outputs D1 through D4 for a given constant current setting. Depending on the combination of V_{IN} and voltages sensed at the current sinks, the device will operate in load switch mode. When any one of the voltages sensed at the current sinks nears dropout, the device will operate in 2x charge pump mode. Each of these modes will yield different efficiency values. Refer to the following two sections for explanations for each operational mode.

1x Mode Efficiency

The AAT3195 1x mode is operational at all times and functions alone to enhance device power conversion efficiency when V_{IN} is higher than the voltage across the load. When in 1x mode, voltage conversion efficiency is defined as output power divided by input power:

An expression for the ideal efficiency (η) in 1X charge-pump mode can be expressed as:

$$\eta = \frac{P_{OUT}}{P_{IN}} = \frac{V_{OUT} \cdot I_{OUT}}{V_{IN} \cdot I_{OUT}} \approx \frac{V_{OUT}}{V_{IN}}$$

-or-

$$\eta (\%) = 100 \cdot \left(\frac{V_{OUT}}{V_{IN}} \right)$$

2x Charge Pump Mode Efficiency

The AAT3195 contains a fractional charge pump which will boost the input supply voltage in the event where V_{IN} is less than the voltage required to supply the output. The efficiency (η) can be simply defined as a linear voltage regulator with an effective output voltage that is equal to one and one half or two times the input voltage. Efficiency (η) for an ideal 2x charge pump can typically be expressed as the output power divided by the input power.

$$\eta = \frac{P_{OUT}}{P_{IN}}$$

In addition, with an ideal 2x charge pump, the output current may be expressed as 1/3 of the input current. The expression to define the ideal efficiency (η) can be rewritten as:

$$\eta = \frac{P_{OUT}}{P_{IN}} = \frac{V_{OUT} \cdot I_{OUT}}{V_{IN} \cdot 2I_{OUT}} = \frac{V_{OUT}}{2V_{IN}}$$

-or-

$$\eta (\%) = 100 \cdot \left(\frac{V_{OUT}}{2V_{IN}} \right)$$

For a charge pump with an output of 5V and a nominal input of 3.5V, the theoretical efficiency is 71%. Due to internal switching losses and IC quiescent current consumption, the actual efficiency can be measured at 51%. These figures are in close agreement for output load conditions from 1mA to 100mA. Efficiency will decrease substantially as load current drops below 1mA or when the voltage level at V_{IN} approaches the voltage level at V_{OUT} .

Capacitor Selection

Careful selection of the three external capacitors C_{IN} , C_P , and C_{OUT} is important because they will affect turn-on time, output ripple, and transient performance. Optimum performance will be obtained when low equivalent series resistance (ESR) ceramic capacitors are used; in general, low ESR may be defined as less than 100m Ω . A value of 1 μ F for all four capacitors is a good starting point when choosing capacitors. If the constant current sinks are only programmed for light current levels, then the capacitor size may be decreased.

Capacitor Characteristics

Ceramic composition capacitors are highly recommended over all other types of capacitors for use with the AAT3195. Ceramic capacitors offer many advantages over their tantalum and aluminum electrolytic counterparts. A ceramic capacitor typically has very low ESR, is lowest cost, has a smaller PCB footprint, and is non-polarized. Low ESR ceramic capacitors help maximize charge pump transient response. Since ceramic capacitors are non-polarized, they are not prone to incorrect connection damage.

Four-Channel Charge Pump LED Driver**Equivalent Series Resistance**

ESR is an important characteristic to consider when selecting a capacitor. ESR is a resistance internal to a capacitor that is caused by the leads, internal connections, size or area, material composition, and ambient temperature. Capacitor ESR is typically measured in milliohms for ceramic capacitors and can range to more than several ohms for tantalum or aluminum electrolytic capacitors.

Ceramic Capacitor Materials

Ceramic capacitors less than $0.1\mu\text{F}$ are typically made from NPO or COG materials. NPO and COG materials generally have tight tolerance and are very stable over

temperature. Larger capacitor values are usually composed of X7R, X5R, Z5U, or Y5V dielectric materials. Large ceramic capacitors (i.e., larger than $2.2\mu\text{F}$) are often available in low cost Y5V and Z5U dielectrics, but capacitors larger than $1\mu\text{F}$ are not typically required for AAT3195 applications.

Capacitor area is another contributor to ESR. Capacitors that are physically large will have a lower ESR when compared to an equivalent material smaller capacitor. These larger devices can improve circuit transient response when compared to an equal value capacitor in a smaller package size.

AAT3195

Four-Channel Charge Pump LED Driver

Evaluation Board Schematic

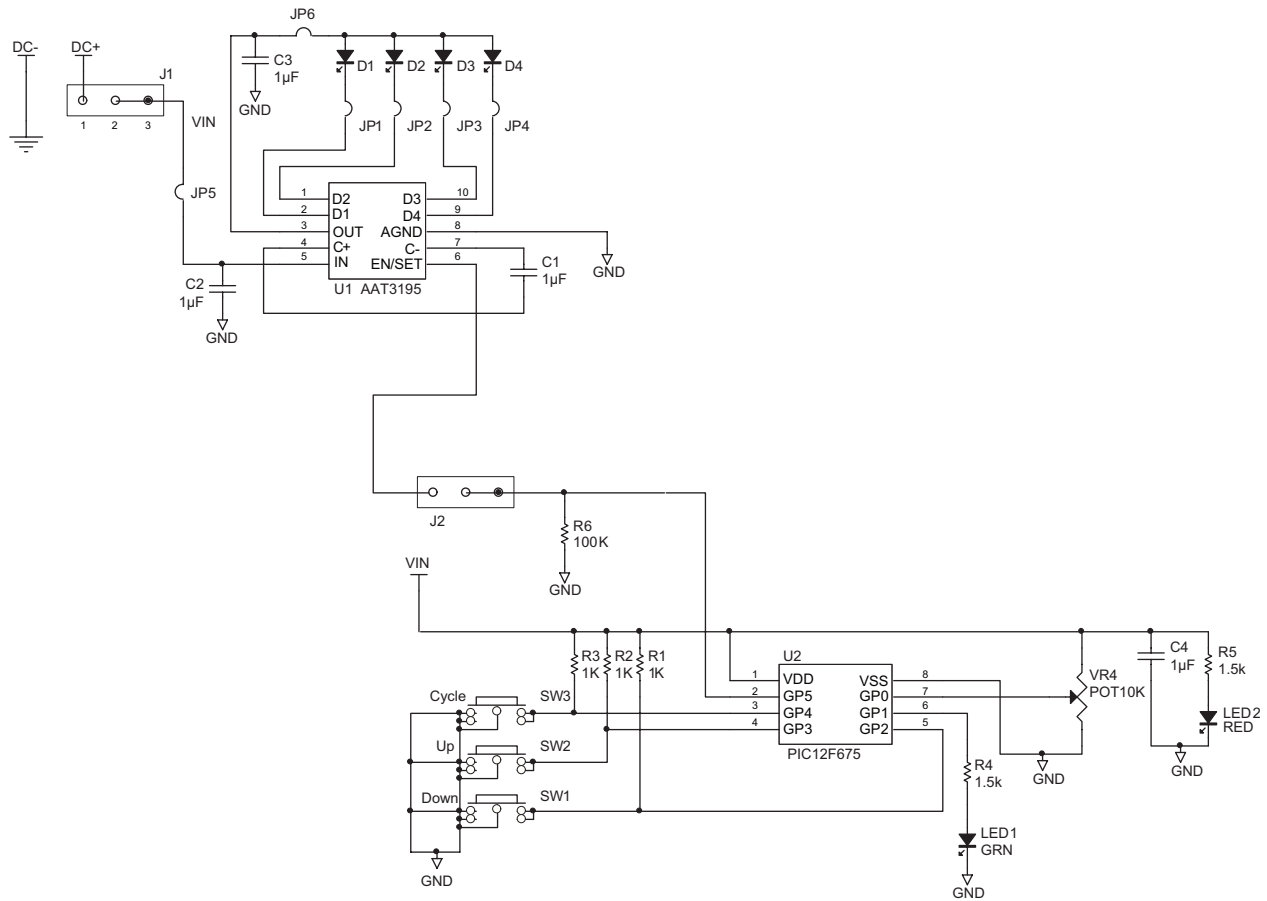

Evaluation Board Layout

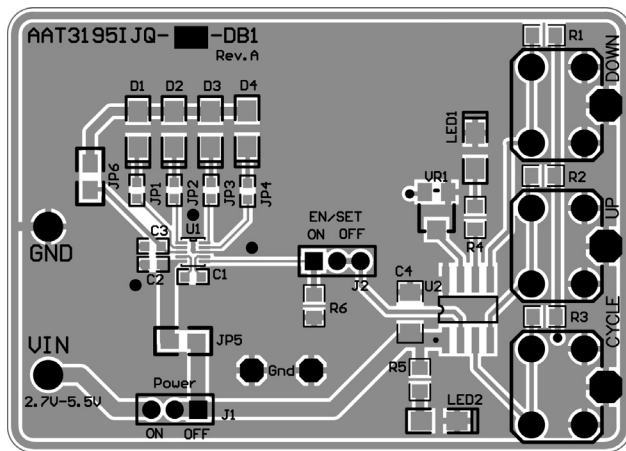

Figure 4: AAT3195 Evaluation Board Top Side Layout.

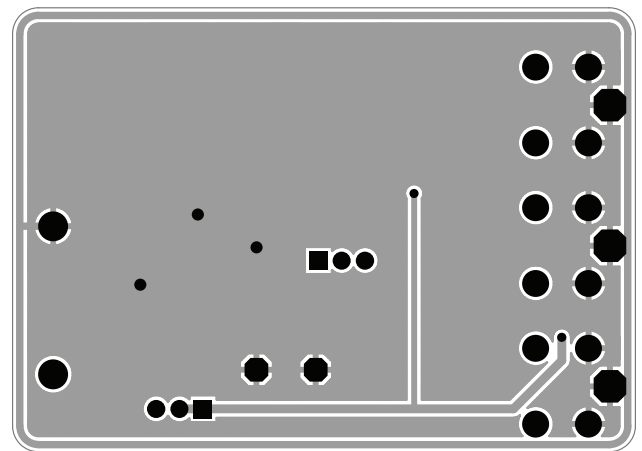

Figure 5: AAT3195 Evaluation Board Bottom Side Layout.

AAT3195

Four-Channel Charge Pump LED Driver

Ordering Information

Package	Interface	Current Level, Inverting	Marking ¹	Part Number (Tape and Reel) ²
SC70JW-10	S ² Cwire	30mA, 32-step	3FXY	AAT3195IJQ-1-T1
SC70JW-10	S ² Cwire	20mA, 32-step	3XXYY	AAT3195IJQ-2-T1
SC70JW-10	PWM	Linear		AAT3195IJQ-3-T1



Skyworks Green™ products are compliant with all applicable legislation and are halogen-free.



For additional information, refer to *Skyworks Definition of Green™*, document number SQ04-0074.

Package Information

SC70JW-10

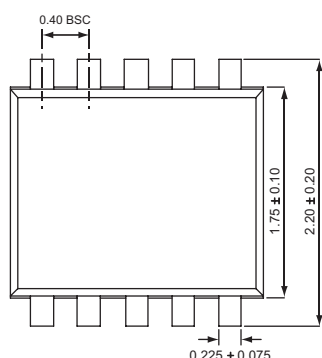

Top View

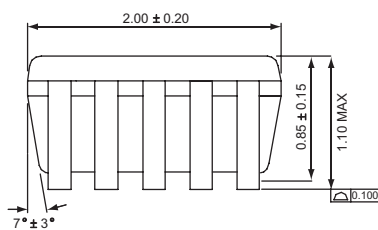

Side View

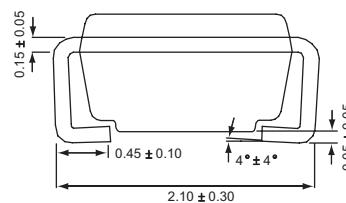

End View

All dimensions in millimeters.

1. XYY = assembly and date code.
2. Sample stock is generally held on part numbers listed in **BOLD**.

Four-Channel Charge Pump LED Driver

Copyright © 2012 Skyworks Solutions, Inc. All Rights Reserved.

Information in this document is provided in connection with Skyworks Solutions, Inc. ("Skyworks") products or services. These materials, including the information contained herein, are provided by Skyworks as a service to its customers and may be used for informational purposes only by the customer. Skyworks assumes no responsibility for errors or omissions in these materials or the information contained herein. Skyworks may change its documentation, products, services, specifications or product descriptions at any time, without notice. Skyworks makes no commitment to update the materials or information and shall have no responsibility whatsoever for conflicts, incompatibilities, or other difficulties arising from any future changes.

No license, whether express, implied, by estoppel or otherwise, is granted to any intellectual property rights by this document. Skyworks assumes no liability for any materials, products or information provided hereunder, including the sale, distribution, reproduction or use of Skyworks products, information or materials, except as may be provided in Skyworks Terms and Conditions of Sale.

THE MATERIALS, PRODUCTS AND INFORMATION ARE PROVIDED "AS IS" WITHOUT WARRANTY OF ANY KIND, WHETHER EXPRESS, IMPLIED, STATUTORY, OR OTHERWISE, INCLUDING FITNESS FOR A PARTICULAR PURPOSE OR USE, MERCHANTABILITY, PERFORMANCE, QUALITY OR NON-INFRINGEMENT OF ANY INTELLECTUAL PROPERTY RIGHT; ALL SUCH WARRANTIES ARE HEREBY EXPRESSLY DISCLAIMED. SKYWORKS DOES NOT WARRANT THE ACCURACY OR COMPLETENESS OF THE INFORMATION, TEXT, GRAPHICS OR OTHER ITEMS CONTAINED WITHIN THESE MATERIALS. SKYWORKS SHALL NOT BE LIABLE FOR ANY DAMAGES, INCLUDING BUT NOT LIMITED TO ANY SPECIAL, INDIRECT, INCIDENTAL, STATUTORY, OR CONSEQUENTIAL DAMAGES, INCLUDING WITHOUT LIMITATION, LOST REVENUES OR LOST PROFITS THAT MAY RESULT FROM THE USE OF THE MATERIALS OR INFORMATION, WHETHER OR NOT THE RECIPIENT OF MATERIALS HAS BEEN ADVISED OF THE POSSIBILITY OF SUCH DAMAGE.



Skyworks products are not intended for use in medical, lifesaving or life-sustaining applications, or other equipment in which the failure of the Skyworks products could lead to personal injury, death, physical or environmental damage. Skyworks customers using or selling Skyworks products for use in such applications do so at their own risk and agree to fully indemnify Skyworks for any damages resulting from such improper use or sale.

Customers are responsible for their products and applications using Skyworks products, which may deviate from published specifications as a result of design defects, errors, or operation of products outside of published parameters or design specifications. Customers should include design and operating safeguards to minimize these and other risks. Skyworks assumes no liability for applications assistance, customer product design, or damage to any equipment resulting from the use of Skyworks products outside of stated published specifications or parameters.

Skyworks, the Skyworks symbol, and "Breakthrough Simplicity" are trademarks or registered trademarks of Skyworks Solutions, Inc., in the United States and other countries. Third-party brands and names are for identification purposes only, and are the property of their respective owners. Additional information, including relevant terms and conditions, posted at www.skyworksinc.com, are incorporated by reference.

Looking for pricing, stock, or lifecycle information?

Click below to explore more details on WIN SOURCE:

-  [View AAT3195IJQ-2-T1 on WIN SOURCE](#)
-  [Skyworks Solutions Inc. Information](#)

Optimize Your Supply Chain with WIN SOURCE Solutions

-  Global Sourcing Solution
-  Obsolete Management
-  Cost Control Management
-  Shortage Management
-  Alternative Solution
-  Excess Inventory Management