



**THE DATASHEET OF
AAT1274IWO-T1**



General Description

The AAT1274 is a high-efficiency, 1.5A high-current boost converter for LED photo flash applications. It maintains output current regulation by switching the internal high-side and low-side switch transistors, pulse-width modulated at a fixed frequency of 2MHz. The high switching frequency allows the use of a small external inductor and output capacitor, making the AAT1274 ideally suited in all single cell, Li-ion-powered applications.

Skyworks' proprietary AS²Cwire™ (Advanced Simple Serial Control™) serial digital interface is used to enable, disable, configure, and program the operation of the AAT1274. Using the AS²Cwire interface, the movie-mode current level for each LED, and the flash-to-movie-mode current ratio can be programmed to one of 16 levels. The AAT1274 includes a separate Flash Enable input to initiate the flash operation and a Flash Inhibit pin which reduces the flash current to movie-mode levels during high battery demand.

The maximum flash and movie-mode current is set by one external resistor where the ratio of flash to movie-mode current is set at approximately 7.3:1. The AAT1274 can drive one high current LED.

The AAT1274 contains a thermal management system to protect the device in the event of an output short-circuit condition. Built-in circuitry prevents excessive inrush current during start-up. The shutdown feature reduces quiescent current to less than 1.0µA.

The AAT1274 is available in a Pb-free, thermally-enhanced TDFN33-14 package and operates over the -40°C to 85°C temperature range.

Typical Application

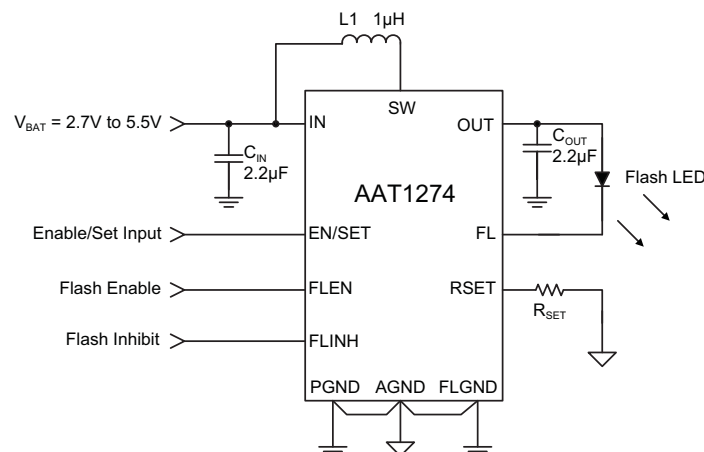

Features

- Input Voltage Range: 2.7V to 5.5V
- Single Channel Flash Output
- Up to 1.5A Regulated Output Current
- Up to 88% Efficiency
- 2 MHz Switching Frequency
- Separate Flash Enable
- Single Resistor Sets Flash and Movie Mode Current
 - AS²Cwire Single Wire Programming:
 - Movie Mode Current
 - Flash/Movie Mode Current Ratio
- True Load Disconnect
- Soft-Start and Input Current Limit
- Over-Voltage (Open LED, Open Circuit), Short Circuit, and Over-Temperature Protection
- -40°C to +85°C Temperature Range
- TDFN33-14 Package

Applications

- LED Photo Flash / Torch
- Camera Enabled Mobile Devices
- Cellphones/Smartphones
- Digital Still Cameras (DSCs)
- Multimedia Mobile Phones

AAT1274

I.5A Single Flash LED Driver IC

Pin Descriptions

Pin #	Symbol	Description
1,5	AGND	Analog ground pin. Connect AGND to PGND, and FLGND at a single point as close to the AAT1274 as possible.
2	EN/SET	Enable and Serial Control input. EN/SET is the AS2Cwire addressing and programming input to: a) adjust the movie-mode current level; b) select the Flash-to-Movie-mode ratio;
3	FL	LED Flash current sink pin. Connect the cathode of Flash LED to FL.
4	FLEN	Flash enable pin. A low-to-high transition on the FLEN pin initiates a flash pulse and a high-to-low transition on the FLEN pin terminates a flash pulse
6	IN	Flash output boost converter power input. Connect IN to the input power source. Connect a 2.2μF or larger ceramic capacitor from IN to PGND and locate as close as possible to the AAT1274 package for optimum performance.
7	PGND	Power ground. Connect PGND to the same single point as AGND located as close to the AAT1274 as possible
8	OUT	Power output of the boost converter. Connect a 2.2μF or larger ceramic capacitor from OUT to PGND as close as possible to the AAT1274. Connect OUT to the anode of the Flash LED.
9, 12	NC	Not connected
10	SW	Boost converter switching node. Connect a 1μH inductor between SW and IN.
11	FLINH	Flash inhibit pin. FLINH is an active HIGH control input with an internal 200kΩ resistor to AGND. A low-to-high transition on the FLINH pin reduces FL sink current to the maximum (default) movie-mode current level.
13	FLGND	Flash ground pin. Connect FLGND to PGND, and AGND at a single point as close to the AAT1274 as possible.
14	RSET	Flash current set pin. Connect a resistor from RSET to AGND to program the desired flash current for the current sink FL.
EP		Electrical back contact. Connect to a good thermal ground pad

Pin Configuration

**TDFN33-14
(Top View)**

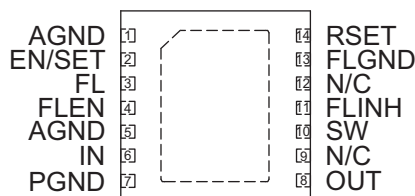

Absolute Maximum Ratings¹

$T_A = 25^\circ\text{C}$ unless otherwise noted.

Symbol	Description	Value	Units
IN, OUT, SW	Maximum Rating	-0.3 to 6.0	V
EN/SET, FLEN, FLINH, RSET, FL	Maximum Rating	-0.3 to $V_{IN} + 0.3$	
T_J	Operating Junction Temperature Range	-40 to 150	$^\circ\text{C}$
T_S	Storage Temperature Range	-65 to 150	
T_{LEAD}	Maximum Soldering Temperature (at Leads, 10 sec)	300	

Thermal Information²

Symbol	Description	Value	Units
Θ_{JA}	Thermal Resistance ³	50	$^\circ\text{C}/\text{W}$
P_D	Maximum Power Dissipation	2	W

1. Stresses above those listed in Absolute Maximum Ratings may cause permanent damage to the device. Functional operation at conditions other than the operating conditions specified is not implied.
2. Mounted on an FR4 board.
3. Derate 20mW/ $^\circ\text{C}$ above 25 $^\circ\text{C}$.

Electrical Characteristics

$V_{IN} = 3.6V$; $C_{IN} = C_{OUT} = 2.2\mu F$; $R_{SET} = 107k\Omega$; $L = 1\mu H$. $T_A = -40^\circ C$ to $85^\circ C$ unless otherwise noted. Typical values are at $T_A = 25^\circ C$.

Symbol	Description	Conditions	Min	Typ	Max	Units
Power Supply – Switching Flash Driver						
V_{IN}	Input Voltage Range		2.7		5.5	V
$V_{OUT(MAX)}$	Maximum Output Voltage				5.5	V
$I_{IN(Q)}$	Supply Current	EN/SET = FLEN = IN, Set FL Load = 1.5A		0.67	1	mA
		EN/SET = IN, FLEN = AGND		0.23		
$I_{SHDN(MAX)}$	Input Shutdown Current	EN/SET, FLEN, = AGND			1.0	μA
I_{FL}	Output Current, Flash Mode	$R_{SET} = 107k\Omega$	1.2	1.5		A
$I_{FL(ACC)}$	Flash Current Accuracy	$R_{SET} = 107k\Omega = 1.2A$		± 10		%
$I_{MM(LOAD)}$	Total Output Current, Movie Mode	$R_{SET} = 107k\Omega$, Movie mode current set to 100%		206		mA
F_{OSC}	Switching Frequency	$T_A = 25^\circ C$	1.5	2.0	2.5	MHz
T_{SD}	Over-Temperature Shutdown Threshold			140		$^\circ C$
$T_{SD(HYS)}$	Over-Temperature Shutdown Hysteresis			15		$^\circ C$
EN/SET, FLEN						
$V_{EN/SET(H)}, V_{FLEN(H)}$	EN/SET, FLEN Input High Threshold		1.4			V
$V_{EN/SET(L)}, V_{FLEN(L)}$	EN/SET, FLEN Input Low Threshold				0.4	V
$I_{EN/SET}, I_{FLEN}$	EN/SET, FLEN Input Leakage Current	$V_{EN/SET}, V_{FLEN} = IN = 5V$	-1		1	μA
$V_{T(FLINH)}$	FLINH Input Threshold Voltage			$\frac{1}{2} I_N$		V
$R_{IN(FLINH)}$	FLINH Input Resistance to AGND			200		$k\Omega$
$t_{EN/SET(LO)}$	EN/SET Serial Interface Low Time		0.3		75	μs
$t_{EN/SET(HI-MIN)}$	Minimum EN/SET High Time			50		ns
$t_{EN/SET(HI-MAX)}$	Maximum EN/SET High Time				75	μs
$t_{EN/SET(OFF)}$	EN/SET Off timeout time				500	μs
$t_{ENSET(LAT)}$	EN/SET Latch Timeout Time				500	μs
$t_{FLEN(ON)}$	FLEN On Delay Time	EN/SET = AGND		40		μs
$t_{FLEN(OFF)}$	FLEN Off Delay Time	EN/SET = AGND		10		μs
t_{FLINH_ON}	FLINH ON Delay Time			93		μs

AAT1274

1.5A Single Flash LED Driver IC

Typical Characteristics

Flash Mode Efficiency vs. Input Voltage

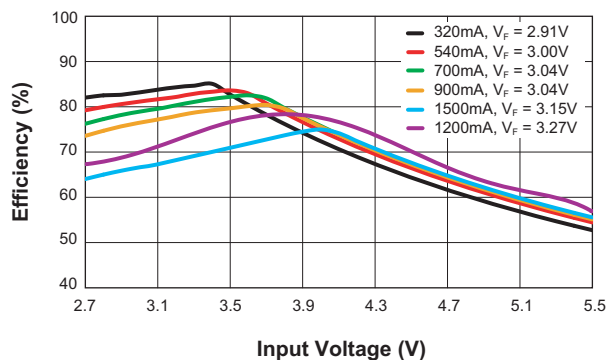

Movie Mode Efficiency vs. Input Voltage

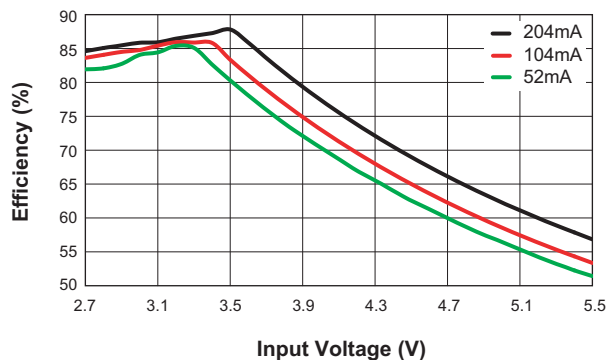

Boost Switching Frequency vs. Input Voltage
(Movie Mode; L = 1μH)

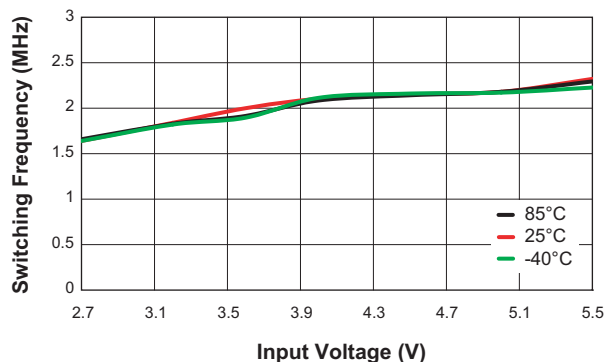

Shutdown Current vs. Input Voltage
($V_{EN/SET} = V_{FLEN} = 0V$)

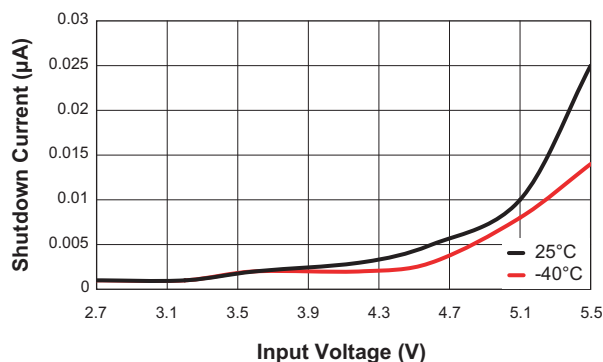

Supply Current vs. Input Voltage
($V_{EN} = V_{FLEN} = 3.6V$)

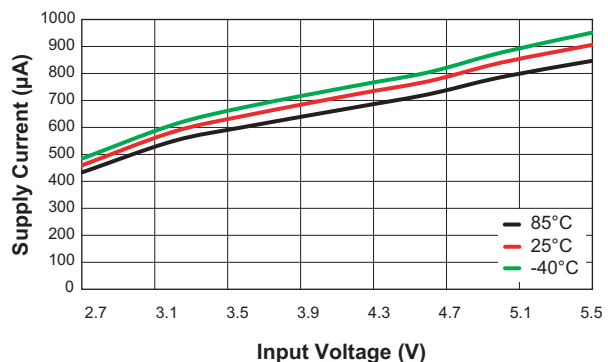

Movie Mode LED Current vs. Temperature
($I_{FL} = 206mA/Ch$; $V_{IN} = 3.6V$; L = 1μH)

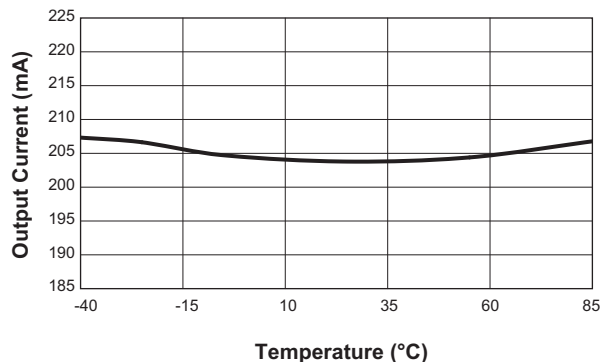

AAT1274

1.5A Single Flash LED Driver IC

Typical Characteristics

Movie Mode LED Current Accuracy vs. Input Voltage
($I_{FL} = 206\text{mA}$; $L = 1\mu\text{H}$)

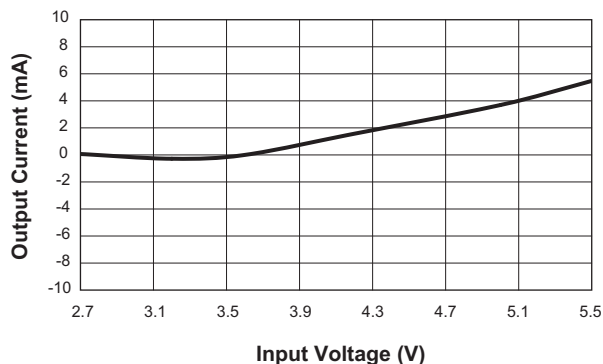

Movie Mode Output Ripple
($I_{FL} = 206\text{mA}$; $V_{IN} = 3.6\text{V}$; $L = 1\mu\text{H}$)

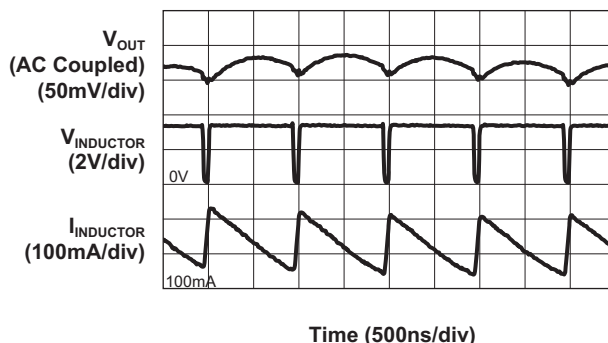

Flash Mode Output Ripple
($I_{FL} = 1.5\text{A}$; $V_{IN} = 4\text{V}$; $L = 1\mu\text{H}$)

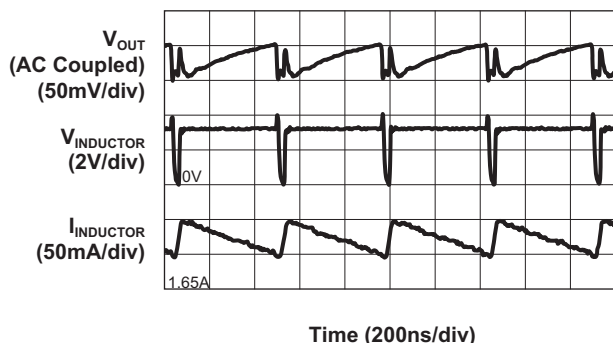

Flash LED Current vs. Temperature
($I_{FL} = 1.5\text{A}$; $V_{IN} = 4.2\text{V}$; $L = 1\mu\text{H}$)

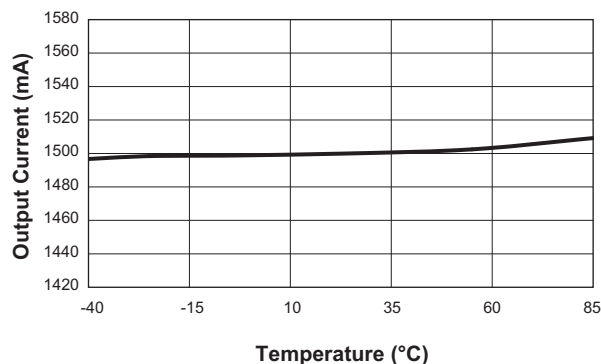

Flash On Time Delay vs. Input Voltage
($I_{FL} = 1.5\text{A}$; $C_{OUT} = 2.2\mu\text{F}$; $L = 1\mu\text{H}$)

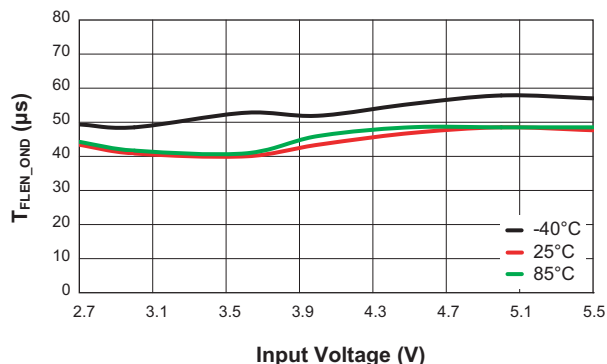

Movie Mode Line Transient
($I_{FL} = 206\text{mA}$; $V_{IN} = 4.2\text{V to } 3.6\text{V}$)

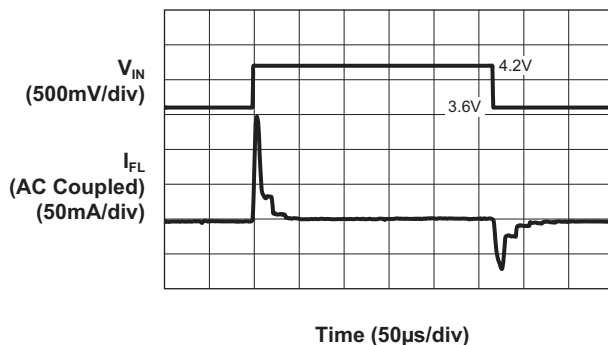

AAT1274

1.5A Single Flash LED Driver IC

Typical Characteristics

Flash Turn On Characteristic
($I_{FL} = 1.5A$; $V_{IN} = 3.6V$; $L = 1\mu H$)

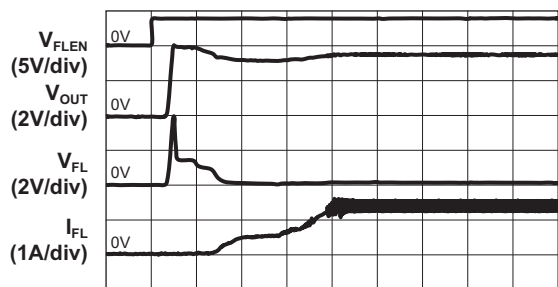

Time (50µs/div)

Movie Mode to Flash Turn On Characteristic
($I_{FL} = 206mA$ to $1.5A$; $V_{IN} = 3.6V$; $L = 1\mu H$)

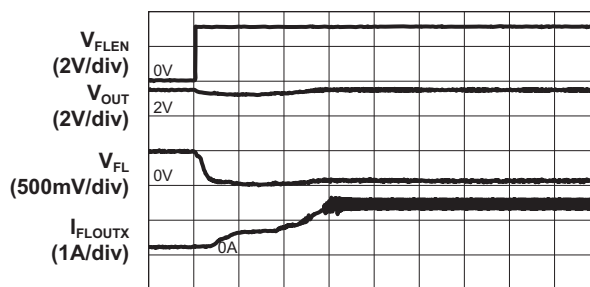

Time (50µs/div)

Movie Mode Turn On Characteristic
($I_{FL} = 206mA$; $V_{IN} = 3.6V$; $L = 1\mu H$)

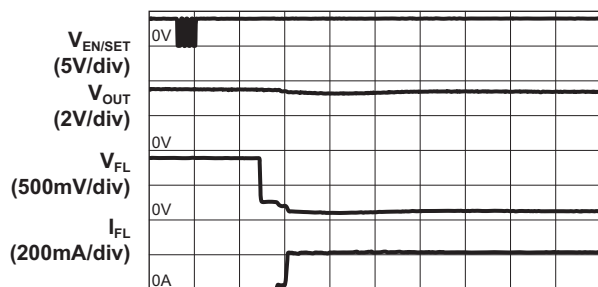

Time (100µs/div)

Movie Mode Transition Characteristic
($I_{FL} = 206mA$ to $376mA$; $C_{OUT} = 0.22\mu F$; $V_{IN} = 3.6V$; $L = 1\mu H$)

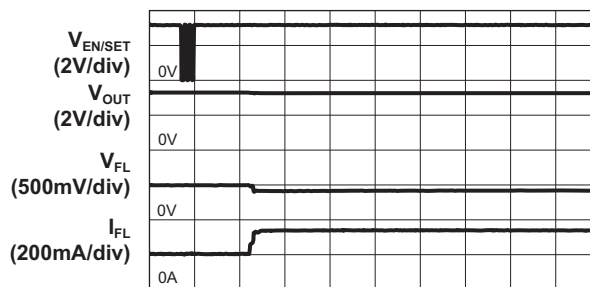

Time (100µs/div)

EN, FLEN High Threshold Voltage vs. Input Voltage

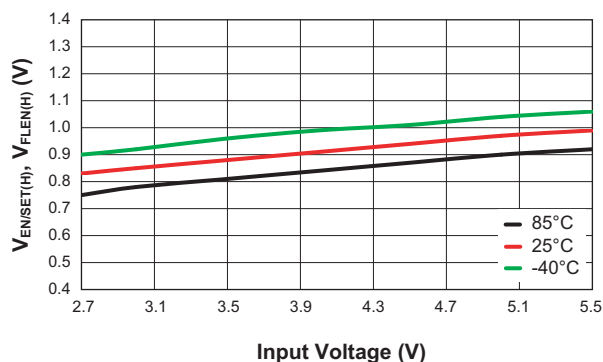

EN, FLEN Low Threshold Voltage vs. Input Voltage

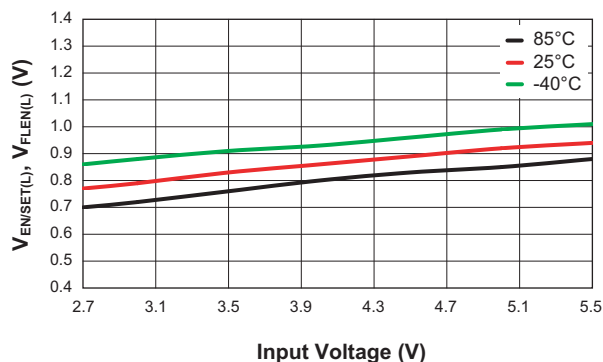

Typical Characteristics

EN/SET Off Timeout vs. Input Voltage

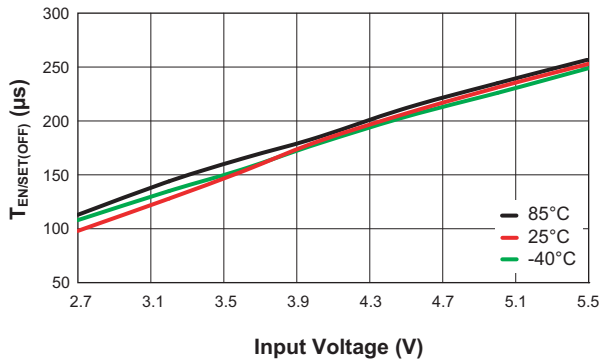

EN/SET Latch Timeout vs. Input Voltage

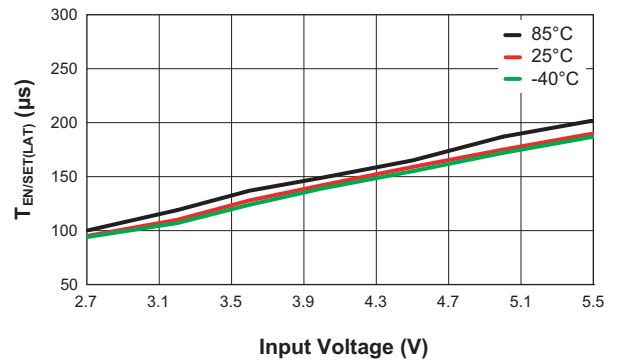

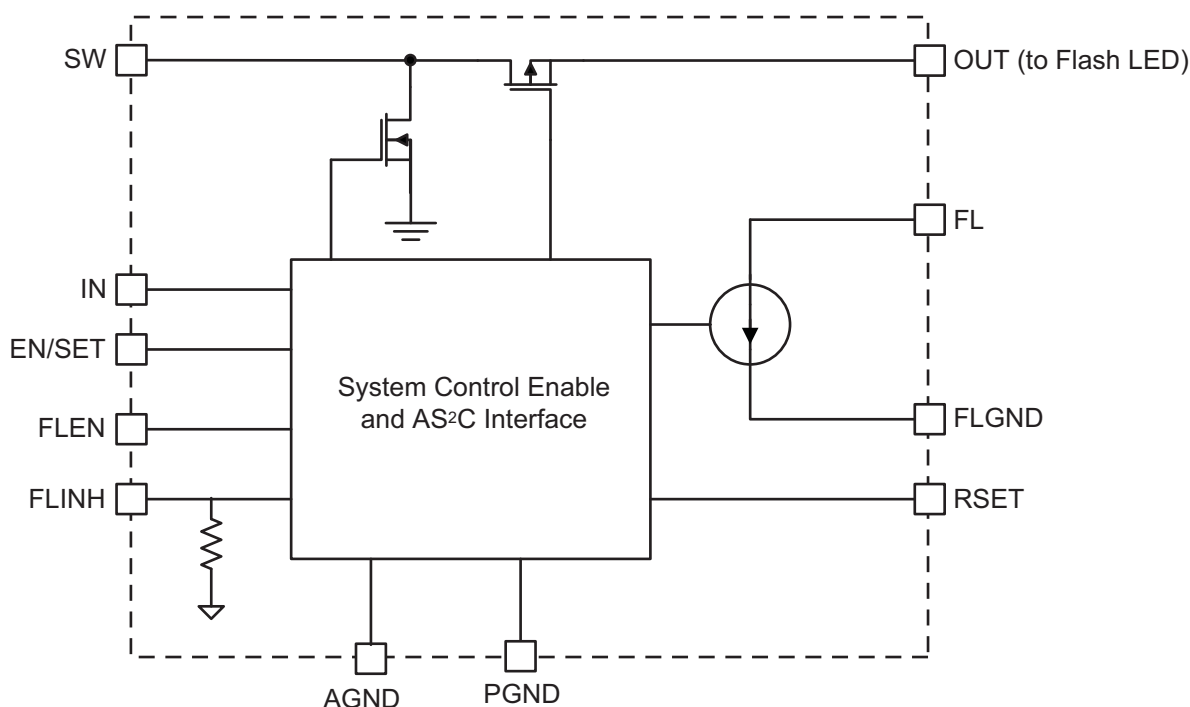
Functional Block Diagram**Functional Description**

The AAT1274 is a boost converter with a current regulated output designed to drive high current white LED used in camera flash applications. The AAT1274 has a constant current sink channel to accurately regulate the current flow through a high current, high intensity white flash LED. The AAT1274 has two basic operating modes; a flash mode controlled by the FLEN pin and the movie/torch light mode controlled through the AS²Cwire interface.

Flash Mode

A flash pulse may be initiated by pulling the FLEN input pin from a logic low-to-high state, which initiates a flash pulse. The maximum flash current in the AAT1274 is set by an external resistor, R_{SET} , which sets the flash current and the maximum movie-mode current.

In mobile GSM systems where the phone remains in constant contact with the base station by regular communication, a FLINH pin is provided to prevent both the

camera flash and PA transmission pulses from occurring simultaneously. This avoids potential dips to the Li-ion battery voltage below the system's undervoltage lockout threshold (UVLO). During a flash event, strobing the FLINH pin low-to-high reduces the LED current to the default movie-mode current level for the duration of FLINH. Strobing FLINH high-to-low instructs the AAT1274 to revert the flash LED current to its maximum level, assuming that the FLEN pin is still active (high).

Movie (Torch) Mode

The movie / torch mode current level, and the flash to maximum movie mode current ratio are programmed by the AAT1274 AS²Cwire interface. The movie-mode current level can be adjusted to one of 16 steps using a logarithmic scale where each code level is 1dB below the previous code. The flash to maximum movie mode current ratio can be set from 1:2 to 1:30 with respect to the maximum programmed flash current as set by the R_{SET} resistor. The manual FLEN signal has priority over movie-mode operation.

Movie mode operation is controlled entirely by the AS²Cwire interface via the EN/SET pin. The FLEN signal will override movie-mode AAT1274 operation when toggled to a logic high level. The part will not reenter movie mode when FLEN is brought low. To reenter movie mode after a flash event the part must be cycled off and back on to reset the movie mode and reprogrammed via the AS²Cwire interface to the desired movie mode operation.

Over-Voltage Protection (Open Flash LED, Open Circuit)

The AAT1274 boost converter output is voltage limited by internal overvoltage protection circuitry to prevent damage to the device in the event an open LED or open circuit condition occurs. During an open circuit condition, the output voltage will rise to 5.5V (typical). The OVP circuit disables the boost converter to prevent the output voltage from rising above 5.5V. Once the open circuit condition is removed, normal boost operation will resume.

Short Circuit Protection

The AAT1274 is equipped with an auto-disable feature for the flash LED channel. After the IC is enabled and system start up commences, a test current of 2-3mA (typical) is forced through the sink channel. The channel will be disabled if the voltage of the SINK pin does not drop to a predetermined threshold. This feature is very convenient for disabling the current sink in the event the flash LED fails to a short circuit. This small test current is added to the set output current in both Flash and movie mode conditions.

Over-Temperature Protection

The AAT1274 has internal thermal protection circuitry to disable the device if the internal power dissipation exceeds a preset thermal limit. The junction over-temperature threshold is 140°C with 15°C of temperature hysteresis. During flash or movie-mode operation, if an environmental condition, flash current sink, or the boost converter causes the internal die temperature to rise above 140°C, the boost converter will be shut down. The boost converter output operation will automatically recover when the over-temperature fault condition is removed.

Application Information

Flash Mode LED Current

Flash sink current can be programmed up to a maximum of 1.5A. The maximum flash current is set by the R_{SET} resistor. For the desired flash current, the resistor value can be calculated using the following equation:

$$I_{FL} = \frac{162k\Omega \times A}{R_{SET}} = \frac{162k\Omega}{107k\Omega} = 1.5A$$

A flash event is initiated by asserting the FLEN pin. A flash event is automatically terminated when FLEN is deasserted. Any time that the FLINH pin is asserted, the default movie-mode current level will appear at FL channel. The default movie mode current level will be maintained on FL as long as the FLINH and FLEN pins are asserted. In addition to setting the flash current via R_{SET}, the flash current can be changed after FLEN is asserted by programming the movie mode current register with 16 different steps.

AS²Cwire Control of Movie Mode Operation

In the AAT1274 control of the movie mode operation is managed by the Advanced Simple Serial Control (AS²Cwire) interface. AS²Cwire relies on the number of rising edges of the EN/SET pin to address and load internal data registers. Referring to Table 1:

- Address 0 controls the movie mode (MM) current level as a percentage of the maximum movie mode current level.
- Address 3 sets the maximum possible current for movie mode operation. The maximum movie mode current is set as a fraction of the flash current with a peak value of 1/2 and default value of 1/7.3.
- The last column in Table 1 shows the default values for each of the address registers.

I.5A Single Flash LED Driver IC

Address	EN/SET Rising Edges	Function	Default (No Programming)
0	17	Movie Mode Current	100%
1		Not Used	
2		Not Used	
3	20	Flash/Movie Mode Current Ratio	1/7.3

Table 1: AS²Cwire Serial Interface Addressing.

AS²Cwire Serial Interface

AS²Cwire latches data or address after the EN/SET pin has been held high for longer than t_{LAT} (500 μ s). Address or data are differentiated by the number of EN/SET rising edges. Since the data registers are 4 bits each, the differentiating number of pulses is 2^4 or 16, so that Address 0 is signified by 17 rising edges, and Address 3 by 20 rising edges. Data is inclusively applied to any number of rising edges between 1 and 16. A typical write protocol is a burst of EN/SET rising edges which signify a particular address that is followed by a pause with EN/SET held high for the prescribed t_{LAT} timeout period, then a burst of rising edges signifying data, and a t_{LAT} timeout for the data registers. Once an address is set, then multiple writes to the corresponding data register are allowed. Address 0 is the default address on the first rising edge

after the AAT1274 has been disabled. When EN/SET is transitioned from high to low and held low longer than t_{OFF} (500 μ s), the device enters a shutdown mode and draws less than 1 μ A from the input supply. All data and address are cleared (reset to 0) during shutdown. AS²Cwire addressing allows for control of the movie mode output current, and the ratio of movie-mode current to flash current. If there are no programmed write instructions applied to the EN/SET pin prior to the assertion of the FLEN pin and the device is enabled, then all registers will be loaded with their default values shown in Table 1. In the event that the number of rising edges applied at the EN/SET pin is less than 17, the internal state machine will interpret instruction to program the output currents to the desired current level for movie-mode operation.

Movie Mode Current – Address 0

The AAT1274 movie mode current settings are controlled using the AS²Cwire interface. The default ratio between the flash current level and maximum movie mode current level is 1:7.3.

For example, if an R_{SET} value of 107k Ω is chosen, then the flash current is set to 1500mA. For movie mode operation, the maximum current available is then:

$$I_{MOVIE\ MODE} = \frac{I_{FL(MAX)}}{7.3} = \frac{1500mA}{7.3} = 206mA$$

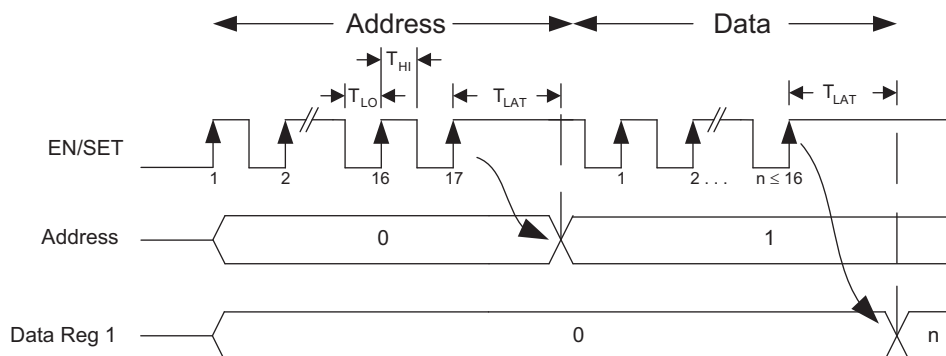

Figure 1: AS²Cwire Serial Interface Timing Diagram.

1.5A Single Flash LED Driver IC

Address 0 controls precise movie mode current levels. The movie mode current can be adjusted in a logarithmic fashion to one of 16 steps represented as a fraction of the maximum movie mode current in Table 2. On initial EN, the movie-mode output immediately supplies 100% of the set movie-mode current.

Data	Percentage of Maximum MM Current
1*	100%
2	89%
3	79%
4	71%
5	63%
6	56%
7	50%
8	45%
9	40%
10	36%
11	32%
12	28%
13	25%
14	22%
15	20%
16	0%

Table 2: Address 0, Movie Mode (MM) Current Programming.

Flash to Maximum Movie Mode Current Ratio – Address 3

The maximum movie mode current is a fixed ratio of the flash current controlled by Address 3. The ratio may be varied from 1:2 to OFF in 16 linear steps as shown in Table 3. The default value for Address 3 is Data = 4 and represents a flash to maximum movie mode current level of 1 to 7.3. The default maximum movie mode current can be calculated:

$$I_{\text{MOVIE MODE}} = \frac{I_{\text{FL(MAX)}}}{7.3}$$

For example, if an R_{SET} value of 107k Ω is chosen, then the flash current is set to 1500mA. For movie mode operation, the maximum current available is then:

$$I_{\text{MOVIE MODE}} = \frac{1500\text{mA}}{7.3} = 206\text{mA}$$

The maximum movie mode current level can be calculated using the following equation:

$$I_{\text{MOVIE MODE}} = \frac{107\text{k}\Omega \times A}{R_{\text{SET}}} = \frac{1}{\text{FL to MM Ratio}} = \text{Max Movie Mode Current}$$

Data	Flash to Movie Mode Ratio
1	1/2
2	1/3.8
3	1/5.5
4*	1/7.3
5	1/8.9
6	1/10.5
7	1/12.2
8	1/13.8
9	1/14.9
10	1/16.5
11	1/18
12	1/19.6
13	1/21.1
14	1/22.6
15	1/24
16	OFF

Table 3: Address 3, Flash/ Movie Mode Current Ratio.

Shutdown

Since the flash current sink is the only power returns for the flash LED loads, there is no leakage current to load if all the sink switches are disabled. When the EN/SET pin is held low for an amount of time greater than t_{OFF} (500 μs), the AAT1274 flash boost converter section enters shutdown mode and draws less than 1 μA from the input power source. All data and address registers for the flash and/or movie mode are cleared (reset to 0) during shutdown.

Selecting the Boost Inductor

The AAT1274 controller utilizes PWM control and the switching frequency is fixed. To maintain 2MHz maximum switching frequency and stable operation, a 1 μH inductor is recommended. Manufacturer's specifications list both the inductor DC current rating, which is a thermal limitation, and peak inductor current rating, which is determined by the saturation characteristics. Measurements at full load and high ambient temperature should be performed to ensure that the inductor does not saturate or exhibit excessive temperature rise.

* Denotes the default value.

1.5A Single Flash LED Driver IC

Selecting the Boost Capacitors

In general, it is a good design practice to place a decoupling capacitor (input capacitor) between the IN and ground. An input capacitor in the range of 2.2 μ F to 10 μ F is recommended. A larger input capacitor in this application may be required for stability, transient response, and/or ripple performance. The high output ripple inherent in the boost converter necessitates the use of low impedance output filtering. Multi-layer ceramic (MLC) capacitors provide small size and adequate capacitance, low parasitic equivalent series resistance (ESR) and equivalent series inductance (ESL), and are well suited for use with the AAT1274 boost regulator. MLC capacitors of type X7R or X5R are recommended to ensure good capacitance stability over the full operating temperature range. The output capacitor is selected to maintain the output load without significant voltage droop (ΔV_{OUT}) during the power switch ON interval. A 2.2 μ F ceramic output capacitor is recommended (see Table TBD). Typically, 6.3V or 10V rated capacitors are required for this flash LED boost output application. Ceramic capacitors selected as small as 0603 are available which meet these requirements. MLC capacitors exhibit significant capacitance reduction with applied voltage. Output ripple measurements should confirm that output voltage droop and operating stability are within acceptable limits. Voltage de-rating can minimize this factor, but results may vary with package size among specific manufacturers. To maintain stable operation at full load, the output capacitor should be selected to maintain ΔV_{OUT} between 100mV and 200mV. The boost converter input current flows during both ON and OFF switching intervals. The input ripple

current is less than the output ripple and, as a result, less input capacitance is required.

PCB Layout Guidelines

Boost converter performance can be adversely affected by poor layout. Possible impact includes high input and output voltage ripple, poor EMI performance, and reduced operating efficiency. Every attempt should be made to optimize the layout in order to minimize parasitic PCB effects (stray resistance, capacitance, and inductance) and EMI coupling from the high frequency SW node. A suggested PCB layout for the AAT1274 1.5A step-up regulator is shown in Figures 3 and 4. The following PCB layout guidelines should be considered:

1. Minimize the distance from capacitor C_{IN} and C_{OUT} 's negative terminals to the PGND pins. This is especially true with output capacitor C_{OUT} , which conducts high ripple current from the output to the PGND pins.
2. Minimize the distance under the inductor between IN and switching pin SW; minimize the size of the PCB area connected to the SW pin.
3. Maintain a ground plane and connect to the IC PGND pin(s) as well as the PGND connections of C_{IN} and C_{OUT} .
4. Consider additional PCB exposed area for the flash LED to maximize heatsinking capability. This may be necessary when using high current application and long flash duration application.
5. Connect the exposed paddle (bottom of the die) to PGND or GND. Connect AGND, FLGND to GND as close as possible to the package.

Manufacturer	Part Number	Inductance (μ H)	Saturated Rated Current (A)	DCR (m Ω)	Size (mm) LxWxH	Type
Cooper Bussmann	SD3812-1R0-R	1	2.69	48	4.0 x 4.0 x 1.2	shielded drum core
Cooper Bussmann	SDH3812-1R0-R	1	3	45	3.8 x 3.8 x 1.2	shielded drum core
Cooper Bussmann	SD10-1R0-R	1	2.25	44.8	5.2 x 5.2 x 1.0	shielded drum core
Sumida	CDH38D11/S	1	2.69	48	4.0 x 4.0 x 1.2	shielded drum core
Coilcraft	LPS4012-102NLC	1	2.5	60	4.1 x 4.1 x 1.2	shielded drum core

Table 4: Typical Suggested Surface Mount Inductors.

Manufacturer	Part Number	Capacitance (μ F)	Voltage Rating (V)	Temp Co.	Case Size
Murata	GRM185R60J225KE26	2.2	6.3	X5R	0603
Murata	GRM188R71A225KE15	2.2	10	X7R	0603
Murata	GRM21BR70J225KA01	2.2	6.3	X7R	0805
Murata	GRM21BR71A225KA01	2.2	10	X7R	0805
Murata	GRM219R61A475KE19	4.7	10	X5R	0805
Murata	GRM21BR71A106KE51	10	10	X7R	0805

Table 5: Typical Suggested Surface Mount Capacitors.

AAT1274

1.5A Single Flash LED Driver IC

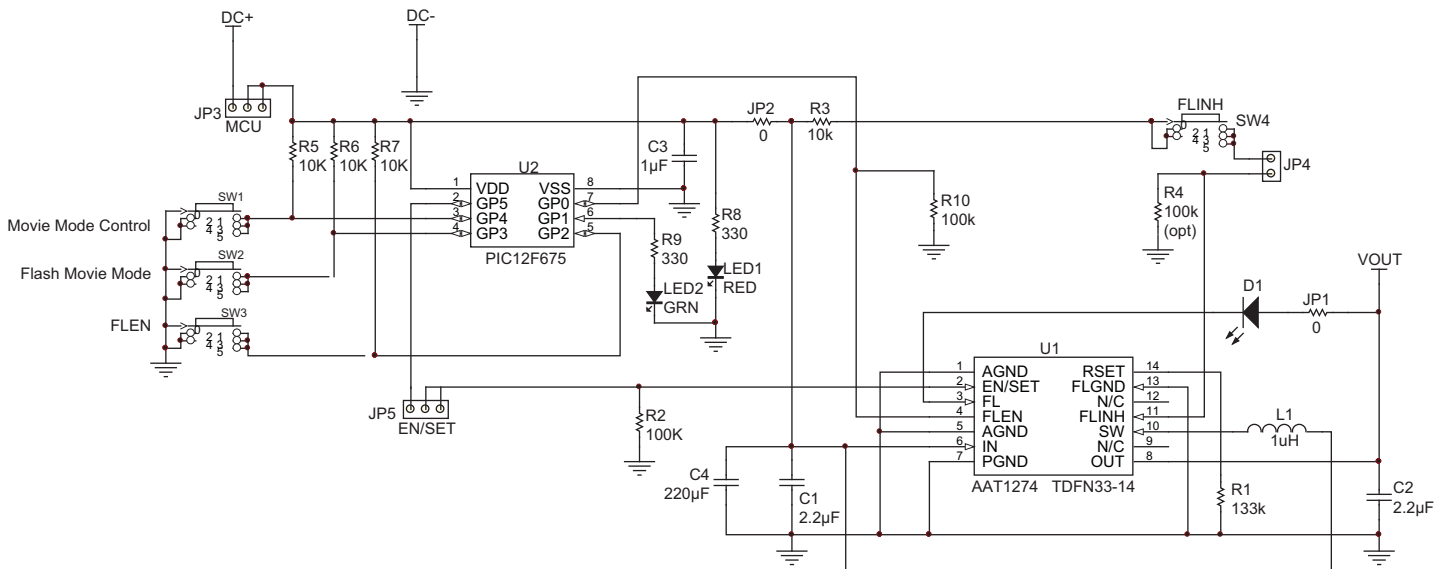

- L1 CooperBussmann SD3812-1R0-R, 1µH, 2.69A, 48mΩ
- C1, C2 Murata GRM188R71A225KE15 2.2µF, 0603, X7R, 10V
- D1 Lumiled LXCL-PWF4 or equivalent

Figure 2: AAT1274 Evaluation Board Schematic.

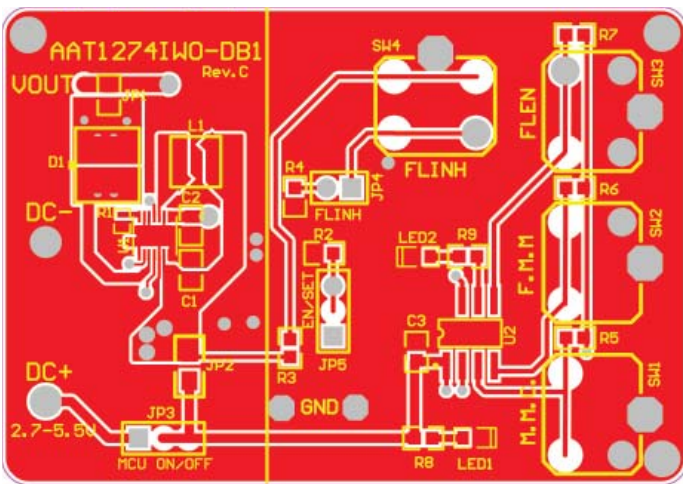

Figure 3: AAT1274 Evaluation Board Top Side Layout.

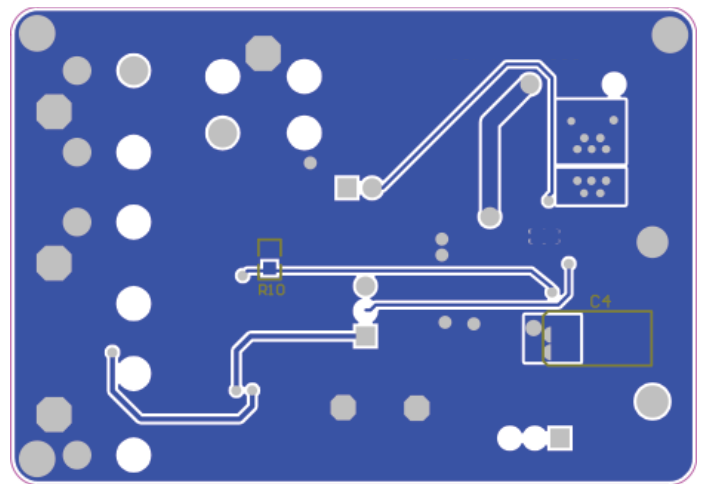

Figure 4: AAT1274 Evaluation Board Bottom Side Layout.

AAT1274***1.5A Single Flash LED Driver IC***

Component	Part Number	Description	Manufacturer
U1	AAT1274IWO	1.5A Step-Up Current Regulator for Flash LED; TDFN33-14 package	Skyworks
U2	PIC12F675	8-bit CMOS, FLASH-based μ C; 8-pin SOIC package	Microchip
SW1 – SW4	PTS645TL50	Switch Tact, SPST, 5mm	ITT Industries
R1	Chip Resistor	133k Ω , 1%, 1/4W; 0402	Vishay
R2, R4, R10	Chip Resistor	100k Ω , 1%, 1/4W; 0603	Vishay
R3, R5, R6, R7	Chip Resistor	10k Ω , 5%, 1/4W; 0603	Vishay
R8, R9	Chip Resistor	330 Ω , 5%, 1/4W; 0603	Vishay
JP1, JP2	Chip Resistor	0 Ω , 5%	Vishay
C1, C2	GRM188R71A225KE15	2.2 μ F, 10V, X7R, 0603	MuRata
C3	GRM216R61A105KA01	1 μ F, 10V, X5R, 0805	MuRata
L1	SD3812-1R0-R	Drum Core, 1 μ H, 2.69A, 48m Ω	Cooper Bussmann
D1	FCW401Z4	White Flash LED	Seoul Semiconductor
LED1	CMD15-21SRC/TR8	Red LED; 1206	Chicago Miniature Lamp
LED2	CMD15-21VGC/TR8	Green LED; 1206	Chicago Miniature Lamp
JP3, JP4, JP5	PRPN401PAEN	Conn. Header, 2mm zip	Sullins Electronics

Table 6: AAT1274 Evaluation Board Bill of Materials.

Ordering Information

Package	Marking ¹	Part Number(Tape and Reel) ²
TDFN33-14	B1XYY	AAT1274IWO-T1

 Skyworks Green™ products are compliant with all applicable legislation and are halogen-free. For additional information, refer to *Skyworks Definition of Green™*, document number SQ04-0074.

Package Information

TDFN33-14

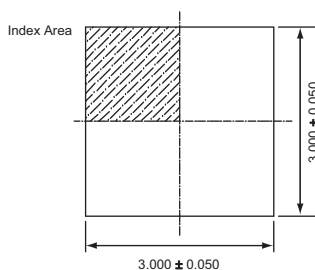

Top View

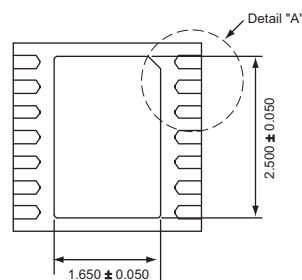

Bottom View

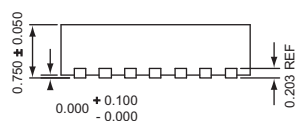

Side View

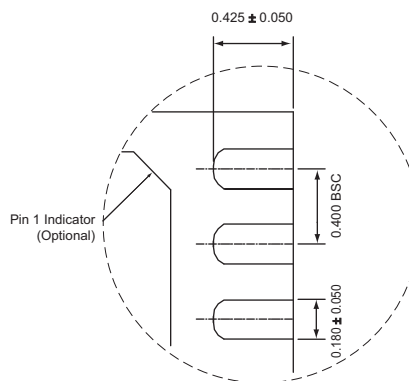

Detail "A"

1. XYY = assembly and date code.
2. Sample stock is generally held on part numbers listed in **BOLD**.
3. The leadless package family, which includes QFN, TQFN, DFN, TDFN, and STDFN, has exposed copper (unplated) at the end of the lead terminals due to the manufacturing process. A solder fillet at the exposed copper edge cannot be guaranteed and is not required to ensure a proper bottom solder connection.

Copyright © 2012 Skyworks Solutions, Inc. All Rights Reserved.

Information in this document is provided in connection with Skyworks Solutions, Inc. ("Skyworks") products or services. These materials, including the information contained herein, are provided by Skyworks as a service to its customers and may be used for informational purposes only by the customer. Skyworks assumes no responsibility for errors or omissions in these materials or the information contained herein. Skyworks may change its documentation, products, services, specifications or product descriptions at any time, without notice. Skyworks makes no commitment to update the materials or information and shall have no responsibility whatsoever for conflicts, incompatibilities, or other difficulties arising from any future changes.

No license, whether express, implied, by estoppel or otherwise, is granted to any intellectual property rights by this document. Skyworks assumes no liability for any materials, products or information provided hereunder, including the sale, distribution, reproduction or use of Skyworks products, information or materials, except as may be provided in Skyworks Terms and Conditions of Sale.

THE MATERIALS, PRODUCTS AND INFORMATION ARE PROVIDED "AS IS" WITHOUT WARRANTY OF ANY KIND, WHETHER EXPRESS, IMPLIED, STATUTORY, OR OTHERWISE, INCLUDING FITNESS FOR A PARTICULAR PURPOSE OR USE, MERCHANTABILITY, PERFORMANCE, QUALITY OR NON-INFRINGEMENT OF ANY INTELLECTUAL PROPERTY RIGHT; ALL SUCH WARRANTIES ARE HEREBY EXPRESSLY DISCLAIMED. SKYWORKS DOES NOT WARRANT THE ACCURACY OR COMPLETENESS OF THE INFORMATION, TEXT, GRAPHICS OR OTHER ITEMS CONTAINED WITHIN THESE MATERIALS. SKYWORKS SHALL NOT BE LIABLE FOR ANY DAMAGES, INCLUDING BUT NOT LIMITED TO ANY SPECIAL, INDIRECT, INCIDENTAL, STATUTORY, OR CONSEQUENTIAL DAMAGES, INCLUDING WITHOUT LIMITATION, LOST REVENUES OR LOST PROFITS THAT MAY RESULT FROM THE USE OF THE MATERIALS OR INFORMATION, WHETHER OR NOT THE RECIPIENT OF MATERIALS HAS BEEN ADVISED OF THE POSSIBILITY OF SUCH DAMAGE.



Skyworks products are not intended for use in medical, lifesaving or life-sustaining applications, or other equipment in which the failure of the Skyworks products could lead to personal injury, death, physical or environmental damage. Skyworks customers using or selling Skyworks products for use in such applications do so at their own risk and agree to fully indemnify Skyworks for any damages resulting from such improper use or sale.

Customers are responsible for their products and applications using Skyworks products, which may deviate from published specifications as a result of design defects, errors, or operation of products outside of published parameters or design specifications. Customers should include design and operating safeguards to minimize these and other risks. Skyworks assumes no liability for applications assistance, customer product design, or damage to any equipment resulting from the use of Skyworks products outside of stated published specifications or parameters.

Skyworks, the Skyworks symbol, and "Breakthrough Simplicity" are trademarks or registered trademarks of Skyworks Solutions, Inc., in the United States and other countries. Third-party brands and names are for identification purposes only, and are the property of their respective owners. Additional information, including relevant terms and conditions, posted at www.skyworksinc.com, are incorporated by reference.

Looking for pricing, stock, or lifecycle information?

Click below to explore more details on WIN SOURCE:

-  [View AAT1274IWO-T1 on WIN SOURCE](#)
-  [Skyworks Solutions Inc. Information](#)

Optimize Your Supply Chain with WIN SOURCE Solutions

-  Global Sourcing Solution
-  Obsolete Management
-  Cost Control Management
-  Shortage Management
-  Alternative Solution
-  Excess Inventory Management