



THE DATASHEET OF
AAT1272IWO-T1



1.5A Step-Up Current Regulator for Flash LEDs**General Description**

The AAT1272 is a high-efficiency, high-current boost converter capable of 1.5A typical output current. It is an ideal power solution for LED photo flash applications in all single cell Li-ion powered products.

The AAT1272 maintains output current regulation by switching the internal high-side and low-side switch transistors. The transistor switches are pulse-width modulated at a fixed frequency of 2MHz. The high switching frequency allows the use of a small inductor and output capacitor, making the AAT1272 ideally suited for small battery-powered applications.

An industry-standard I²C serial digital input is used to enable, disable and set the movie-mode current for each flash LED with up to 16 movie-mode settings. The AAT1272 also includes a separate Flash Enable input to initiate both the flash operation and the default timer, which can be used either to terminate a flash event at the end of a user-programmed delay or as a safety feature. The maximum flash and movie-mode current is set by one external resistor; the ratio of Flash to Movie-mode current is set at approximately 7.3:1. One or two LEDs can be connected to the AAT1272; in the case of two LEDs the output current is matched between each diode.

The AAT1272 contains a thermal management system to protect the device in the event of an output short-circuit condition. Built-in circuitry prevents excessive inrush current during start-up. The shutdown feature reduces quiescent current to less than 1.0 μ A.

The AAT1272 is available in a Pb-free, thermally-enhanced 14-pin 3x3mm TDFN package.

Features

- V_{IN} Range: 2.7V to 5.5V
- Dual Channel Output
- Up to 1.5A Regulated Output Current (750mA per channel)
- Up to 85% Efficiency with Small Inductor (1 μ H)
- 2 MHz Switching Frequency
- Separate Flash Enable
- User-Programmable Safety Timer
- Single Resistor Sets Flash and Movie Mode Current
- Two Wire, I²C Compliant Serial Interface
 - Fast, 400kHz Serial Transfer Rate
 - 16 Level Movie-mode Current
 - Flash/Movie-mode
 - Current Output Channel Control
 - Safety Timer
- True Load Disconnect
- Input Current Limit
- Over-Voltage (Open LED, Open Circuit), Short Circuit, and Over-Temperature Protection
- Shutdown Current < 1.0 μ A
- 14-pin TDFN 3x3 mm Package
- -40°C to +85°C Temperature Range

Applications

- Digital Still Cameras (DSCs)
- LED Photo Flash/Torch
- Mobile Handsets
- MP3 Players
- PDAs and Notebook PCs

1.5A Step-Up Current Regulator for Flash LEDs

Typical Application

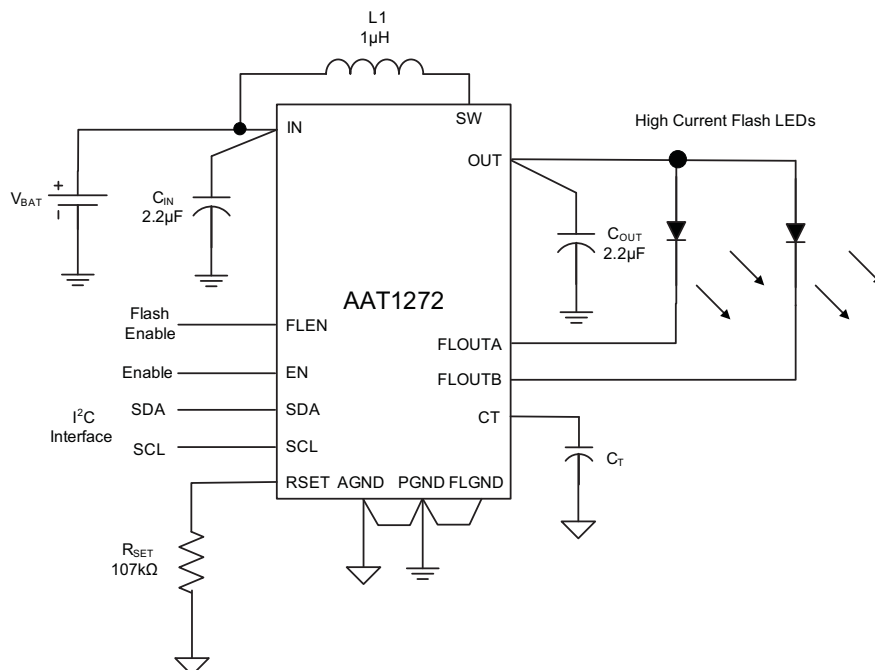

Pin Descriptions

Pin #	Symbol	Function
1	CT	Flash timer control input. Connect a capacitor between CT and AGND to set maximum duration of the flash pulse. To disable the flash timer, connect CT to AGND.
2	EN	Enable input. EN is an active HIGH asserted input. EN must be strobed low-to-high to enable the AAT1272 to accept I ² C programming instructions.
3	FLEN	Flash enable pin. A low-to-high transition on the FLEN pin initiates a flash pulse and starts the flash timer.
4	AGND	Analog ground pin. Connect AGND to PGND, GND, and FLGND at a single point as close to the AAT1272 as possible.
5	IN	Power input. Connect IN to the input power supply voltage. Connect a 2.2µF or larger ceramic capacitor from IN to PGND as close as possible to the AAT1272
6	SW	Boost converter switching node. Connect a 1µH inductor between SW and IN.
7	PGND	Power ground pin. Connect PGND to AGND, GND, and FLGND at a single point as close to the AAT1272 as possible.
8	OUT	Power output of the boost converter. Connect a 2.2µF or larger ceramic capacitor from OUT to PGND as close as possible to the AAT1272. Connect OUT to the anode(s) of the Flash LED(s).
9	SCL	I ² C interface serial control line.
10	SDA	I ² C interface serial data/address.
11	FLOUTB	Flash Output B. Connect cathode of Flash LEDB to FLOUTB. For a single flash LED, connect FLOUTB and FLOUTA together. For two flash LEDs, each output will conduct 50% of the total flash output current.
12	FLGND	Flash ground pin. Connect FLGND to PGND, GND, and AGND at a single point as close to the AAT1272 as possible.
13	FLOUTA	Flash Output A. Connect cathode of Flash LEDA to FLOUTA. For a single flash LED, connect FLOUTA and FLOUTB together. For two flash LEDs, each output will conduct 50% of the total flash output current.
14	RSET	Flash current setting input. A 107kΩ resistor from RSET to AGND sets the maximum flash current available at FLOUTA and FLOUTB to 1.5A. Each FLOUTA and FLOUTB channel will conduct 50% of the maximum programmed current. The AAT1272's flash-to-movie-mode ratio is fixed at 7.3:1.
EP		Exposed paddle (bottom); Connect EP to PGND as close as possible to the AAT1272.

1.5A Step-Up Current Regulator for Flash LEDs

Pin Configuration

**TDFN33-14
 (Top View)**

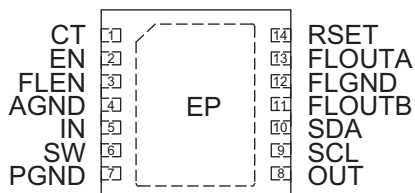

Absolute Maximum Ratings¹

(T_A = 25°C unless otherwise noted.)

Symbol	Description	Value	Units
IN, SW, OUT	Maximum Rating	-0.3 to 6.0	V
RSET, EN/SET, FLEN, FLINH, CT, FLOUTA, FLOUTB	Maximum Rating	V _{IN} + 0.3	V
T _J	Operating Temperature Range	-40 to 150	°C
T _s	Storage Temperature Range	-65 to 150	°C
T _{LEAD}	Maximum Soldering Temperature (at leads, 10 sec)	300	°C

Recommended Operating Conditions

Symbol	Description	Value	Units
θ _{JA}	Thermal Resistance	50	°C/W
P _D	Maximum Power Dissipation	2	W

1. Stresses above those listed in Absolute Maximum Ratings may cause permanent damage to the device. Functional operation at conditions other than the operating conditions specified is not implied. Only one Absolute Maximum Rating should be applied at any one time. The AAT1272 is guaranteed to meet performance specifications over the -40°C to +85°C operating temperature range and is assured by design, characterization, and correlation with statistical process controls.

1.5A Step-Up Current Regulator for Flash LEDs

Electrical Characteristics¹

$V_{IN} = 3.6V$; $C_{IN} = 2.2\mu F$; $C_{OUT} = 2.2\mu F$; $L = 1\mu H$; $R_{SET} = 107k\Omega$; $T_A = -40^\circ C$ to $85^\circ C$, unless otherwise noted. Typical values are $T_A = 25^\circ C$.

Symbol	Description	Conditions	Min	Typ	Max	Units
Power Supply						
V_{IN}	Input Voltage Range		2.7		5.5	V
$V_{OUT(MAX)}$	Maximum Output Voltage				5.5	V
$I_{IN(Q)}$	Supply Current	EN = FLEN = IN, Set FL Load = 1.5A		0.67	1	mA
		EN = IN, FLEN = AGND		0.23		
$I_{SHDN(MAX)}$	V_{IN} Shutdown Current	EN = FLEN = GND			1	μA
$I_{FL(TOTAL)}$	Total Output Current, Flash Mode	$R_{SET} = 107k\Omega$; FLOUTA + FLOUTB	1.2	1.5		A
$I_{FL(MATCH)}$	FLOUTA and FLOUTB Current Matching			10		%
$I_{MM(LOAD)}$	Total Output Current, Movie Mode	$R_{SET} = 107k\Omega$, Movie Mode Current Set = 100%; FLOUTA + FLOUTB		206		mA
f_{OSC}	Switching Frequency	$T_A = 25^\circ C$	1.5	2.0	2.5	MHz
$t_{DEFAULT}$	Default ON Time	$C_T = 74nF$		600		ms
T_{SD}	Thermal Shutdown Threshold			140		$^\circ C$
$T_{SD(HYS)}$	Thermal Shutdown Hysteresis			15		$^\circ C$
I²C Control – SDA, SCL						
V_{IL}	Input Threshold Low				0.4	V
V_{IH}	Input Threshold High		1.4			V
I_I	Input Current		-1.0		1.0	μA
V_{OL}	Output Logic Low (SDA)	$I_{PULLUP} = 3mA$			0.4	V
f_{SCL}	SCL Clock Frequency		0		400	kHz
t_{LOW}	SCL Clock Low Period		1.3			μs
t_{HIGH}	SCL Clock High Period		0.6			μs
t_{HD_STA}	Hold Time START Condition		0.6			μs
t_{SU_STA}	Setup Time for Repeat START		0.6			μs
t_{SU_DAT}	SDA Data Setup Time		100			ns
t_{HD_DAT}	SDA Data Hold Time				0.9	μs
t_{SU_STO}	Setup time for STOP Condition		0.6			μs
t_{BUF}	Bus Free Time between STOP and START Condition		1.3			μs
EN, FLEN Logic Control						
$V_{EN(L)}$, $V_{FLEN(L)}$	EN, FLEN Input Low Threshold				0.4	V
$V_{EN(H)}$, $V_{FLEN(H)}$	EN, FLEN Input High Threshold		1.4			V
t_{FLEN_OND}	FLEN ON Delay Time	EN = AGND		40		μs
t_{FLEN_OFFD}	FLEN OFF Delay Time	EN = AGND		10		μs

1. The AAT1272 is guaranteed to meet performance specifications over the $-40^\circ C$ to $+85^\circ C$ operating temperature range and is assured by design, characterization, and correlation with statistical process controls.

1.5A Step-Up Current Regulator for Flash LEDs

I²C Interface Timing Details

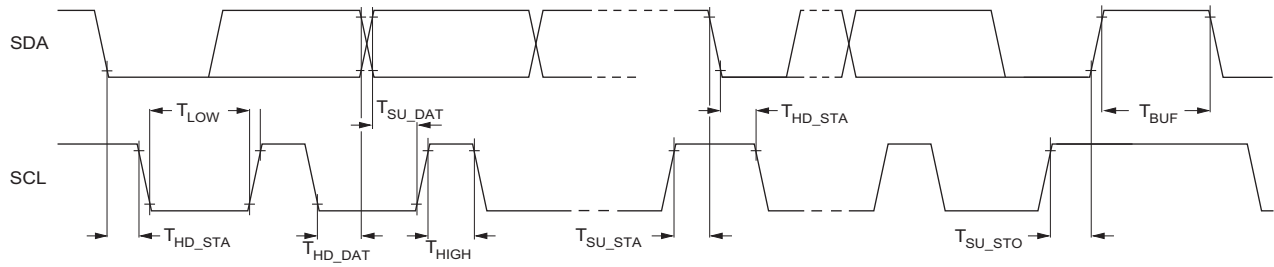

1.5A Step-Up Current Regulator for Flash LEDs

Typical Characteristics

Flash Mode Efficiency vs. Input Voltage

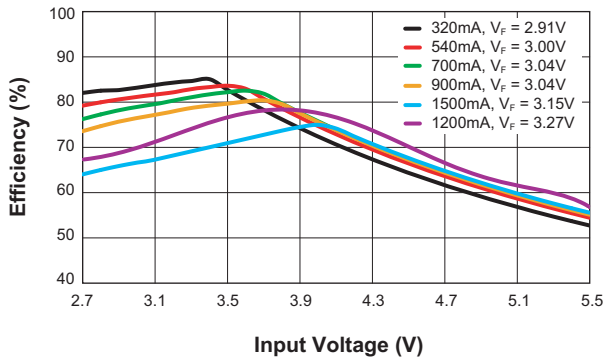

Movie Mode Efficiency vs. Input Voltage

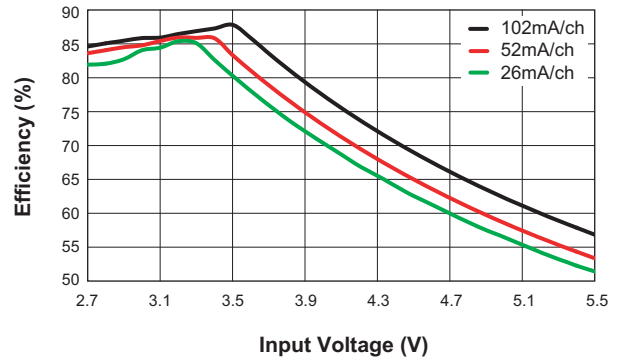

Boost Switching Frequency vs. Input Voltage (Movie Mode; L = 1μH)

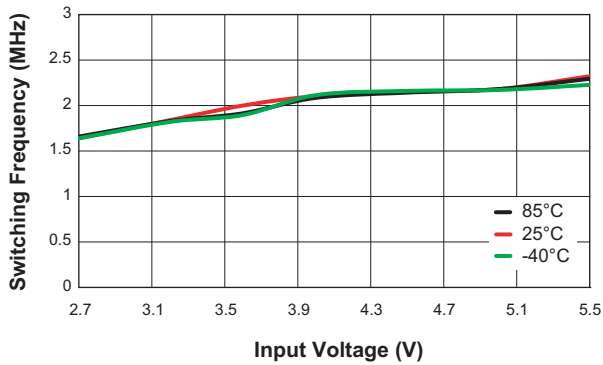

Shutdown Current vs. Input Voltage (V_{EN/SET} = V_{FLEN} = 0V)

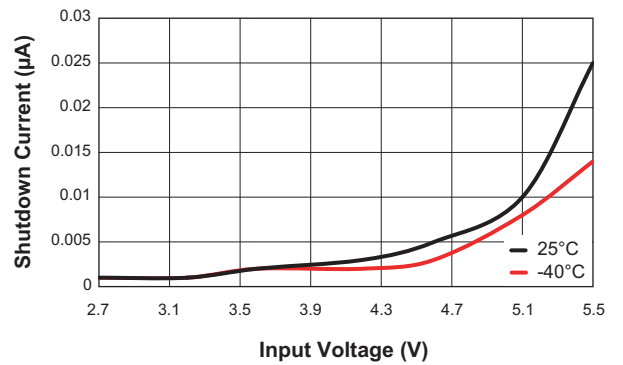

Supply Current vs. Input Voltage (V_{EN} = V_{FLEN} = 3.6V)

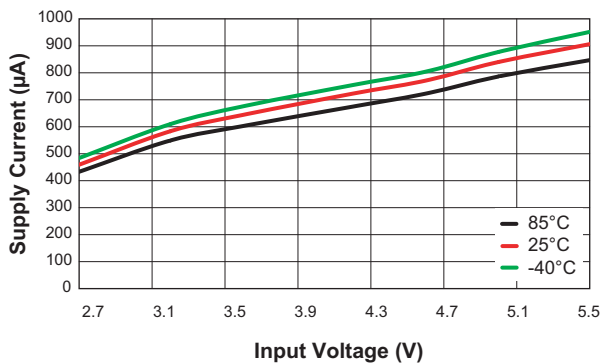

Movie Mode Current vs. Temperature (I_{FLOUTX} = 103mA/Ch; V_{IN} = 3.6V; L = 1μH)

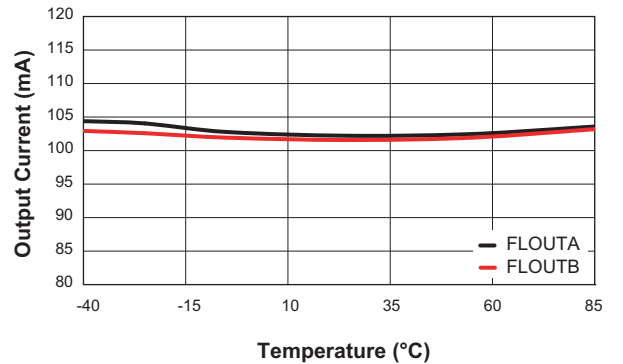

1.5A Step-Up Current Regulator for Flash LEDs

Typical Characteristics

Movie Mode LED Current Accuracy vs. Input Voltage
($I_{FLOUTX} = 103\text{mA/Channel}$; $L = 1\mu\text{H}$)

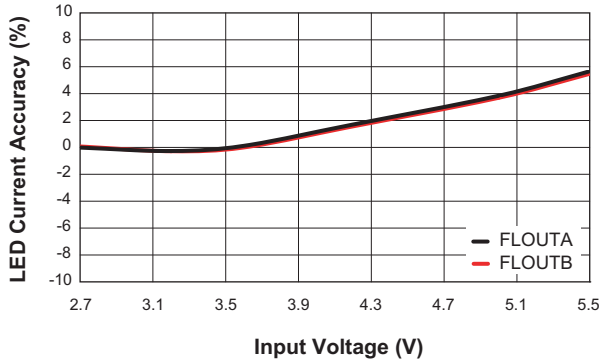

Movie Mode Output Ripple
($I_{FLOUTX} = 103\text{mA/ch}$; $V_{IN} = 3.6\text{V}$; $L = 1\mu\text{H}$)

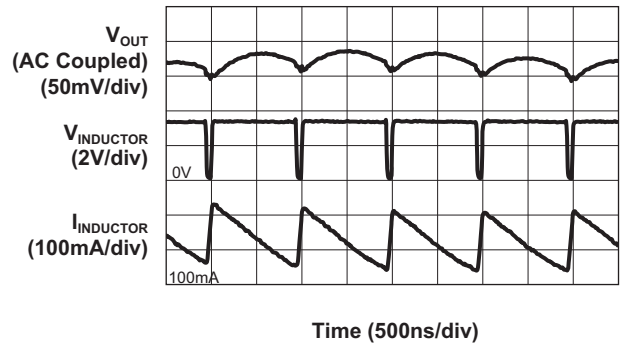

Flash Mode Output Ripple
($I_{FLOUTX} = 750\text{mA/ch}$; $V_{IN} = 4\text{V}$; $L = 1\mu\text{H}$)

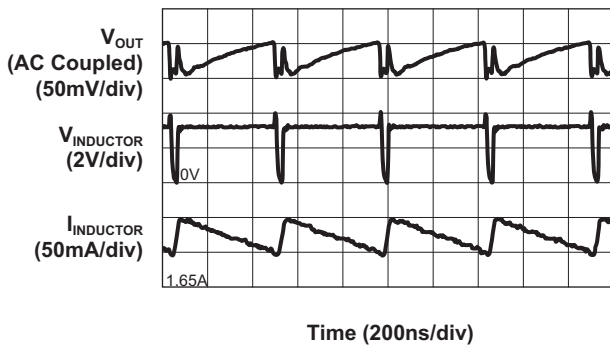

Flash LED Current Matching vs. Temperature
($I_{FLOUTX} = 750\text{mA/Ch}$; $V_{IN} = 4.2\text{V}$; $L = 1\mu\text{H}$)

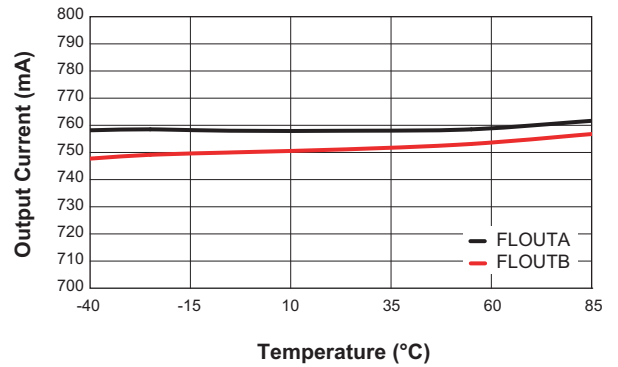

Flash On Time Delay vs. Input Voltage
($I_{FLOUTX} = 750\text{mA/ch}$; $C_{OUT} = 2.2\mu\text{F}$; $L = 1\mu\text{H}$)

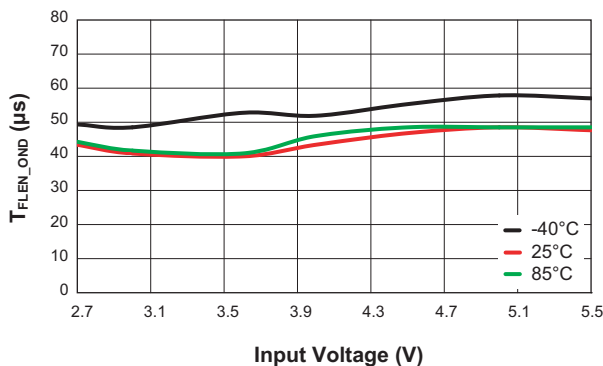

Flash Timeout Delay vs. C_T Capacitor
($I_{FLOUTX} = 750\text{mA/ch}$; $V_{IN} = 3.6\text{V}$)

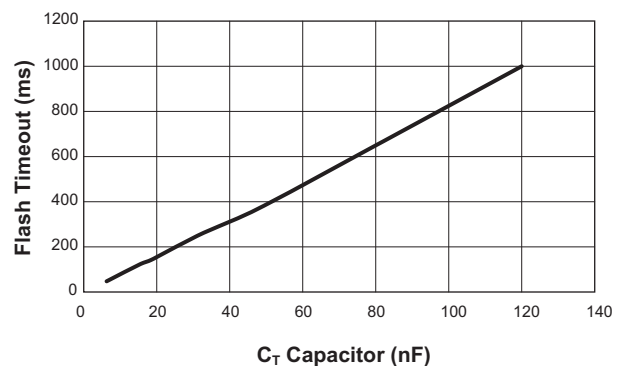

1.5A Step-Up Current Regulator for Flash LEDs

Typical Characteristics

Movie Mode Line Transient
 ($I_{FLOUTX} = 103\text{mA/ch}$; $V_{IN} = 4.2\text{V to } 3.6\text{V}$)

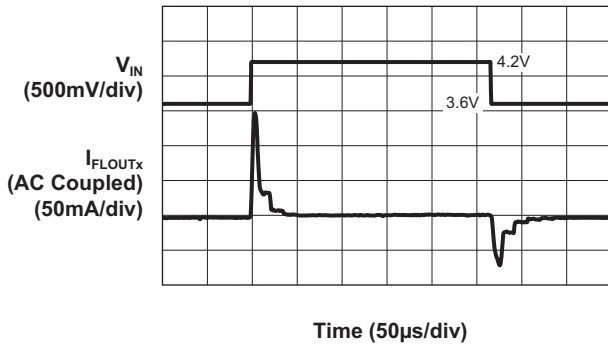

Flash Turn On Characteristic
 ($I_{FLOUTX} = 750\text{mA/ch}$; $V_{IN} = 3.6\text{V}$; $L = 1\mu\text{H}$)

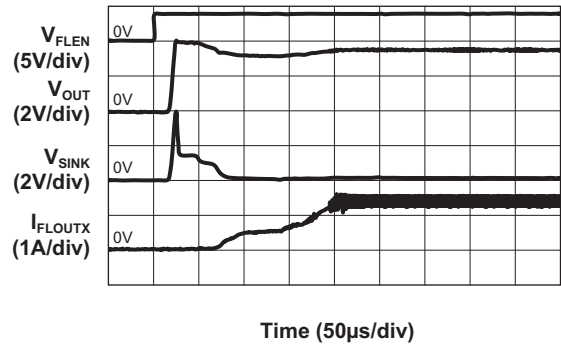

Movie Mode to Flash Turn On Characteristic
 ($I_{FLOUTX} = 103\text{mA to } 750\text{mA/ch}$; $V_{IN} = 3.6\text{V}$; $L = 1\mu\text{H}$)

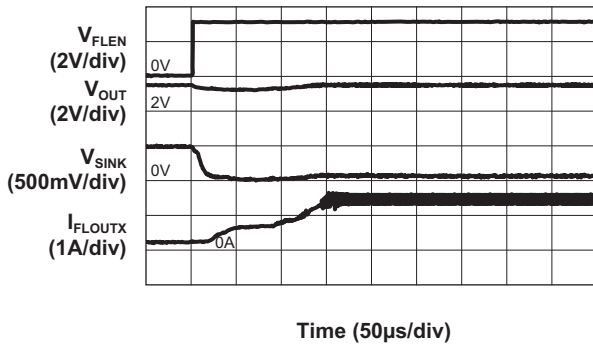

Movie Mode Turn On Characteristic
 ($I_{FLOUTX} = 103\text{mA/ch}$; $V_{IN} = 3.6\text{V}$; $L = 1\mu\text{H}$)

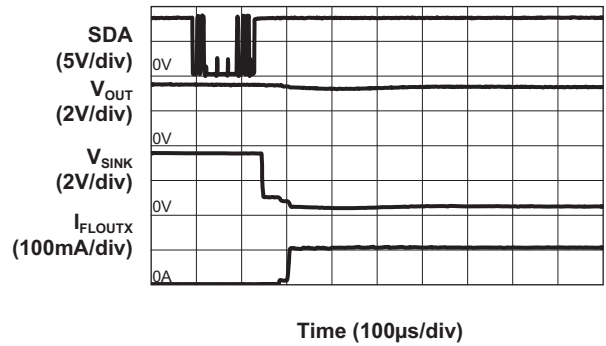

Movie Mode Transition Characteristic
 ($I_{FLOUTX} = 102\text{mA to } 188\text{mA/ch}$; $C_{OUT} = 0.22\mu\text{F}$;
 $V_{IN} = 3.6\text{V}$; $L = 1\mu\text{H}$)

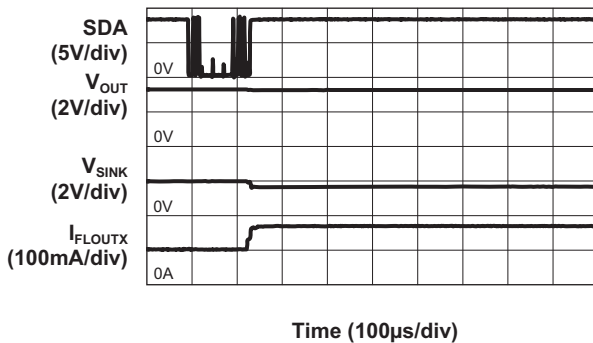

Flash Timeout vs. Temperature
 ($I_{FLOUTX} = 750\text{mA/ch}$; $V_{IN} = 3.6\text{V}$; $C_T = 47\text{nF}$)

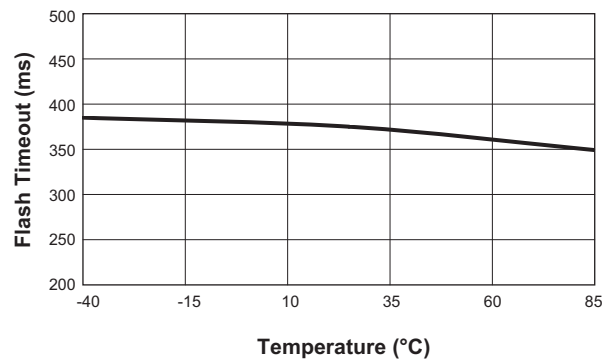

1.5A Step-Up Current Regulator for Flash LEDs

Typical Characteristics

EN, FLEN High Threshold Voltage vs. Input Voltage

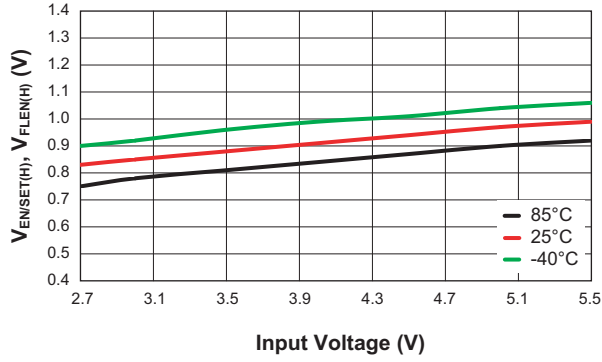

EN, FLEN Low Threshold Voltage vs. Input Voltage

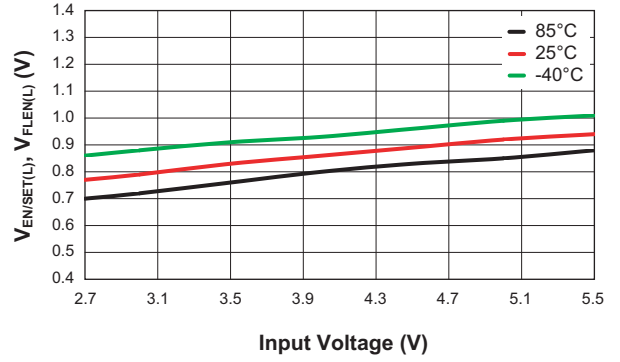

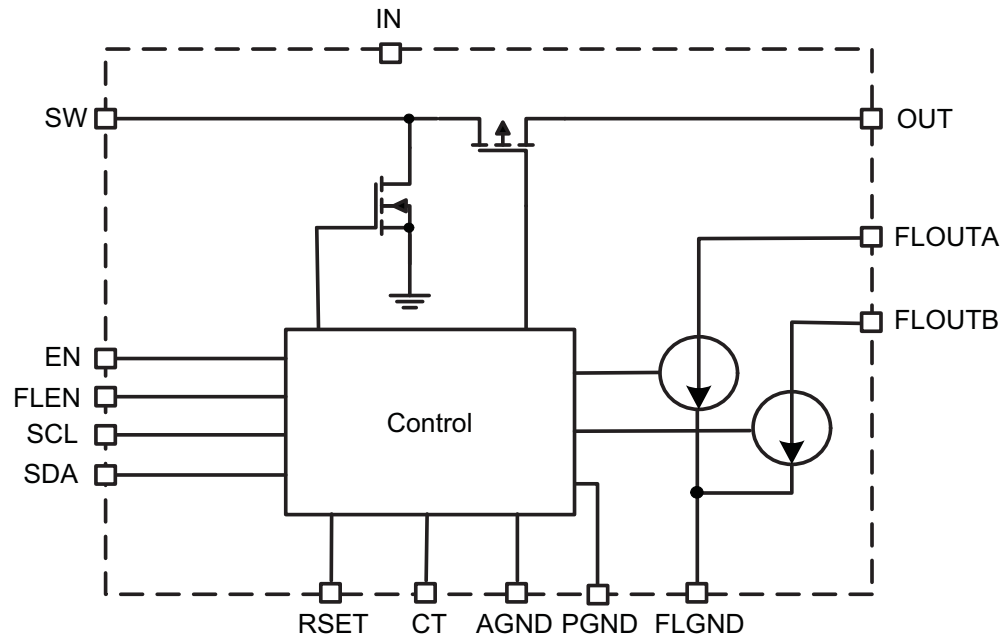
Functional Block Diagram**Functional Description**

The AAT1272 is a boost converter with a current-regulated output designed to drive high current white LEDs used in camera flash applications. The maximum flash current is set by an external resistor, R_{SET} , which sets the flash current and the maximum movie-mode current. The maximum movie-mode current is equal to the maximum programmed flash current minus the programmed flash-to-movie-mode ratio whose default value is 7.3.

A flash pulse is initiated by strobing the FLEN input pin low-to-high, which initiates a flash pulse and also starts the internal timer. The maximum flash current in the AAT1272 is set by an external resistor, R_{SET} , which sets the flash current and the maximum movie-mode current reduced by a factor of 2. The flash timer will terminate the flash current regardless of the status of the FLEN pin. This can be either used as a simple flash timing pulse or can be used as a safety timer in the event of a control logic malfunction to prevent the LED from over-heating.

The maximum flash time is determined by an external timing capacitor connected to the CT pin. The flash duration can be set from 50ms up to a maximum of 1s. The

I²C-compliant interface allows further adjustment of the flash timer duration. This allows the flash timer duration to be reduced in 16 linear steps from the maximum time set by the timing capacitor. If the safety timer is not needed in the application, it can be disabled by connecting the CT pin directly to AGND.

The AAT1272 has two LED current sources which share the output current equally. For a single white LED application, the two current sources can be connected together to apply full output current into the LED. In two LED applications, each diode can be connected to its corresponding current source (FLOUTA or FLOUTB) and the output current will be shared. In applications where only one LED is connected to either FLOUTA or FLOUTB, the unused current sink must be directly connected to OUT, thereby disabling that channel.

Movie Mode

The movie mode current level, the flash safety timer, the output channel enable, and the flash-to-movie mode current ratio can be set using the AAT1272's I²C-compliant interface. The movie-mode current level can be adjusted in 16 steps using a logarithmic scale where

1.5A Step-Up Current Regulator for Flash LEDs

each code is 1dB below the previous code. The flash safety delay can be reduced from the maximum value programmed externally by C_T in 16 linear steps. The flash current outputs FLOUTA and FLOUTB can be enabled or disabled individually or together. The flash-to-movie-mode current ratio can be set from 1:2 to 1:30 with respect to the maximum programmed flash current. The FLEN signal takes priority over movie-mode operation. Lastly, the EN pin must be toggled low-to-high to enable the AAT1272 to accept I²C programming instructions.

Over-Temperature Protection

Thermal protection disables the AAT1272 when internal power dissipation becomes excessive, as it disables both MOSFETs. The junction over-temperature threshold is 140°C with 15°C of temperature hysteresis. The output voltage automatically recovers when the over-temperature fault condition is removed.

Over-Voltage Protection (Open LED, Open Circuit)

The AAT1272's output voltage is limited by internal over-voltage protection circuitry, which prevents damage to the AAT1272 from open LED or open circuit conditions. During an open circuit, the output voltage rises and reaches 5.5V (typical), and the OVP circuit disables the switching, preventing the output voltage from rising higher. Once the open circuit condition is removed, switching will resume. The controller will return to normal operation and maintain an average output voltage.

Auto-Disable Feature

The AAT1272 is equipped with an auto-disable feature for each LED channel. After the IC is enabled and started up, a test current of 2-3mA (typical) is forced through each sink channel. The channel will be disabled if the voltage of that particular SINK pin does not drop to a certain threshold. This feature is very convenient for disabling an unused channel or during an LED fail-short event. This small test current should be added to the set output current in both Flash and MM conditions.

Applications Information

LED Selection

The AAT1272 is specifically designed to drive white flash LEDs (typical forward voltage of 2.5V to 4.0V). Since the FLOUTA and FLOUTB input current sinks are matched with low voltage dependence; the LED-to-LED brightness will be matched regardless of the individual LED forward voltage (V_f) levels.

Flash Mode LED Current

The LED current is controlled by the RSET resistor. For maximum accuracy, a 1% tolerance resistor is recommended. FLOUTA and FLOUTB can be programmed up to a maximum total flash current of 1.5A or up to 750mA per channel. FLOUTA and FLOUTB output current is matched across the programming range. A flash event is initiated by asserting the FLEN pin. A flash event is automatically terminated when FLEN is disabled or if the safety timer terminates before the FLEN pin is disabled.

The maximum flash current in each FLOUTA and FLOUTB is set by the R_{SET} resistor and can be calculated using the following equation:

$$I_{FLOUTA} = I_{FLOUTB} = \frac{81k\Omega \cdot A}{R_{SET}} = \frac{81k\Omega \cdot A}{107k\Omega} = \sim 750mA \text{ per channel}$$

To prevent excessive power dissipation during higher flash current operation, R_{SET} values smaller than 107k Ω are not recommended.

Movie Mode LED Current

The maximum movie-mode current level is set by the maximum, programmed flash current reduced by the programmed flash-to-movie-mode ratio in which the default value is 7.3:

$$I_{MOVIE-MODE[A/B]} = \frac{I_{FLOUT[A/B](MAX)}}{7.3} = \frac{750mA}{7.3} = 103mA$$

To change the configuration or the settings, the AAT1272 can be programmed via the I²C interface. Triggering the FLEN low to high will enable a flash event with the maximum flash current set by the R_{SET} resistor or with programmed flash current set via the I²C interface. Concurrently, the flash timer is also initiated. All data and register contents are cleared (reset to the default value) after each flash event.

1.5A Step-Up Current Regulator for Flash LEDs

Flash Safety Timeout

The AAT1272 includes a timer circuit that enables the flash current for a programmed period of time. This feature eliminates the need for an external, housekeeping baseband controller to contain a safety delay routine. It also serves as a protection feature to minimize thermal issues with the flash LEDs in the event an external controller's flash software routine experiences hang-up or freeze. The flash safety timeout, T can be calculated by the following equation:

$$T = 7.98\text{s}/\mu\text{F} \cdot C_T$$

Where T is in seconds and C_T is the capacitance of the timer capacitor in μF .

For example, using a 47nF capacitor for C_T sets the flash timeout to:

$$\text{Flash Safety Timeout} = 7.98\text{s}/\mu\text{F} \cdot 0.047\mu\text{F} = 375\text{ms}$$

The relationship between the flash safety timeout and the capacitance of the timer capacitor is illustrated in Figure 1.

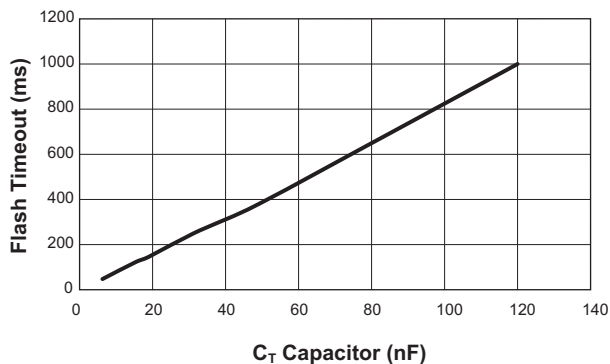

Figure 1: Flash Safety Timeout vs. Timer Capacitor.

I²C Serial Interface

The AAT1272 is fully compliant with the industry-standard I²C interface. The I²C two-wire communications bus consists of SDA and SCL lines. SDA provides data, while SCL provides clock synchronization with speed up to 400kHz. SDA data transfers device address followed by a register address and data bits sequence. When using the I²C interface, EN is pulled high to enable the device or low to disable the device. The I²C serial interface

requires a master to initiate all the communications with target devices. The AAT1272 is a target device and only supports the write protocol. The AAT1272 is manufactured with a target device address of 0x37 (Hex). See Figure 2 for the I²C interface diagram.

I²C START and STOP Conditions

START and STOP conditions are always generated by the master. Prior to initiating a START, both the SDA and SCL pins are in idle mode (idle mode is when there is no activity on the bus and SDA and SCL are pulled high by the external pull-up resistors). A START condition occurs when the master strobes the SDA line low and after a short period strobes the SCL line low. A START condition acts as a signal to all ICs that transmission activity is about to occur on the I²C bus. A STOP condition, as shown in Figure 2, is when master releases the bus and SCL changes from low to high followed by SDA low-to-high transition. The master does not issue an ACKNOWLEDGE and releases the SCL and SDA pins.

I²C Address Bit Map

Figure 4 illustrates the address bit transfer. The 7-bit address is transferred with the Most Significant Bit (MSB) first and is valid when SCL is high. This is followed by the R/W bit in the Least Significant Bit (LSB) location. The R/W bit on the eighth bit determines the direction of the transfer (a '1' for read or a '0' for write). The AAT1272 is a write-only device and the R/W bit must be set low. The Acknowledge bit (ACK) is set to low by the AAT1272 to acknowledge receipt of the address.

I²C Register Address/Data Bit Map

Figure 5 illustrates the Register Address or the serial data bit transfer. The 8-bit data is always transferred most significant bit first and is valid when SCL is high. The Acknowledge bit (ACK) is set low by the AAT1272 to acknowledge receipt of the register address or the data.

I²C Acknowledge Bit (ACK)

The Acknowledge bit is the ninth bit of each transfer on the SDA line. It is used to send back a confirmation to the master that the data has been received properly by the target device. For each ACK to take place, the master must first release the SDA line, and then the target device will pull the SDA line low, as shown in Figures 1, 4, and 5.

1.5A Step-Up Current Regulator for Flash LEDs

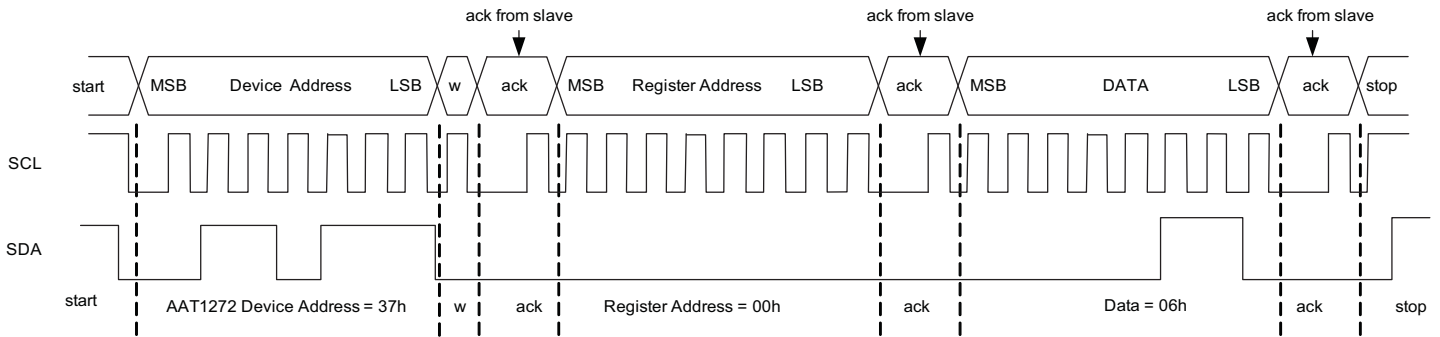

Figure 2: I²C Interface Diagram.

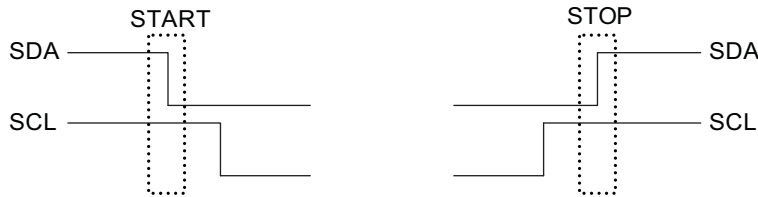
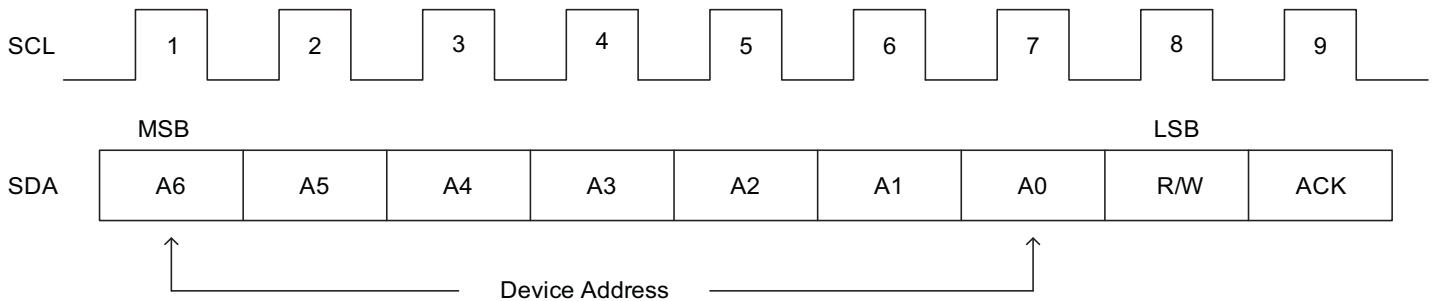
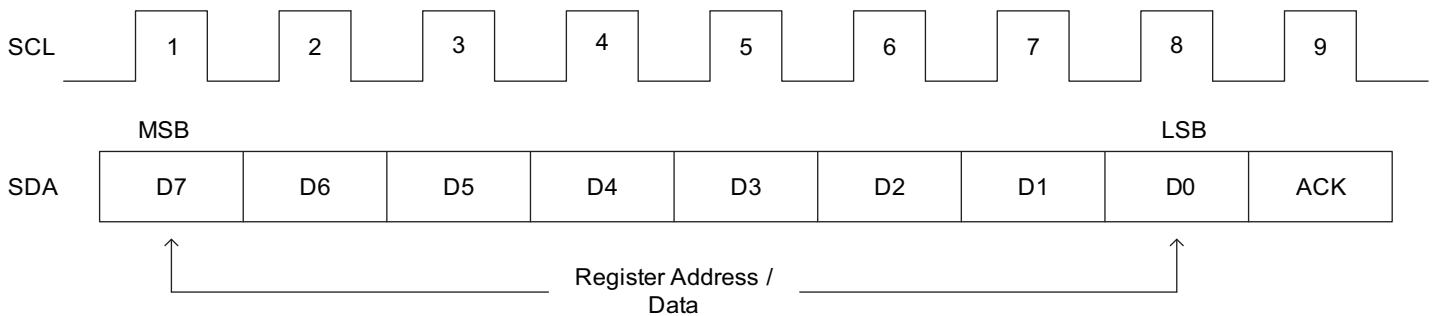

Figure 3: I²C STOP and START Conditions.

START: A High "1" to Low "0" Transition on the SDA Line While SCL is High "1"
STOP: A Low "0" to High "1" Transition on the SDA Line While SCL is High "1"



**Figure 4: I²C Address Bit Map;
 7-bit Slave Address (A6-A0), 1-bit Read/Write (R/W), 1-bit Acknowledge (ACK).**



**Figure 5: I²C Register Address and Data Bit Map;
 8-bit Data (D7-D0), 1-bit Acknowledge (ACK).**

1.5A Step-Up Current Regulator for Flash LEDs

Device Register Information

To program the register through the I²C interface, the master needs to send the AAT1272's device address, 0x37 (Hex), first, and then sends an 8-bit register address and 8-bit data. The AAT1272 has two registers, Register 0 and Register 1. If no instruction is written to the register, the default value is applied.

Register 0 (REG0), Register Address: 00h

Bits [7:4] Program the movie-mode current with 16 different percentage levels.

Bits [3:0] Program the flash safety timeout with 16 different fractions from the hardware configuration, CT.

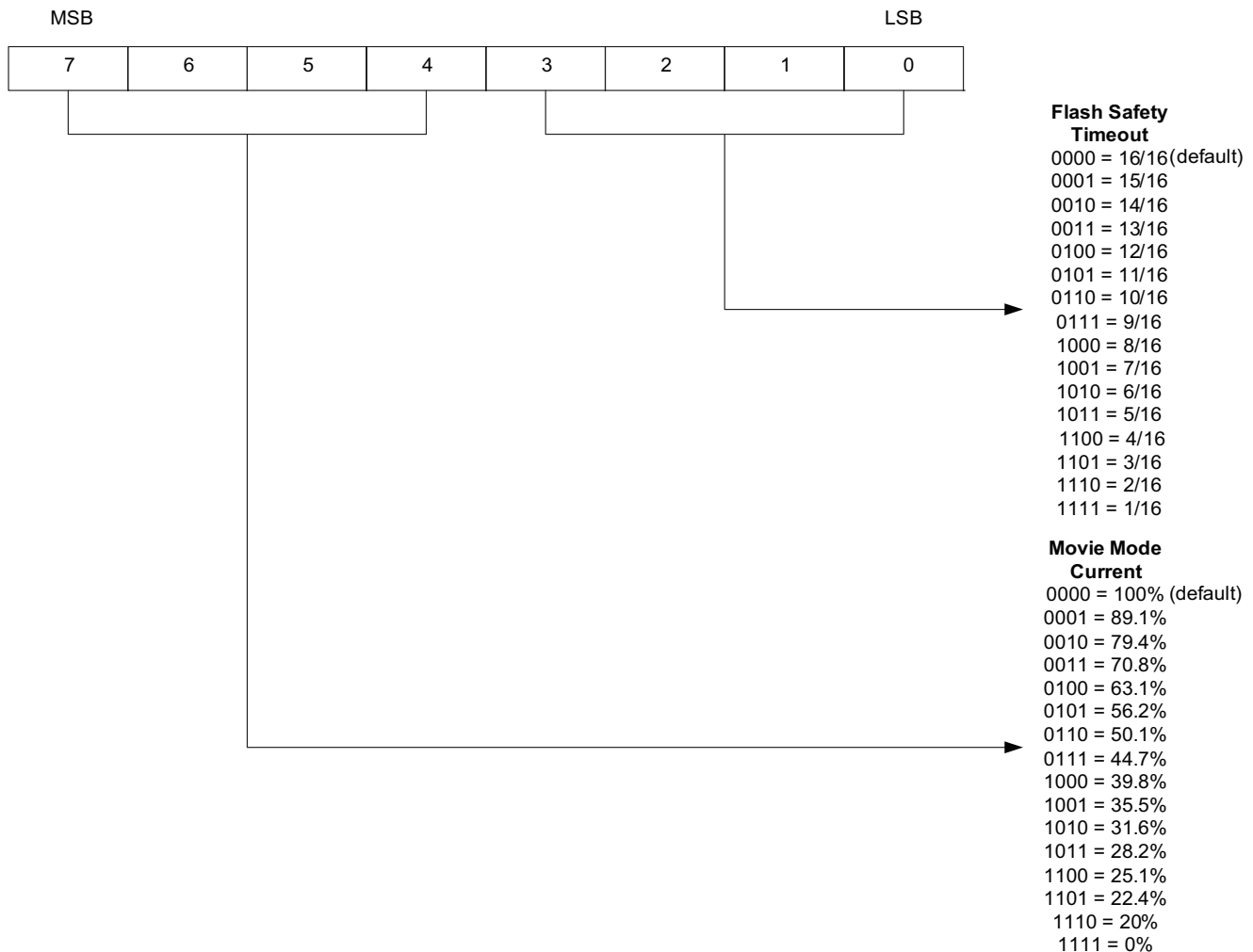

Figure 6: AAT1272 Register 0 Programming.

1.5A Step-Up Current Regulator for Flash LEDs

Register 1 (REG1); Register Address: 01h

Bits [5:4] Program the FLOUTA and FLOUTB with four ON/OFF configurations.

Bits [3:0] Program the flash-to-movie mode ratio with 16 different fractions from the hardware configuration, RSET.

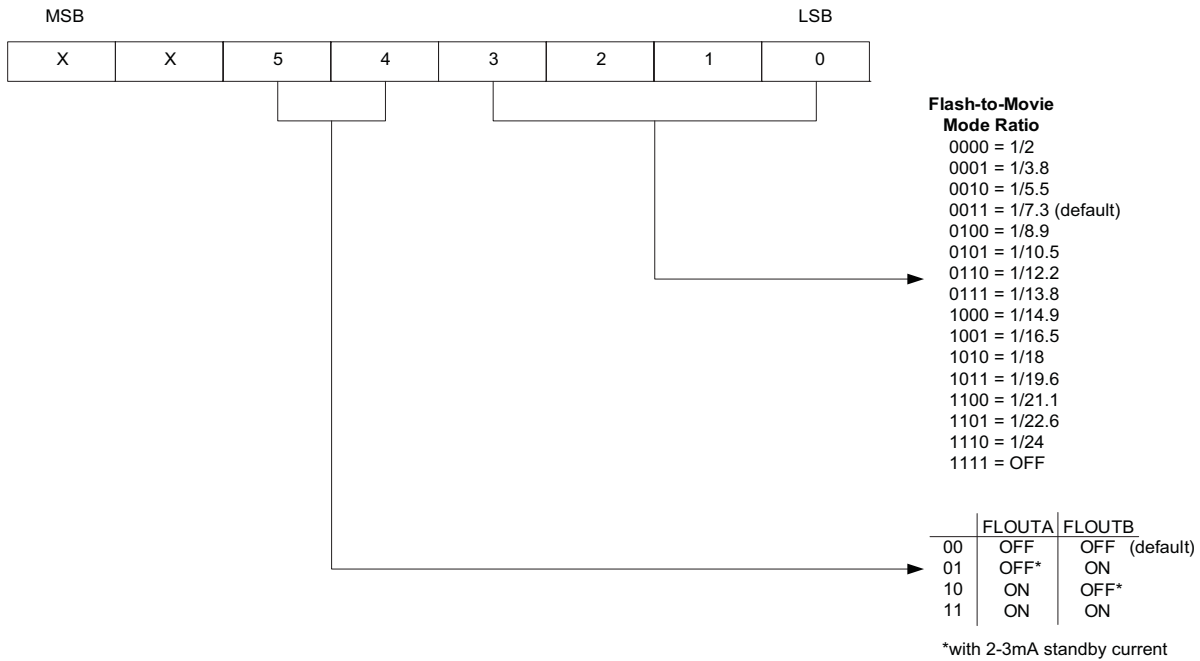

Figure 7: AAT1272 Register 1 Programming.

Selecting the Boost Inductor

The AAT1272 controller utilizes PWM control and the switching frequency is fixed. To maintain 2MHz maximum switching frequency and stable operation, a 1µH inductor is recommended. Manufacturer’s specifications list both the inductor DC current rating, which is a thermal limitation, and peak inductor current rating, which is determined by the saturation characteristics. Measurements at full load and high ambient temperature should be performed to ensure that the inductor does not saturate or exhibit excessive temperature rise.

The inductor (L) is selected to avoid saturation at minimum input voltage and maximum output load conditions. Worst-case peak current occurs at minimum input voltage (maximum duty cycle) and maximum load. Bench measurements are recommended to confirm actual I_{PEAK} and to ensure that the inductor does not saturate at maximum LED current and minimum input supply voltage. The RMS current flowing through the boost inductor

is equal to the DC plus AC ripple components. Under worst case RMS conditions, the current waveform is critically continuous. The resulting RMS calculation yields worst case inductor loss. The RMS current value should be compared against the inductor manufacturer’s temperature rise, or thermal derating guidelines:

$$I_{RMS} = \frac{I_{PEAK}}{\sqrt{3}}$$

For a given inductor type, smaller inductor size leads to an increase in DCR winding resistance and, in most cases, increased thermal impedance. Winding resistance degrades boost converter efficiency and increases the inductor’s operating temperature:

$$P_{LOSS(INDUCTOR)} = I_{RMS}^2 \cdot DCR$$

*Denotes the default value.

1.5A Step-Up Current Regulator for Flash LEDs

Selecting the Boost Capacitors

In general, it is good design practice to place a decoupling capacitor (input capacitor) between the IN and GND pins. An input capacitor in the range of 2.2 μ F to 10 μ F is recommended. A larger input capacitor in this application may be required for stability, transient response, and/or ripple performance. The high output ripple inherent in the boost converter necessitates the use of low impedance output filtering. Multi-layer ceramic (MLC) capacitors provide small size and adequate capacitance, low parasitic equivalent series resistance (ESR) and equivalent series inductance (ESL), and are well suited for use with the AAT1272 boost regulator. MLC capacitors of type X7R or X5R are recommended to ensure good capacitance stability over the full operating temperature range. The output capacitor is selected to maintain the output load without significant voltage droop (ΔV_{OUT}) during the power switch ON interval. A 2.2 μ F ceramic output capacitor is recommended (see Table 7). Typically, 6.3V or 10V rated capacitors are required for this flash LED boost output. Ceramic capacitors selected as small as 0603 are available which meet these requirements. MLC capacitors exhibit significant capacitance reduction with applied voltage. Output ripple measurements should confirm that output voltage droop and operating stability are within acceptable limits. Voltage derating can minimize this factor, but results may vary with package size and among specific manufacturers. To maintain stable operation at full load, the output capacitor should be selected to maintain ΔV_{OUT} between 100mV and 200mV. The boost converter input current flows during both ON and OFF switching intervals. The input ripple current is less than

the output ripple and, as a result, less input capacitance is required.

PCB Layout Guidelines

Boost converter performance can be adversely affected by poor layout. Possible impact includes high input and output voltage ripple, poor EMI performance, and reduced operating efficiency. Every attempt should be made to optimize the layout in order to minimize parasitic PCB effects (stray resistance, capacitance, and inductance) and EMI coupling from the high frequency SW node. A suggested PCB layout for the AAT1272 1.5A step-up regulator is shown in Figures 4 and 5. The following PCB layout guidelines should be considered:

1. Minimize the distance from capacitor C_{IN} and C_{OUT} 's negative terminals to the PGND pins. This is especially true with output capacitor C_{OUT} , which conducts high ripple current from the output to the PGND pins.
2. Minimize the distance under the inductor between IN and switching pin SW; minimize the size of the PCB area connected to the SW pin.
3. Maintain a ground plane and connect to the IC PGND pin(s) as well as the PGND connections of C_{IN} and C_{OUT} .
4. Consider additional PCB exposed area for the flash LEDs to maximize heatsinking capability. This may be necessary when using high current application and long flash duration application.
5. Connect the exposed paddle (bottom of the die) to either PGND or GND. Connect AGND, FLGND to GND as close as possible to the package.

Manufacturer	Part Number	Inductance (μ H)	Saturated Rated Current (A)	DCR (m Ω)	Size (mm) LxWxH	Type
Cooper Bussmann	SD3812-1R0-R	1	2.69	48	4.0x4.0x1.2	Shielded Drum Core
Cooper Bussmann	SDH3812-1R0-R	1	3	45	3.8x3.8x1.2	Shielded Drum Core
Cooper Bussmann	SD10-1R0-R	1	2.25	44.8	5.2x5.2x1.0	Shielded Drum Core
Sumida	CDH38D11/S	1	2.8	48.8	4.0x4.0x1.2	Shielded Drum Core
Coilcraft	LPS4012-102NLC	1	2.5	60	4.1x4.1x1.2	Shielded Drum Core

Table 6: Typical Suggested Surface Mount Inductors.

Manufacturer	Part Number	Capacitance (μ F)	Voltage Rating (V)	Temp Co.	Case Size
Murata	GRM185R60J225KE26	2.2	6.3	X5R	0603
	GRM188R71A225KE15	2.2	10	X7R	0603
	GRM21BR70J225KA01	2.2	6.3	X7R	0805
	GRM21BR71A225KA01	2.2	10	X7R	0805
	GRM219R61A475KE19	4.7	10	X5R	0805
	GRM21BR71A106KE51	10	10	X7R	0805

Table 7: Typical Suggested Surface Mount Capacitors.

AAT1272

1.5A Step-Up Current Regulator for Flash LEDs

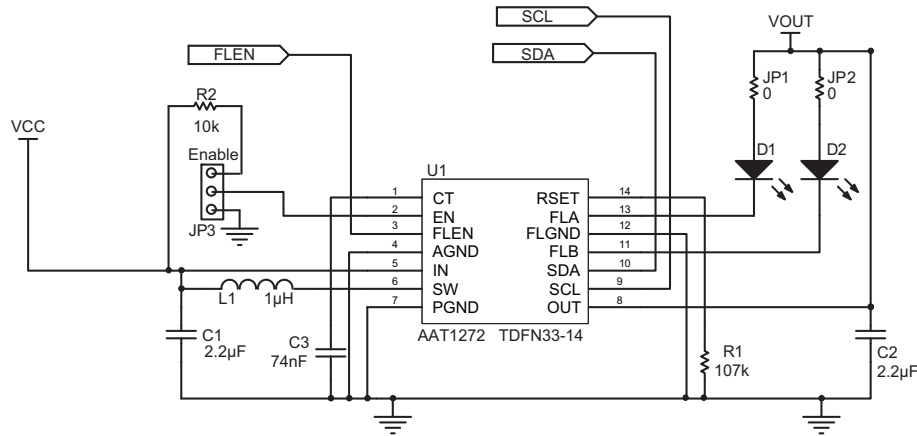

- L1 Cooper Bussmann SD3812-1R0-R, 1µH, 2.69A, 48mΩ
- C1, C2 Murata GRM188R71A225KE15, 2.2µF, 0603, X7R, 10V
- C3 Murata GRM155R71A743KA01, 74nF, 0402, X7R, 10V
- D1, D2 Lumiled LXCL-PWF4 or equivalent

Figure 8: AAT1272 Evaluation Board Schematic.

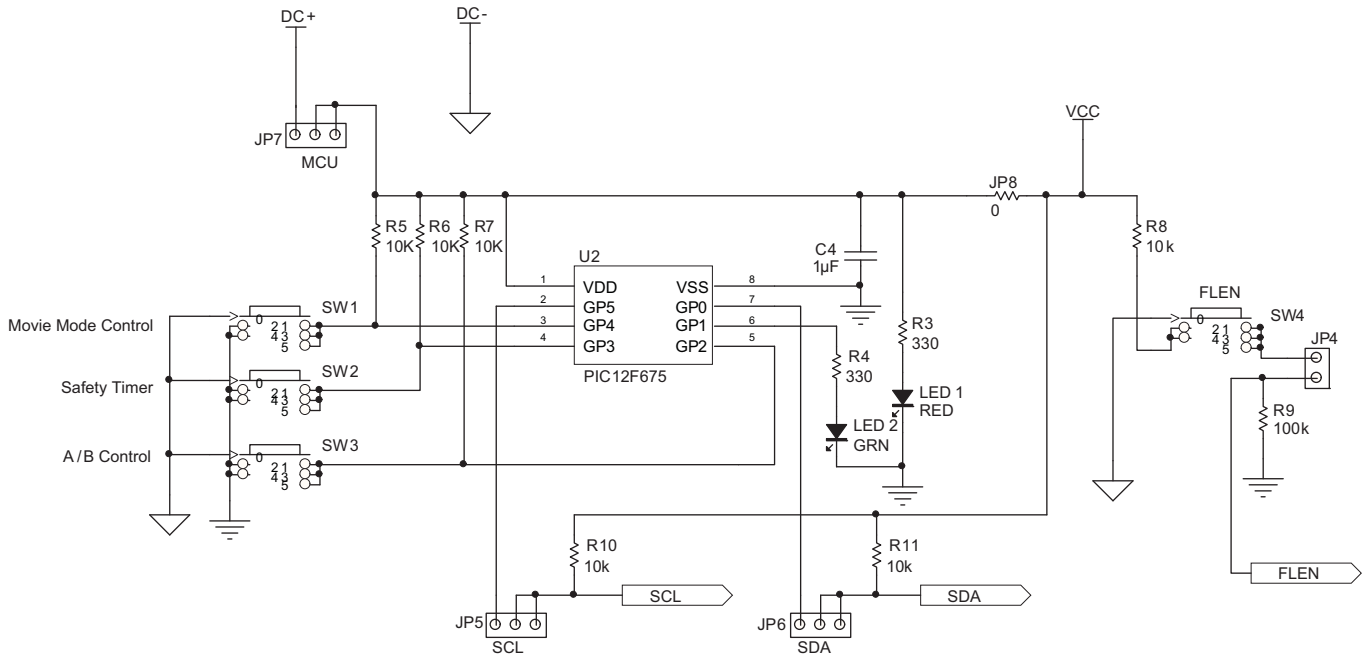

Figure 9: AAT1272 Evaluation Board MCU Section Schematic.

AAT1272

1.5A Step-Up Current Regulator for Flash LEDs

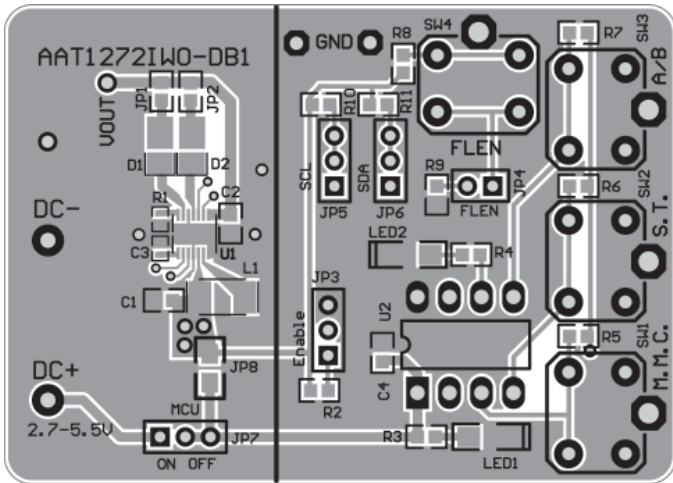

Figure 10: AAT1272 Evaluation Board Top Side Layout.

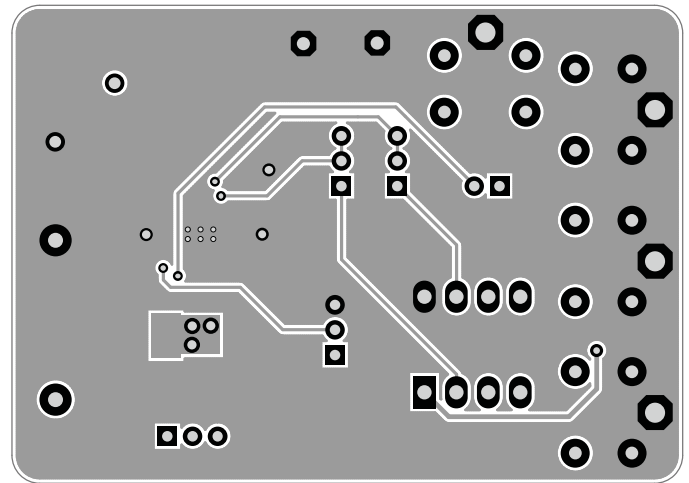

Figure 11: AAT1272 Evaluation Board Bottom Side Layout.

Component	Part Number	Description	Manufacturer
U1	AAT1272IWO	1.5A Step-Up Current Regulator for Flash LEDs; TDFN33-14 package	Skyworks
U2	PIC12F675	8-bit CMOS, FLASH-based µC; 8-pin PDIP package	Microchip
SW1 - SW3	PTS645TL50	Switch, SPST, 5mm	ITT Industries
R1	Chip Resistor	107kΩ, 1%, 1/4W; 0402	Vishay
R2, R9	Chip Resistor	100kΩ, 1%, 1/4W; 0603	Vishay
R5 - R8, R10, R11	Chip Resistor	10kΩ, 5%, 1/4W; 0603	Vishay
R3, R4	Chip Resistor	330Ω, 5%, 1/4W; 0603	Vishay
JP1, JP2, JP8	Chip Resistor	0Ω, 5%	Vishay
C1, C2	GRM188R71A225KE15	2.2µF, 10V, X7R, 0603	Murata
C3	GRM155R71A743KA01	74nF, 10V, X7R, 0402	Murata
C4	GRM216R61A105KA01	1µF, 10V, X5R, 0805	Murata
L1	SD3812-1R0-R	Drum Core, 1µH, 2.69A, 48mΩ	Cooper Bussmann
D1-D2	LXCL-PWF4	White Flash LED	Lumileds, Philips
LED1	CMD15-21SRC/TR8	Red LED; 1206	Chicago Miniature Lamp
LED2	CMD15-21VGC/TR8	Green LED; 1206	Chicago Miniature Lamp
JP3, JP4, JP5, JP6, JP7	PRPN401PAEN	Conn. Header, 2mm zip	Sullins Electronics

Table 8: AAT1272 Evaluation Board Bill of Materials.

AAT1272

1.5A Step-Up Current Regulator for Flash LEDs

Ordering Information

Package	Marking ¹	Part Number (Tape and Reel) ²
TDFN33-14	ZNXY	AAT1272IWO-T1



Skyworks Green™ products are compliant with all applicable legislation and are halogen-free.



For additional information, refer to *Skyworks Definition of Green™*, document number SQ04-0074.

Package Information

TDFN33-14³

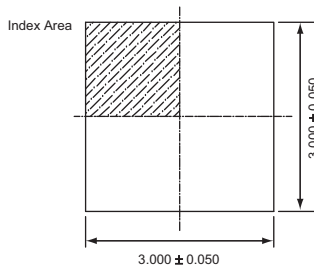

Top View

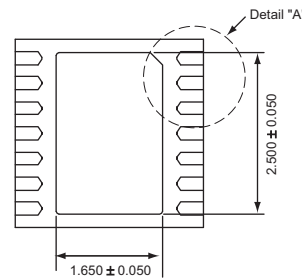

Bottom View

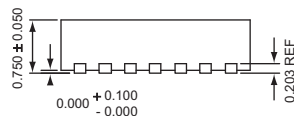

Side View

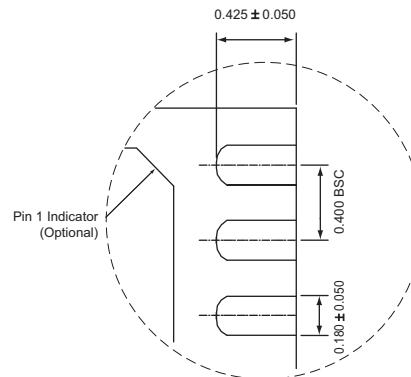

Detail "A"

All dimensions in millimeters.

1. XYY = assembly and date code.
2. Sample stock is generally held on part numbers listed in **BOLD**.
3. The leadless package family, which includes QFN, TQFN, DFN, TDFN, and STDFN, has exposed copper (unplated) at the end of the lead terminals due to the manufacturing process. A solder fillet at the exposed copper edge cannot be guaranteed and is not required to ensure a proper bottom solder connection.

1.5A Step-Up Current Regulator for Flash LEDs

Copyright © 2012 Skyworks Solutions, Inc. All Rights Reserved.

Information in this document is provided in connection with Skyworks Solutions, Inc. ("Skyworks") products or services. These materials, including the information contained herein, are provided by Skyworks as a service to its customers and may be used for informational purposes only by the customer. Skyworks assumes no responsibility for errors or omissions in these materials or the information contained herein. Skyworks may change its documentation, products, services, specifications or product descriptions at any time, without notice. Skyworks makes no commitment to update the materials or information and shall have no responsibility whatsoever for conflicts, incompatibilities, or other difficulties arising from any future changes.

No license, whether express, implied, by estoppel or otherwise, is granted to any intellectual property rights by this document. Skyworks assumes no liability for any materials, products or information provided hereunder, including the sale, distribution, reproduction or use of Skyworks products, information or materials, except as may be provided in Skyworks Terms and Conditions of Sale.

THE MATERIALS, PRODUCTS AND INFORMATION ARE PROVIDED "AS IS" WITHOUT WARRANTY OF ANY KIND, WHETHER EXPRESS, IMPLIED, STATUTORY, OR OTHERWISE, INCLUDING FITNESS FOR A PARTICULAR PURPOSE OR USE, MERCHANTABILITY, PERFORMANCE, QUALITY OR NON-INFRINGEMENT OF ANY INTELLECTUAL PROPERTY RIGHT; ALL SUCH WARRANTIES ARE HEREBY EXPRESSLY DISCLAIMED. SKYWORKS DOES NOT WARRANT THE ACCURACY OR COMPLETENESS OF THE INFORMATION, TEXT, GRAPHICS OR OTHER ITEMS CONTAINED WITHIN THESE MATERIALS. SKYWORKS SHALL NOT BE LIABLE FOR ANY DAMAGES, INCLUDING BUT NOT LIMITED TO ANY SPECIAL, INDIRECT, INCIDENTAL, STATUTORY, OR CONSEQUENTIAL DAMAGES, INCLUDING WITHOUT LIMITATION, LOST REVENUES OR LOST PROFITS THAT MAY RESULT FROM THE USE OF THE MATERIALS OR INFORMATION, WHETHER OR NOT THE RECIPIENT OF MATERIALS HAS BEEN ADVISED OF THE POSSIBILITY OF SUCH DAMAGE.



Skyworks products are not intended for use in medical, lifesaving or life-sustaining applications, or other equipment in which the failure of the Skyworks products could lead to personal injury, death, physical or environmental damage. Skyworks customers using or selling Skyworks products for use in such applications do so at their own risk and agree to fully indemnify Skyworks for any damages resulting from such improper use or sale.

Customers are responsible for their products and applications using Skyworks products, which may deviate from published specifications as a result of design defects, errors, or operation of products outside of published parameters or design specifications. Customers should include design and operating safeguards to minimize these and other risks. Skyworks assumes no liability for applications assistance, customer product design, or damage to any equipment resulting from the use of Skyworks products outside of stated published specifications or parameters.

Skyworks, the Skyworks symbol, and "Breakthrough Simplicity" are trademarks or registered trademarks of Skyworks Solutions, Inc., in the United States and other countries. Third-party brands and names are for identification purposes only, and are the property of their respective owners. Additional information, including relevant terms and conditions, posted at www.skyworksinc.com, are incorporated by reference.

Looking for pricing, stock, or lifecycle information?

Click below to explore more details on WIN SOURCE:

-  [View AAT1272IWO-T1 on WIN SOURCE](#)
-  [Skyworks Solutions Inc. Information](#)

Optimize Your Supply Chain with WIN SOURCE Solutions

-  Global Sourcing Solution
-  Obsolete Management
-  Cost Control Management
-  Shortage Management
-  Alternative Solution
-  Excess Inventory Management