

DATA SHEET

AA116-72LF: 4 MHz to 2 GHz 1-Bit Digital Attenuator (15 dB LSB)

Applications

- Cellular radio
- Wireless data systems
- WLL gain level control circuits

Features

- 3 V control
- Low loss
- Small SOT-5 package (MSL1, 260 °C per JEDEC J-STD-020)

 Skyworks Green™ products are compliant with all applicable legislation and are halogen-free. For additional information, refer to *Skyworks Definition of Green™*, document number SQ04-0074.

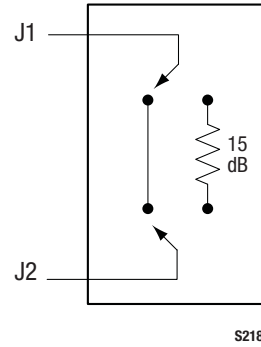

Figure 1. AA116-72LF Block Diagram

Description

The AA116-72LF is a 1-bit GaAs FET digital attenuator in a low-cost SOT-5 package. The device has a Least Significant Bit (LSB) of 15 dB and is particularly suited where high attenuation accuracy, low insertion loss, and low intermodulation products are required.

A functional block diagram is shown in Figure 1. The pin configuration and package are shown in Figure 2. Signal pin assignments and functional pin descriptions are provided in Table 1.

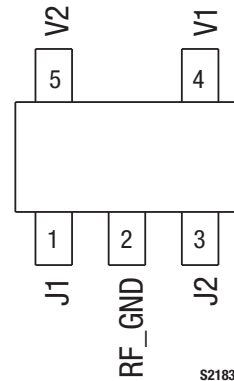

Figure 2. AA116-72LF Pinout – 5-Pin SOT-5 (Top View)

Table 1. AA116-72LF Signal Descriptions

Pin	Name	Description	Pin	Name	Description
1	J1	RF port. Must be DC blocked.	4	V1	DC control bias
2	RF_GND	RF ground. Must be AC-coupled to ground.	5	V2	DC control bias
3	J2	RF port. Must be DC blocked.			

Table 2. AA116-72LF Absolute Maximum Ratings (Note 1)

Parameter	Symbol	Minimum	Maximum	Units
RF input power	P _{IN}		1 W > 500 MHz 0/8 V 0.5 W @ 50 MHz 0/8 V	dBm dBm
Supply voltage	V _S		8	V
Control voltage	V _{CTL}	-0.2	+8.0	V
Operating temperature	T _{OP}	-40	+85	°C
Storage temperature	T _{STG}	-65	+150	°C

Note 1: Exposure to maximum rating conditions for extended periods may reduce device reliability. There is no damage to device with only one parameter set at the limit and all other parameters set at or below their nominal value. Exceeding any of the limits listed here may result in permanent damage to the device.

CAUTION: Although this device is designed to be as robust as possible, electrostatic discharge (ESD) can damage this device. This device must be protected at all times from ESD. Static charges may easily produce potentials of several kilovolts on the human body or equipment, which can discharge without detection. Industry-standard ESD precautions should be used at all times.

Electrical and Mechanical Specifications

The absolute maximum ratings of the AA116-72LF are provided in Table 2. Electrical specifications are provided in Table 3.

Typical performance characteristics of the AA116-72LF are illustrated in Figures 3 through 6.

The state of the AA116-72LF is determined by the logic provided in Table 4.

Table 3. AA116-72LF Electrical Specifications (Note 1)
($V_{CTL} = 0$ to 3 V, $T_{OP} = +25$ °C, Characteristic Impedance [Z_0] = 50 Ω , Unless Otherwise Noted)

Parameter	Symbol	Test Condition	Min	Typical	Max	Units
Insertion loss (Note 2)	IL	0.004 to 0.05 GHz		0.35	0.45	dB
		0.5 to 1.00 GHz		0.35	0.45	dB
		0.85 to 0.94 GHz		0.30	0.38	dB
		1.00 to 2.00 GHz		0.40	0.50	dB
Attenuation range			15		dB	
Attenuation accuracy (Note 3)		0.004 to 0.05 GHz	14.0	14.6	16.0	dB
		0.50 to 2.00 GHz	14.0	15.0	16.0	dB
		0.85 to 0.94 GHz	14.5	15.0	15.5	dB
Return loss		0.004 to 0.05 GHz		30		dB
		0.50 to 1.00 GHz		24		dB
Switching characteristics (Note 4): Rise/fall On/off Video feedthrough		10/90% or 90/10% RF 50% V_{CTL} to 90/10% RF $T_{RISE} = 1$ ns, bandwidth = 500 MHz		40		ns
				50		ns
				70		mV
1 dB Input Compression Point	IP1dB	4 to 50 MHz, $V_s = 5$ V	+9	+12		dBm
		0.5 to 2.5 GHz, $V_s = 3$ V		+20		dBm
		0.5 to 2.5 GHz, $V_s = 5$ V		+26		dBm
3 rd Order Input Intercept Point	IIP3	For two-tone input power, +10 dBm/tone, 0.5 to 2.5 GHz $V_s = 3$ V $V_s = 5$ V		+41		dBm
				+45		dBm
Control voltage:						
Low	V_{CTL_LOW}		0		0.2	V
High	V_{CTL_HIGH}		2	3	5	V

Note 1: Performance is guaranteed only under the conditions listed in this table.

Note 2: Insertion loss changes by 0.003 dB/°C.

Note 3: Maximum attenuation includes insertion loss.

Note 4: Switching characteristics will vary with the value chosen for the blocking capacitors.

Typical Performance Characteristics

($V_{CTL} = 0$ to 3 V, $T_{OP} = +25$ °C, Characteristic Impedance [Z_0] = 50 Ω , Unless Otherwise Noted)

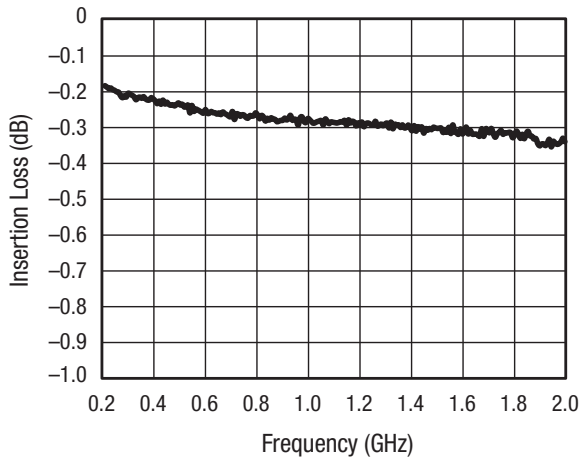

Figure 3. Insertion Loss vs Frequency

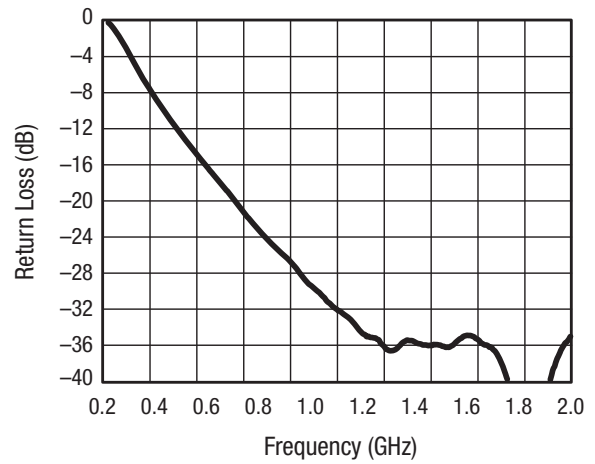

Figure 4. Return Loss in Insertion Loss State vs Frequency

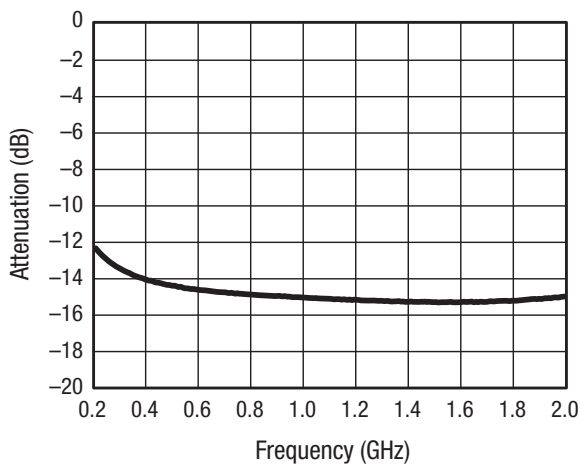

Figure 5. Attenuation vs Frequency

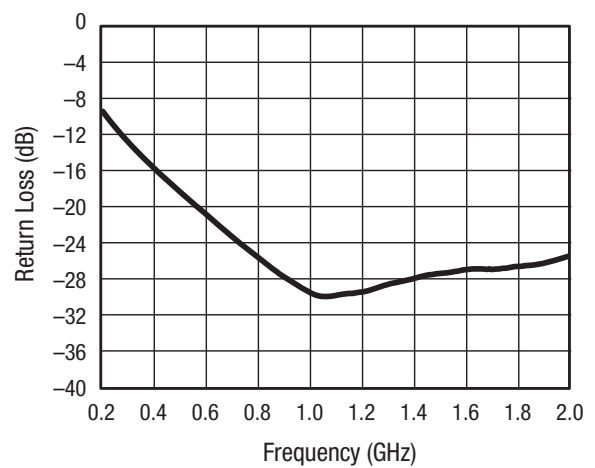

Figure 6. Return Loss in Attenuation State vs Frequency

Table 4. AA116-72LF Truth Table (Note 1)

J1 to J2	V1 (Pin 4)	V2 (Pin 5)
Insertion loss	High	Low
Attenuation	Low	High

Note 1: High = Refer to “Control voltage” in Table 3.
 Low = Refer to “Control voltage” in Table 3.
 Any state not described in this table places the attenuator in an undefined state.

Evaluation Board Description

The AA116-72LF Evaluation Board is used to test the performance of the AA116-72LF digital attenuator. An assembly drawing for the Evaluation Board is shown in Figure 7 and an Evaluation Board schematic diagram is shown in Figure 8.

Package Dimensions

Typical part markings are noted in Figure 9. Package dimensions for the 5-pin SOT-5 are shown in Figure 10, and tape and reel dimensions are provided in Figure 11.

Package and Handling Information

Instructions on the shipping container label regarding exposure to moisture after the container seal is broken must be followed. Otherwise, problems related to moisture absorption may occur when the part is subjected to high temperature during solder assembly.

The AA116-72LF is rated to Moisture Sensitivity Level 1 (MSL1) at 260 °C. It can be used for lead or lead-free soldering. For additional information, refer to the Skyworks Application Note, *Solder Reflow Information*, document number 200164.

Care must be taken when attaching this product, whether it is done manually or in a production solder reflow environment. Production quantities of this product are shipped in a standard tape and reel format.

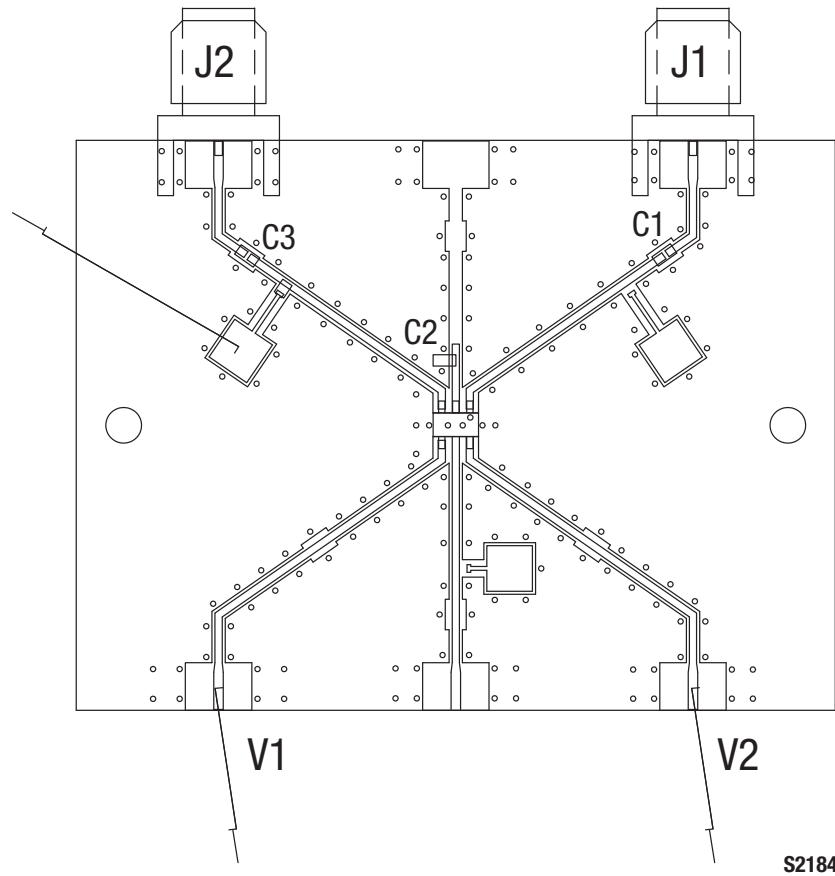

S2184

Figure 7. AA116-72LF Evaluation Board Assembly Diagram

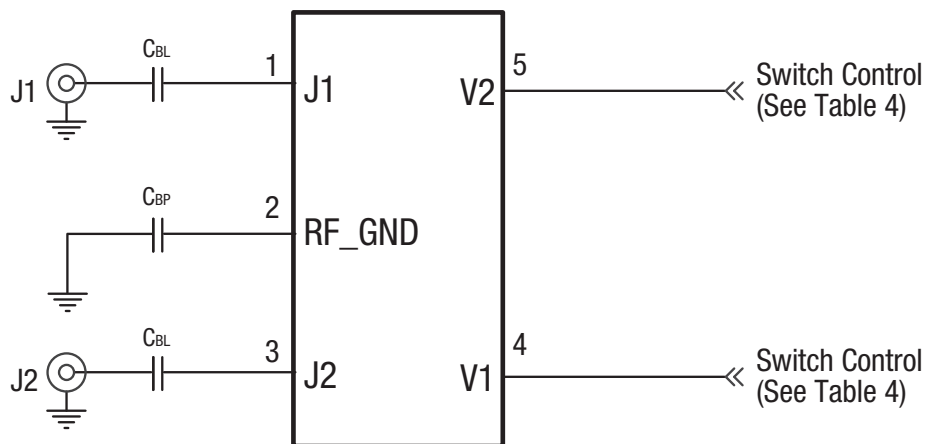

Note: $C_{BL} = 33 \text{ pF}$, $C_{BP} = 39 \text{ pF}$ for 900 MHz operation.
 $C_{BL} = 100 \text{ nF}$, $C_{BP} = 100 \text{ nF}$ for 0.004 to 0.05 GHz operation.

S2185

Figure 8. AA116-72LF Evaluation Board Schematic Diagram

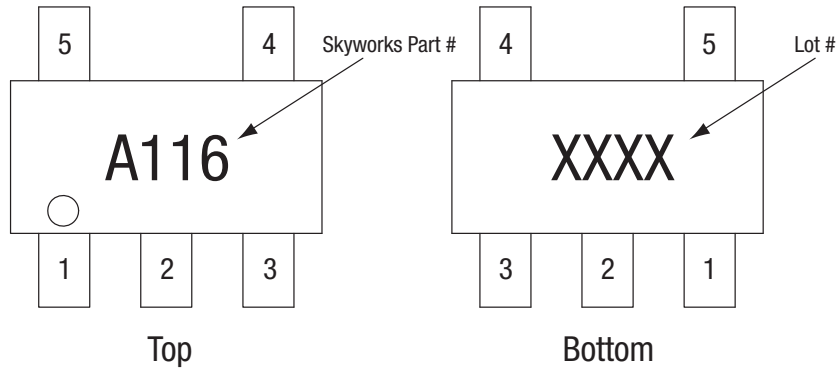
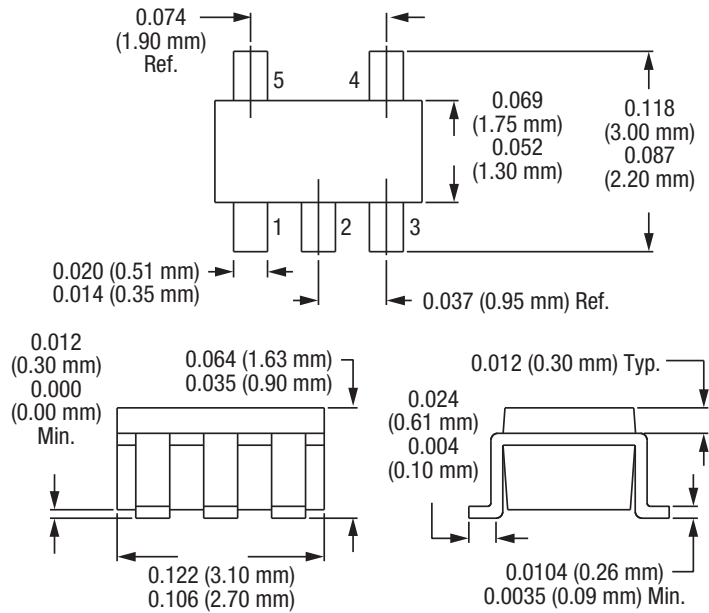

Figure 9. Typical Part Markings



Dimensions are in inches (millimeters shown in parentheses)

S1657

Figure 10. AA116-72LF 5-Pin SOT-5 Package Dimensions

DATA SHEET • AA116-72LF: 1-BIT DIGITAL ATTENUATOR

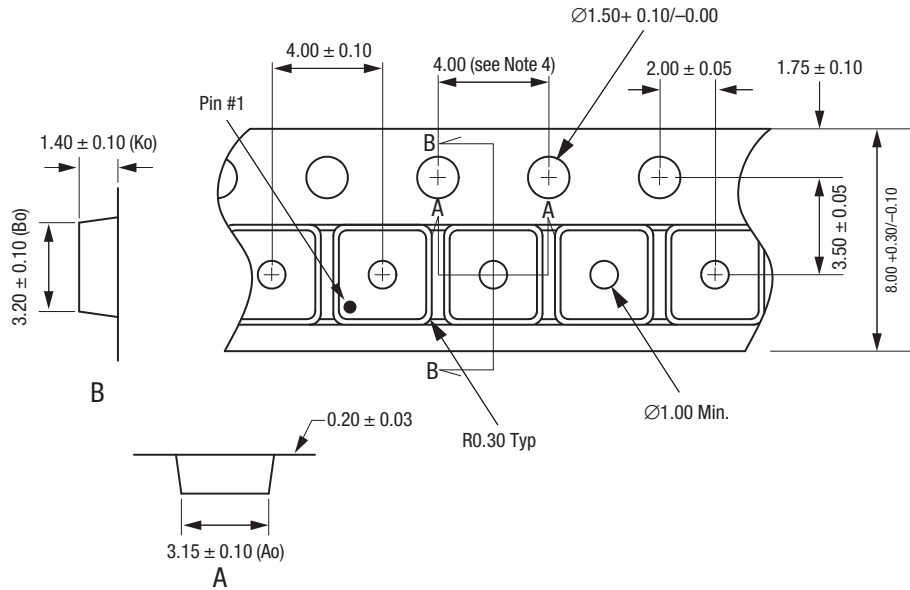

- Notes:
1. Carrier tape: black conductive polystyrene.
 2. Cover tape material: transparent conductive HSA.
 3. Cover tape size: 5.40 mm width.
 4. Ten sprocket hole pitch cumulative tolerance = ±0.20 mm.
 5. All measurements are in millimeters.
 6. Standard reel size is 7 inches. Standard reel quantity is 3000 pcs.

S1681

Figure 11. AA116-72LF Tape and Reel Dimensions

Ordering Information

Model Name	Manufacturing Part Number	Evaluation Board Part Numbers
AA116-72LF: 1-Bit Digital Attenuator	AA116-72LF	AA116-72LF-EVB

Copyright © 2002-2008, 2010, 2014 Skyworks Solutions, Inc. All Rights Reserved.

Information in this document is provided in connection with Skyworks Solutions, Inc. ("Skyworks") products or services. These materials, including the information contained herein, are provided by Skyworks as a service to its customers and may be used for informational purposes only by the customer. Skyworks assumes no responsibility for errors or omissions in these materials or the information contained herein. Skyworks may change its documentation, products, services, specifications or product descriptions at any time, without notice. Skyworks makes no commitment to update the materials or information and shall have no responsibility whatsoever for conflicts, incompatibilities, or other difficulties arising from any future changes.

No license, whether express, implied, by estoppel or otherwise, is granted to any intellectual property rights by this document. Skyworks assumes no liability for any materials, products or information provided hereunder, including the sale, distribution, reproduction or use of Skyworks products, information or materials, except as may be provided in Skyworks Terms and Conditions of Sale.

THE MATERIALS, PRODUCTS AND INFORMATION ARE PROVIDED "AS IS" WITHOUT WARRANTY OF ANY KIND, WHETHER EXPRESS, IMPLIED, STATUTORY, OR OTHERWISE, INCLUDING FITNESS FOR A PARTICULAR PURPOSE OR USE, MERCHANTABILITY, PERFORMANCE, QUALITY OR NON-INFRINGEMENT OF ANY INTELLECTUAL PROPERTY RIGHT; ALL SUCH WARRANTIES ARE HEREBY EXPRESSLY DISCLAIMED. SKYWORKS DOES NOT WARRANT THE ACCURACY OR COMPLETENESS OF THE INFORMATION, TEXT, GRAPHICS OR OTHER ITEMS CONTAINED WITHIN THESE MATERIALS. SKYWORKS SHALL NOT BE LIABLE FOR ANY DAMAGES, INCLUDING BUT NOT LIMITED TO ANY SPECIAL, INDIRECT, INCIDENTAL, STATUTORY, OR CONSEQUENTIAL DAMAGES, INCLUDING WITHOUT LIMITATION, LOST REVENUES OR LOST PROFITS THAT MAY RESULT FROM THE USE OF THE MATERIALS OR INFORMATION, WHETHER OR NOT THE RECIPIENT OF MATERIALS HAS BEEN ADVISED OF THE POSSIBILITY OF SUCH DAMAGE.



Skyworks products are not intended for use in medical, lifesaving or life-sustaining applications, or other equipment in which the failure of the Skyworks products could lead to personal injury, death, physical or environmental damage. Skyworks customers using or selling Skyworks products for use in such applications do so at their own risk and agree to fully indemnify Skyworks for any damages resulting from such improper use or sale.

Customers are responsible for their products and applications using Skyworks products, which may deviate from published specifications as a result of design defects, errors, or operation of products outside of published parameters or design specifications. Customers should include design and operating safeguards to minimize these and other risks. Skyworks assumes no liability for applications assistance, customer product design, or damage to any equipment resulting from the use of Skyworks products outside of stated published specifications or parameters.

Skyworks and the Skyworks symbol are trademarks or registered trademarks of Skyworks Solutions, Inc., in the United States and other countries. Third-party brands and names are for identification purposes only, and are the property of their respective owners. Additional information, including relevant terms and conditions, posted at www.skyworksinc.com, are incorporated by reference.

Looking for pricing, stock, or lifecycle information?

Click below to explore more details on WIN SOURCE:

-  [View AA116-72 on WIN SOURCE](#)
-  [Skyworks Solutions Inc. Information](#)

Optimize Your Supply Chain with WIN SOURCE Solutions

-  Global Sourcing Solution
-  Obsolete Management
-  Cost Control Management
-  Shortage Management
-  Alternative Solution
-  Excess Inventory Management