

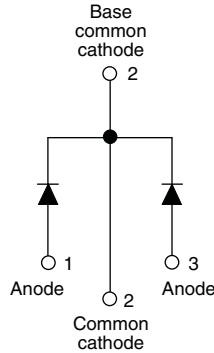



High Performance Schottky Rectifier, 2 x 20 A



FEATURES

- 175 °C Tj operation
Low forward voltage drop
High frequency operation
High purity, high temperature epoxy encapsulation for enhanced mechanical strength and moisture resistance
Guard ring for enhanced ruggedness and long term reliability
Designed and qualified according to JEDEC®-JESD47
Halogen-free according to IEC 61249-2-21 definition (-N3 only)
Material categorization: for definitions of compliance please see www.vishay.com/doc?99912



Table with 2 columns: Parameter and Value. Includes primary characteristics like IF(AV), VR, VF at IF, IRM max., TJ max., EAS, Package, and Circuit configuration.

DESCRIPTION

The VS-40CPQ... center tap Schottky rectifier has been optimized for low reverse leakage at high temperature. The proprietary barrier technology allows for reliable operation up to 175 °C junction temperature.

Table with 4 columns: SYMBOL, CHARACTERISTICS, VALUES, UNITS. Lists major ratings and characteristics such as IF(AV), VRRM, IFSM, VF, and TJ.

Table with 7 columns: PARAMETER, SYMBOL, VS-40CPQ080PbF, VS-40CPQ080-N3, VS-40CPQ100PbF, VS-40CPQ100-N3, UNITS. Shows voltage ratings for different models.

Table with 5 columns: PARAMETER, SYMBOL, TEST CONDITIONS, VALUES, UNITS. Details absolute maximum ratings for current, surge current, avalanche energy, and current.



ELECTRICAL SPECIFICATIONS					
PARAMETER	SYMBOL	TEST CONDITIONS		VALUES	UNITS
Maximum forward voltage drop per leg See fig. 1	$V_{FM}^{(1)}$	20 A	$T_J = 25\text{ }^\circ\text{C}$	0.77	V
		40 A		0.91	
		20 A	$T_J = 125\text{ }^\circ\text{C}$	0.61	
		40 A		0.75	
Maximum reverse leakage current per leg See fig. 2	$I_{RM}^{(1)}$	$T_J = 25\text{ }^\circ\text{C}$	$V_R = \text{Rated } V_R$	1.25	mA
		$T_J = 125\text{ }^\circ\text{C}$		15	
Maximum junction capacitance per leg	$C_T$	$V_R = 5 V_{DC}$ (test signal range 100 kHz to 1 MHz) $25\text{ }^\circ\text{C}$		600	pF
Typical series inductance per leg	$L_S$	Measured lead to lead 5 mm from package body		7.5	nH
Maximum voltage rate of change	dV/dt	Rated $V_R$		10 000	V/ $\mu$ s

**Note**

(1) Pulse width < 300  $\mu$ s, duty cycle < 2 %

THERMAL - MECHANICAL SPECIFICATIONS					
PARAMETER	SYMBOL	TEST CONDITIONS		VALUES	UNITS
Maximum junction and storage temperature range	$T_J, T_{Stg}$			-55 to 175	$^\circ\text{C}$
Maximum thermal resistance, junction to case per leg	$R_{thJC}$	DC operation See fig. 4		1.25	$^\circ\text{C/W}$
Maximum thermal resistance, junction to case per package		DC operation		0.63	
Typical thermal resistance, case to heatsink	$R_{thCS}$	Mounting surface, smooth and greased		0.24	
Approximate weight				6	g
				0.21	oz.
Mounting torque	minimum maximum		Non-lubricated threads	6 (5)	kgf · cm (lbf · in)
				12 (10)	
Marking device			Case style TO-247AC (JEDEC)	40CPQ080	
				40CPQ100	

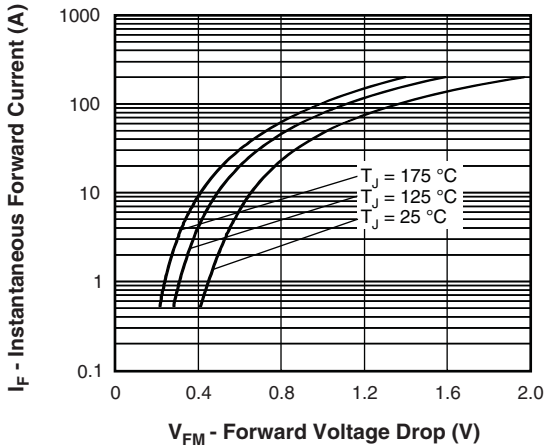

Fig. 1 - Maximum Forward Voltage Drop Characteristics (Per Leg)

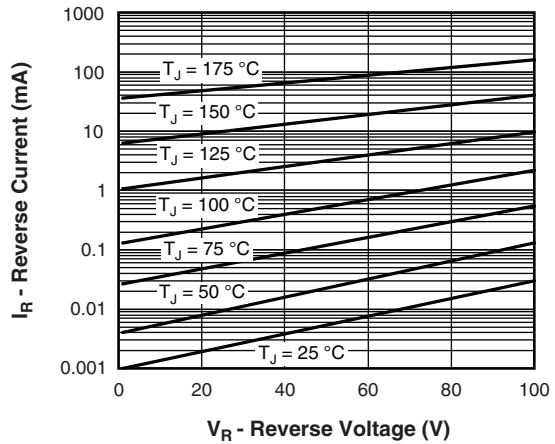

Fig. 2 - Typical Values of Reverse Current vs. Reverse Voltage (Per Leg)

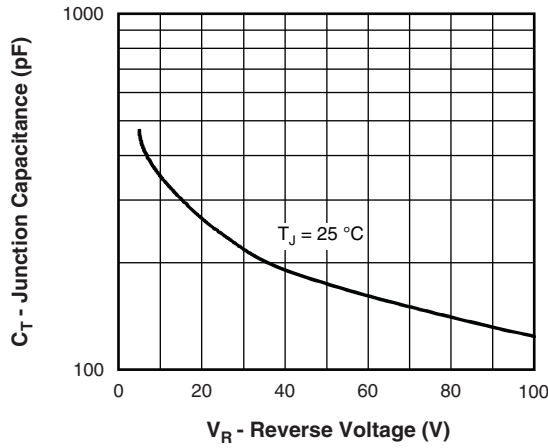

Fig. 3 - Typical Junction Capacitance vs. Reverse Voltage (Per Leg)

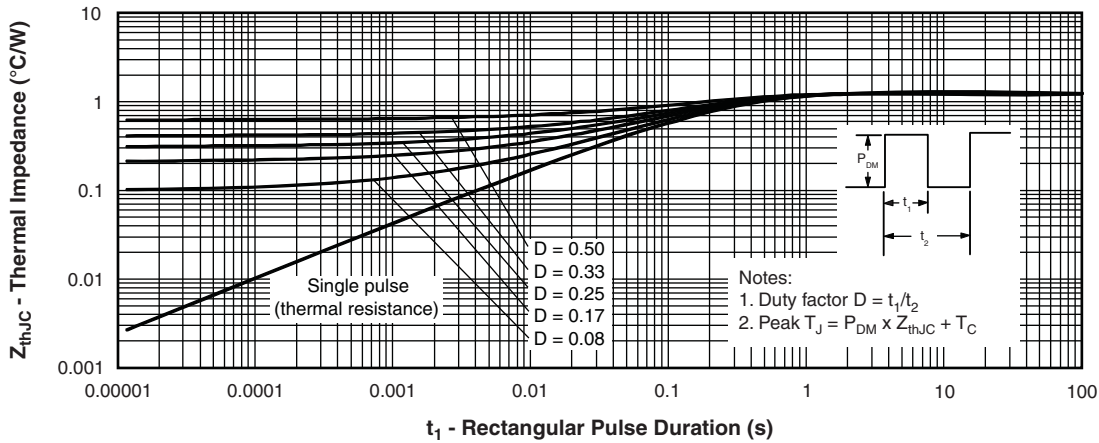

Fig. 4 - Maximum Thermal Impedance  $Z_{thJC}$  Characteristics (Per Leg)

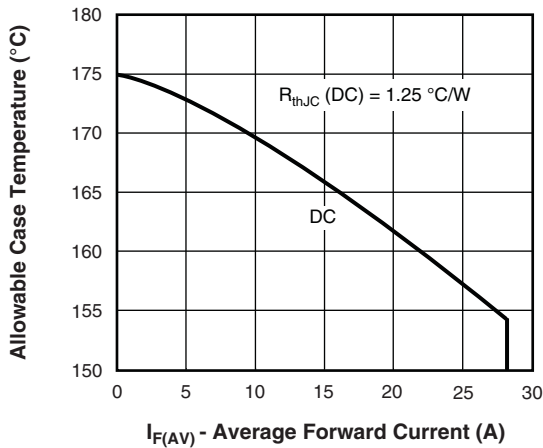

Fig. 5 - Maximum Allowable Case Temperature vs. Average Forward Current (Per Leg)

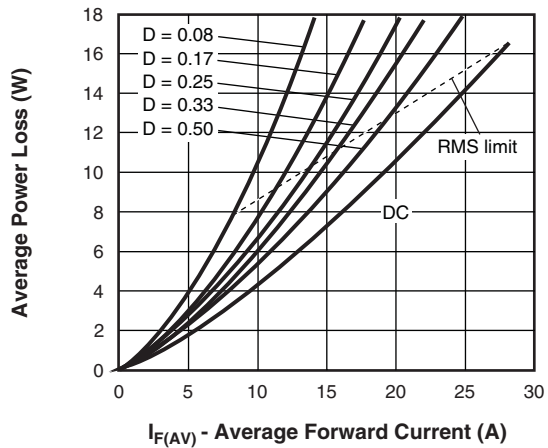

Fig. 6 - Forward Power Loss Characteristics (Per Leg)

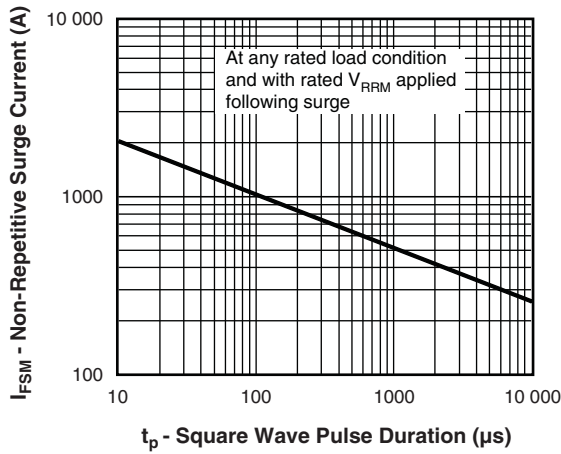

Fig. 7 - Maximum Non-Repetitive Surge Current (Per Leg)

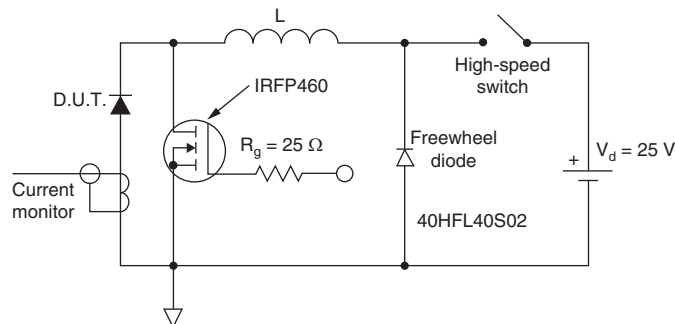
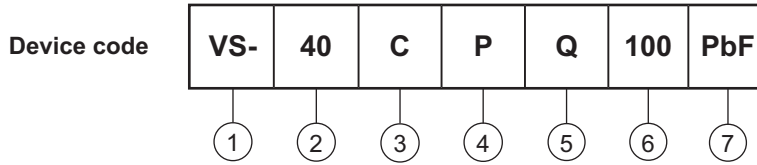

Fig. 8 - Unclamped Inductive Test Circuit



## ORDERING INFORMATION TABLE



- 1** - Vishay Semiconductors product
- 2** - Current rating (40 = 40 A)
- 3** - Circuit configuration:  
C = common cathode
- 4** - Package:  
P = TO-247
- 5** - Schottky "Q" series
- 6** - Voltage code 

080 = 80 V
100 = 100 V
- 7** - Environmental digit
  - PbF = lead (Pb)-free and RoHS-compliant
  - -N3 = halogen-free, RoHS-compliant, and totally lead (Pb)-free

<b>ORDERING INFORMATION</b> (Example)			
PREFERRED P/N	QUANTITY PER T/R	MINIMUM ORDER QUANTITY	PACKAGING DESCRIPTION
VS-40CPQ080PbF	25	500	Antistatic plastic tube
VS-40CPQ080-N3	25	500	Antistatic plastic tube
VS-40CPQ100PbF	25	500	Antistatic plastic tube
VS-40CPQ100-N3	25	500	Antistatic plastic tube

<b>LINKS TO RELATED DOCUMENTS</b>		
Dimensions		<a href="http://www.vishay.com/doc?95542">www.vishay.com/doc?95542</a>
Part marking information	TO-247AC PbF	<a href="http://www.vishay.com/doc?95226">www.vishay.com/doc?95226</a>
	TO-247AC -N3	<a href="http://www.vishay.com/doc?95007">www.vishay.com/doc?95007</a>
SPIICE model		<a href="http://www.vishay.com/doc?96496">www.vishay.com/doc?96496</a>



## TO-247AC

**DIMENSIONS** in millimeters and inches

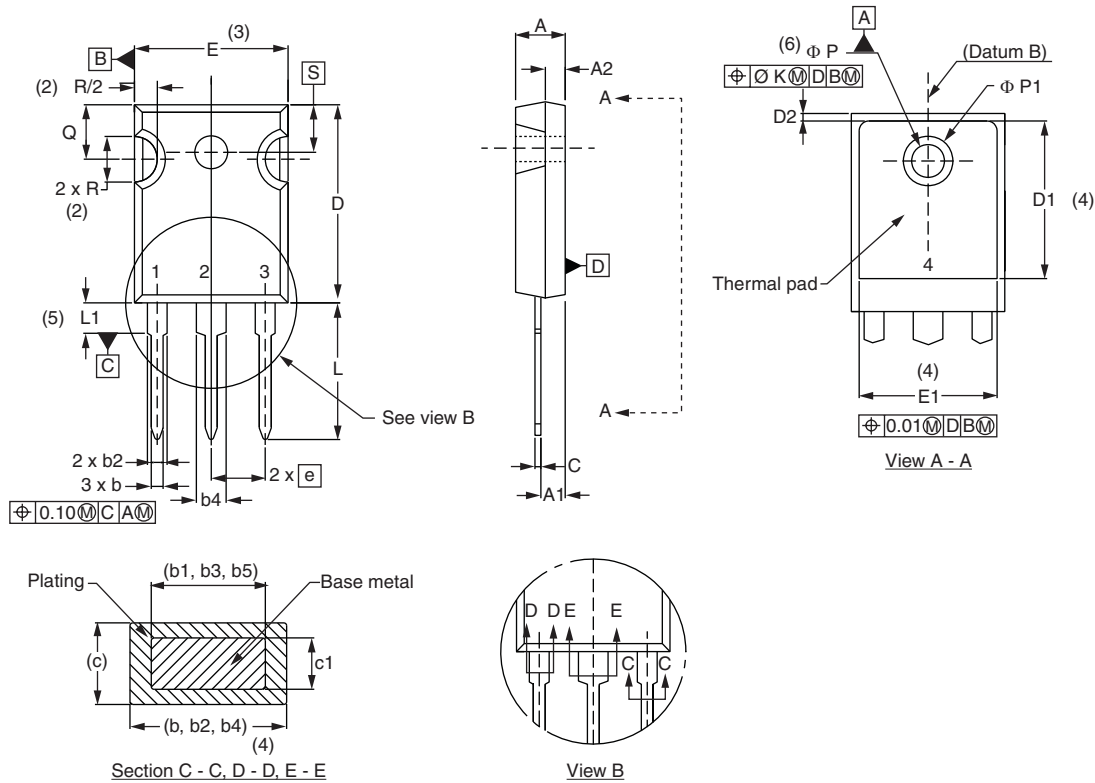

SYMBOL	MILLIMETERS		INCHES		NOTES	SYMBOL	MILLIMETERS		INCHES		NOTES
	MIN.	MAX.	MIN.	MAX.			MIN.	MAX.	MIN.	MAX.	
A	4.65	5.31	0.183	0.209		D2	0.51	1.30	0.020	0.051	
A1	2.21	2.59	0.087	0.102		E	15.29	15.87	0.602	0.625	3
A2	1.50	2.49	0.059	0.098		E1	13.72	-	0.540	-	
b	0.99	1.40	0.039	0.055		e	5.46 BSC		0.215 BSC		
b1	0.99	1.35	0.039	0.053		Ø K	2.54		0.010		
b2	1.65	2.39	0.065	0.094		L	14.20	16.10	0.559	0.634	
b3	1.65	2.34	0.065	0.092		L1	3.71	4.29	0.146	0.169	
b4	2.59	3.43	0.102	0.135		Ø P	3.56	3.66	0.14	0.144	
b5	2.59	3.38	0.102	0.133		Ø P1	-	6.98	-	0.275	
c	0.38	0.89	0.015	0.035		Q	5.31	5.69	0.209	0.224	
c1	0.38	0.84	0.015	0.033		R	4.52	5.49	0.178	0.216	
D	19.71	20.70	0.776	0.815	3	S	5.51 BSC		0.217 BSC		
D1	13.08	-	0.515	-	4						

**Notes**

- (1) Dimensioning and tolerancing per ASME Y14.5M-1994
- (2) Contour of slot optional
- (3) Dimension D and E do not include mold flash. Mold flash shall not exceed 0.127 mm (0.005") per side. These dimensions are measured at the outermost extremes of the plastic body
- (4) Thermal pad contour optional with dimensions D1 and E1
- (5) Lead finish uncontrolled in L1
- (6) Ø P to have a maximum draft angle of 1.5 to the top of the part with a maximum hole diameter of 3.91 mm (0.154")
- (7) Outline conforms to JEDEC® outline TO-247 with exception of dimension c



## **Disclaimer**

ALL PRODUCT, PRODUCT SPECIFICATIONS AND DATA ARE SUBJECT TO CHANGE WITHOUT NOTICE TO IMPROVE RELIABILITY, FUNCTION OR DESIGN OR OTHERWISE.

Vishay Intertechnology, Inc., its affiliates, agents, and employees, and all persons acting on its or their behalf (collectively, "Vishay"), disclaim any and all liability for any errors, inaccuracies or incompleteness contained in any datasheet or in any other disclosure relating to any product.

Vishay makes no warranty, representation or guarantee regarding the suitability of the products for any particular purpose or the continuing production of any product. To the maximum extent permitted by applicable law, Vishay disclaims (i) any and all liability arising out of the application or use of any product, (ii) any and all liability, including without limitation special, consequential or incidental damages, and (iii) any and all implied warranties, including warranties of fitness for particular purpose, non-infringement and merchantability.

Statements regarding the suitability of products for certain types of applications are based on Vishay's knowledge of typical requirements that are often placed on Vishay products in generic applications. Such statements are not binding statements about the suitability of products for a particular application. It is the customer's responsibility to validate that a particular product with the properties described in the product specification is suitable for use in a particular application. Parameters provided in datasheets and / or specifications may vary in different applications and performance may vary over time. All operating parameters, including typical parameters, must be validated for each customer application by the customer's technical experts. Product specifications do not expand or otherwise modify Vishay's terms and conditions of purchase, including but not limited to the warranty expressed therein.

Except as expressly indicated in writing, Vishay products are not designed for use in medical, life-saving, or life-sustaining applications or for any other application in which the failure of the Vishay product could result in personal injury or death. Customers using or selling Vishay products not expressly indicated for use in such applications do so at their own risk. Please contact authorized Vishay personnel to obtain written terms and conditions regarding products designed for such applications.

No license, express or implied, by estoppel or otherwise, to any intellectual property rights is granted by this document or by any conduct of Vishay. Product names and markings noted herein may be trademarks of their respective owners.

## Looking for pricing, stock, or lifecycle information?

Click below to explore more details on WIN SOURCE:

 [View VS-40CPQ080PBF on WIN SOURCE](#)

 [Vishay Information](#)

## Optimize Your Supply Chain with WIN SOURCE Solutions

-  Global Sourcing Solution
-  Obsolete Management
-  Cost Control Management
-  Shortage Management
-  Alternative Solution
-  Excess Inventory Management