

### Through-hole Mounting DIP Switch with High Environmental Resistance by Sealed Construction

- Sealed structure equivalent to IP64 (IEC-60529) prevents flux penetration and provides high contact reliability even in dusty locations and locations where water is used.
- Smooth, sure switching action enables comfortable operation.
- Gold-plated twin contacts ensure high reliability.

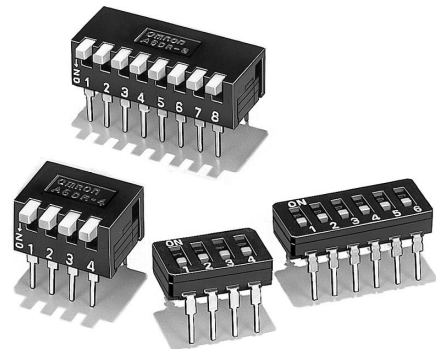

RoHS Compliant

### List of Models

Tube packaging (Slide)/ Unit box (Piano)

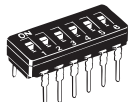
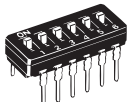
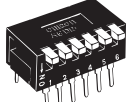
Type	Slide				Piano	
	Flat actuator		Raised actuator			
	Quantity per tube		Quantity per tube		Quantity per Unit box	
No. of poles						
2	73	<b>A6D-2100</b>	73	<b>A6D-2103</b>	100	<b>A6DR-2100</b>
3	54	<b>A6D-3100</b>	54	<b>A6D-3103</b>	—	—
4	43	<b>A6D-4100</b>	43	<b>A6D-4103</b>	50	<b>A6DR-4100</b>
5	35	<b>A6D-5100</b>	35	<b>A6D-5103</b>	—	—
6	30	<b>A6D-6100</b>	30	<b>A6D-6103</b>	50	<b>A6DR-6100</b>
7	26	<b>A6D-7100</b>	26	<b>A6D-7103</b>	—	—
8	23	<b>A6D-8100</b>	23	<b>A6D-8103</b>	50	<b>A6DR-8100</b>
9	20	<b>A6D-9100</b>	20	<b>A6D-9103</b>	—	—
10	19	<b>A6D-0100</b>	19	<b>A6D-0103</b>	50	<b>A6DR-0100</b>

Note: 1. Order in multiples of the package quantity.

2. Contact your OMRON sales representatives to request special markings or designations.

### Ratings/Characteristics

<b>Rating (resistive load)</b>	30 mA at 30 VDC 10 $\mu$ A (minimum current) at 3.5 VDC	
<b>Ambient operating temperature</b>	-20 to +70°C at 60% max. (with no icing or condensation)	
<b>Ambient operating humidity</b>	35% to 95% (at +5 to +35°C)	
<b>Insulation resistance</b>	100 M $\Omega$ min. (at 250 VDC with insulation tester)	
<b>Contact resistance (initial value)</b>	100 m $\Omega$ max.	
<b>Dielectric strength</b>	<b>Between terminals</b>	500 VAC for 1 min
<b>Vibration resistance</b>	<b>Malfunction</b>	10 to 55 Hz, 1.5-mm double amplitude
<b>Shock resistance</b>	<b>Malfunction</b>	300 m/s <sup>2</sup> min.
<b>Durability</b>	<b>Electrical</b>	2,000 operations min.
<b>Washing</b>	Possible	
<b>Degree of protection</b>	Internally sealed (IEC IP64 equivalency)	
<b>Operating force</b>	0.29 to 4.9 N {30 to 500 gf}	
<b>Weight</b>	Slide: 0.28 g (2 poles), 0.45 g (4 poles), 0.65 g (6 poles), 0.80 g (8 poles), 1.0 g (10 poles) Piano: 0.53 g (2 poles), 0.8 g (4 poles), 1.2 g (6 poles), 1.7 g (8 poles), 2.2 g (10 poles)	

**Dimensions** (Unit: mm)

**Slide**

● **Flat Actuator**

**A6D-□100**

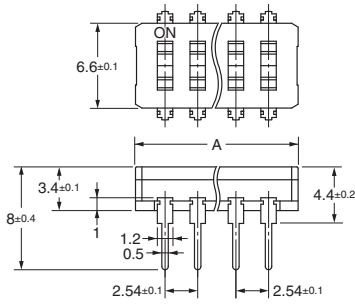
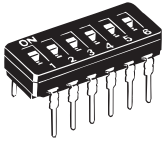

**Flat Actuator**

**Raised Actuator**

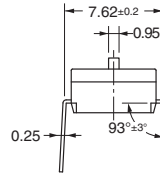

● **Raised Actuator**

**A6D-□103**

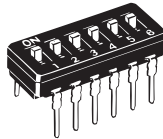

No. of poles	Model		Dimension A±0.2
	Flat Actuator	Raised Actuator	
2	A6D-2100	A6D-2103	7.1
3	A6D-3100	A6D-3103	9.7
4	A6D-4100	A6D-4103	12.2
5	A6D-5100	A6D-5103	14.7
6	A6D-6100	A6D-6103	17.3
7	A6D-7100	A6D-7103	19.8
8	A6D-8100	A6D-8103	22.4
9	A6D-9100	A6D-9103	24.9
10	A6D-0100	A6D-0103	27.4

**Piano**

**A6DR-□100**

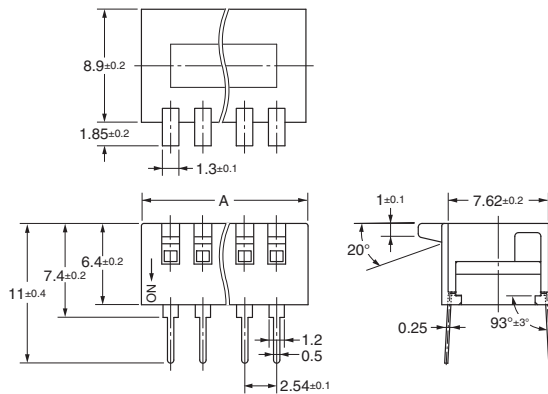
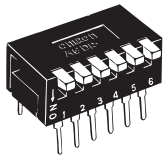

No. of poles	Model	Dimension A±0.2
2	A6DR-2100	7.1
4	A6DR-4100	12.2
6	A6DR-6100	17.3
8	A6DR-8100	22.4
10	A6DR-0100	27.4

**PCB Dimensions (Reference)**  
**(Top View)**

(Single-sided PCB, t=1.2 to 1.6)

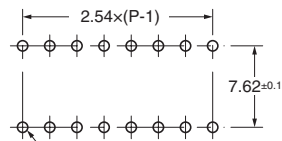

0.8 dia. (min.) holes \* P: Number of Poles

\* 0.9 dia. for automatic insertion.

**Note:** Unless otherwise specified, a tolerance of ±0.4 mm applies to all dimensions.

**Internal Connections**

**Contact Form (Top View)**

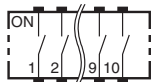

**Precautions**

Be sure to read the Safety precautions common to all DIP Switches for correct use.

- Application examples provided in this document are for reference only. In actual applications, confirm equipment functions and safety before using the product.
- Consult your OMRON representative before using the product under conditions which are not described in the manual or applying the product to nuclear control systems, railroad systems, aviation systems, vehicles, combustion systems, medical equipment, amusement machines, safety equipment, and other systems or equipment that may have a serious influence on lives and property if used improperly. Make sure that the ratings and performance characteristics of the product provide a margin of safety for the system or equipment, and be sure to provide the system or equipment with double safety mechanisms.

**Note: Do not use this document to operate the Unit.**



**OMRON Corporation**  
Electronic and Mechanical Components Company

Contact: [www.omron.com/ecb](http://www.omron.com/ecb)

Cat. No. A052-E1-08  
0117(0207)(O)

## Looking for pricing, stock, or lifecycle information?

Click below to explore more details on WIN SOURCE:

-  [View A6D-2100 on WIN SOURCE](#)
-  [Omron Information](#)

## Optimize Your Supply Chain with WIN SOURCE Solutions

-  Global Sourcing Solution
-  Obsolete Management
-  Cost Control Management
-  Shortage Management
-  Alternative Solution
-  Excess Inventory Management