

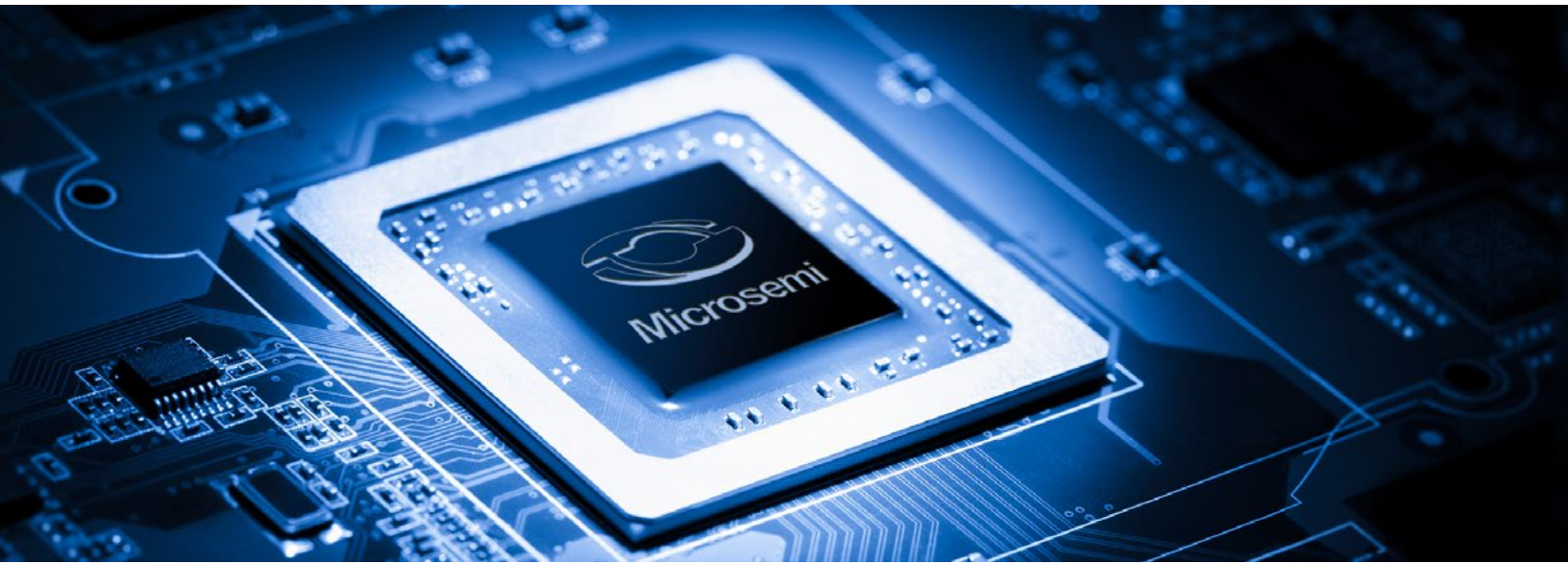

**THE DATASHEET OF
A3P1000-PQG208**



Lowest Power, Proven Security, and Exceptional Reliability



Flash FPGAs

Flash SoC FPGAs

Military FPGAs

Automotive FPGAs

Design Tools

Development Kits

Solutions

Intellectual Property



Broad Range FPGA Supplier (1-500K LE)

Features	SmartFusion ProASIC3, IGLOO	SmartFusion2 IGLOO2	PolarFire
Logic Elements	100 - 30K	5K - 150K	100K - 480K
Transceiver Rate	--	1-5 Gbps	250 Mbps-12.7 Gbps
I/O Speeds	400 Mbps LVDS	667 Mbps DDR3 750 Mbps LVDS	1600 Mbps DDR4 1.6 Gbps LVDS
DSP (18x18 Multipliers)	--	240	1480
Max RAM	144 Kb	5 Mb	33 Mb
Processor Option	Hard 100 MHz ARM Cortex-M3	Hard 166 MHz ARM Cortex-M3 Soft RISC-V	Soft RISC-V Soft ARM Cortex-M1 Hard Crypto Processor
On-board Flash	Up to 512 KB code store	Up To 512 KB code store	56 KB secure NVM
Family Type	CPLD Replacements Smallest Packages	Low Density FPGAs with more resources and lowest power	Mid-Range Density FPGAs Lowest Power, Cost Optimized

Microsemi FPGAs and SoC FPGAs

Whether you're designing at the board or system level, Microsemi's SoC FPGAs and low-power FPGAs are your best choice. The unique, flash-based technology of Microsemi FPGAs and their history of reliability sets them apart from traditional FPGAs.

Design with Microsemi's FPGAs and SoC FPGAs for today's rapidly-growing consumer and portable medical device markets, or tomorrow's environmentally friendly data centers, industrial controls, and military and commercial aircraft. Only Microsemi can meet the power, size, cost, and reliability targets that reduce time-to-market and enable long-term profitability.

Product Highlights

PolarFire FPGA	<ul style="list-style-type: none"> • Award winning cost optimized, lowest power mid-range density FPGA • 100K to 500K LEs • Transceivers up to 12.7 Gbps 	4
SmartFusion[®]2 SoC FPGA	<ul style="list-style-type: none"> • 166 MHz ARM[®] Cortex[®]-M3 processor • 5K to 150K logic elements • PCIe Gen2 hard IP and complete microcontroller subsystem 	7
IGLOO[®]2 FPGA	<ul style="list-style-type: none"> • The most feature-rich low-density FPGA • 5K to 150K logic elements • High-performance memory subsystem 	8
IGLOO FPGA	<ul style="list-style-type: none"> • 100 to 35K logic elements • Ideal for CPLD replacement • Smallest package options • High I/O-to-logic ratio 	9
ProASIC[®]3 FPGA	<ul style="list-style-type: none"> • 100 to 35K logic elements • Ideal for CPLD replacement • Smallest package options 	12
SmartFusion SoC FPGA	<ul style="list-style-type: none"> • 100 MHz ARM Cortex-M3 processor • Up to 6K logic elements, analog processing 	15
Military Products	<ul style="list-style-type: none"> • Military FPGA with up to 150K logic elements • Best-in-class security • Industry's most reliable FPGAs 	16
Automotive-Grade Products	<ul style="list-style-type: none"> • AEC-Q 100 T1 and T2 devices • 1K to 90K logic elements 	17
Design Tools	<ul style="list-style-type: none"> • Design software for Microsemi FPGAs and SoC FPGAs 	18
Development Kits	<ul style="list-style-type: none"> • PolarFire based evaluation boards • IGLOO2 & SmartFusion2 based kits 	20
Imaging and Video Solutions	<ul style="list-style-type: none"> • FMC based evaluation boards & IP 	24
Motor Control Solutions	<ul style="list-style-type: none"> • Complete solution including evaluation board, IP and software 	25
Intellectual Property Cores	<ul style="list-style-type: none"> • Microsemi intellectual property designed and optimized for use with Microsemi FPGAs 	26

For the latest device information, valid ordering codes, and details regarding previous generations of flash FPGAs, visit www.microsemi.com/fpga-soc or consult the corresponding product datasheets.

PolarFire FPGAs

PolarFire Cost-optimized FPGAs Deliver the Lowest Power at Mid-range Densities

Microsemi extends its non-volatile FPGA leadership with the PolarFire family of cost-optimized FPGAs. PolarFire FPGAs deliver up to 50% lower power than equivalent SRAM FPGAs. The devices are ideal for a wide range of applications within wireline access networks and cellular infrastructure, defense and commercial aviation markets, as well as industrial automation and IoT markets.



As a true broad-range FPGA supplier, Microsemi offers FPGA product families spanning 1K to 500K logic elements (LEs).

The devices offer unprecedented capabilities while maintaining all the advantages traditionally associated with non-volatile FPGAs such as the lowest static power, security, and single event upset (SEU) immunity.



Cost-optimized Architecture

- Transceiver performance optimized for 12.7 Gbps, which yields smaller size
- Architecture and process optimizations for specific bandwidths (10 Gbps–40 Gbps) at specific densities
- 1.6 Gbps I/Os—best-in-class hardened I/O gearing logic with CDR (supports SGMII/GbE links on these GPIOs)
- High-performance, best-in-class hardened security IP in mid-range devices

Power Optimization

- The lowest static power—28nm non-volatile process yields very low static power
- Optimized for 12.7 Gbps, which yields the lowest power
- Low power modes—Flash*Freeze yields best-in-class standby power
- Integrated hard IP—DDR PHY, PCIe endpoint/root port, crypto processor
- Total power (static and dynamic)—up to 50% lower power

Solving Key Market Issues



Communications

- Significantly improved network capacity and coverage with limited spectrum and CAPEX
- Delivers 4K video
- Lower OPEX
- IoT growth with minimal energy consumption
- Lower physical and carbon footprint



Defense

- Anti-tamper for Foreign Military Sales (FMS)
- Increasing automation in vehicles and weaponry
- Enhancing operator situational awareness
- Battlefield portability and increased mission life
- Increased cybersecurity
- Supply chain security



Industrial

- Increased networking of factory automation
- M2M—growth of additional sensors and nodes
- Rise of cloud services requiring decentralized, secure computing
- Portability becoming more prevalent
- Cyber security threats
- Functional safety

PolarFire Architecture

PolarFire FPGAs Deliver Up to 500K Logic Elements, 12.7G Transceivers at 50% Lower Power

- High-speed serial connectivity with built-in multi-gigabit/multi-protocol transceivers from 250 Mbps to 12.7 Gbps
- Up to 481K logic elements consisting of a 4-input look-up table (LUT) with a fractureable D-type flip-flop
- Up to 33 Mbits of RAM
- Up to 1480 18x18 multiply accumulate blocks with hardened pre-adders
- Integrated dual PCIe for up to x4 Gen 2 endpoint (EP) and root port (RP) designs
- High-speed I/O (HSIO) supporting up to 1600 Mbps DDR4, 1333 Mbps DDR3L, and 1333 Mbps LPDDR3/DDR3 memories with integrated I/O gearing
- General purpose I/O (GPIO) supporting 3.3 V built-in CDR to support SGMII for serial gigabit Ethernet, 1067 Mbps DDR3, and 1600 Mbps LVDS I/O speed with integrated I/O gearing logic

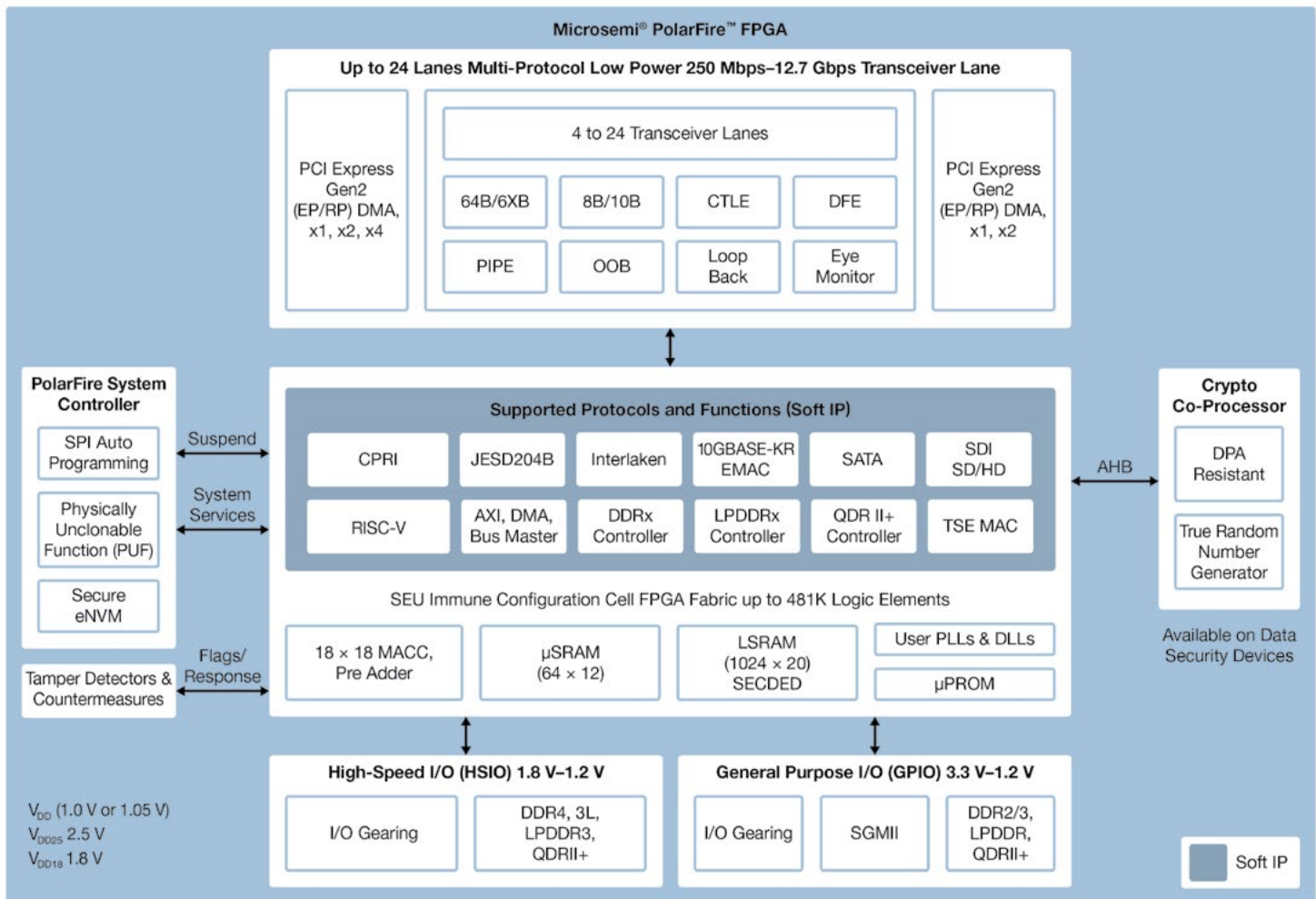

Reliability Features

- SEU immune FPGA configuration cells
- Built-in SECEDED and memory interleaving on LSRAMs
- System controller suspend mode for safety-critical designs

Security Features

- Cryptography Research Incorporated (CRI)-patented differential power analysis (DPA) bitstream protection
- Integrated physically unclonable function (PUF)
- 56 Kbytes of secure eNVM (sNVM)
- Built-in tamper detectors and countermeasures
- Integrated Athena TeraFire EXP5200B Crypto Co-processor, Suite B-capable
- Digest integrity check for FPGA, μPROM, and sNVM
- True random number generator
- CRI DPA countermeasure pass through license

PolarFire FPGAs

Cyber Security is the #1 Concern for Connected Devices on the Network Edge

It is not enough for today's demanding applications to meet the functional requirements of their design—they must do so in a secured way. Security starts during silicon manufacturing and continues through system deployment and operations. Microsemi's PolarFire FPGAs represent the industry's most advanced secure programmable FPGAs.

Microsemi Security Leadership

Security Advantage	Low Density		Mid-Range	
	Microsemi	Competition	Microsemi	Competition
Prevent overbuilding and cloning	Best Low-density Security	N/A	Best Security in the Industry	N/A
Full design IP protection		N/A		Weak
Root of trust		N/A		N/A
Secure data communications		N/A		Weak
Anti-tamper		N/A		N/A

“The number of IoT sensors is expected to approach 30 billion in 5 years – and each unit is a potential entry point for cyber-criminals” – *The Economist Intelligence Unit, 4/11/2016*

“Some call cybercrime the greatest transfer of wealth in human history” – *The Center of Strategic and International Studies, July 2013, The Economic Impact of Cybercrime*

Feature and Packaging Overview of the PolarFire FPGA Family

Features		PolarFire FPGAs			
		MPF100T	MPF200T	MPF300T	MPF500T
FPGA fabric	Logic elements (4 LUT + DFF)	109	192	300	481
	Math blocks (18 x 18 MACC)	336	588	924	1480
	LSRAM blocks (20 kbits)	352	616	952	1520
	μSRAM blocks (64 x 12)	1008	1764	2772	4440
	Total RAM (Mbits)	7.6	13.3	20.6	33
	μPROM (Kbits, 9-bit bus)	297	297	459	513
	User DLLs/PLLs	8	8	8	8
High-speed I/O	250 Mbps to 12.7 Gbps transceiver lanes	8	16	16	24
	PCIe Gen2 endpoints/root ports	2	2	2	2
Total I/Os	Total user I/Os	284	368	512	584
Packaging	Type/size/pitch	Total user I/Os (HSIO/GPIO)/transceivers			
	FCSG325 (11 mm x 11 mm, 11 mm x 14.5 mm*, 0.5 mm)	170(84/86)/4	170(84/86)/4*		
	FCSG536 (16 mm x 16 mm, 0.5 mm)		300(120/180)/4	300(120/180)/4	
	FCVG484 (19 mm x 19 mm, 0.8 mm)	284(120/164)/4	284(120/164)/4	284(120/164)/4	
	FCG484 (23 mm x 23 mm, 1.0 mm)	244(96/148)/8	244(96/148)/8	244(96/148)/8	
	FCG784 (29 mm x 29 mm, 1.0 mm)		368(132/236)/16	388(156/232)/16	388(156/232)/16
	FCG1152 (35 mm x 35 mm, 1.0 mm)		512(276/236)/16	584(324/260)/24	

Devices in the same package and family type are pin-compatible.
*Wider package dimension applies to the MPF200 device only.

SmartFusion2 SoC FPGAs

More Resources in Low-Density Devices with ARM Cortex-M3 Processor

SmartFusion2 SoC FPGAs deliver more resources in low-density devices with low power requirements, proven security, and exceptional reliability. These devices are ideal for general purpose functions such as Gigabit Ethernet or dual-PCI Express control planes, bridging functions, input/output (I/O) expansion and conversion, video/image processing, system management, and secure connectivity. Microsemi SoC FPGAs are used by customers in Communications, Industrial, Medical, Defense, and Aviation markets.

- Embedded ARM Cortex-M3 microcontroller subsystem (MSS)
- Embedded DDR3 memory controllers
- Instant-on
- NRBG, AES-256, SHA-256, ECC cryptographic engine
- PCIe Gen2 endpoints starting at 10K logic elements
- Small packages
- Zero FIT FPGA configuration cells
- User physically unclonable function (PUF)
- 1 mW in Flash*Freeze mode
- SECEDED memory protection
- CRI DPA pass-through license

SmartFusion2 Devices

SmartFusion2 Devices	Features	M2S005	M2S010	M2S025	M2S050	M2S060	M2S090	M2S150	
Logic/DSP	Maximum logic elements (4LUT + DFF)	6,060	12,084	27,696	56,340	56,520	86,184	146,124	
	Mathblocks (18 x 18)	11	22	34	72	72	84	240	
	Fabric interface controllers (FICs)	1		2		1		2	
	PLLs and CCCs	2		6				8	
	Security	AES256, SHA256, RNG				AES256, SHA256, RNG, ECC, PUF			
MSS	Cortex-M3 + instruction cache	Yes							
	eNVM (KB)	128	256				512		
	eSRAM (KB)	64							
	eSRAM (KB) non-SECEDED	80							
	CAN, 10/100/1000 Ethernet, HS USB					1 each			
Fabric memory	Multi-mode UART, SPI, I ² C, timer	2 each							
	LSRAM 18K blocks	10	21	31	69		109	236	
	uSRAM 1K blocks	11	22	34	72		112	240	
High-speed	Total RAM (kbits)	191	400	592	1,314		2,074	4,488	
	DDR controllers (count x width)	1 x 18			2 x 36		1 x 18		2 x 36
	SERDES lanes	0	4		8		4		16
User I/O	PCIe endpoints	0	1		2			4	
	MSIO (3.3 V)	115	123	157	139	271	309	292	
	MSIOD (2.5 V)	28	40		62		40		106
	DDRIO (2.5 V)	66	70		176		76		176
	Total user I/Os	209	233	267	377	387	425	574	

I/Os per Package

Package type	Package Options																			
	FCS(G)325		VF(G)256		FCS(G)536		VF(G)400		FCV(G)484		TQ(G)144		FG(G)484		FG(G)676		FG(G)896		FC(G)1152	
Pitch (mm)	0.5		0.8		0.5		0.8		0.5		1.0		1.0		1.0		1.0		1.0	
Length x width (mm)	11 x 11		14 x 14		16 x 16		17 x 17		19 x 19		20 x 20		23 x 23		27 x 27		31 x 31		35 x 35	
Device	I/O	Lanes	I/O	Lanes	I/O	Lanes	I/O	Lanes	I/O	Lanes	I/O	Lanes	I/O	Lanes	I/O	Lanes	I/O	Lanes	I/O	Lanes
M2S005 (S)			161				171				84		209							
M2S010 (S/T/Ts)			138	2			195	4			84		233	4						
M2S025 (T/Ts)	180	2	138	2			207	4					267	4						
M2S050 (T/Ts)	200	2					207	4					267	4			377	8		
M2S060 (T/Ts)	200	2					207	4					267	4	387	4				
M2S090 (T/Ts)	180	4											267	4	425	4				
M2S150 (T/Ts)					293	4			248	4									574	16

Notes:
 1. M2S090 FCSG325 package dimension are 11 x 13.5. 2. Highlighted devices can migrate vertically in the same package. 3. (G) indicates that the package is RoHS 6/6 compliant/Pb-free.

IGLOO2 FPGAs

More Resources in Low-Density Devices with High-Performance Memory Subsystem

IGLOO2 FPGAs deliver more resources in low-density devices with low power requirements, proven security, and exceptional reliability. These devices are ideal for general purpose functions such as Gigabit Ethernet or dual-PCI Express control planes, bridging functions, input/output (I/O) expansion and conversion, video/image processing, system management, and secure connectivity. Microsemi FPGAs are used by customers in Communications, Industrial, Medical, Defense, and Aviation markets.

- High-performance memory subsystem
- PCIe Gen2 endpoints starting at 10K logic elements
- Embedded DDR3 memory controllers
- SECCDED memory protection
- 1 mW in Flash*Freeze mode
- Instant-on
- Zero FIT FPGA configuration cells
- CRI DPA pass-through license
- Small packages
- NRBG, AES-256, SHA-256, ECC cryptographic engine
- User physically unclonable function (PUF)

IGLOO2 Devices

IGLOO2 Devices	Features	M2GL005	M2GL010	M2GL025	M2GL050	M2GL060	M2GL090	M2GL150	
Logic/DSP	Maximum logic elements (4LUT + DFF)	6,060	12,084	27,696	56,340	56,520	86,184	146,124	
	Mathblocks (18 × 18)	11	22	34	72	72	84	240	
	PLLs and CCCs	2		6				8	
	SPI/HPDMA/PDMA	1 each							
	Fabric interface controllers (FICs)	1		2		1		2	
Memory	Data security	AES256, SHA256, RNG				AES256, SHA256, RNG, ECC, PUF			
	eNVM (KB)	128	256				512		
	LSRAM 18K blocks	10	21	31	69		109	236	
	uSRAM 1K blocks	11	21	34	72		112	240	
	eSRAM (KB)	64							
High-speed	Total RAM (kbits)	703	912	1104	1826		2586	5000	
	DDR controllers (count × width)	1 × 18			2 × 36		1 × 18		2 × 36
	SERDES lanes	0	4		8	4			16
	PCIe endpoints	0	1		2			4	
User I/O	MSIO (3.3 V)	115	123	157	139	271	309	292	
	MSIOD (2.5 V)	28	40		62	40		106	
	DDRIO (2.5 V)	66	70		176	76		176	
	Total user I/Os	209	233	267	377	387	425	574	
Grades	Commercial (C), Industrial (I), Military (M)	C, I		C, I, M					

Notes:
 1. Total logic may vary based on utilization of DSP and memories in your design. Please see the [IGLOO2 and SmartFusion2 Fabric User Guide](#) for details. 2. Feature availability is package dependent.

I/Os per Package

Package type	Package Options																			
	FCS(G)325		VF(G)256		FCS(G)536		VF(G)400		FCV(G)484		TQ(G)144		FG(G)484		FG(G)676		FG(G)896		FC(G)1152	
Pitch (mm)	0.5		0.8		0.5		0.8		0.5		1.0		1.0		1.0		1.0		1.0	
Length × width (mm)	11x11		14x14		16x16		17x17		19x19		20x20		23x23		27x27		31x31		35x35	
Device	I/O	Lanes	I/O	Lanes	I/O	Lanes	I/O	Lanes	I/O	Lanes	I/O	Lanes	I/O	Lanes	I/O	Lanes	I/O	Lanes	I/O	Lanes
M2GL005 (S)			161				171				84		209							
M2GL010 (S/T/TS)			138	2			195	4			84		233	4						
M2GL025 (T/TS)	180	2	138	2			207	4					267	4						
M2GL050 (T/TS)	200	2					207	4					267	4			377	8		
M2GL060 (T/TS)	200	2					207	4					267	4	387	4				
M2GL090 (T/TS)	180	4											267	4	425	4				
M2GL150 (T/TS)					293	4			248	4									574	16

Notes:
 1. M2GL090 FCS325 package dimension are 11 x 13.5. 2. Highlighted devices can migrate vertically in the same package. 3. (G) indicates that the package is RoHS 6/6 compliant/Pb-free

IGLOO Family: IGLOO/e FPGAs

The Ideal Low-Power, Programmable Solution for CPLD Replacement

The IGLOO family of reprogrammable and full-featured flash FPGAs is designed to meet the low-power and area requirements of today's portable electronics. Based on nonvolatile flash technology, the 1.2 V to 1.5 V operating voltage family offers the industry's lowest power consumption—as low as 5 μ W. The IGLOO family supports up to 35K logic elements with up to 504 kbits of true dual-port SRAM, up to six embedded PLLs, and up to 620 user I/Os. Low-power applications that require 32-bit processing can use the ARM Cortex-M1 processor without license fees or royalties in M1 IGLOO devices. Developed specifically for implementation in FPGAs, Cortex-M1 devices offer an optimal balance between performance and size to minimize power consumption.

- Low-power FPGAs
- Flash*Freeze technology for low power consumption
- 1.2 V core and I/O voltage
- Instant-on
- AES-protected in-system programming (ISP)
- User nonvolatile FlashROM

IGLOO/e Devices

IGLOO devices	Features	AGL030	AGL060	AGL125	AGL250	AGL400	AGL600	AGL1000	AGLE600	AGLE3000
ARM-Enabled IGLOO ¹ devices					M1AGL250		M1AGL600	M1AGL1000		M1AGLE3000
Logic	Logic elements (approximate)	330	700	1,500	3,000	5,000	7,000	11,000	7,000	35,000
	System gates	30,000	60,000	125,000	250,000	400,000	600,000	1,000,000	600,000	3,000,000
	VersaNet globals ³	6	18	18	18	18	18	18	18	18
	Flash*Freeze mode (typical, μ W)	5	10	16	24	32	36	53	49	137
	AES-protected ISP ¹		Yes	Yes	Yes	Yes	Yes	Yes	Yes	Yes
Fabric memory	Integrated PLLs with CCC ²		1	1	1	1	1	1	6	6
	RAM (1,024 bits)		18	36	36	54	108	144	108	504
	RAM blocks (4,608 bits)		4	8	8	12	24	32	24	112
	FlashROM kbits (1,024 bits)	1	1	1	1	1	1	1	1	1
User I/O	I/O banks	2	2	2	4	4	4	4	8	8
	Maximum user I/Os	81	96	133	143	194	235	300	270	620

Notes:
 1. AES is not available for Cortex-M1 IGLOO devices. 2. AGL060 in CS121 does not support the PLL. 3. Six chip (main) and twelve quadrant global networks are available for AGL060 devices and above.

I/Os per Package

IGLOO/e Devices	I/O Package	QNG48	UCG81	CSG81	CS(G)121	VQ(G)100	CS(G)196	FG(G)144	FG(G)256 ³	CS(G)281	FG(G)484 ³
	Pitch (mm)	0.4	0.4	0.5	0.5	0.5	0.5	1.0	1.0	0.5	1.0
	Length x Width (mm)	6 x 6	4 x 4	5 x 5	6 x 6	16 x 16	8 x 8	13 x 13	17 x 17	10 x 10	23 x 23
AGL030	Single-end I/O	34	66	66		77					
AGL060	Single-end I/O					71					
AGL125	Single-end I/O				96	71	133	97			
AGL250/ M1AGL250	Single-end I/O ²					68	143 ¹				
	Differential I/O					13	35 ¹				
AGL400	Single-end I/O ²						143		178		
	Differential I/O						35		38		
AGL600/ M1AGL600	Single-end I/O ²							97	177	215	
	Differential I/O							25	43	53	
AGL1000/ M1AGL1000	Single-end I/O ²							97	177	215	300
	Differential I/O							25	44	53	74
AGLE600	Single-end I/O ²								165		
	Differential I/O								79		
AGLE3000/ M1AGLE3000	Single-end I/O ²										341
	Differential I/O										168

Notes:
 1. The M1AGL250 device does not support CS196 package. 2. Each used differential pair reduces the number of single-end I/Os available by two. 3. FG256 and FG484 are footprint-compatible packages.

IGLOO Family: IGLOO nano FPGAs

The Industry's Lowest-Power, Smallest-Size Solution

IGLOO nano products offer groundbreaking possibilities in power, size, lead-times, operating temperature ranges, and cost. Available in logic densities from 100–3K logic elements, 1.2 V to 1.5 V IGLOO nano devices have been designed for high-volume applications where power and size are the key decision criteria. IGLOO nano devices are perfect ASIC or ASSP replacements, yet retain the historical FPGA advantages of flexibility and quick time-to-market in low-power and small footprint profiles.

- Ultra low power in Flash*Freeze mode, as low as 2 μ W
- Small footprint packages from 14 mm \times 14 mm to 3 mm \times 3 mm
- Enhanced commercial temperature
- 1.2 V to 1.5 V single voltage operation
- Enhanced I/O features
- Embedded SRAM and non-volatile memory (NVM)
- ISP and security
- Instant-on

IGLOO nano Devices

IGLOO nano Devices	Features	AGLN010	AGLN020	AGLN060	AGLN125	AGLN250
Logic	Logic elements (approximate)	100	200	700	1,500	3,000
	System gates	10,000	20,000	60,000	125,000	250,000
	VersaNet globals	4	4	18	18	18
	Flash*Freeze mode (typical, μ W)	2	4	10	16	24
	AES-protected ISP			Yes	Yes	Yes
	Integrated PLL in CCCs ¹			1	1	1
Fabric memory	RAM kbits (1,024 bits)			18	36	36
	4,608-bit blocks			4	8	8
	FlashROM kbits (1,024 bits)	1	1	1	1	1
User I/O	I/O banks	2	3	2	2	4
	Maximum user I/Os (packaged device)	34	52	71	71	68

Notes:

1. AGLN060, AGLN125 and AGLN250 in the CS(G)81 package do not support PLLs.

I/Os per Package

I/O Packages	UCG36	QNG48	QNG68	CSG81	VQ(G)100 ²
Pitch (mm)	0.4	0.4	0.4	0.5	0.5
Length \times width (mm)	3 \times 3	6 \times 6	8 \times 8	5 \times 5	16 \times 16
AGLN010	23	34			
AGLN020			49	52	
AGLN060				60	71
AGLN125				60	71
AGLN250				60	68

Notes:

1. IGLOO nano devices do not support differential I/Os.

2. (G) indicates that the package is RoHS 6/6 compliant/Pb-free.

IGLOO Family: IGLOO PLUS FPGAs

The Low-Power FPGA with Enhanced I/O Capabilities

IGLOO PLUS products deliver low power consumption and enhanced I/Os in a feature-rich programmable device, offering more I/Os per logic element than IGLOO devices, and supporting independent Schmitt trigger inputs, hot-swapping, and Flash*Freeze bus hold. Ranging from 330–1.5K logic elements, 1.2V to 1.5V IGLOO PLUS devices have been optimized to meet the needs of I/O-intensive, power-conscious applications that require exceptional features.

- I/O-optimized FPGA
- Low power in Flash*Freeze mode, as low as 5 μ W
- Small footprint and low-cost packages
- Reprogrammable flash technology
- 1.2 V to 1.5 V single voltage operation
- Embedded SRAM NVM
- AES-protected ISP
- Instant-on

IGLOO PLUS Devices

IGLOO PLUS Devices	Features	AGLP030	AGLP060	AGLP125
Logic	Logic elements (approximate)	330	7,000	1,500
	System gates	30,000	60,000	125,000
	VersaNet globals	6	18	18
	Flash*Freeze mode (typical, μ W)	5	10	16
	AES-protected ISP		Yes	Yes
Fabric memory	Integrated PLL in CCCs ¹		1	1
	RAM (1,024 bits)		18	36
	4,608-bit blocks		4	8
	FlashROM kbits (1,024 bits)	1	1	1
User I/O	I/O banks	4	4	4
	Maximum user I/Os (packaged device)	120	157	212

Notes:
1. AGLP060 in CS(G)201 does not support the PLL.

I/Os per Package

IGLOO PLUS Devices	I/O Package	CS(G)201	CS(G)281	CS(G)289	VQ(G)128	VQ(G)176
	Pitch (mm)	0.5	0.5	0.8		0.4
	Length x width (mm)	8 x 8	10 x 10	14 x 14		22 x 22
AGLP030	Single-end I/O	120		120	101	
AGLP060	Single-end I/O	157		157		137
AGLP125	Single-end I/O		212	212		

Notes:
1. IGLOO Plus devices do not support differential I/Os. 2. (G) indicates that the package is RoHS 6/6 compliant/Pb-free.

ProASIC3 Family: ProASIC3/E FPGAs

Low-Density CPLD Replacement FPGA

The ProASIC3 series of flash FPGAs offers a breakthrough in power, performance, density, and features for today's most demanding high-volume applications. ProASIC3 devices support the ARM Cortex-M1 processor, offering the benefits of programmability and time-to-market at low cost. ProASIC3 devices are based on nonvolatile flash technology and support 330–35K logic elements and up to 620 high-performance I/Os. For automotive applications, selected ProASIC3 devices are qualified to AEC-Q100 and are available with AEC T1 screening and PPAP documentation.

- 1.5 V single voltage operation
- Instant-on
- Advanced I/O standards
- 350 MHz system performance
- Configuration memory error immune
- Secure ISP

ProASIC3/E Devices

ProASIC3/E Devices	Features	A3P030	A3P060 ²	A3P125 ²	A3P250 ²	A3P400	A3P600	A3P1000 ²	A3PE600	A3PE1500	A3PE3000
ARM Cortex-M1 Devices					M1A3P250	M1A3P400	M1A3P600	M1A3P1000		M1A3PE1500	M1A3PE3000
Logic	Logic elements (approximate)	330	700	1,500	3,000	5,000	7,000	11,000	7,000	16,000	35,000
	System gates	30,000	60,000	125,000	250,000	400,000	600,000	1,000,000	600,000	1,500,000	3,000,000
	VersaNet globals ³	6	18	18	18	18	18	18	18	18	18
	AES-protected ISP ¹		Yes	Yes	Yes	Yes	Yes	Yes	Yes	Yes	Yes
	Integrated PLL in CCCs		1	1	1	1	1	1	6	6	6
Fabric memory	RAM (1,024 bits)		18	36	36	54	108	144	108	270	504
	4,608-bit blocks		4	8	8	12	24	32	24	60	112
	FlashROM kbits (1,024 bits)	1	1	1	1	1	1	1	1	1	1
User I/O	I/O banks	2	2	2	4	4	4	4	8	8	8
	Maximum user I/Os	81	96	133	157	194	235	300	270	444	620

Notes:
 1. AES is not available for ARM Cortex-M1 ProASIC3 devices. 2. Available as automotive "T" grade 3. Six chip (main) and three quadrant global networks are available for A3P060 and above.

I/Os per Package

ProASIC3	I/O Type	QNG48	QNG68	VQ(G)100	TQ(G)144	PQ(G)208	FG(G)144	FG(G)256	FG(G)324	FG(G)484	FG(G)676	FG(G)896
	Pitch (mm)	0.4	0.4	0.5	0.5	0.5	1.0	1.0	1.0	1.0	1.0	1.0
	Length x width (mm)	6 x 6	8 x 8	16 x 16	20 x 20	30.6 x 30.6	13 x 13	17 x 17	19 x 19	23 x 23	27 x 27	31 x 31
A3P030	Single-end I/O	34	49	77								
A3P060	Single-end I/O			71	91		96					
A3P125	Single-end I/O			71	100	133	97					
A3P250/ M1A3P250	Single-end I/O			68			97	157				
	Differential I/O			13			24	38				
A3P400/ M1A3P400	Single-end I/O					151	97	178				
	Differential I/O					34	25	38				
A3P600/ M1A3P600	Single-end I/O					154	97	177		235		
	Differential I/O					35	25	43		60		
A3P1000/ M1A3P1000	Single-end I/O					154	97	177		300		
	Differential I/O					35	25	44		74		
A3PE600	Single-end I/O							165		270		
	Differential I/O							79		135		
A3PE1500/ M1A3PE1500	Single-end I/O					147				280	444	
	Differential I/O					65				139	222	
A3PE3000/ M1A3PE3000	Single-end I/O					147			221	341		620
	Differential I/O					65			110	168		310

Notes:
 1. (G) indicates that the package is RoHS 6/6 compliant/Pb-free.

ProASIC3 Family: ProASIC3 nano FPGAs

Low-Density CPLD Replacement FPGA with Small Package Footprint

Microsemi's innovative ProASIC3 nano devices bring a new level of value and flexibility to high-volume markets. When measured against the typical project metrics of performance, cost, flexibility, and time-to-market, ProASIC3 nano devices provide an attractive alternative to ASICs and ASSPs in fast-moving or highly competitive markets. Customer-driven total-system cost reduction was a key design criteria for the ProASIC3 nano program. Single-chip implementation and a broad selection of small footprint packages contribute to lower total system costs.

- 1.5 V core for low power
- Configuration memory error immune
- Enhanced I/O features
- 350 MHz system performance
- Enhanced commercial temperature
- ISP and security

ProASIC3 nano Devices

ProASIC3 nano Devices	Features	A3PN010	A3PN020	A3PN060	A3PN125	A3PN250
Logic	Logic elements (approximate)	100	200	700	1,500	3,000
	System gates	10,000	20,000	60,000	125,000	250,000
	VersaNet globals	4	4	18	18	18
	AES-protected ISP			Yes	Yes	Yes
	Integrated PLL in CCCs			1	1	1
Fabric memory	RAM (1,024 bits)			18	36	36
	4,608-bit blocks			4	8	8
	FlashROM kbits (1,024 bits)	1	1	1	1	1
User I/O	I/O banks	2	3	2	2	4
	Maximum user I/Os (packaged device)	34	49	71	71	68

I/Os per Package

I/O Packages	QNG48	QNG68	VQ(G)100 ¹
Pitch (mm)	0.4	0.4	0.5
Length × width (mm)	6 × 6	8 × 8	16 × 16
A3PN010	34		
A3PN020		49	
A3PN060			71
A3PN125			71
A3PN250			68

Notes:

1. (G) indicates that the package is RoHS 6/6 compliant/Pb-free.

2. ProASIC3 nano devices do not support differential I/Os.

ProASIC3 Family: ProASIC3L FPGAs

Low-Density, Low-Power CPLD Replacement FPGA

ProASIC3L FPGAs feature lower dynamic and static power requirements than the previous generation of ProASIC3 FPGAs, and lower power requirements by orders of magnitude than SRAM competitors, combining dramatically reduced power consumption with up to 350 MHz operation. The ProASIC3L family also supports the free implementation of an FPGA-optimized 32-bit ARM Cortex-M1 processor, enabling system designers to select the Microsemi flash FPGA solution that best meets their speed and power requirements, regardless of application or volume. Optimized software tools using power-driven layout (PDL) provide instant power reduction capabilities.

- Low power 1.2 V to 1.5 V core operation
- 700 Mbps DDR, LVDS capable I/Os
- Up to 350 MHz system performance
- Configuration memory error immune
- ISP and security
- Flash*Freeze technology for low power

ProASIC3L Low-Power Devices

ProASIC3L Devices	Features	A3P600L	A3P1000L	A3PE3000L
ARM Cortex-M1 Devices ¹		M1A3P600L	M1A3P1000L	M1A3PE3000L
Logic	Logic elements (approximate)	7,000	11,000	35,000
	System gates	600,000	1,000,000	3,000,000
	VersaNet globals	18	18	18
	AES-protected ISP ²	Yes	Yes	Yes
	Integrated PLL in CCCs ³	1	1	6
Fabric memory	RAM (1,024 bits)	108	144	504
	4,608-bit blocks	24	32	112
	FlashROM kbits (1,024 bits)	1	1	1
User I/O	I/O banks	4	4	8
	Maximum user I/Os (packaged device)	235	300	620

Notes:

1. Refer to the Cortex-M1 product brief for more information.
2. AES is not available for Cortex-M1 ProASIC3L devices.
3. For the A3PE3000L, the PQ208 package has six CCCs and two PLLs.

I/Os per Package

ProASIC3L Devices	I/O Type	PQ(G)208	FG(G)144	FG(G)256	FG(G)324	FG(G)484	FG(G)896
	Pitch (mm)	0.5	1.0	1.0	1.0	1.0	1.0
	Length × width (mm)	30.6 × 30.6	13 × 13	17 × 17	19 × 19	23 × 23	31 × 31
A3P600L/ M1A3P600L	Single-end I/O		97			235	
	Differential I/O		25			60	
A3P1000L/ M1A3P1000L	Single-end I/O		97	177			
	Differential I/O		25	44			
A3PE3000L/ M1A3PE3000L	Single-end I/O	147			221	341	620
	Differential I/O	65			110	168	310

Notes:

1. (G) indicates that the package is RoHS 6/6 compliant/Pb-free.

SmartFusion SoC FPGAs

SmartFusion SoCs integrate an FPGA fabric, an ARM Cortex-M3 processor, and a programmable analog compute engine (ACE), offering full customization, IP protection, and ease-of-use. Based on Microsemi's proprietary flash process, SmartFusion SoCs are ideal for hardware and embedded designers who need a true system-on-chip that gives more flexibility than traditional fixed-function microcontrollers without the excessive cost of soft processor cores on traditional FPGAs.

- Available in commercial, industrial, and military grades
- Hard 100 MHz 32-bit ARM Cortex-M3 CPU
- Multi-layer AHB communications matrix with up to 16 Gbps throughput
- 10/100 Ethernet MAC
- Two peripherals of each type: SPI, I2C, UART, and 32-bit timers
- Up to 512 KB flash and 64 KB SRAM
- External memory controller (EMC)
- 8-channel DMA controller
- Integrated analog-to-digital converters (ADCs) and digital-to-analog converters (DACs) with 1 % accuracy
- On-chip voltage, current, and temperature monitors
- Up to ten 15 ns high-speed comparators
- Analog compute engine (ACE) offloads CPU from analog processing
- Up to 35 analog I/Os and 169 digital GPIOs

SmartFusion Devices

SmartFusion Devices	Features	A2F200	A2F500
Logic	Logic elements (approximate)	2,000	6,000
	System gates	200,000	500,000
	RAM blocks (4,608 bits)	8	24
Microcontroller subsystem (MSS)	Flash (KB)	256	512
	SRAM (KB)	64	64
	Cortex-M3 with memory protection unit (MPU)	Yes	Yes
	10/100 Ethernet MAC	Yes	Yes
	External memory controller (EMC)	26-bit address, 16-bit data	26-bit address, 16-bit data ¹
	DMA	8 Ch	8 Ch
	I2C	2	2
	SPI	2	2
	16550 UART	2	2
	32-bit timer	2	2
	PLL	1	2 ²
	32 kHz low power oscillator	1	1
	100 MHz on-chip RC oscillator	1	1
	Main oscillator (32 KHz to 20 MHz)	1	1
Programmable analog	ADCs (8-/10-/12-bit SAR)	2	3 ⁴
	DACs (12-bit sigma-delta)	2	3 ⁴
	Signal conditioning blocks (SCBs)	4	5 ⁴
	Comparators ³	8	10 ⁴
	Current monitors ³	4	5 ⁴
	Temperature monitors ³	4	5 ⁴
	Bipolar high voltage monitors ³	8	10 ⁴

Notes:

1. Not available on A2F500 for the PQ208 package and A2F060 for the TQ144 package.
2. Two PLLs are available in CS288 and FG484, one PLL in FG256 and PQ208.
3. These functions share I/O pins and may not all be available at the same time. See the "Analog Front-End Overview" section in the [SmartFusion Programmable Analog User's Guide](#) for details.
4. Available on FG484 only. PQ208, FG256 and CS288 packages offer the same programmable analog capabilities as A2F200.

Package I/Os: MSS + FPGA I/Os

Device	A2F200 ²				A2F500 ²			
	PQ(G)208	CS(G)288	FG(G)256	FG(G)484	PQ(G)208	CS(G)288	FG(G)256	FG(G)484
Pitch (mm)	0.5	0.5	1.0	1.0	0.5	0.5	1.0	1.0
Length x width (mm)	30.6 x 30.6	11 x 11	17 x 17	23 x 23	30.6 x 30.6	11 x 11	17 x 17	23 x 23
Direct analog inputs	8	8	8	8	8	8	8	12
Shared analog inputs ¹	16	16	16	16	16	16	16	20
Total analog input	24	24	24	24	24	24	24	32
Total analog output	1	2	2	2	1	2	2	3
MSS I/Os ⁵	22	31	25	41	22	31	25	41
FPGA I/Os	66	78	66	94	66 ³	78	66	128
Total I/Os	113	135	117	161	113	135	117	204

Notes:

1. There are no LVTTTL-capable direct inputs available on A2F060 devices.
2. These pins are shared between direct analog inputs to the ADCs and voltage/current/temperature monitors.
3. EMC is not available on the A2F500, PQ208, and A2F060 TQ144 package.
4. 10/100 Ethernet MAC is not available for A2F060.
5. 16 MSS I/Os are multiplexed and can be used as FPGA I/Os, if not required for MSS. These I/Os support Schmitt triggers, and support only LVTTTL and LVCMOS (1.5 V/1.8 V/2.5 V/3.3 V) standards.
6. (G) indicates that the package is RoHS 6/6 compliant/Pb-free.

Military Products

FPGAs for Military Applications

For over 25 years, Microsemi has been the leader for high reliability defense applications. Microsemi FPGAs are qualified to Mil Std 883 Class B and QML class Q. Based on flash architecture, Microsemi offers the industry's most reliable and low-power FPGAs and SoC FPGAs. Military grade FPGAs are available in IGLOO2, ProASICPlus, and ProASIC3/EL device families, and SoC FPGAs are available in SmartFusion2, SmartFusion, and Fusion device families. In addition to the advantages of the mainstream FPGAs, SoC FPGAs have an embedded ARM Cortex-M3 microcontroller on-chip. SmartFusion and Fusion devices integrate configurable analog peripherals to yield a true system-on-chip solution.

- Tested for high reliability at temperature range of -55° C to 125° C
- Product longevity
- ISO-9001 and AS-9100-certified quality management system
- PCI Express Gen1 endpoints
- Instant-on
- Small packages
- Zero FIT FPGA configuration cells
- SECEDED memory protection
- Built-in tamper detection and zeroization capability
- NRBG, AES-256, SHA-256, and ECC cryptographic engine
- User physically unclonable function (PUF)
- CRI DPA pass-through license
- Lowest-power operation
- Embedded ARM Cortex-M3 microcontroller subsystem

Military SmartFusion2 and IGLOO2 I/Os per Package

Package Type	Package Options			
	FG(G)484		FC(G)1152	
Pitch (mm)	1.0		1.0	
Length x width (mm)	23 x 23		35 x 35	
Device	I/O	Lanes	I/O	Lanes
M2S010/M2GL010 (T/TS)	233	4		
M2S025/M2GL025 (T/TS)	267	4		
M2S050/M2GL050 (T/TS)	267	4		
M2S060/M2GL060 (T/TS)	267	4		
M2S090/M2GL090 (T/TS)	267	4		
M2S150/M2GL150 (T/TS)			574	16

Notes:

1. Can migrate vertically in the same package.
2. Gold wire bonds are available for the FG484 package by appending X399 to the part number when ordering (for example, M2S090 (T/TS)-1FG484MX399).
3. All the packages are available with lead and lead free. (G) indicates that the package is RoHS 6/6 compliant/Pb-free.

Military SmartFusion, ProASIC3, and Fusion I/Os per Package

Devices	I/O Type	VQ(G)100	PQ(G)208	FG(G)144	FG(G)256	FG(G)484	FG(G)896
	Pitch (mm)	0.5	0.5	1.0	1.0	1.0	1.0
	Length x width (mm)	16 x 16	30.6 x 30.6	13 x 13	17 x 17	23 x 23	31 x 31
A3P250	Single-end I/O	68					
	Differential I/O	13					
A3PE600L	Single-end I/O					270	
	Differential I/O					135	
A3P1000/M1A3P1000	Single-end I/O		154	97	177	300	
	Differential I/O		35	25	44	74	
A3PE3000L/M1A3PE3000L	Single-end I/O					341	620
	Differential I/O					168	310
AFS600	Single-end I/O				119	172	
	Differential I/O				58	86	
AFS1500	Single-end I/O				119	223	
	Differential I/O				58	109	
A2F060	Analog I/O				16		
	FPGA I/O				66		
	MSS I/O				26		
A2F500	Analog I/O				26	35	
	FPGA I/O				66	128	
	MSS I/O				25	41	

Notes:

1. (G) indicates that the package is RoHS 6/6 compliant/Pb-free.

Automotive-Grade Products

Microsemi offers dedicated automotive-grade devices with various densities, features, footprints, and temperature grades. All devices and packages are AEC-Q100-qualified and tested at extended temperatures. PPAP documentation is available for ProASIC3 devices on request.

Family	Logic Elements	Temperature Range	Maximum User I/Os	Maximum SERDES
IGLOO2 ¹	6K to 86K	Grade 1 (-40 °C to 135 °C) Grade 2 (-40 °C to 125 °C)	Up to 425	4 ¹
SmartFusion2	6K to 86K	Grade 2 (-40 °C to 125 °C)	Up to 425	4
ProASIC3	700K to 11K	Grade 1 (-40 °C to 135 °C) Grade 2 (-40 °C to 115 °C)	Up to 300	Not available

Notes:

1. SERDES is only supported in the IGLOO2 devices with Grade 2 temperature range, not on Grade 1 temperature range.

ProASIC3 Package Options

Features	A3P060	A3P125	A3P250	A3P1000
Pitch (mm)	0.5	1	1	1
Length x width (mm)	16 x 16	13 x 13	17 x 17	23 x 23
Device	I/O	I/O	I/O	I/O
A3P060	71	96		
A3P125	71	97		
A3P250	68/13	97/24		
A3P1000		97/25	177/44	300/74

SmartFusion 2 and IGLOO2 Package Options

Type	VFG256 ¹		VFG400 ¹		FGG484 ¹		FGG676 ¹	
Pitch (mm)	0.8		0.8		1		1	
Length x width (mm)	14 x 14		17 x 17		23 x 23		27 x 27	
Device	I/O	Lanes	I/O	Lanes	I/O	Lanes	I/O	Lanes
M2S005S	161		171		209			
M2S010TS	138	2	195	4	233	4		
M2S025TS	138	2	207	4	267	4		
M2S060TS			207	4	267	4	387	4
M2S090TS					267	4	425	4

Note :

1. All Automotive packages are RoHS compliant and available in lead-free options only.

2. Shading indicates that device packages have vertical migration capability.

Design Tools for Microsemi FPGAs and SoC FPGAs

Libero® SoC

Microsemi's Libero SoC design suite offers high productivity with its comprehensive, easy-to-learn, easy-to-adopt development tools that are used for designing with Microsemi's power-efficient flash-based devices.

The Libero SoC design suite manages the entire design flow from design entry, synthesis, and simulation, through place-and-route, timing, and power analysis, with enhanced integration of the embedded design flow. The suite integrates industry-standard Synopsys Synplify Pro synthesis and Mentor Graphics ModelSim simulation with best-in-class constraints management, debug capabilities, timing analysis, power analysis, secure production programming, and push button-design flow.

The Libero SoC design suite features an intuitive design flow with GUI wizards to guide the design process. Its easy-to-adopt, single-click synthesis-to-programming flow integrates industry-standard third-party tools, and a rich IP library of DirectCores and CompanionCores, and it supports complete reference designs and development kits.

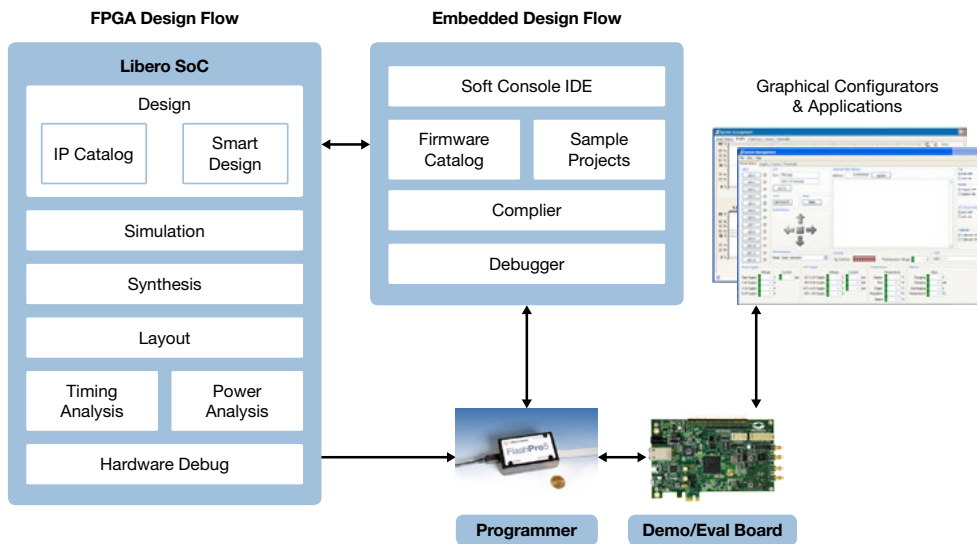

SmartDebug

SmartDebug tool is a new approach to debug the Microsemi FPGAs and SERDES without using an integrated logic analyzer (ILA). SmartDebug utilizes the dedicated and specialized probe points built into the FPGA fabric, which significantly accelerates and simplifies the debug process. It also provides the ability to select different probe points without additional overhead and saves significant recompile time. SmartDebug supports IGLOO2, SmartFusion2, and RTG4 FPGA families only. The enhanced debug features implemented in these FPGAs give access to any logic element and enable designers to check the state of inputs and outputs in real time, without any need to re-design.

- Uses minimal FPGA resources for debug
- Active probes support static and pseudo static signals
- Live probe supports dynamic signals
- Requires no recompilation or re-programming
- Has observability and controllability features
- Allows on-the-fly changing of probe points

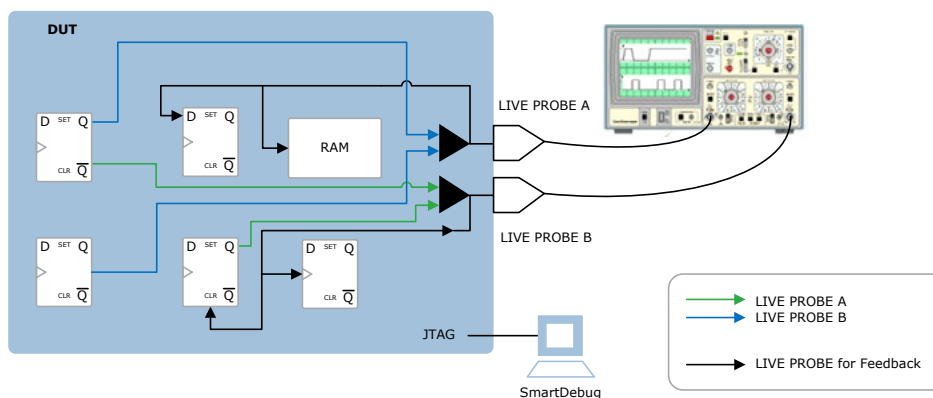

Licensing Information

Libero Device Support

Product Family	Device	Software			License Type			
		Libero IDE	Libero SoC	Libero SoC PolarFire	Eval (Free)	Silver (Free)	Gold	Platinum/ Standalone
PolarFire	MPF100T			x	x	x	x	x
	MPF100, MPF200 (T & TS devices), MPF300 packages on eval boards only			x	x		x	x
	All PolarFire devices			x	x			x
SmartFusion2, IGLOO2	M2S005, M2S010, M2S025 (T devices included) M2GL005, M2GL010, M2GL025 (T devices included)		x		x	x	x	x
	All SmartFusion2 and IGLOO2 devices including S devices		x		x		x	x
SmartFusion, IGLOO, ProASIC3, Fusion	All Devices		x		x	x	x	x
ProASIC and ProASIC ^{PLUS}	All Devices	x					x	x
Accelerator	AX125, AX250, AX500, AX1000	x					x	x
	AX2000	x						x
SX-A, eX, MX	All Devices	x					x	x

License Types

	Evaluation	Silver	Gold	Platinum	Standalone Archive	Standalone (1 yr)
Validity	30 days	1Yr	1Yr	1Yr	Permanent (No Upgrades)	1Yr
DirectCores	Libero IP bundle obfuscated and selected RTL IPs	Libero IP bundle obfuscated and selected RTL IPs	Libero IP bundle obfuscated and selected RTL IPs	RTL for Libero IP bundle cores	RTL for Libero IP bundle cores	Libero IP bundle obfuscated and selected RTL IPs
Simulation	ModelSim ME ProMixed language simulation	ModelSim ME Single language simulation	ModelSim ME Pro Mixed language simulation	ModelSim ME Pro Mixed language simulation	Not applicable	Not applicable
Synthesis	Synplify Pro	Synplify Pro	Synplify Pro	Synplify Pro	Not applicable	Not applicable
Programming	Not Supported	Supported	Supported	Supported	Supported	Supported
Identify	Not Supported	Supported	Supported	Supported	Not Supported	Not Supported

Development Kits

PolarFire Evaluation Kit

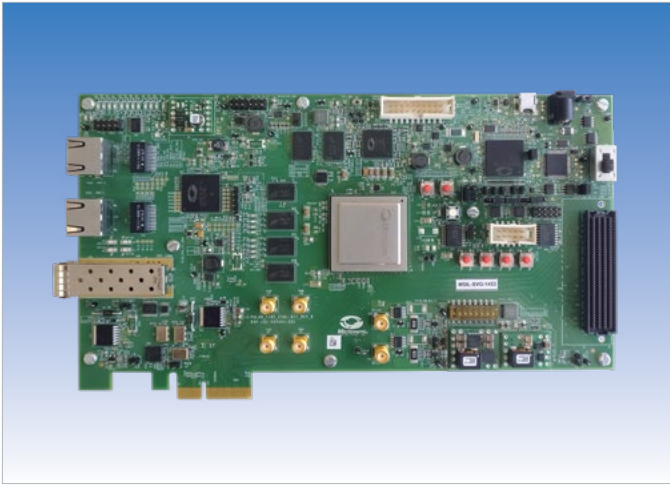

- 4GB 32-bit DDR4, 2GB 16-bit DDR3, and 1Gb SPI Flash Memory
- 2x RJ45 ports with PHY for Ethernet 1588 applications
- Support for SFP+ interface and IOG loopback
- High-speed SerDes interface
- 4x FMC connector (HPC)
- In-silicon temperature monitoring
- On-board 50 MHz system clock

Part Number	Supported Device	Price
MPF300-EVAL-KIT-ES	MPF300TS-1FCG1152EES	\$1495

PolarFire Splash Kit

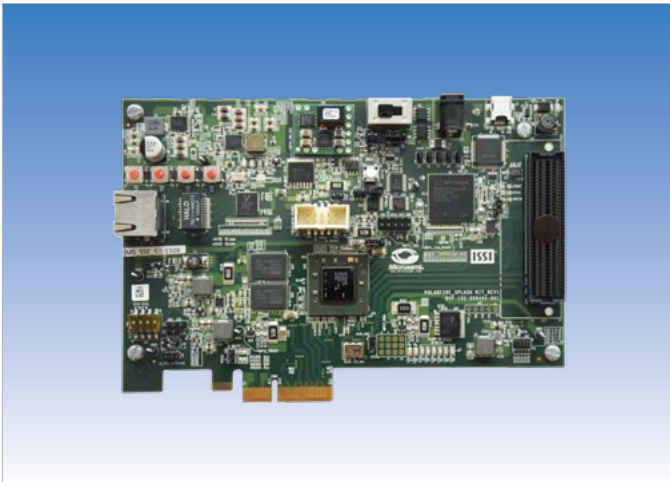

- RJ45 port with PHY for SGMII applications
- FMC connector (LPC)
- Prototype breadboard area
- PCI express (x4) edge connector
- On-board 50 MHz system clock

Part Number	Supported Device	Price
MPF300-SPLASH-KIT-ES	MPF300TS-1FCG484EES	\$699

Development Kits

Arrow PolarFire Everest Kit

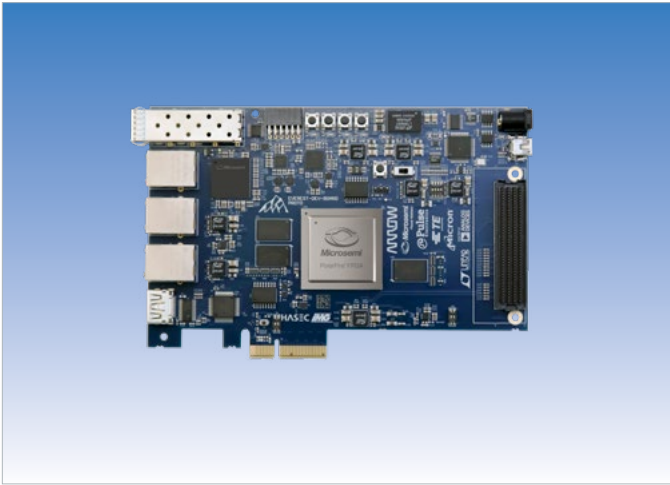

- Triple 1GbE interface
- 1 × 10GbE SFP+ cage
- PCI express (x4) Gen2
- Dual DDR3L (x32 and x16)
- High-speed FMC (HPC) expansion
- HDMI output
- Expansion connectors: PMOD
- Other low-speed interfaces: UART, SPI, and I2C

Part Number	Supported Device	Price
AVMPF300TS-01	MPF300TS-1FCG1152EES	\$499

Future PolarFire Avalanche Board

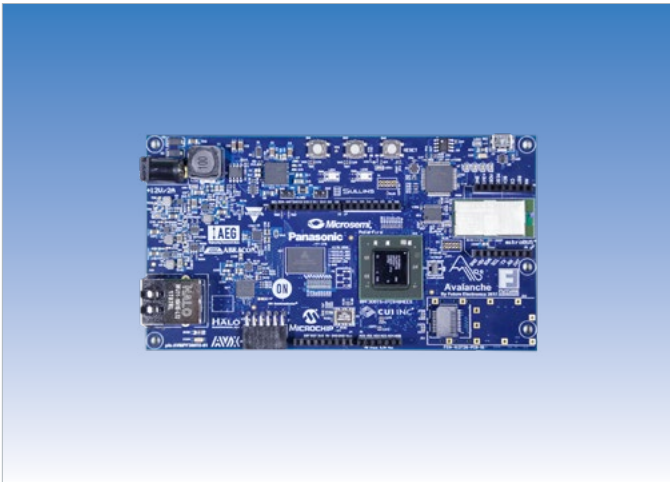

- 1GbE interface with PHY (VSC8531)
- WiFi module
- Expansion connectors: Arduino Shield, MikroBus, PMOD
- DDR3 SDRAM (256Mx16)
- SFP cage
- 64 Mbit SPI Flash
- Other low-speed interfaces: UART and JTAG

Part Number	Supported Device	Price
AVMPF300TS-01	MPF300TS-FCG484EES	\$179.95

Development Kits

SmartFusion2 Starter Kit

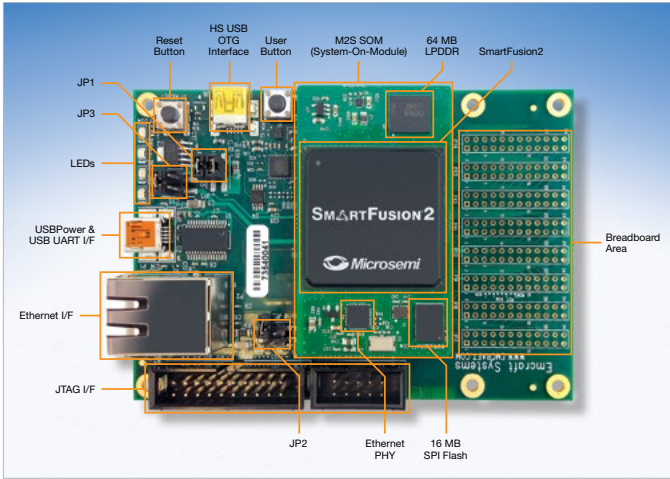

- Cost-efficient development platform for SmartFusion2 SoC FPGA
- Supports industry-standard interfaces, including Ethernet, USB, SPI, I²C, and UART
- Preloaded with uClinux image to support Linux-based development environments
- Comes with FlashPro4 programmer, USB cables, and USB WiFi module
- Board features
 - 50K LE or 10K LE SmartFusion2 device
 - JTAG interface for programming and debug
 - 10/100 Ethernet
 - USB 2.0 On-The-Go
 - 64 MB LPDDR, 16 MB SPI flash memory
 - Four LEDs and two push-button switches

Part Number	Supported Device	Price
SF2-STARTER-KIT	M2S050-FGG484	\$299
SF2-484-STARTER-KIT	M2S010-FGG484	\$299
SF2060-STARTER-KIT	M2S060-FGG484	\$299

SmartFusion2 Advanced Development Kit

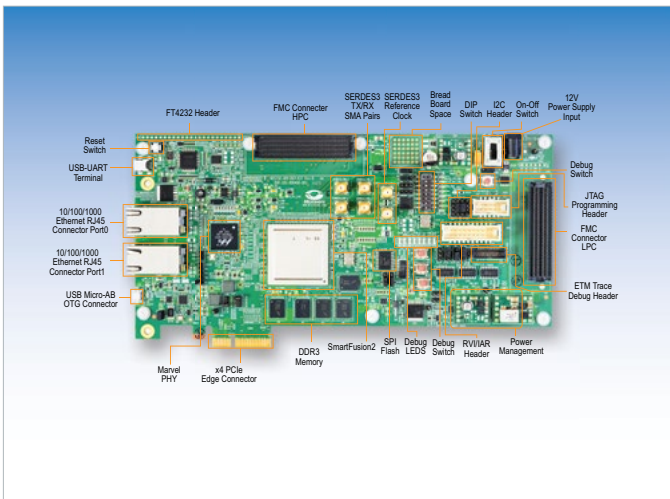

- Full featured kit to develop applications using SmartFusion2 SoC FPGAs
- Enables power measurement
- Two FMC connectors with HPC/LPC pinout for expansion
- Various communication interfaces, switches, and LEDs for prototyping
- Kit comes with free 1-year Gold Libero SoC license
- Board features
 - 150K LE SmartFusion2 device
 - DDR3 SDRAM, SPI flash
 - Current measurement test points
 - A pair of SMA connectors, two FMC connectors, PCIe x4 edge connector
 - 2xRJ45 interface for 10/100/1000 Ethernet USB micro-AB connector
 - FTDI programmer interface to program the external SPI flash
 - JTAG/SPI programming interface, RVI header for application programming, and debug
 - Quad 2:1 MUX/DEMUX high-bandwidth bus switch
 - Dual in-line package (DIP) switches for user application
 - Push-button switches and LEDs for demo purposes

Part Number	Supported Device	Price
M2S150-ADV-DEV-KIT	M2S150TS-1FCG1152	\$999

SmartFusion2 Security Evaluation Kit

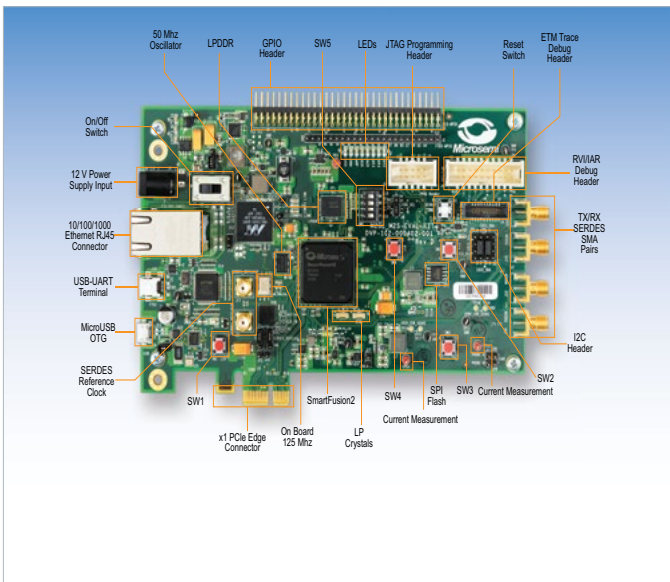

- Evaluate the data security features of SmartFusion2 SoC FPGAs
- Develop and test PCI Express Gen2 x1 lane designs
- Test the signal quality of the FPGA transceiver using full-duplex SERDES SMA pairs
- Measure the low power consumption of the SmartFusion2 SoC FPGA
- Quickly create a working PCIe link with the included PCIe control plane demo
- Kit includes free 1-year Gold Libero SoC license
- Board features
 - 90 K LE SmartFusion2 device
 - 64 Mbit SPI flash memory
 - 512 MB LPDDR
 - PCI Express Gen2 x1 interface
 - Four SMA connector for testing of full-duplex SERDES channel
 - RJ45 interface for 10/100/1000 Ethernet
 - JTAG/SPI programming interface
 - Headers for I²C, SPI, GPIOs
 - Push-button switches and LEDs for demo purposes
 - Current Measurement Test Points

Part Number	Supported Device	Price
M2S090TS-EVAL-KIT	M2S090TS-FGG484	\$399

Development Kits

Digikey SmartFusion2 Maker Board

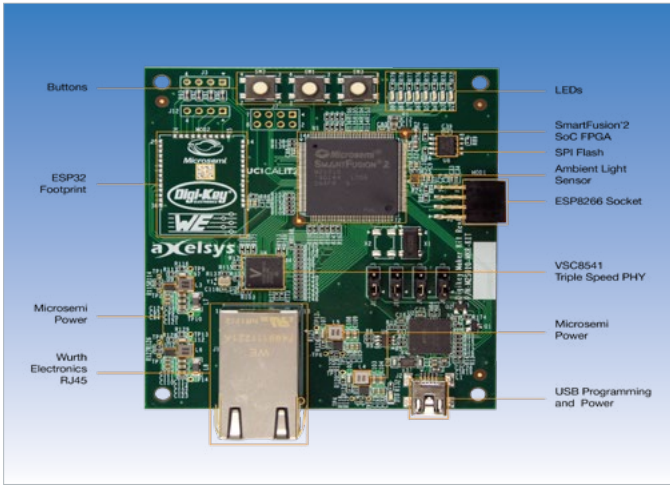

Devices: M2S010-MKR-KIT

- The SmartFusion2 M2S010 SoC FPGA
- Ambient Light Sensor
- USB Integrated FlashPro5 programming hardware
- 16Mbit SPI Flash
- The 10/100/1000BASE-T VSC8541 PHY
- USB port for UART communications
- 50 MHz clock source
- Würth Electronics RJ45 7499111221A

Part Number	Supported Device	Price
M2S010-MKR-KIT	M2S010-TQG144	\$33.75 available from Digi-Key

IGLOO2 Evaluation Kit

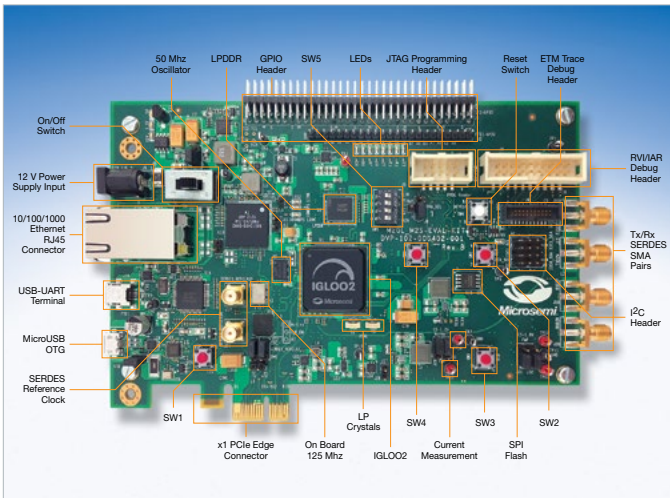

- Gives designers access to IGLOO2 FPGAs that offer leadership in I/O density, security, reliability, and low-power for mainstream applications
- Board features
 - IGLOO2 FPGA in the FGG484 package (M2GL010T-1FGG484)
 - JTAG/SPI programming interface
 - Gigabit Ethernet PHY and RJ45 connector
 - USB 2.0 OTG interface connector
 - 1 GB LPDDR, 64 MB SPI flash
 - Headers for I²C, UART, SPI, GPIOs
 - x1 Gen2 PCIe edge connector
 - Tx/Rx/Clk SMP pairs
- Supports industry-standard interfaces including Gigabit Ethernet, USB 2.0 OTG, SPI, I²C, and UART
- Comes preloaded with a PCIe control plane demo
- Can be powered by a 12 V power supply or the PCIe connector, and includes a FlashPro4 programmer

Part Number	Supported Device	Price
M2GL-EVAL-KIT	M2GL010T-1FGG484	\$399

Future IGLOO2 RISC-V Creative Development Board

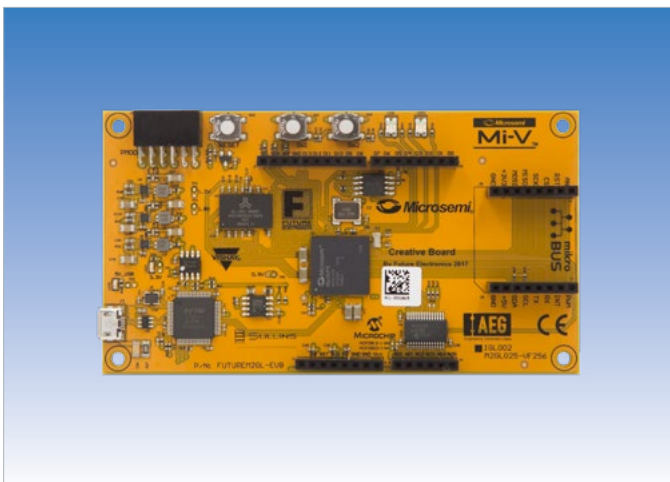

Future's IGLOO2 RISC-V Creative Development Board includes

- Microsemi IGLOO2 FPGA
- MikroBUS™-compatible expansion headers
- Microsemi LX7167 DC/DC
- PMOD™-compatible expansion connector
- Alliance 32M x 16-bit DDR2 synchronous DRAM (SDRAM)
- User buttons and LED
- Microchip 64 Mbit serial flash
- 25K (LE) FPGA, offering the lowest cost-of-entry for both software and hardware engineers who want to evaluate and implement their own unique designs
- Microchip six synchronous sampling 16/24-bit resolution Delta-Sigma A/D converters
- Microsemi's LX series power devices
- On-board FTDI USB-JTAG adaptor
- Arduino™-compatible expansion headers

Part Number	Supported Device	Price
FUTUREM2GL-EVB	M2GL025	\$99.95 (available from Future Electronics)

Imaging and Video Solution

Microsemi provides a complete, easy-to-use development environment for designing low-power and secure video processing applications. The solution includes an IP suite with modular IP, and FPGA mezzanine card (FMC) for the SmartFusion2 advanced development kit, and a software GUI. The IP suite currently supports SmartFusion2 SoC FPGA and IGLOO2 FPGA product families. Support for the PolarFire FPGA product family is currently in development.

Key Features

- Modular IP suite
- Support for MIPI CSI-2 or parallel sensor interfaces
- Display interface for 7:1 LVDS or HDMI
- The most secure FPGA to protect your design IP
- Easy-to-use software GUI for real-time audio and video configuration



MIPI CSI-2 or Parallel Sensor FMC daughter card options (AR330 Image Sensor Board included)

Solution Overview

Hardware

- Imaging and video FMC daughter card with camera module options
- SmartFusion2 advanced development kit or PolarFire Evaluation Kit (Sold separately and includes a one-year Gold license of Libero SoC software)

IP Suite

The following imaging and video processing IP cores are included in Libero® SoC, a comprehensive software toolset for designing with Microsemi FPGAs and SoC FPGAs.

The IP suite supports SmartFusion2, IGLOO2 and RTG4 product families, with PolarFire support currently in development

- Sensor interface—Parallel, MIPI CSI-2
- Bayer conversion
- Color-space conversion
- Image-edge detection
- Video scaler
- Alpha blending and overlay
- Image sharpening filter
- Image de-noising filter (under development)
- Display control (LVDS and parallel RGB-HDMI)
- Source code in Verilog (requires licensing fee)

Name	Version
Processors	
SC/Tamper	
Solutions-MotorControl	
Solutions-Video	
Alpha Blending	1.0.1
Bayer Interpolation	1.0.1
Display Controller	1.0.1
Image Edge Detection	1.0.1
Image Enhancement	1.0.1
Image Sharpen	1.0.1
LVDS 7:1 Receiver	1.0.1
LVDS 7:1 Transmitter	1.0.1
MIPI CSI2 Rx/Decoder	2.0.0
RGB To YCbCr	1.0.1
SF2 DDR Memory Arbitr	1.0.1
Scaler	1.0.1
Test Pattern Generator	1.0.1
YCbCr to RGB	1.0.1
Solutions-WiredComms	
Tamper	

Software GUI

Enables video and audio configurations

- GUI communicates with IP blocks through SmartFusion2 ARM® Cortex®-M3 processor
- Supports the following demos:
 - Camera sensor to display
 - Image edge detection

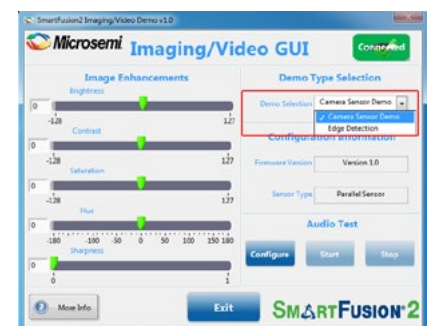

Motor Control Solution

Build Safe and Reliable Deterministic Motor Control Applications

Microsemi's Deterministic Motor Control Solution is specially designed to meet the challenging requirements of performance, reliability, and safety in an easy-to-use environment. The solution is compliant with industry coding standards for developing safe and reliable software for embedded applications. Microsemi offers a modular intellectual property (IP) portfolio, tools, reference designs, kits, and software to control motors such as permanent-magnet synchronous motor (PMSM)/brushless DC (BLDC), and stepper motors.



Ordering Code	Supported Device	Price
SF2-MC-STARTER-KIT	M2S010-FG484	\$899

Field Oriented Control-System Diagram

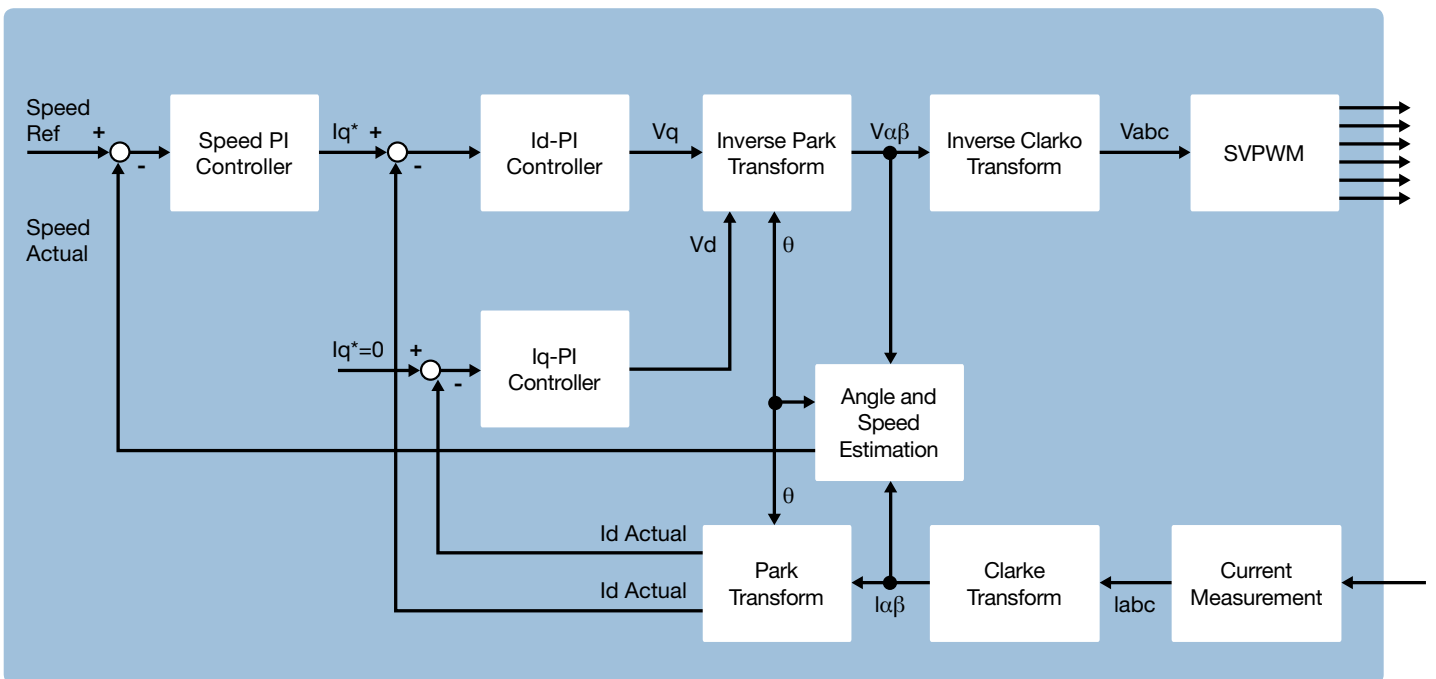

Reference Design Features

- Dual-axis deterministic motor control on a single system-on-chip (SoC) field programmable gate array (FPGA)
- Efficient, reliable, and safe drive/motor control with product longevity
- Compact solution saves board space and reduces product size
- Motor performance is tested for speeds exceeding 100,000 RPM for sensorless field-oriented control (FOC)
- Low latency of 1 μ s for FOC loop from ADC measurement to PWM enables switching frequencies up to 500 kHz
- Design flexibility with modular IP suite
- Advanced safety features, such as automatic motor restart and overcurrent protection
- SoC integration of system functions lowers total cost of ownership (TCO)

Microsemi Intellectual Property

Microsemi enhances your design productivity by providing an extensive suite of proven and optimized IP Cores for use with Microsemi FPGAs and SoC FPGA that covers key markets and applications. IPs are organized as either Microsemi-developed DirectCores™ or third-party-developed CompanionCores.™

IP cores are searchable at: <http://soc.microsemi.com/products/ip/search/default.aspx>

Microsemi DirectCore

Microsemi develops and supports DirectCore IP cores for applications with the widest possible interest. Most DirectCores are available for free within our Libero tool suite. Common communications interfaces, peripherals, and processing elements are all available as DirectCores. The following table shows Microsemi's DirectCore offerings.

Functionality	DirectCore Examples
Connectivity	UART, 16550, 429, PCI, JESD204B
DSP	CIC, FFT, FIR, CORDIC, RS
Memory Controller	FIFO, DDR, QDR, SDR, MemCtrl, MMC
Processor	Cortex-M3, 8051, 8051s, ARM7TDMI
Ethernet	MII, RGMII, GMII, SGMII
Security	DES, 3DES, AES, SHA
Error Correction	EDAC, RC

Microsemi CompanionCore

Microsemi CompanionCore Partners use their detailed system knowledge of common applications to craft optimized solutions targeted for Microsemi FPGAs and SoC FPGA. CompanionCores are available for purchase from our partners and are easily integrated into your design using our Libero tool suite. The following table shows examples of CompanionCore Partners offerings.

Functionality	CompanionCore Examples
Connectivity	CAN, CANFD, PCIE, VME
DSP	FFT, JPEG, RS, DVBMOD
Memory Controller	SDRAMDDR, Flash, SD
Processor	80188, 80186, LEON3, 6809
Security	MD5, ARC4, RNG, ZUC, AES, SHA, 802.1ae (MACSec)
Error Correction	RS

Microsemi IP Available for Use with Libero

Please contact your local Microsemi sales representative for information on price and licensing, as certain Microsemi IPs may require a separate license. CompanionCores supported by Microsemi are available at:

<http://www.microsemi.com/products/fpga-soc/design-resources/ip-cores#companioncores>.

Product Name	Obfuscated RTL Available for Purchase	RTL Source Available for Purchase
CoreFFT	Not available	RTL source
Core1553BRM	Obfuscated RTL	RTL source
Core1553BRT, Core1553BRT_APB	Obfuscated RTL	RTL source
Core429, Core429_APB	Obfuscated RTL	RTL source
CorePCIF, CorePCIF_AHB	Obfuscated RTL	RTL source
CoreTSE, CoreTSE_AHB	Obfuscated RTL	RTL source
CoreCIC	Not available	RTL source

Notes:

1. Additional cores and configurations can be found on the website and in core handbooks.

PolarFire IP

Microsemi enhances your design productivity by providing an extensive suite of proven and optimized IP cores for use with Microsemi FPGAs. Our extensive suite of IP cores covers all key markets and applications. Our cores are organized as either Microsemi-developed DirectCores or third-party-developed CompanionCores. Most DirectCores are available for free within our Libero tool suite and include common communications interfaces, peripherals, and processing elements.

PolarFire IP (Available Now)

- AXI4Interconnect
- Core3DES
- CoreABC
- CoreAHLite
- CoreAHL2AHL Bridge
- CoreAHLTOAXI
- CoreAHLSRAM
- CoreAHLtoAPB3
- CoreAPB3
- CoreAXI4DMA Controller
- CoreAXI4SRAM
- CoreAXItoAHL
- CoreCORDIC
- CoreDDRMemCtrlr
- CoreDDS (NCO)
- CoreDES
- CoreFFT
- CoreFIFO
- CoreFIR
- CoreGPIO
- CoreI2C
- CoreJESD204BRX
- CoreJESD204BTX
- CoreMDIO_APB
- CorePCS
- CorePWM
- CoreRSDEC
- CoreRSENC
- CoreRISCV
- CoreRMII
- CoreSPI
- CoreSysServices_PF
- CoreUART
- CoreUART_APB
- CoreLSM
- CPRI (PHY only)
- CRYPTO
- DDR3
- DPSRAM
- DRI
- PCIe End Point
- TAMPER
- TPSRAM
- UPROM
- URAM
- 1GbE IO-CDR
- Core10GMAC 10GBASE-R
- Core429
- CoreSGMII
- CoreTSE, CoreTSE_AHB
- DDR4
- CoreRGMII

PolarFire IP (Soon to Be Released)

- CorePCIF/CorePCIF_AHB
- HD-SDI Tx/HD-SDI Rx (3G)
- CoreXAUI
- CoreRXAUI
- Core1553BRM
- Core1553BRT/Core1553BRT_APB
- PCIe Root Port
- CoreQDR
- 10GBASE-KR
- LPDDR3
- 10G NGPON
- CSI-2 Rx
- QSGMII
- 12G SDI
- CoreCIC
- CoreQSPI
- CSI-2 Tx
- CoreSquareRoot
- Fixed Point to Floating

Microsemi is continually adding new products to its industry-leading portfolio.

For the most recent updates to our product line and for detailed information and specifications, please call, email, or visit our website.

Toll-free: 800-713-4113

sales.support@microsemi.com

www.microsemi.com



Microsemi Corporate Headquarters
One Enterprise, Aliso Viejo, CA 92656 USA
Within the USA: +1 (800) 713-4113
Outside the USA: +1 (949) 380-6100
Fax: +1 (949) 215-4996
Email: sales.support@microsemi.com
www.microsemi.com

©2018 Microsemi Corporation. All rights reserved.
Microsemi and the Microsemi logo are registered trademarks of Microsemi Corporation. All other trademarks and service marks are the property of their respective owners.

Microsemi Corporation (Nasdaq: MSCC) offers a comprehensive portfolio of semiconductor and system solutions for aerospace & defense, communications, data center and industrial markets. Products include high-performance and radiation-hardened analog mixed-signal integrated circuits, FPGAs, SoCs and ASICs; power management products; timing and synchronization devices and precise time solutions, setting the world's standard for time; voice processing devices; RF solutions; discrete components; enterprise storage and communication solutions, security technologies and scalable anti-tamper products; Ethernet solutions; Power-over-Ethernet ICs and midspans; as well as custom design capabilities and services. Microsemi is headquartered in Aliso Viejo, California and has approximately 4,800 employees globally. Learn more at www.microsemi.com.

Microsemi makes no warranty, representation, or guarantee regarding the information contained herein or the suitability of its products and services for any particular purpose, nor does Microsemi assume any liability whatsoever arising out of the application or use of any product or circuit. The products sold hereunder and any other products sold by Microsemi have been subject to limited testing and should not be used in conjunction with mission-critical equipment or applications. Any performance specifications are believed to be reliable but are not verified, and Buyer must conduct and complete all performance and other testing of the products, alone and together with, or installed in, any end-products. Buyer shall not rely on any data and performance specifications or parameters provided by Microsemi. It is the Buyer's responsibility to independently determine suitability of any products and to test and verify the same. The information provided by Microsemi hereunder is provided "as is, where is" and with all faults, and the entire risk associated with such information is entirely with the Buyer. Microsemi does not grant, explicitly or implicitly, to any party any patent rights, licenses, or any other IP rights, whether with regard to such information itself or anything described by such information. Information provided in this document is proprietary to Microsemi, and Microsemi reserves the right to make any changes to the information in this document or to any products and services at any time without notice.

Looking for pricing, stock, or lifecycle information?

Click below to explore more details on WIN SOURCE:

- ⊖ [View A3P1000-PQG208 on WIN SOURCE](#)
- ⊖ [Microsemi Corporation](#) Information

Optimize Your Supply Chain with WIN SOURCE Solutions

- ✓ Global Sourcing Solution
- ✓ Obsolete Management
- ✓ Cost Control Management
- ✓ Shortage Management
- ✓ Alternative Solution
- ✓ Excess Inventory Management