



**THE DATASHEET OF
UCD2A331MNQ1MS**



ALUMINUM ELECTROLYTIC CAPACITORS

UCD Chip Type, Low Impedance



- Chip type, low impedance temperature range up to +105°C.
- Designed for surface mounting on high density PC board.
- Applicable to automatic mounting machine fed with carrier tape.
- Compliant to the RoHS directive (2011/65/EU).
- AEC-Q200 compliant. Please contact us for details.



Specifications

Item	Performance Characteristics										
Category Temperature Range	- 55 to +105°C										
Rated Voltage Range	6.3 to 100V										
Rated Capacitance Range	1 to 3300μF										
Capacitance Tolerance	±20% at 120Hz, 20°C										
Leakage Current	After 2 minutes' application of rated voltage at 20°C, leakage current is not more than 0.01 CV or 3 (μA), whichever is greater.										
Tangent of loss angle (tan δ)	Measurement frequency : 120Hz at 20°C										
	Rated voltage (V)	6.3	10	16	25	35	50	63	80	100	
	tan δ (MAX.)	0.26	0.19	0.16	0.14	0.12	0.10	0.08	0.08	0.07	
For capacitance of more than 1000μF, add 0.02 for every increase of 1000μF.											
Stability at Low Temperature	Measurement frequency : 120Hz										
	Rated voltage (V)	6.3	10	16	25	35	50	63	80	100	
	Impedance ratio ZT / Z20 (MAX.)	Z-25°C / Z+20°C	2	2	2	2	2	2	2	2	2
		Z-40°C / Z+20°C	3	3	3	3	3	3	3	3	3
Z-55°C / Z+20°C		4	4	4	3	3	3	3	3	3	
Endurance	The specifications listed at right shall be met when the capacitors are restored to 20°C after the rated voltage is applied for 5000 hours (2000 hours for L < 10 mm: 50V or less, and for L ≤ 10mm: 63V or more) at 105°C.										
	Capacitance Change	Within ± 30% of the initial capacitance value									
	tan δ	200% or less than the initial specified value 300% or less than the initial specified value for 63V or more									
Shelf Life	After storing the capacitors under no load at 105°C for 1000 hours and then performing voltage treatment based on JIS C 5101-4 clause 4.1 at 20°C, they shall meet the specified values for the endurance characteristics listed above.										
	Capacitance Change	Within ± 10% of the initial capacitance value									
	tan δ	Less than or equal to the initial specified value									
Resistance to soldering heat	The capacitors are kept on a hot plate for 30 seconds, which is maintained at 250°C. The capacitors shall meet the characteristic requirements listed at right when they are removed from the plate and restored to 20°C.										
	Capacitance Change	Within ± 10% of the initial capacitance value									
	Leakage current	Less than or equal to the initial specified value									
Marking	Black print on the case top.										

Chip Type

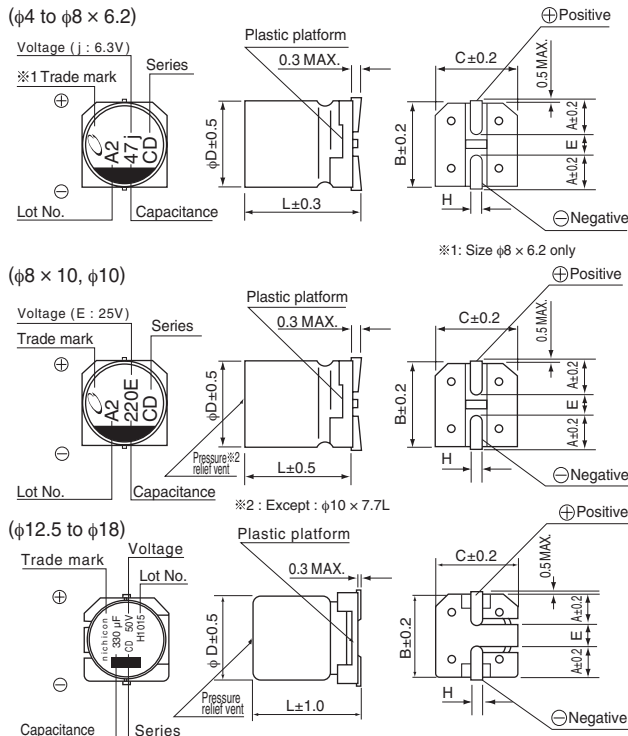

Type numbering system (Example : 16V 100μF)

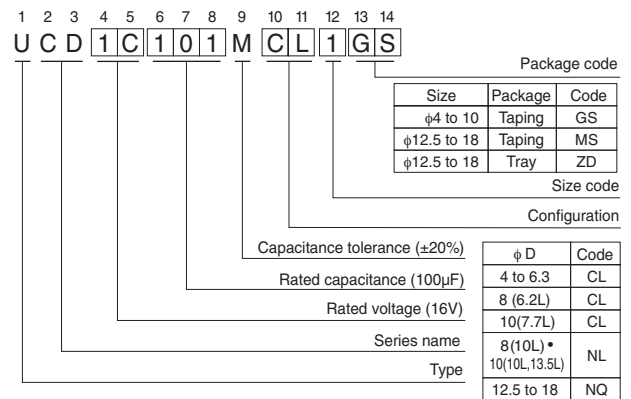

φD × L	4 × 5.8	5 × 5.8	6.3 × 5.8	6.3 × 7.7	8 × 6.2	8 × 10	10 × 7.7	10 × 10	(mm)
A	1.8	2.1	2.4	2.4	3.3	2.9	3.2	3.2	
B	4.3	5.3	6.6	6.6	8.3	8.3	10.3	10.3	
C	4.3	5.3	6.6	6.6	8.3	8.3	10.3	10.3	
E	1.0	1.3	2.2	2.2	2.3	3.1	4.5	4.5	
L	5.8	5.8	5.8	7.7	6.2	10	7.7	10	
H	0.5 to 0.8	0.5 to 0.8	0.5 to 0.8	0.5 to 0.8	0.5 to 0.8	0.8 to 1.1	0.8 to 1.1	0.8 to 1.1	

φD × L	10 × 13.5	12.5 × 13.5	16 × 16.5	18 × 16.5
A	3.2	4.8	5.4	6.4
B	10.3	13.6	17.1	19.1
C	10.3	13.6	17.1	19.1
E	4.5	4.0	6.3	6.3
L	13.5	13.5	16.5	16.5
H	0.8 to 1.1	1.0 to 1.4	1.0 to 1.4	1.0 to 1.4

Voltage									
V	6.3	10	16	25	35	50	63	80	100
Code	j	A	C	E	V	H	J	K	2A

※φ8 × 10L, φ10 × 10L, φ12.5 × 13.5L, φ16 × 16.5L, φ18 × 16.5L : The vibration structure-resistant product is also available upon request, please ask for details.

• Dimension table in next page.





Looking for pricing, stock, or lifecycle information?

Click below to explore more details on WIN SOURCE:

 [View UCD2A331MNQ1MS on WIN SOURCE](#)

 [Nichicon Information](#)

Optimize Your Supply Chain with WIN SOURCE Solutions

-  Global Sourcing Solution
-  Obsolete Management
-  Cost Control Management
-  Shortage Management
-  Alternative Solution
-  Excess Inventory Management