

Features

- Phase Controlled Thyristor Ignition
- Triggering with Time Delay
- Repetition Time Delay
- Supply Current ≤ 2 mA
- Mains Supply via Resistor

Applications

- Electric Stapler Devices

Description

The monolithic integrated bipolar circuit, U490B, is a one-shot power control circuit, designed to control the thyristor which is mainly used in electric stapler devices. The IC is preferred to realize a one-shot phase control, where any phase angle, thus any intensity of the load voltage is adjustable. After successful triggering and the following delay time, an ignition pulse at the output is released. Further triggering is only possible after the delay time elapses.

Figure 1. Block Diagram

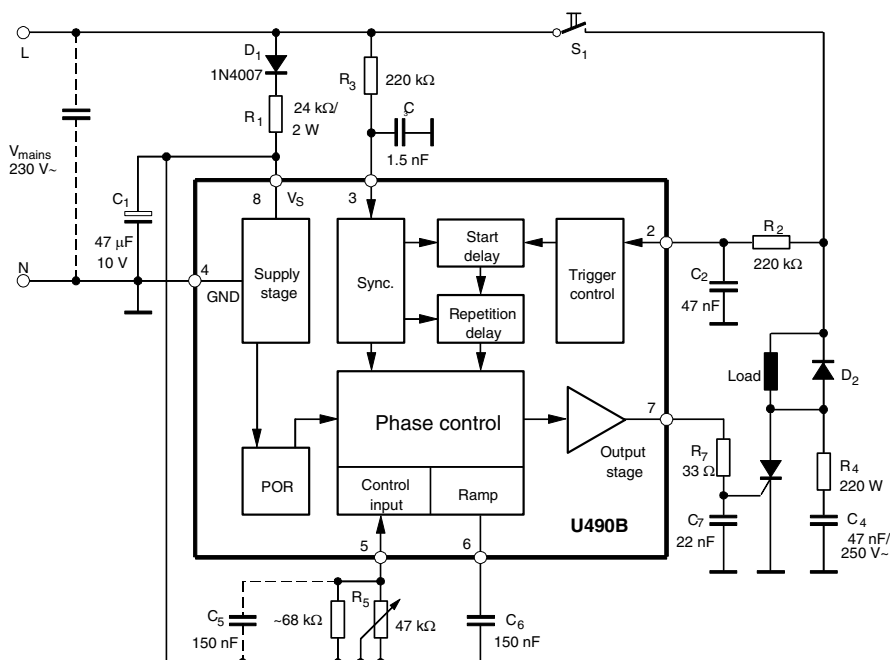

One-shot Phase Control IC

U490B



Pin Configuration

Figure 2. Pinning DIP8/SO8

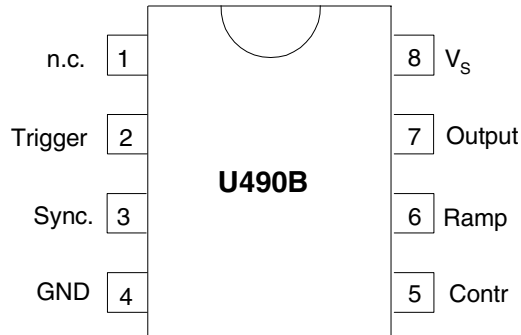

Pin Description

Pin	Symbol	Function
1	n.c.	Not connected
2	Trigger	Triggering
3	Sync.	Synchronization
4	GND	Ground
5	Contr	Control input
6	Ramp	Ramp
7	Output	Output
8	V _S	Supply voltage

Supply, Pin 8

The internal voltage limiter enables a simple supply from the mains via series resistor R_1 . The supply voltage between pin 8 (V_S) and ground (pin 4) builds up via R_1 and is smoothed by the capacitor C_1 .

The series resistor R_1 can be calculated as follows:

$$R_{1\max} \approx 0.85 \times \frac{V_{\text{mains}} - V_{S\max}}{2 \times I_{\text{tot}}} \quad \text{where}$$

V_{mains} Mains supply voltage

$V_{S\max}$ Maximum supply voltage

I_{tot} $I_{S\max} + I_X$

$I_{S\max}$ Maximum current consumption of the IC

I_X Current consumption of the external components

**Phase Control,
Pins 3, 5 and 6**

The circuit is synchronized with mains supply through pin 3. As long as the switch S_1 is open, the circuit is in wait state, i.e., the capacitor C_6 (150 nF) is discharged and is kept in this state (High level). When the switch S_1 is closed, there is a current flow in pin 2 which is evaluated by the circuit. If this current flows after the delay time elapses, the phase control is released. The capacitor C_6 is then charged with $I_6 + 100 \mu\text{A}$ towards ground. At the same time, a current of $\approx 100 \mu\text{A}$ flows into pin 5, which results in a voltage drop across resistor R_5 . The control voltage V_5 is then 1.5 V lower internally.

The output stage is released when the ramp voltage V_6 is equal to $(V_5 - 1.5 \text{ V})$. When the voltage difference is $\approx 150 \text{ mV}$, it is again turned-off.

The result is an output pulse, whose phase shift to the zero crossing of the mains voltage is determined by the resistor R_5 at the control input pin 5 (see Figure 3). The capacitor C_6 is charged to a value of $\approx 1.5 \text{ V}$. This value is kept until the switch S_1 opens again and the repetition delay time has elapsed.

The circuit is released when four periods of the line voltage have expired after build-up of the operating voltage, before the switch S_1 is closed.

Figure 3. Signal Characteristics

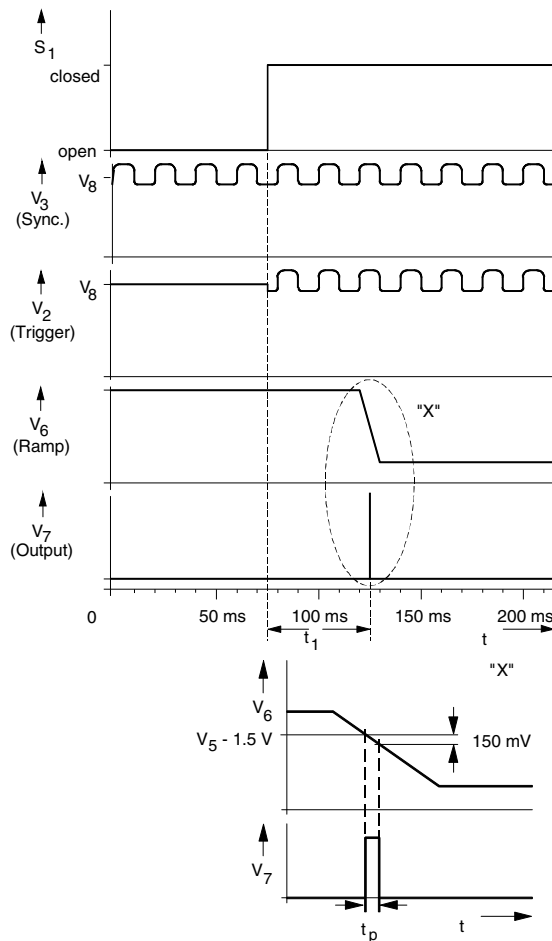

Absolute Maximum Ratings

Stresses beyond those listed under “Absolute Maximum Ratings” may cause permanent damage to the device. This is a stress rating only and functional operation of the device at these or any other conditions beyond those indicated in the operational sections of this specification is not implied. Exposure to absolute maximum rating conditions for extended periods may affect device reliability.

Reference point pin 4 (GND), unless otherwise specified

Parameters	Symbol	Value	Unit
Supply current, pin 8 $t \leq 10 \mu\text{s}$	I_S	30	mA
	i_s	150	mA
Output stage			
Input voltage, pin 7	V_I	-0.5 to V_S	V
Input current, pins 2 and 3 $t \leq 1 \text{ ms}$	$\pm I_I$	5	mA
	$\pm I_I$	30	mA
Input voltage, pins 5 and 6	V_I	0 to V_8	V
Junction temperature	T_J	+125	°C
Ambient temperature	T_{amb}	-10 to +100	°C
Storage temperature range	T_{stg}	-40 to +125	°C

Thermal Resistance

Parameters	Symbol	Value	Unit
Junction ambient DIP8 SO8 on p.c. SO8 on ceramic	R_{thJA}	110	K/W
	R_{thJA}	220	K/W
	R_{thJA}	140	K/W

Electrical Characteristics

$V_S = 7 \text{ V}$, $T_{\text{amb}} = 25^\circ\text{C}$, reference point pin 4 (GND), unless otherwise specified

Parameters	Test Conditions/ Pins	Symbol	Min.	Typ.	Max.	Unit
Supply voltage limitation	$I_S = 3 \text{ mA}$ $I_S = 30 \text{ mA}$ Pin 8	V_S	7.2	8.2	9.2	V
		V_S	7.4	8.4	9.4	V
Current consumption	$V_S = 7 \text{ V}$ Pin 8	I_S			2	mA
Voltage Monitoring						
Switch-on threshold	Pin 8	V_{Son}		5		V
Switch-off threshold		V_{Soff}		3		V
Synchronization						
Voltage limitation	$I_3 = +1 \text{ mA}$ $I_3 = -1 \text{ mA}$ Pin 3 – 8	V_{lim}		1.5		V
		$-V_{\text{lim}}$		0.75		V
Switch-on threshold	Pin 3	I_{Ton}		120		μA
Switch-off threshold		I_{Toff}		35		μA
Trigger Input						
Voltage limitation	$I_2 = +1 \text{ mA}$ $I_2 = -1 \text{ mA}$ Pin 2 – 8	V_{lim}		1.5		V
		$-V_{\text{lim}}$		0.75		V
Switch-on threshold	Pin 2	I_{Ton}		120		μA
Switch-off threshold		I_{Toff}		35		μA
Start delay time	$f_{\text{mains}} = 50 \text{ Hz}$ Pin 2–7	t_1	40		60	ms
Repetition delay time		t_2	60		80	ms

Electrical Characteristics (Continued)

$V_S = 7\text{ V}$, $T_{amb} = 25^\circ\text{C}$, reference point pin 4 (GND), unless otherwise specified

Parameters	Test Conditions/ Pins	Symbol	Min.	Typ.	Max.	Unit
Phase Control						
Control input: Input voltage range Input current	Pin 5 $2\text{ V} \leq V_5 \leq V_8$	V_I I_I	2 50	90	V_S 130	V μA
Ramp						
Charge current Discharge current	$2\text{ V} \leq V_6 \leq V_8 - 0.5\text{ V}$ $V_5 = 4\text{ V}$	I_{ch} $-I_{dis}$	50 2	90	130	μA mA
Phase Shift	$C_6 = 150\text{ nF}$, $V_5 = 2\text{ V}$ $V_5 = V_8$, Pin 7-5	t_{dmax} t_{dmin}		7 600		ms μs
Output Stage, $V_7 + 0\text{ V}$, Pin 7						
Output reverse current Output current	Status OFF Status ON	$\pm I_o(r)$ $-I_o$			10	μA mA
Pulse width	$C_6 = 150\text{ nF}$ (see Figure 3 on page 3)	t_p	100	200	300	μs

Ordering Information

Extended Type Number	Package	Remarks
U490B-x	DIP8	Tube
U490B-xFP	SO8	Tube
U490B-xFPG3	SO8	Taped and reeled

Package Information

Package SO8

Dimensions in mm

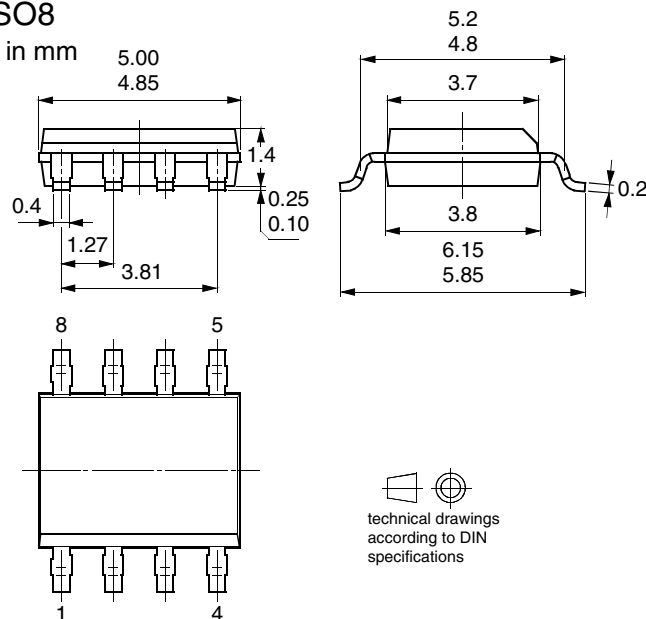

Package: DIP 8
 Dimensions in mm

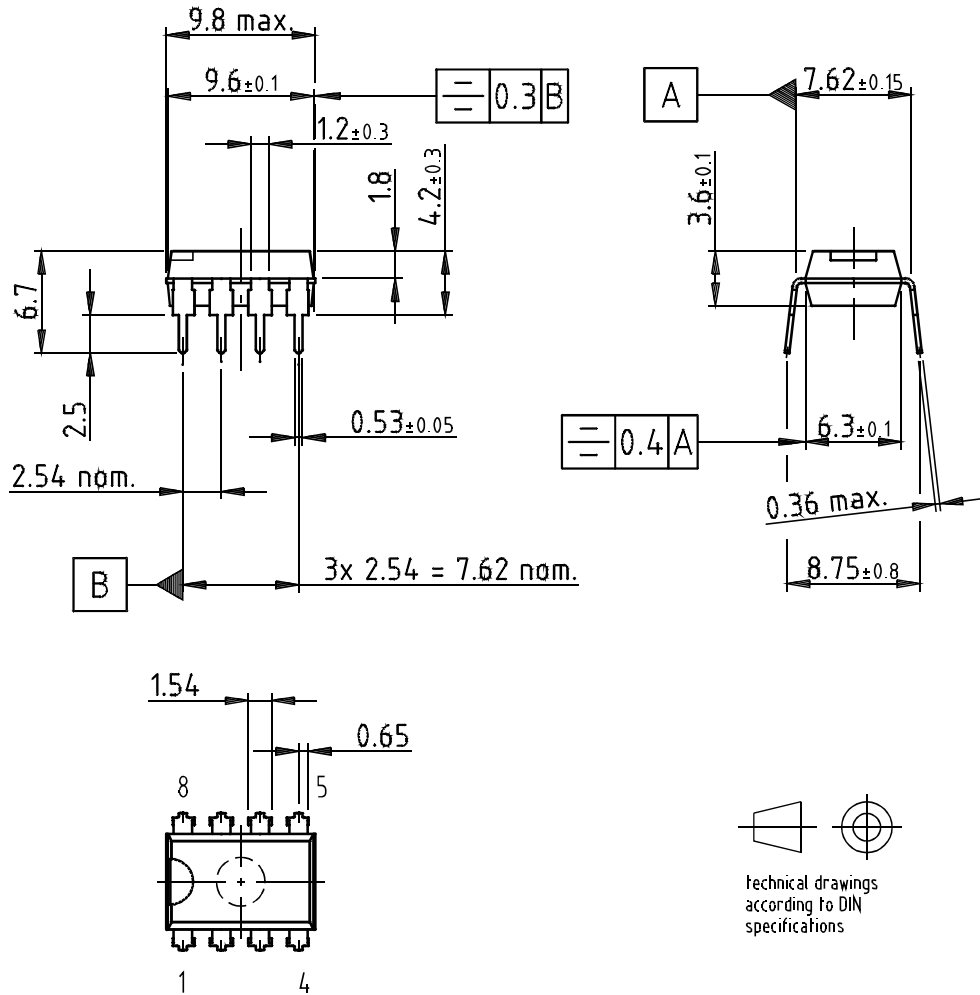

Drawing-No.: 6.543-5040.01-4
 Issue: 1; 16.01.02



Atmel Corporation

2325 Orchard Parkway
San Jose, CA 95131, USA
Tel: 1(408) 441-0311
Fax: 1(408) 487-2600

Regional Headquarters

Europe

Atmel Sarl
Route des Arsenaux 41
Case Postale 80
CH-1705 Fribourg
Switzerland
Tel: (41) 26-426-5555
Fax: (41) 26-426-5500

Asia

Room 1219
Chinachem Golden Plaza
77 Mody Road Tsimshatsui
East Kowloon
Hong Kong
Tel: (852) 2721-9778
Fax: (852) 2722-1369

Japan

9F, Tonetsu Shinkawa Bldg.
1-24-8 Shinkawa
Chuo-ku, Tokyo 104-0033
Japan
Tel: (81) 3-3523-3551
Fax: (81) 3-3523-7581

Atmel Operations

Memory

2325 Orchard Parkway
San Jose, CA 95131, USA
Tel: 1(408) 441-0311
Fax: 1(408) 436-4314

Microcontrollers

2325 Orchard Parkway
San Jose, CA 95131, USA
Tel: 1(408) 441-0311
Fax: 1(408) 436-4314

La Chantrerie
BP 70602
44306 Nantes Cedex 3, France
Tel: (33) 2-40-18-18-18
Fax: (33) 2-40-18-19-60

ASIC/ASSP/Smart Cards

Zone Industrielle
13106 Rousset Cedex, France
Tel: (33) 4-42-53-60-00
Fax: (33) 4-42-53-60-01

1150 East Cheyenne Mtn. Blvd.
Colorado Springs, CO 80906, USA
Tel: 1(719) 576-3300
Fax: 1(719) 540-1759

Scottish Enterprise Technology Park
Maxwell Building
East Kilbride G75 0QR, Scotland
Tel: (44) 1355-803-000
Fax: (44) 1355-242-743

RF/Automotive

Theresienstrasse 2
Postfach 3535
74025 Heilbronn, Germany
Tel: (49) 71-31-67-0
Fax: (49) 71-31-67-2340

1150 East Cheyenne Mtn. Blvd.
Colorado Springs, CO 80906, USA
Tel: 1(719) 576-3300
Fax: 1(719) 540-1759

Biometrics/Imaging/Hi-Rel MPU/ High Speed Converters/RF Datacom

Avenue de Rochepleine
BP 123
38521 Saint-Egreve Cedex, France
Tel: (33) 4-76-58-30-00
Fax: (33) 4-76-58-34-80

Literature Requests

www.atmel.com/literature

Disclaimer: Atmel Corporation makes no warranty for the use of its products, other than those expressly contained in the Company's standard warranty which is detailed in Atmel's Terms and Conditions located on the Company's web site. The Company assumes no responsibility for any errors which may appear in this document, reserves the right to change devices or specifications detailed herein at any time without notice, and does not make any commitment to update the information contained herein. No licenses to patents or other intellectual property of Atmel are granted by the Company in connection with the sale of Atmel products, expressly or by implication. Atmel's products are not authorized for use as critical components in life support devices or systems.

© Atmel Corporation 2003. All rights reserved.

Atmel® and combinations thereof are the registered trademarks of Atmel Corporation or its subsidiaries.

Other terms and product names may be the trademarks of others.





Printed on recycled paper.

4748A-INDCO-08/03

Looking for pricing, stock, or lifecycle information?

Click below to explore more details on WIN SOURCE:

-  [View U490B](#) on WIN SOURCE
-  [Texas Instruments](#) Information

Optimize Your Supply Chain with WIN SOURCE Solutions

-  Global Sourcing Solution
-  Obsolete Management
-  Cost Control Management
-  Shortage Management
-  Alternative Solution
-  Excess Inventory Management