

## Features

- Wide Operating Voltage Range: 2V to 16V
- Low Current Consumption: 2.7 mA Typically
- Chip Disable Input to Power Down the Integrated Circuit
- Low Power-down Quiescent Current
- Drives a Wide Range of Speaker Loads
- Output Power  $P_o = 250$  mW at  $R_L = 32\Omega$  (Speaker)
- Low Harmonic Distortion (0.5% Typically)
- Wide Gain Range: 0 dB to 46 dB

## Benefits

- Low Number of External Components
- Low Current Consumption

## 1. Description

The integrated circuit U4083B is a low-power audio amplifier for telephone loudspeakers. It has differential speaker outputs to maximize the output swing at low supply voltages. There is no need for coupler capacitors. The U4083B has an open-loop gain of 80 dB where the closed-loop gain is adjusted with two external resistors. A chip disable pin permits powering down and/or muting the input signal.

Figure 1-1. Block Diagram

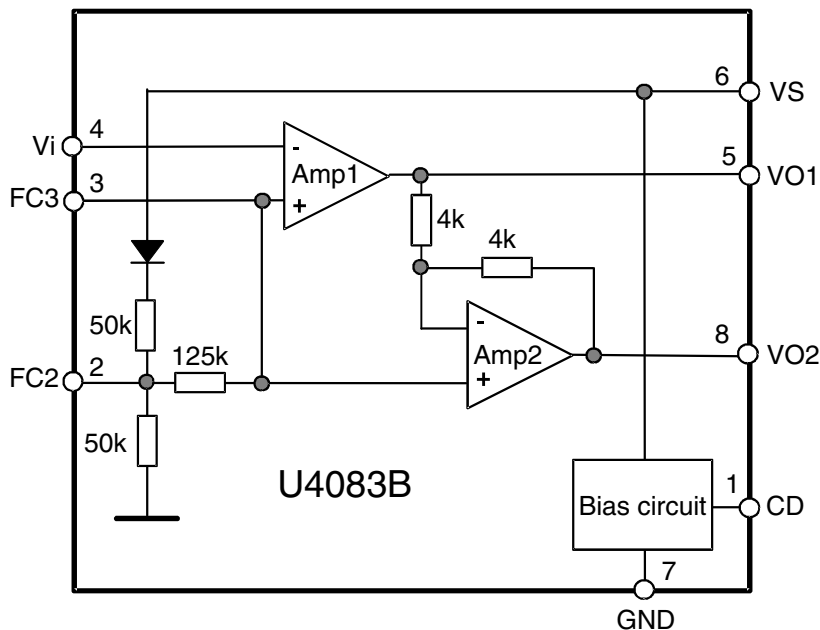

## Low-power Audio Amplifier for Telephone Applications

## U4083B

## 2. Pin Configuration

Figure 2-1. Pinning SO8

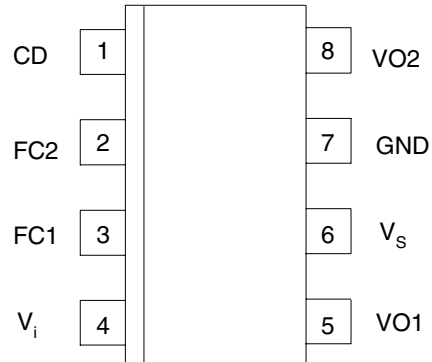

Table 2-1. Pin Description

Pin	Symbol	Function
1	CD	Chip disable
2	FC2	Filtering, power supply rejection
3	FC1	Filtering, power supply rejection
4	$V_i$	Amplifier input
5	VO1	Amplifier output 1
6	$V_s$	Voltage supply
7	GND	Ground
8	VO2	Amplifier output 2

### 3. Functional Description Including External Circuitry

#### 3.1 Pin 1: Chip Disable Digital Input (CD)

Pin 1 (chip disable) is used to power down the IC to conserve power or mute the IC or both.

Input impedance at Pin 1 is typically 90 k $\Omega$

- Logic 0 < 0.8V IC enabled (normal operation)
- Logic 1 > 2V IC disabled

[Figure 8-15 on page 12](#) shows the power supply current diagram. The change in differential gain from normal operation to muted operation (muting) is more than 70 dB.

Switching characteristics are as follows:

- Turn-on time  $t_{on} = 12 \text{ ms to } 15 \text{ ms}$
- Turn-off time  $t_{off} \leq 2 \mu\text{s}$

They are independent of  $C_1$ ,  $C_2$  and  $V_S$ .

Voltages at Pins 2 and 3 are supplied from  $V_S$  and, therefore, do not change when the U4083B is disabled. The outputs,  $V_{O1}$  (Pin 5) and  $V_{O2}$  (Pin 8), turn to a high impedance condition by removing the signal from the speaker.

When signals are applied from an external source to the outputs (disabled), they must not exceed the range between the supply voltage,  $V_S$ , and ground.

#### 3.2 Pins 2 and 3: Filtering, Power Supply Rejection

Power supply rejection is provided by capacitors  $C_1$  and  $C_2$  at Pin 3 and Pin 2, respectively.  $C_1$  is dominant at high frequencies whereas  $C_2$  is dominant at low frequencies ([Figure 8-4 on page 8](#) to [Figure 8-7 on page 9](#)). The values of  $C_1$  and  $C_2$  depend on the conditions of each application. For example, a line-powered speakerphone (telephone amplifier) will require more filtering than a system powered by regulated power supply.

The amount of rejection is a function of the capacitors and the equivalent impedance at Pin 3 and Pin 2 (see electrical characteristic equivalent resistance, R).

Apart from filtering, capacitors  $C_1$  and  $C_2$  also influence the turn-on time of the circuit at power up, since the capacitors are charged up through the internal resistors (50 k $\Omega$  and 125 k $\Omega$ ) as shown in the block diagram.

[Figure 8-1 on page 7](#) shows the turn-on time versus  $C_2$  at  $V_S = 6V$ , for two different  $C_1$  values.

The turn-on time is 60% longer when  $V_S = 3V$  and 20% shorter when  $V_S = 9V$ .

The turn-off time is less than 10  $\mu\text{s}$ .

### 3.3 Pin 4: Amplifier Input $V_i$ , Pin 5: Amplifier Output 1 $V_{O1}$ , Pin 8: Amplifier Output 2 $V_{O2}$

There are two identical operational amplifiers. Amplifier 1 has an open-loop gain  $\geq 80$  dB at 100Hz (Figure 8-2 on page 7), whereas the closed-loop gain is set by external resistors,  $R_f$  and  $R_i$  (Figure 8-3 on page 8). The amplifier is unity gain stable, and has a unity gain frequency of approximately 1.5 MHz. A closed-loop gain of 46 dB is recommended for a frequency range of 300Hz to 3400Hz (voice band). Amplifier 2 is internally set to a gain of  $-1.0$  dB (0 dB). The outputs of both amplifiers are capable of sourcing and sinking a peak current of 200 mA. Output voltage swing is between 0.4V and  $V_S - 1.3V$  at maximum current (Figure 8-18 on page 13 and Figure 8-19 on page 13).

The output DC offset voltage between Pins 5 and 8 ( $V_{O1} - V_{O2}$ ) is mainly a function of the feedback resistor,  $R_f$ , because the input offset voltages of the two amplifiers neutralize each other.

Bias current of Amplifier 1 which is constant with respect to  $V_S$ , flows out of Pin 4 ( $V_i$ ) and through  $R_f$ , forcing  $V_{O1}$  to shift negative by an amount equal to  $R_f I_{IB}$  and  $V_{O2}$  positive to an equal amount.

The output offset voltage specified in the electrical characteristics is measured with the feedback resistor ( $R_f = 75$  k $\Omega$ ) shown in the typical application circuit, Figure 8-20 on page 14. It takes into account the bias current as well as internal offset voltages of the amplifiers.

### 3.4 Pin 6: Supply and Power Dissipation

Power dissipation is shown in Figure 8-8 on page 9 to Figure 8-10 on page 10 for different loads. Distortion characteristics are given in Figure 8-11 on page 10 to Figure 8-13 on page 11.

$$P_{\text{totmax}} = \frac{T_{j\text{max}} - T_{\text{amb}}}{R_{\text{thJA}}}$$

where

$T_{j\text{max}}$  = Junction temperature = 140°C

$T_{\text{amb}}$  = Ambient temperature

$R_{\text{thJA}}$  = Thermal resistance, junction-ambient

Power dissipated within the IC in a given application is found from the following equation:

$$P_{\text{tot}} = (V_S \times I_S) + (I_{\text{RMS}} \times V_S) - (R_L \times I_{\text{RMS}}^2)$$

$I_S$  is obtained from Figure 8-15 on page 12.

$I_{\text{RMS}}$  is the RMS current at the load  $R_L$ .

The IC's operating range is defined by a peak operating load current of  $\pm 200$  mA (Figure 8-8 on page 9 to Figure 8-13 on page 11). It is further specified with respect to different loads (see Figure 8-14 on page 12). The left (ascending) portion of each of the three curves is defined by the power level at which 10% distortion occurs. The center flat portion of each curve is defined by the maximum output current capability of the integrated circuit. The right (descending) portion of each curve is defined by the maximum internal power dissipation of the IC at 25°C. At higher ambient temperatures, the maximum load power must be reduced according to the above mentioned equation.

## 3.5 Layout Considerations

Normally, a snubber is not needed at the output of the IC, unlike many other audio amplifiers. However, the PC-board layout, stray capacitances, and the manner in which the speaker wires are configured may dictate otherwise. Generally, the speaker wires should be twisted tightly, and should not be more than a few cm (or inches) in length.

## 4. Absolute Maximum Ratings

Stresses beyond those listed under “Absolute Maximum Ratings” may cause permanent damage to the device. This is a stress rating only and functional operation of the device at these or any other conditions beyond those indicated in the operational sections of this specification is not implied. Exposure to absolute maximum rating conditions for extended periods may affect device reliability.

Reference point pin 7,  $T_{amb} = 25^{\circ}\text{C}$  unless otherwise specified.

Parameters		Symbol	Value	Unit
Supply voltage	Pin 6	$V_S$	-1.0 to +18	V
Voltages Disabled	Pins 1, 2, 3 and 4		-1.0 to ( $V_S + 1.0$ )	V
	Pins 5 and 8		-1.0 to ( $V_S + 1.0$ )	V
Output current	Pins 5 and 8		$\pm 250$	mA
Junction temperature		$T_j$	+140	$^{\circ}\text{C}$
Storage temperature range		$T_{stg}$	-55 to +150	$^{\circ}\text{C}$
Ambient temperature range		$T_{amb}$	-20 to +70	$^{\circ}\text{C}$
Power dissipation SO8: $T_{amb} = 60^{\circ}\text{C}$		$P_{tot}$	440	mW

## 5. Thermal Resistance

Parameters		Symbol	Value	Unit
Junction ambient	SO8	$R_{thJA}$	180	K/W

## 6. Recommended Operating Conditions

Parameters		Symbol	Value	Unit
Supply voltage	Pin 6	$V_S$	2 to 16	V
Load impedance	Pins 5 to 8	$R_L$	8.0 to 100	$\Omega$
Load current		$I_L$	$\pm 200$	mA
Differential gain (5.0 kHz bandwidth)		DG	0 to 46	dB
Voltage at CD	Pin 1	$V_{CD}$	$V_S$	V
Ambient temperature range		$T_{amb}$	-20 to +70	$^{\circ}\text{C}$

## 7. Electrical Characteristics

$T_{amb} = +25^{\circ}\text{C}$ , reference point pin 7, unless otherwise specified

Parameters	Test Conditions	Symbol	Min.	Typ.	Max.	Unit
<b>Amplifiers (AC Characteristics)</b>						
Open-loop gain (Amplifier 1, $f < 100\text{Hz}$ )		$G_{VOL1}$	80			dB
Closed-loop gain (Amplifier 2)	$V_S = 6.0\text{V}$ , $f = 1.0\text{ kHz}$ , $R_L = 32\Omega$	$G_{V2}$	-0.35	0	+0.35	dB
Gain bandwidth product		$G_{BW}$		1.5		MHz
Output power	$V_S = 3.0\text{V}$ , $R_L = 16\Omega$ , $d < 10\%$	$P_O$	55			mW
	$V_S = 6.0\text{V}$ , $R_L = 32\Omega$ , $d < 10\%$	$P_O$	250			
	$V_S = 12\text{V}$ , $R_L = 100\Omega$ , $d < 10\%$	$P_O$	400			
Total harmonic distortion ( $f = 1.0\text{ kHz}$ )	$V_S = 6.0\text{V}$ , $R_L = 32\Omega$ , $P_o = 125\text{ mW}$	d		0.5		%
	$V_S > 3.0\text{V}$ , $R_L = 8\Omega$ , $P_o = 20\text{ mW}$	d		0.5	1.0	
	$V_S > 12\text{V}$ , $R_L = 32\Omega$ , $P_o = 200\text{ mW}$	d		0.6		
Power supply rejection ratio	$V_S = 6.0\text{V}$ , $\Delta V_S = 3.0\text{V}$ $C_1 = \alpha$ , $C_2 = 0.01\ \mu\text{F}$	PSRR	50	12		dB
	$C_1 = 0.1\ \mu\text{F}$ , $C_2 = 0$ , $f = 1.0\text{ kHz}$	PSRR				
	$C_1 = 1.0\ \mu\text{F}$ , $C_2 = 5.0\ \mu\text{F}$ , $f = 1.0\text{ kHz}$	PSRR				
Muting	$V_S = 6.0\text{V}$ , $1.0\text{ kHz} < f < 20\text{ kHz}$ , $CD = 2.0\text{V}$	$G_{MUTE}$		>70		dB
<b>Amplifiers (DC Characteristics)</b>						
Output DC level at $V_{O1}$ , $V_{O2}$ $R_f = 75\text{ k}\Omega$	$V_S = 3.0\text{V}$ , $R_L = 16\Omega$ $V_S = 6.0\text{V}$ $V_S = 12\text{V}$	$V_O$ $V_O$ $V_O$	1.0	1.15 2.65 5.65	1.25	V
Output high level	$I_O = -75\text{ mA}$ , $2.0\text{V} < V_S < 16\text{V}$	$V_{OH}$		$V_S - 1$		V
Output low level	$I_O = -75\text{ mA}$ , $2.0\text{V} < V_S < 16\text{V}$	$V_{OL}$		0.16		V
Output DC offset voltage ( $V_{O1} - V_{O2}$ )	$V_S = 6.0\text{V}$ , $R_f = 75\text{ k}\Omega$ , $R_L = 32\Omega$	$\Delta V_O$	-30	0	+30	mV
Input bias current at $V_i$	$V_S = 6.0\text{V}$	$-I_{IB}$		100	200	nA
Equivalent resistance at Pin 3	$V_S = 6.0\text{V}$	R	100	150	220	k $\Omega$
Equivalent resistance at Pin 2	$V_S = 6.0\text{V}$	R	18	25	40	k $\Omega$
Chip disable Pin 1 Input voltage low Input voltage high Input resistance	$V_S = V_{CD} = 16\text{V}$	$V_{IL}$			0.8	V
		$V_{IH}$	2.0			V
		$R_{CD}$	50	90	175	k $\Omega$
Power supply current	$V_S = 3.0\text{V}$ , $R_L = \alpha$ , $CD = 0.8\text{V}$	$I_S$			4.0	mA
	$V_S = 16\text{V}$ , $R_L = \alpha$ , $CD = 0.8\text{V}$	$I_S$			5.0	mA
	$V_S = 3.0\text{V}$ , $R_L = \alpha$ , $CD = 2.0\text{V}$	$I_S$		65	100	$\mu\text{A}$

### 8. Typical Temperature Performance

$T_{amb} = -20$  to  $+70^{\circ}C$

Function	Typical Change	Units
Input bias current at $V_i$	$\pm 40$	$\mu A/^{\circ}C$
Total harmonic distortion $V_S = 6.0V, R_L = 32 \Omega, P_o = 125 mW, f = 1.0 kHz$	+0.003	$\%/^{\circ}C$
Power supply current $V_S = 3.0V, R_L = \alpha, CD = 0V$ $V_S = 3.0V, R_L = \alpha, CD = 2.0V$	-2.5 -0.03	$\mu A/^{\circ}C$ $\mu A/^{\circ}C$

**Figure 8-1.** Turn-on Time versus  $C_1$  and  $C_2$  at Power On

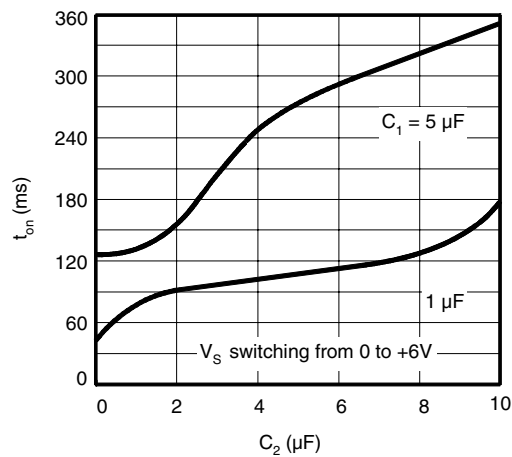

**Figure 8-2.** Amplifier 1 — Open-loop Gain and Phase

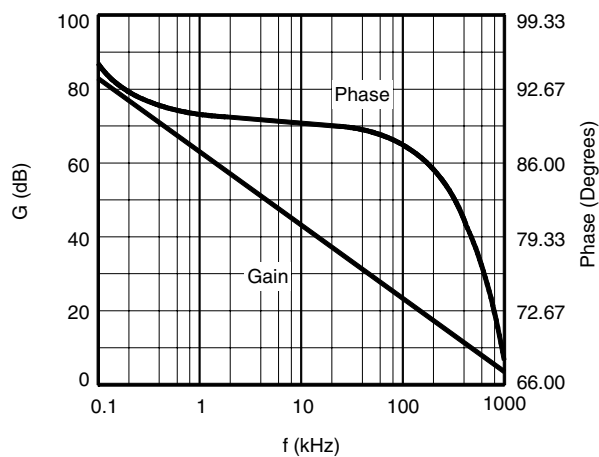

**Figure 8-3.** Differential Gain versus Frequency

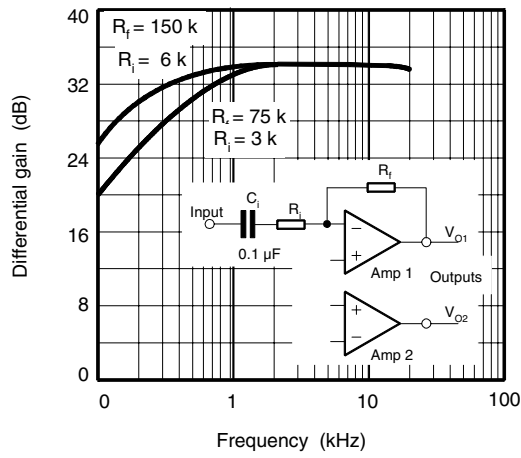

**Figure 8-4.** Power Supply Rejection versus Frequency —  $C_2 = 10\ \mu\text{F}$

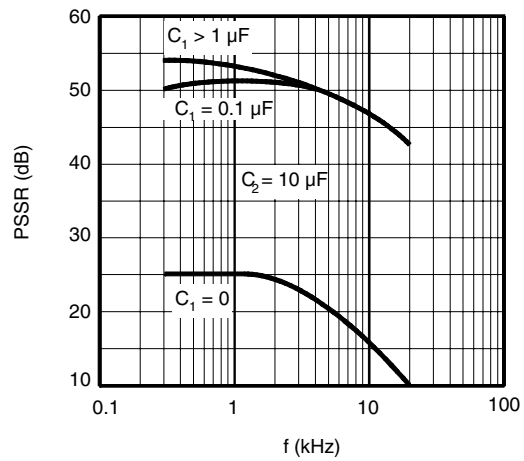

**Figure 8-5.** Power Supply Rejection versus Frequency —  $C_2 = 5\ \mu\text{F}$

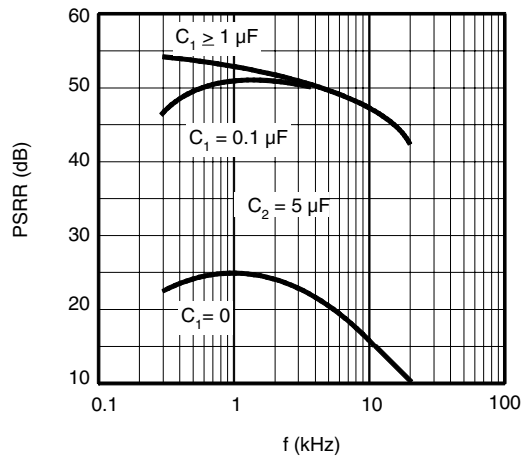

Figure 8-6. Power Supply Rejection versus Frequency —  $C_2 = 1 \mu\text{F}$

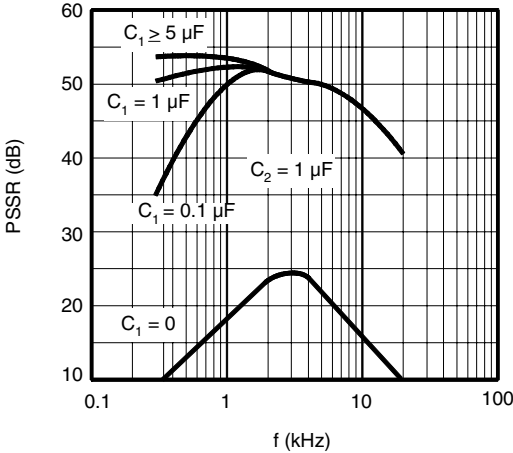

Figure 8-7. Power Supply Rejection versus Frequency —  $C_2 = 0$

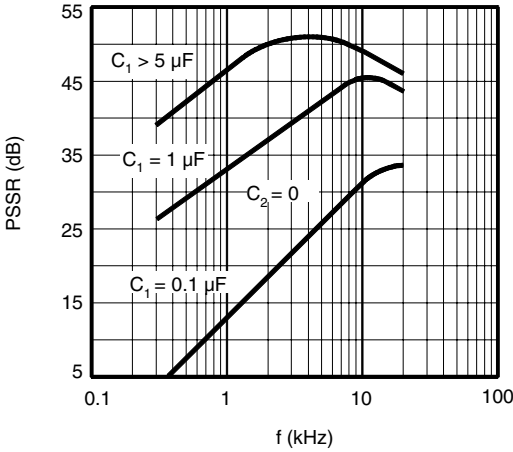
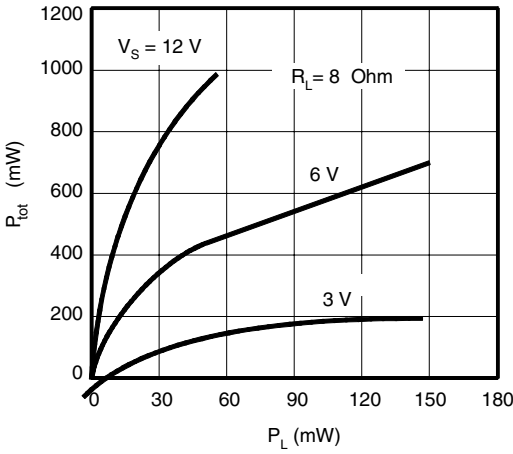
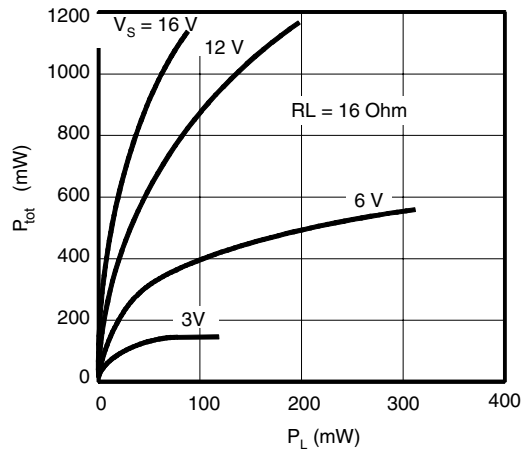

Figure 8-8. Device Dissipation —  $R_L = 8 \Omega$



**Figure 8-9.** Device Dissipation —  $R_L = 16\Omega$



**Figure 8-10.** Device Dissipation —  $R_L = 32\Omega$

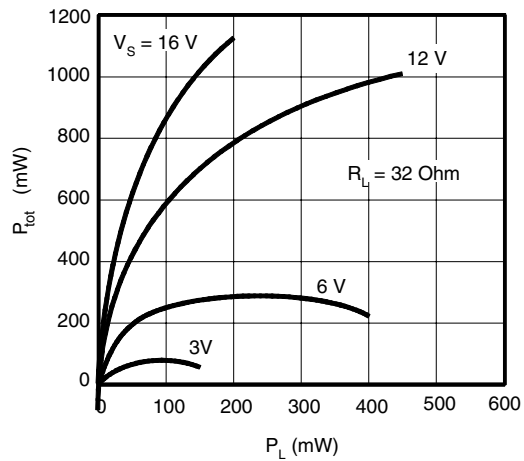

**Figure 8-11.** Distortion versus Power —  $f = 1\text{ kHz}$ ,  $\Delta - G_V = 34\text{ dB}$

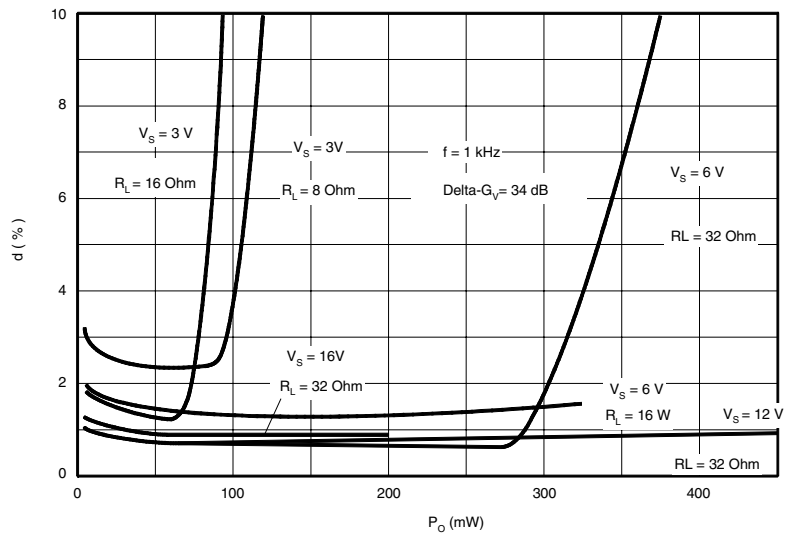

Figure 8-12. Distortion versus Power —  $f = 3 \text{ kHz}$ ,  $\Delta - G_V = 34 \text{ dB}$

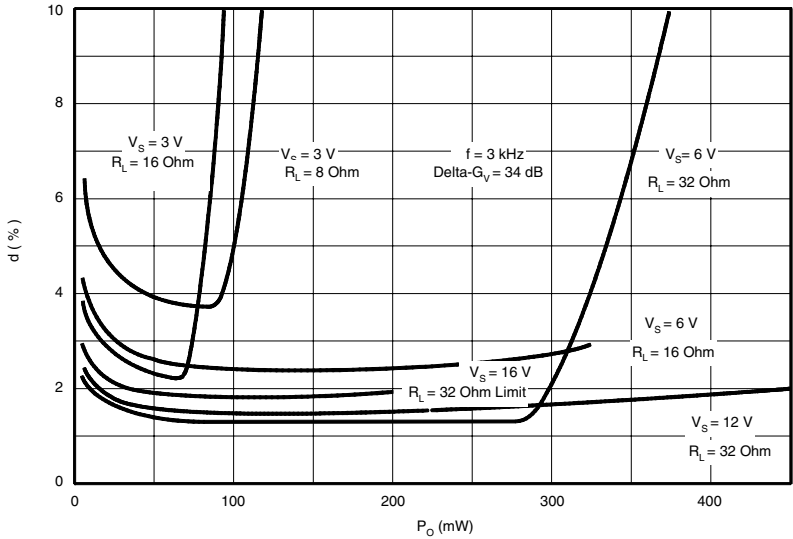
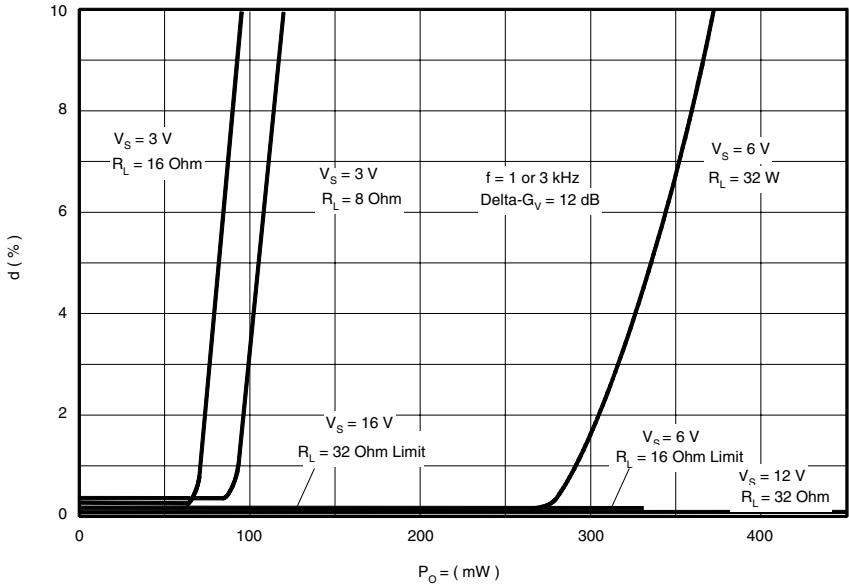
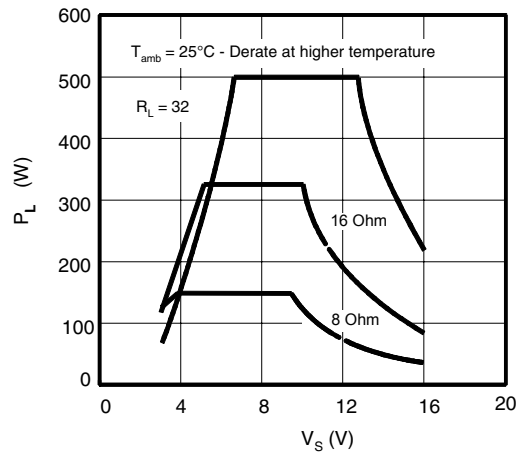

Figure 8-13. Distortion versus Power —  $f = 1 \text{ kHz}$  or  $3 \text{ kHz}$ ,  $\Delta - G_V = 12 \text{ dB}$



**Figure 8-14.** Maximum Allowable Load Power



**Figure 8-15.** Power-supply Current

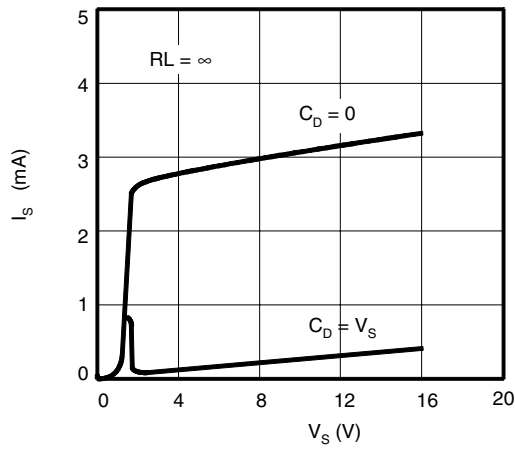

**Figure 8-16.** Small Signal Response

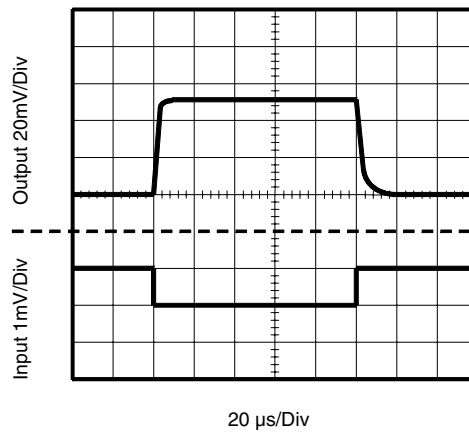

Figure 8-17. Large Signal Response

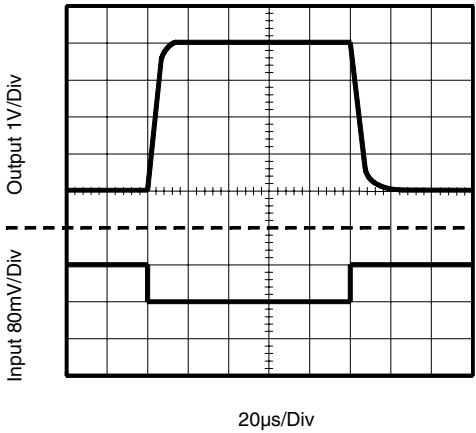

Figure 8-18.  $V_S - V_{OH}$  versus Load Current

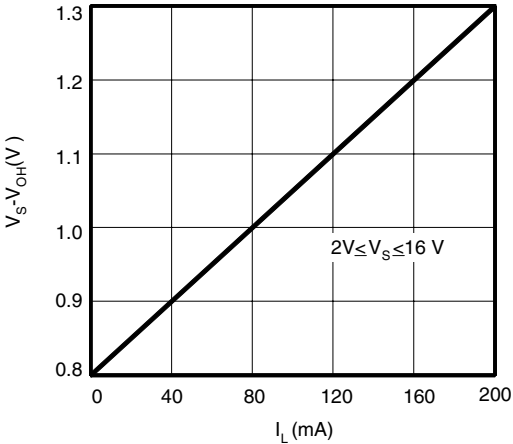

Figure 8-19.  $V_{OL}$  versus Load Current

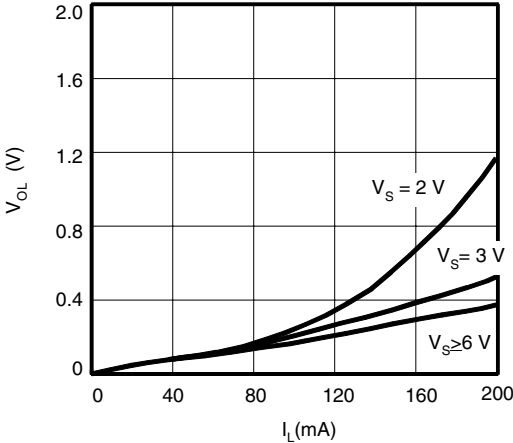
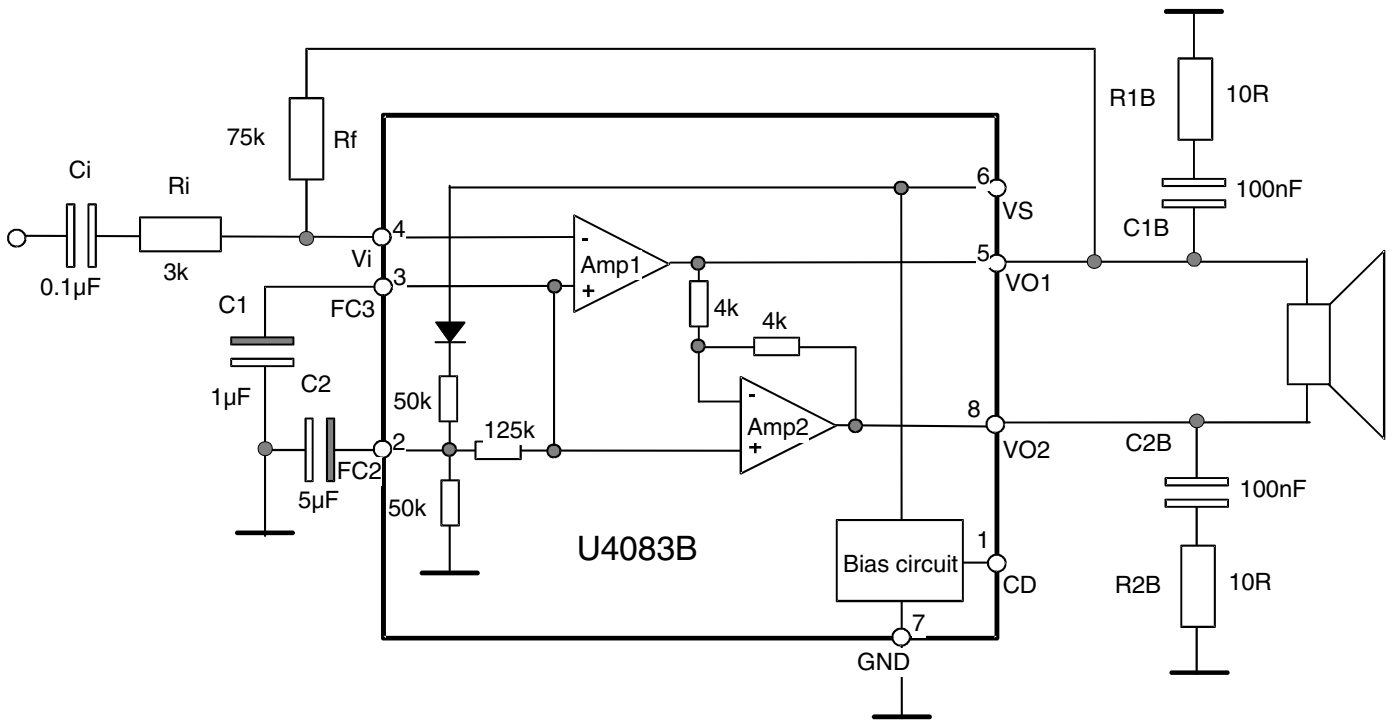

Figure 8-20. Application Circuit



**9. Ordering Information**

Extended Type Number	Package	Remarks
U4083B-MFPY	SO8, Pb-free	Tube
U4083B-MFPG3Y	SO8, Pb-free	Taped and reeled

**10. Package Information**

Package SO8

Dimensions in mm

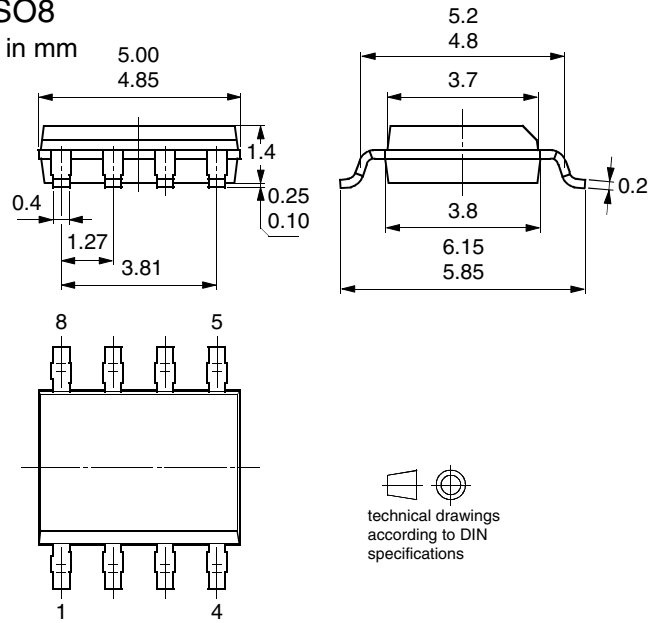



## Atmel Corporation

2325 Orchard Parkway  
San Jose, CA 95131, USA  
Tel: 1(408) 441-0311  
Fax: 1(408) 487-2600

## Regional Headquarters

### Europe

Atmel Sarl  
Route des Arsenaux 41  
Case Postale 80  
CH-1705 Fribourg  
Switzerland  
Tel: (41) 26-426-5555  
Fax: (41) 26-426-5500

### Asia

Room 1219  
Chinachem Golden Plaza  
77 Mody Road Tsimshatsui  
East Kowloon  
Hong Kong  
Tel: (852) 2721-9778  
Fax: (852) 2722-1369

### Japan

9F, Tonetsu Shinkawa Bldg.  
1-24-8 Shinkawa  
Chuo-ku, Tokyo 104-0033  
Japan  
Tel: (81) 3-3523-3551  
Fax: (81) 3-3523-7581

## Atmel Operations

### Memory

2325 Orchard Parkway  
San Jose, CA 95131, USA  
Tel: 1(408) 441-0311  
Fax: 1(408) 436-4314

### Microcontrollers

2325 Orchard Parkway  
San Jose, CA 95131, USA  
Tel: 1(408) 441-0311  
Fax: 1(408) 436-4314

La Chantrerie  
BP 70602  
44306 Nantes Cedex 3, France  
Tel: (33) 2-40-18-18-18  
Fax: (33) 2-40-18-19-60

### ASIC/ASSP/Smart Cards

Zone Industrielle  
13106 Rousset Cedex, France  
Tel: (33) 4-42-53-60-00  
Fax: (33) 4-42-53-60-01

1150 East Cheyenne Mtn. Blvd.  
Colorado Springs, CO 80906, USA  
Tel: 1(719) 576-3300  
Fax: 1(719) 540-1759

Scottish Enterprise Technology Park  
Maxwell Building  
East Kilbride G75 0QR, Scotland  
Tel: (44) 1355-803-000  
Fax: (44) 1355-242-743

### RF/Automotive

Theresienstrasse 2  
Postfach 3535  
74025 Heilbronn, Germany  
Tel: (49) 71-31-67-0  
Fax: (49) 71-31-67-2340

1150 East Cheyenne Mtn. Blvd.  
Colorado Springs, CO 80906, USA  
Tel: 1(719) 576-3300  
Fax: 1(719) 540-1759

### Biometrics/Imaging/Hi-Rel MPU/ High Speed Converters/RF Datacom

Avenue de Rochepleine  
BP 123  
38521 Saint-Egreve Cedex, France  
Tel: (33) 4-76-58-30-00  
Fax: (33) 4-76-58-34-80

---

### Literature Requests

[www.atmel.com/literature](http://www.atmel.com/literature)

**Disclaimer:** The information in this document is provided in connection with Atmel products. No license, express or implied, by estoppel or otherwise, to any intellectual property right is granted by this document or in connection with the sale of Atmel products. **EXCEPT AS SET FORTH IN ATMEL'S TERMS AND CONDITIONS OF SALE LOCATED ON ATMEL'S WEB SITE, ATMEL ASSUMES NO LIABILITY WHATSOEVER AND DISCLAIMS ANY EXPRESS, IMPLIED OR STATUTORY WARRANTY RELATING TO ITS PRODUCTS INCLUDING, BUT NOT LIMITED TO, THE IMPLIED WARRANTY OF MERCHANTABILITY, FITNESS FOR A PARTICULAR PURPOSE, OR NON-INFRINGEMENT. IN NO EVENT SHALL ATMEL BE LIABLE FOR ANY DIRECT, INDIRECT, CONSEQUENTIAL, PUNITIVE, SPECIAL OR INCIDENTAL DAMAGES (INCLUDING, WITHOUT LIMITATION, DAMAGES FOR LOSS OF PROFITS, BUSINESS INTERRUPTION, OR LOSS OF INFORMATION) ARISING OUT OF THE USE OR INABILITY TO USE THIS DOCUMENT, EVEN IF ATMEL HAS BEEN ADVISED OF THE POSSIBILITY OF SUCH DAMAGES.** Atmel makes no representations or warranties with respect to the accuracy or completeness of the contents of this document and reserves the right to make changes to specifications and product descriptions at any time without notice. Atmel does not make any commitment to update the information contained herein. Unless specifically provided otherwise, Atmel products are not suitable for, and shall not be used in, automotive applications. Atmel's products are not intended, authorized, or warranted for use as components in applications intended to support or sustain life.

© Atmel Corporation 2006. All rights reserved. Atmel®, logo and combinations thereof, Everywhere You Are® and others, are registered trademarks or trademarks of Atmel Corporation or its subsidiaries. Other terms and product names may be trademarks of others.



Printed on recycled paper.

4655C-CORD-03/06

## Looking for pricing, stock, or lifecycle information?

Click below to explore more details on WIN SOURCE:

 [View U4083B-MFPG3 on WIN SOURCE](#)

 [Atmel Information](#)

## Optimize Your Supply Chain with WIN SOURCE Solutions

-  Global Sourcing Solution
-  Obsolete Management
-  Cost Control Management
-  Shortage Management
-  Alternative Solution
-  Excess Inventory Management