



THE DATASHEET OF TXD2-12V



Panasonic
ideas for life

High breakdown voltage type
is available (1.5 kV between
open contacts)

TX-D RELAYS

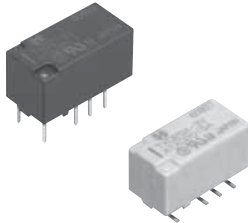

! Several part numbers will be discontinued
September 30, 2013.

FEATURES

- ! Lineup now includes high breakdown voltage type that achieves breakdown voltage between open contacts of 1,500 V AC.**
Surge breakdown voltage between open contacts:
1,500 V $10 \times 160 \mu\text{sec}$. (FCC part 68)
Surge breakdown voltage between contact and coil:
6,000 V $1.2 \times 50 \mu\text{sec}$. (EN60950)
- Approved to the supplementary insulation class in the EN standards (EN60950).**
The insulation distance between the contact and coil meet the supplementary insulation class of the EN60950 standards as required for equipment connected to the telephone lines in Europe.
Satisfies the following conditions:
 - Clearances: 2.0 mm .079 inch or more
 - Creepage distance: 2.5 mm .098 inch or more

- ! 3,000 V breakdown voltage between contact and coil. (Surge breakdown voltage 6,000 V type)**
The body block construction of the coil that is sealed formation offers a high breakdown voltage of 3,000 V between contact and coil.
- Nominal operating power: High sensitivity of 200 mW**
By using the highly efficient polar magnetic circuit "seesaw balance mechanism", a nominal operating power of 200 mW has been achieved.
- High contact capacity: 2 A 30 V DC**
- High contact reliability achieved with gold-clad crossbar twin contacts and the use of gas expelling materials during formation.**
*We also offer TX-series relays with AgPd contacts, suitable for use in low level load analog circuits.
- Outstanding vibration and shock resistance.**
Functional shock resistance: 750 m/s²
Destructive shock resistance:
1,000 m/s²
Functional vibration resistance:
10 to 55 Hz (at double amplitude of 3.3 mm .130 inch)
Destructive vibration resistance:
10 to 55 Hz (at double amplitude of 5 mm .197 inch)
- Sealed construction allows automatic washing.**
- A range of surface-mount types is also available.**
SA: Low-profile surface-mount terminal type
SS: Space saving surface-mount terminal type
- M.B.B. type available (Surge breakdown voltage 2,500 V type only)**

TYPICAL APPLICATIONS

- Facsimile
- Modem
- Communications (xDSL)
- Medical equipment
- Automotive equipment
- Security

ORDERING INFORMATION

TXD **2** □ - □ - □ - □ - □ - □ - □

Contact arrangement

2: 2 Form C

Surface-mount availability

Nil: Standard PC board terminal

SA: SA type SS: SS type

Operating function

Nil: Single side stable L: 1 coil latching

Type of operation

Nil: Standard type

2M: M.B.B. type (Surge breakdown voltage 2,500 V and Single side stable type only)

Terminal shape

Nil: Standard PC board terminal or surface-mount terminal

Nominal coil voltage (DC)

1.5, 3, 4.5, 5, 6, 9, 12, 24V

Contact material/Surge breakdown voltage (between contact and coil)/Breakdown (between open contacts)

Nil: Standard contact (Ag+Au clad), 2,500 V/1,000 V

1: AgPd contact (low level load); AgPd+Au clad (stationary), AgPd (movable), 2,500 V/1,000 V

3: Standard contact (Ag+Au clad), 6,000 V/1,500 V

4: AgPd contact (low level load); AgPd+Au clad (stationary), AgPd (movable), 6,000 V/1,500 V

(Discontinued Sept. 30, 2013)

6: Standard contact (Ag+Au clad), 6,000 V/1,000 V

7: AgPd contact (low level load); AgPd+Au clad (stationary), AgPd (movable), 6,000 V/1,000 V

Packing style

Nil: Tube packing

X: Tape and reel (picked from 1/3/4/5-pin side)

Z: Tape and reel packing (Picked from the 8/9/10/12-pin side)

Note: In case of 5 V transistor drive circuit, it is recommended to use 4.5 V type relay.

 Several part numbers will be discontinued September 30, 2013.

TYPES

1. Standard (B.B.M.) type/Surge breakdown voltage (between contact and coil) 2,500 V/ Breakdown voltage (between open contacts) 1,000 V

1) Standard PC board terminal

Contact arrangement	Nominal coil voltage	Single side stable	1 coil latching
		Part No.	Part No.
2 Form C	1.5V DC	TXD2-1.5V	TXD2-L-1.5V
	3V DC	TXD2-3V	TXD2-L-3V
	4.5V DC	TXD2-4.5V	TXD2-L-4.5V
	5V DC	TXD2-5V	TXD2-L-5V
	6V DC	TXD2-6V	TXD2-L-6V
	9V DC	TXD2-9V	TXD2-L-9V
	12V DC	TXD2-12V	TXD2-L-12V
	24V DC	TXD2-24V	TXD2-L-24V

Standard packing: Tube: 40 pcs.; Case: 1,000 pcs.

Note: Please add "-1" to the end of the part number for AgPd contacts (low level load).

2) Surface-mount terminal

(1) Tube packing

Contact arrangement	Nominal coil voltage	Single side stable	1 coil latching
		Part No.	Part No.
2 Form C	1.5V DC	TXD2S□-1.5V	TXD2S□-L-1.5V
	3V DC	TXD2S□-3V	TXD2S□-L-3V
	4.5V DC	TXD2S□-4.5V	TXD2S□-L-4.5V
	5V DC	TXD2S□-5V	TXD2S□-L-5V
	6V DC	TXD2S□-6V	TXD2S□-L-6V
	9V DC	TXD2S□-9V	TXD2S□-L-9V
	12V DC	TXD2S□-12V	TXD2S□-L-12V
	24V DC	TXD2S□-24V	TXD2S□-L-24V

□: For each surface-mount terminal identification, input the following letter. SA type: A, SS type: S

Standard packing: Tube: 40 pcs.; Case: 1,000 pcs.

Note: Please add "-1" to the end of the part number for AgPd contacts (low level load).

(2) Tape and reel packing

Contact arrangement	Nominal coil voltage	Single side stable	1 coil latching
		Part No.	Part No.
2 Form C	1.5V DC	TXD2S□-1.5V-Z	TXD2S□-L-1.5V-Z
	3V DC	TXD2S□-3V-Z	TXD2S□-L-3V-Z
	4.5V DC	TXD2S□-4.5V-Z	TXD2S□-L-4.5V-Z
	5V DC	TXD2S□-5V-Z	TXD2S□-L-5V-Z
	6V DC	TXD2S□-6V-Z	TXD2S□-L-6V-Z
	9V DC	TXD2S□-9V-Z	TXD2S□-L-9V-Z
	12V DC	TXD2S□-12V-Z	TXD2S□-L-12V-Z
	24V DC	TXD2S□-24V-Z	TXD2S□-L-24V-Z

□: For each surface-mount terminal identification, input the following letter. SA type: A, SS type: S

Standard packing: Tape and reel: 500 pcs.; Case: 1,000 pcs.

Notes: 1. Tape and reel packing symbol "-Z" is not marked on the relay. "X" type tape and reel packing (picked from 1/3/4/5-pin side) is also available.

2. Please add "-1" to the part number for AgPd contacts (low level load). (Ex. TXD2SA-1.5V-1-Z)

2. M.B.B type/Surge breakdown voltage (between contact and coil) 2,500 V/

Breakdown voltage (between open contacts) 1,000 V

1) Standard PC board terminal

Contact arrangement	Nominal coil voltage	Single side stable
		Part No.
2 Form C	1.5V DC	TXD2-2M-1.5V
	3V DC	TXD2-2M-3V
	4.5V DC	TXD2-2M-4.5V
	5V DC	TXD2-2M-5V
	6V DC	TXD2-2M-6V
	9V DC	TXD2-2M-9V
	12V DC	TXD2-2M-12V
	24V DC	TXD2-2M-24V

Standard packing: Tube: 40 pcs.; Case: 1,000 pcs.

2) Surface-mount terminal

(1) Tube packing

Contact arrangement	Nominal coil voltage	Single side stable
		Part No.
2 Form C	1.5V DC	TXD2S□-2M-1.5V
	3V DC	TXD2S□-2M-3V
	4.5V DC	TXD2S□-2M-4.5V
	5V DC	TXD2S□-2M-5V
	6V DC	TXD2S□-2M-6V
	9V DC	TXD2S□-2M-9V
	12V DC	TXD2S□-2M-12V
	24V DC	TXD2S□-2M-24V

□: For each surface-mount terminal identification, input the following letter. SA type: A, SS type: S

Standard packing: Tube: 40 pcs.; Case: 1,000 pcs.

(2) Tape and reel packing

Contact arrangement	Nominal coil voltage	Single side stable
		Part No.
2 Form C	1.5V DC	TXD2S□-2M-1.5V-Z
	3V DC	TXD2S□-2M-3V-Z
	4.5V DC	TXD2S□-2M-4.5V-Z
	5V DC	TXD2S□-2M-5V-Z
	6V DC	TXD2S□-2M-6V-Z
	9V DC	TXD2S□-2M-9V-Z
	12V DC	TXD2S□-2M-12V-Z
	24V DC	TXD2S□-2M-24V-Z

□: For each surface-mount terminal identification, input the following letter. SA type: A, SS type: S

Standard packing: Tape and reel: 500 pcs.; Case: 1,000 pcs.

Notes: 1. Types designed to withstand strong vibration caused, for example, by the use of terminal cutters, can also be ordered.

However, please contact us if you need parts for use in low level load. (Ex. TXD2SA-2M-1.5V-1-Z)

2. Tape and reel packing symbol "-Z" is not marked on the relay. "X" type tape and reel packing (picked from 1/3/4/5-pin side) is also available.

3.  Standard (B.B.M.) type/Surge breakdown voltage (between contact and coil) 6,000 V/
Breakdown voltage (between open contacts) 1,000 V
1) Standard PC board terminal

Contact arrangement	Nominal coil voltage	Single side stable	1 coil latching
		Part No.	Part No.
2 Form C	1.5V DC	TXD2-1.5V-6	TXD2-L-1.5V-6
	3V DC	TXD2-3V-6	TXD2-L-3V-6
	4.5V DC	TXD2-4.5V-6	TXD2-L-4.5V-6
	5V DC	TXD2-5V-6	TXD2-L-5V-6
	6V DC	TXD2-6V-6	TXD2-L-6V-6
	9V DC	TXD2-9V-6	TXD2-L-9V-6
	12V DC	TXD2-12V-6	TXD2-L-12V-6
	24V DC	TXD2-24V-6	TXD2-L-24V-6

Standard packing: Tube: 40 pcs.; Case: 1,000 pcs.

Note: Please add "-7" to the end of the part number for AgPd contacts (low level load).

2) Surface-mount terminal
(1) Tube packing

Contact arrangement	Nominal coil voltage	Single side stable	1 coil latching
		Part No.	Part No.
2 Form C	1.5V DC	TXD2S□-1.5V-6	TXD2S□-L-1.5V-6
	3V DC	TXD2S□-3V-6	TXD2S□-L-3V-6
	4.5V DC	TXD2S□-4.5V-6	TXD2S□-L-4.5V-6
	5V DC	TXD2S□-5V-6	TXD2S□-L-5V-6
	6V DC	TXD2S□-6V-6	TXD2S□-L-6V-6
	9V DC	TXD2S□-9V-6	TXD2S□-L-9V-6
	12V DC	TXD2S□-12V-6	TXD2S□-L-12V-6
	24V DC	TXD2S□-24V-6	TXD2S□-L-24V-6

 □: For each surface-mount terminal identification, input the following letter. SA type: A; SS type: S

Standard packing: Tube: 40 pcs.; Case: 1,000 pcs.

Note: Please add "-7" to the end of the part number for AgPd contacts (low level load).

(2) Tape and reel packing

Contact arrangement	Nominal coil voltage	Single side stable	1 coil latching
		Part No.	Part No.
2 Form C	1.5V DC	TXD2S□-1.5V-6-Z	TXD2S□-L-1.5V-6-Z
	3V DC	TXD2S□-3V-6-Z	TXD2S□-L-3V-6-Z
	4.5V DC	TXD2S□-4.5V-6-Z	TXD2S□-L-4.5V-6-Z
	5V DC	TXD2S□-5V-6-Z	TXD2S□-L-5V-6-Z
	6V DC	TXD2S□-6V-6-Z	TXD2S□-L-6V-6-Z
	9V DC	TXD2S□-9V-6-Z	TXD2S□-L-9V-6-Z
	12V DC	TXD2S□-12V-6-Z	TXD2S□-L-12V-6-Z
	24V DC	TXD2S□-24V-6-Z	TXD2S□-L-24V-6-Z

 □: For each surface-mount terminal identification, input the following letter. SA type: A; SS type: S

Standard packing: Tape and reel: 500 pcs.; Case: 1,000 pcs.

Notes: 1. Tape and reel packing symbol "-Z" is not marked on the relay. "X" type tape and reel packing (picked from 1/3/4/5-pin side) is also available.

2. Please add "-7" to the part number for AgPd contacts (low level load). (Ex. TXD2SA-1.5V-7-Z)

**4. ⚠ Standard (B.B.M.) type/Surge breakdown voltage (between contact and coil) 6,000 V/
Breakdown voltage (between open contacts) 1,500 V (High breakdown voltage type)**

1) Standard PC board terminal

Contact arrangement	Nominal coil voltage	Single side stable	1 coil latching
		Part No.	Part No.
2 Form C	1.5V DC	TXD2-1.5V-3	TXD2-L-1.5V-3
	3V DC	TXD2-3V-3	TXD2-L-3V-3
	4.5V DC	TXD2-4.5V-3	TXD2-L-4.5V-3
	5V DC	TXD2-5V-3	TXD2-L-5V-3
	6V DC	TXD2-6V-3	TXD2-L-6V-3
	9V DC	TXD2-9V-3	TXD2-L-9V-3
	12V DC	TXD2-12V-3	TXD2-L-12V-3
	24V DC	TXD2-24V-3	TXD2-L-24V-3

Standard packing: Tube: 40 pcs.; Case: 800 pcs.

Note: Please add "-4" to the end of the part number for AgPd contacts (low level load).

2) Surface-mount terminal

(1) Tube packing

Contact arrangement	Nominal coil voltage	Single side stable	1 coil latching
		Part No.	Part No.
2 Form C	1.5V DC	TXD2S□-1.5V-3	TXD2S□-L-1.5V-3
	3V DC	TXD2S□-3V-3	TXD2S□-L-3V-3
	4.5V DC	TXD2S□-4.5V-3	TXD2S□-L-4.5V-3
	5V DC	TXD2S□-5V-3	TXD2S□-L-5V-3
	6V DC	TXD2S□-6V-3	TXD2S□-L-6V-3
	9V DC	TXD2S□-9V-3	TXD2S□-L-9V-3
	12V DC	TXD2S□-12V-3	TXD2S□-L-12V-3
	24V DC	TXD2S□-24V-3	TXD2S□-L-24V-3

□: For each surface-mount terminal identification, input the following letter. SA type: A, SS type: S

Standard packing: Tube: 40 pcs.; Case: 800 pcs.

Note: Please add "-4" to the end of the part number for AgPd contacts (low level load).

(2) Tape and reel packing

Contact arrangement	Nominal coil voltage	Single side stable	1 coil latching
		Part No.	Part No.
2 Form C	1.5V DC	TXD2SA-1.5V-3-Z	TXD2SA-L-1.5V-3-Z
	3V DC	TXD2SA-3V-3-Z	TXD2SA-L-3V-3-Z
	4.5V DC	TXD2SA-4.5V-3-Z	TXD2SA-L-4.5V-3-Z
	5V DC	TXD2SA-5V-3-Z	TXD2SA-L-5V-3-Z
	6V DC	TXD2SA-6V-3-Z	TXD2SA-L-6V-3-Z
	9V DC	TXD2SA-9V-3-Z	TXD2SA-L-9V-3-Z
	12V DC	TXD2SA-12V-3-Z	TXD2SA-L-12V-3-Z
	24V DC	TXD2SA-24V-3-Z	TXD2SA-L-24V-3-Z

*Only for SA type.

Standard packing: Tape and reel: 500 pcs.; Case: 1,000 pcs.

Notes: 1. Tape and reel packing symbol "-Z" is not marked on the relay. "X" type tape and reel packing (picked from 1/3/4/5-pin side) is also available.

2. Please add "-4" to the part number for AgPd contacts (low level load). (Ex. TXD2SA-1.5V-4-Z)

RATING

1. Coil data

[Standard (B.B.M.) type]

1) Single side stable

Nominal coil voltage	Pick-up voltage (at 20°C 68°F)	Drop-out voltage (at 20°C 68°F)	Nominal operating current [±10%] (at 20°C 68°F)		Coil resistance [±10%] (at 20°C 68°F)		Nominal operating power		Max. applied voltage (at 20°C 68°F)
			Surge breakdown voltage: 2,500V/ ⚠ 6,000 V	⚠ Surge breakdown voltage: 6,000 V (High breakdown voltage)	Surge breakdown voltage: 2,500V/ ⚠ 6,000 V	⚠ Surge breakdown voltage: 6,000 V (High breakdown voltage)	Surge breakdown voltage: 2,500V/ ⚠ 6,000 V	⚠ Surge breakdown voltage: 6,000 V (High breakdown voltage)	
1.5V DC	75%V or less of nominal voltage* (Initial)	10%V or more of nominal voltage* (Initial)	132.7mA	187.5mA	11Ω	8Ω	200mW	280mW	120%V of nominal voltage
3V DC			66.7mA	93.5mA	45Ω	32Ω			
4.5V DC			44.4mA	62.5mA	101Ω	72Ω			
5V DC			40.0mA	56.2mA	125Ω	89Ω			
6V DC			33.3mA	46.5mA	180Ω	129Ω			
9V DC			22.2mA	31.1mA	405Ω	289Ω			
12V DC			16.7mA	23.3mA	720Ω	514Ω			
24V DC			9.6mA	12.9mA	2,504Ω	1,858Ω			

2) 1 coil latching

Nominal coil voltage	Set voltage (at 20°C 68°F)	Reset voltage (at 20°C 68°F)	Nominal operating current [±10%] (at 20°C 68°F)		Coil resistance [±10%] (at 20°C 68°F)		Nominal operating power		Max. applied voltage (at 20°C 68°F)
			Surge breakdown voltage: 2,500V/ ⚠ 6,000 V	⚠ Surge breakdown voltage: 6,000 V (High breakdown voltage)	Surge breakdown voltage: 2,500V/ ⚠ 6,000 V	⚠ Surge breakdown voltage: 6,000 V (High breakdown voltage)	Surge breakdown voltage: 2,500V/ ⚠ 6,000 V	Surge breakdown voltage: 6,000 V (High breakdown voltage)	
1.5V DC	75%V or less of nominal voltage* (Initial)	75%V or less of nominal voltage* (Initial)	100.0mA	153.1mA	15Ω	10Ω	150mW	230mW	120%V of nominal voltage
3V DC			50.0mA	76.9mA	60Ω	39Ω			
4.5V DC			33.3mA	51.1mA	135Ω	88Ω			
5V DC			30.0mA	46.3mA	166Ω	109Ω			
6V DC			25.0mA	38.5mA	240Ω	156Ω			
9V DC			16.7mA	25.6mA	540Ω	352Ω			
12V DC			12.5mA	19.2mA	960Ω	626Ω			
24V DC			7.1mA	10.4mA	3,388Ω	2,304Ω			

[M.B.B. type]

Nominal coil voltage	Pick-up voltage (at 20°C 68°F)	Drop-out voltage (at 20°C 68°F)	Nominal operating current [±10%] (at 20°C 68°F)	Coil resistance [±10%] (at 20°C 68°F)	Nominal operating power	Max. applied voltage (at 20°C 68°F)
1.5V DC	75%V or less of nominal voltage* (Initial)	10%V or more of nominal voltage* (Initial)	166.7mA	9Ω	250mW	120%V of nominal voltage
3V DC			83.3mA	36Ω		
4.5V DC			55.6mA	81Ω		
5V DC			50.0mA	100Ω		
6V DC			41.7mA	144Ω		
9V DC			27.8mA	324Ω		
12V DC			20.8mA	576Ω		
24V DC			11.3mA	2,133Ω		

*Pulse drive (JIS C 5442-1986)

*Only for surge breakdown voltage of 2,500 V.

2. Specifications

Characteristics	Item		Specifications		
Contact	Arrangement		2 Form C	2 Form D (M.B.B.type) ^{*1}	
	Contact resistance (Initial)		Max. 100 mΩ (By voltage drop 6 V DC 1A)		
	Contact material		Standard contact: Ag+Au clad, AgPd contact (low level load): AgPd+Au clad (stationary), AgPd (movable)		
Rating	Nominal switching capacity		Standard contact: 2 A 30 V DC, AgPd contact: 1 A 30 V DC (resistive load)	1 A 30 V DC (resistive load)	
	Max. switching power		Standard contact: 60 W (DC), AgPd contact: 30 W (DC) (resistive load)	30 W (DC) (resistive load)	
	Max. switching voltage		220 V DC		
	Max. switching current		Standard contact: 2 A, AgPd contact: 1 A	1 A	
	Min. switching capacity (Reference value) ^{*2}		10μA10mV DC		
	Nominal operating power	Single side stable	Surge breakdown voltage 2,500 V and ⚠ 6,000 V types: 200mW (1.5 to 12 V DC), 230mW (24 V DC) Surge breakdown voltage ⚠ 6,000 V (High breakdown voltage) type: 280mW (1.5 to 12 V DC), 310mW (24 V DC)	250mW (1.5 to 12 V DC), 270mW (24 V DC)	
		1 coil latching	Surge breakdown voltage 2,500 V and ⚠ 6,000 V types: 150mW (1.5 to 12 V DC), 170mW (24 V DC) Surge breakdown voltage ⚠ 6,000 V (High breakdown voltage) type: 230mW (1.5 to 12 V DC), 250mW (24 V DC)	—	
Electrical characteristics	Insulation resistance (Initial)		Min. 1,000MΩ (at 500V DC) Measurement at same location as "Initial breakdown voltage" section.		
	Breakdown voltage (Initial)	Between open contacts	Surge breakdown voltage 2,500 V and ⚠ 6,000 V types: 1,000 Vrms for 1min. (Detection current: 10mA) Surge breakdown voltage ⚠ 6,000 V (High breakdown voltage) type: 1,500 Vrms for 1min. (Detection current: 10mA)	500 Vrms for 1min. (Detection current: 10mA)	
		Between contact and coil	Surge breakdown voltage 2,500 V type: 2,000 Vrms for 1min. (Detection current: 10mA) Surge breakdown voltage ⚠ 6,000 V and ⚠ 6,000 V (High breakdown voltage) types: 3,000 Vrms for 1min. (Detection current: 10mA)	2,000 Vrms for 1min. (Detection current: 10mA)	
		Between contact sets	1,000 Vrms for 1min. (Detection current: 10mA)		
	Surge breakdown voltage (Initial)	Between open contacts	1,500 V (10×160μs) (FCC Part 68)		—
		Between contacts and coil ^{*1}	Surge breakdown voltage 2,500 V type: 2,500 V, 2 × 10μs (Telcordia) Surge breakdown voltage 6,000 V and 6,000 V (High breakdown voltage) types: 6,000 V, 1.2 × 50μs	2,500 V, 2 × 10μs (Telcordia)	
	Temperature rise (at 20°C 68°F)		Max. 50°C 122°F (By resistive method, nominal coil voltage applied to the coil; contact carrying current: 2A [1A: M.B.B.])		
Operate time [Set time] (at 20°C 68°F)		Max. 4 ms [Max. 4 ms] (Nominal coil voltage applied to the coil, excluding contact bounce time.)			
Release time [Reset time] (at 20°C 68°F)		Max. 4 ms [Max. 4 ms] (Nominal coil voltage applied to the coil, excluding contact bounce time.) (without diode)			
Mechanical characteristics	Shock resistance	Functional	Min. 750 m/s ² (Half-wave pulse of sine wave: 6 ms; detection time: 10μs.)	Min. 500 m/s ² (Half-wave pulse of sine wave: 11 ms; detection time: 10μs.)	
		Destructive	Min. 1,000 m/s ² {100G} (Half-wave pulse of sine wave: 6 ms.)		
	Vibration resistance	Functional	10 to 55 Hz at double amplitude of 3.3 mm (Detection time: 10μs.)		
		Destructive	10 to 55 Hz at double amplitude of 5 mm		
Expected life	Mechanical	Min. 10 ⁸ (at 180 cpm)		Min. 10 ⁷ (at 180 cpm)	
	Electrical	Min. 10 ⁵ (2 A 30 V DC resistive), Min. 5×10 ⁵ (1 A 30 V DC resistive) (at 20 cpm)	Min. 10 ⁵ (1 A 30 V DC resistive) (at 20 cpm)		
Conditions	Conditions for operation, transport and storage ^{*3}		Ambient temperature: -40°C to +85°C -40°F to +185°F; Humidity: 5 to 85% R.H. (Not freezing and condensing at low temperature)		
	Max. operating speed (at rated load)		20 cpm		
Unit weight		Approx. 2 g .071 oz			

*1 M.B.B. type models are only available in 2,500 V surge breakdown voltage type.

*2 This value can change due to the switching frequency, environmental conditions, and desired reliability level, therefore it is recommended to check this with the actual load. (AgPd contact type is available for low level load switching.)

*3The upper operation ambient temperature limit is the maximum temperature that can satisfy the coil temperature rise value. Refer to "6. Usage, Storage and Transport Conditions" in [AMBIENT ENVIRONMENT section in Relay Technical Information](#).

REFERENCE DATA

1. Maximum switching capacity

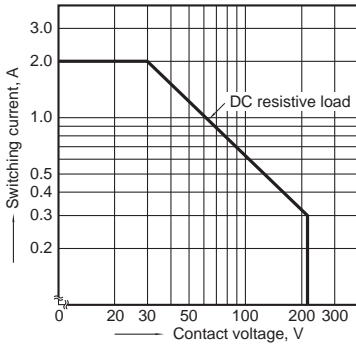

2. Life curve

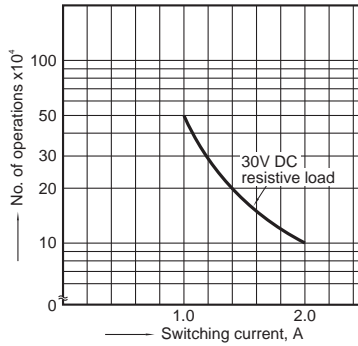

3. Mechanical life

Tested sample: TXD2-5V, 10 pcs.
Operating speed: 180 cpm

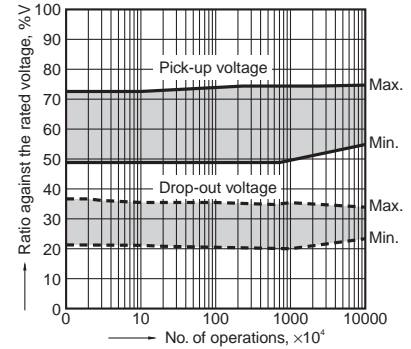

4. Electrical life (2 A 30 V DC resistive load)

Tested sample: TXD2-5V, 6 pcs.
Operating speed: 20 cpm

Change of pick-up and drop-out voltage

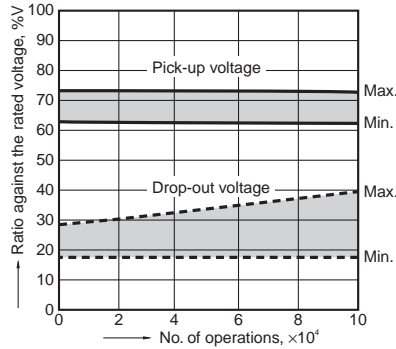

Change of contact resistance

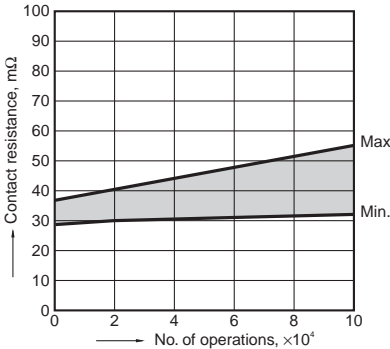

5-(1). Coil temperature rise

Tested sample: TXD2-5V, 6 pcs.
Measured portion: Inside the coil
Ambient temperature: 25°C 77°F, 70°C 158°F

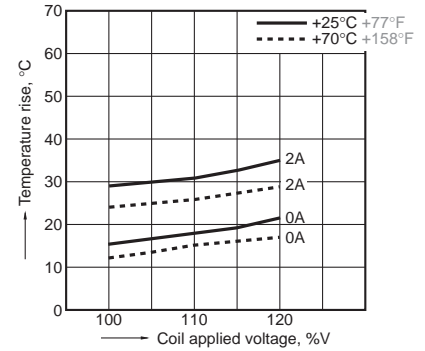

5-(2). Coil temperature rise

Tested sample: TXD2-24V, 6 pcs.
Measured portion: Inside the coil
Ambient temperature: 25°C 77°F, 70°C 158°F

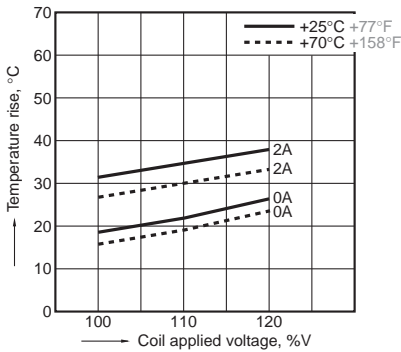

6-(1). Operate/release time characteristics (with diode)

Tested sample: TXD2-5V, 10 pcs.

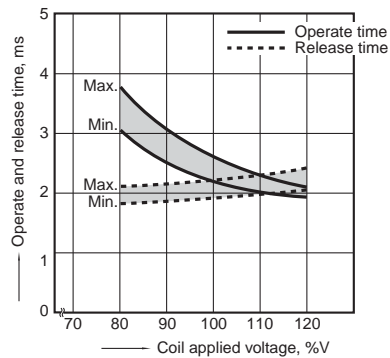

6-(2). Operate/release time characteristics (without diode)

Tested sample: TXD2-5V, 10 pcs.

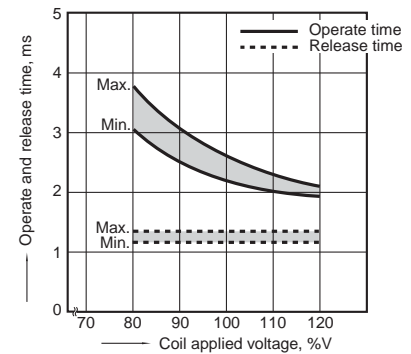

7. Ambient temperature characteristics

Tested sample: TXD2-5V, 5 pcs.

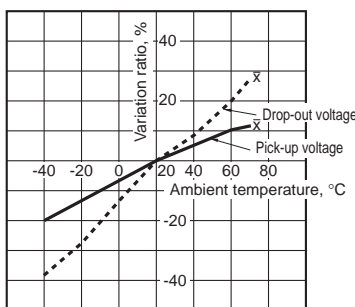

8. High-frequency characteristics (Isolation)

Tested sample: TXD2-12V, 2 pcs.

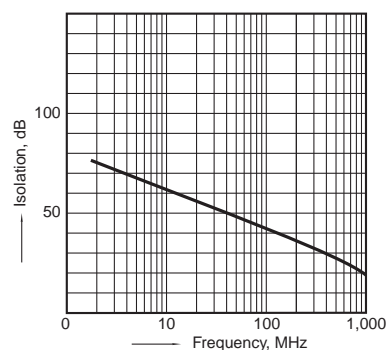

9. High-frequency characteristics (Insertion loss)

Tested sample: TXD2-12V, 2 pcs.

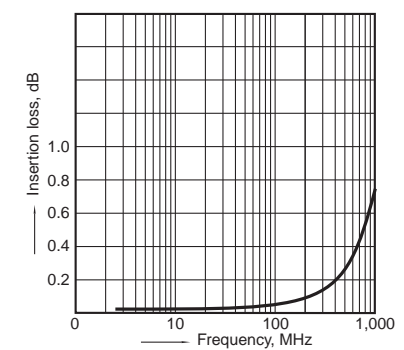

10. Malfunctional shock (single side stable)
Tested sample: TXD2-5V, 6 pcs

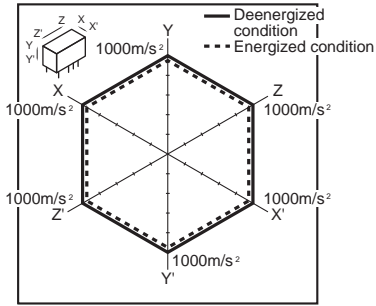

11-(1). Influence of adjacent mounting
Tested sample: TXD2-12V, 6 pcs.

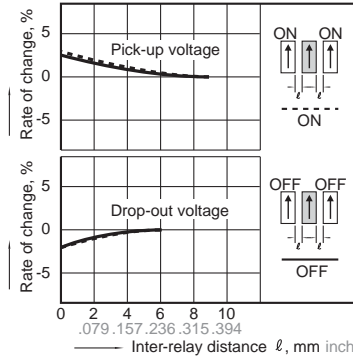

11-(2). Influence of adjacent mounting
Tested sample: TXD2-12V, 6 pcs.

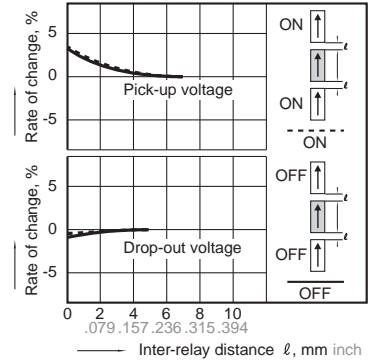

12. Actual load test (35 mA 48 V DC wire spring relay load)
Tested sample: TXD2-5V, 6 pcs.

Circuit

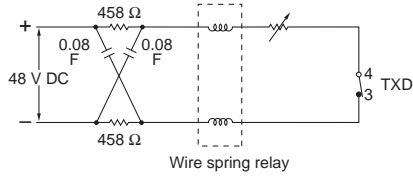

Change of pick-up and drop-out voltage

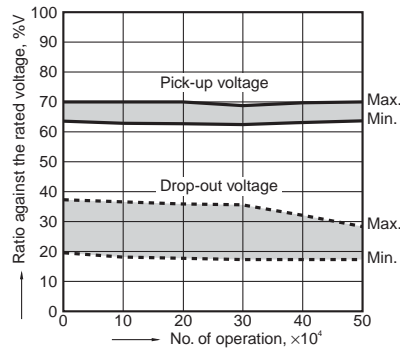

Change of contact resistance

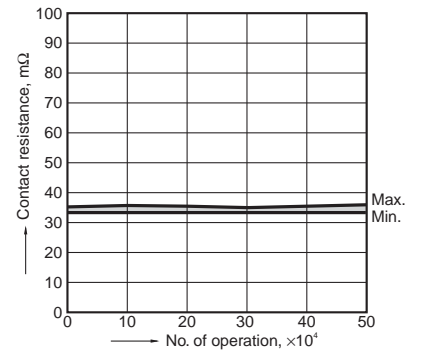

13-(1). Distribution of M.B.B. time
Tested sample: TXD2-2M-5V, 50 pcs.
Terminal No. 3-4-5: ON

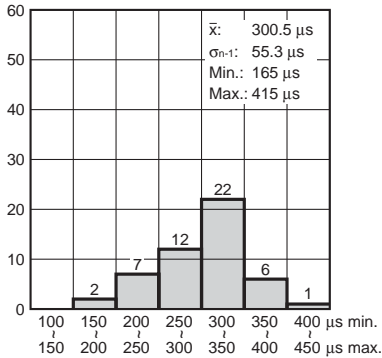

Terminal No. 3-4-5: OFF

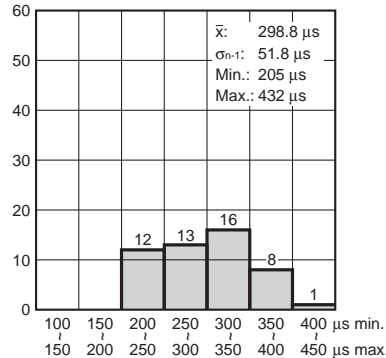

13-(2). Distribution of M.B.B. time
Tested sample: TXD2-2M-5V, 50 pcs.
Terminal No. 8-9-10: ON

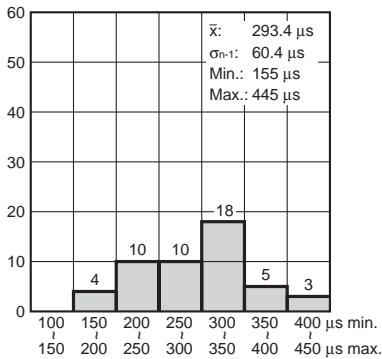

Terminal No. 8-9-10: OFF

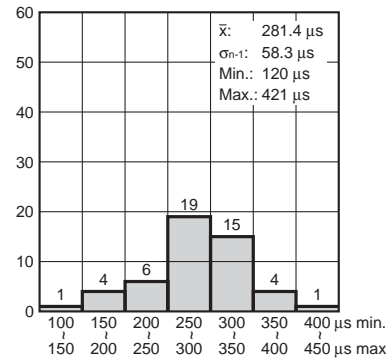

14. ⚠ Surge breakdown voltage test
Tested sample: TXD2-3V-6, 30 pcs.

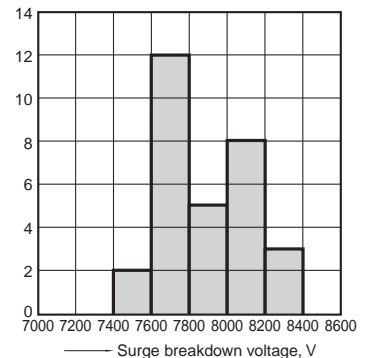

DIMENSIONS (mm inch)

Download [CAD Data](#) from our Web site.

1. Surge breakdown voltage 2,500 V and ⚠ 6,000 V types

1) Standard PC board terminal

[CAD Data](#)

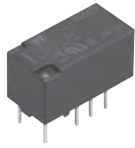

2,500 V type

External dimensions
Standard PC board terminal

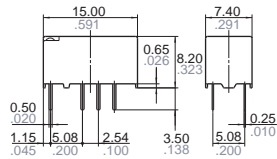

PC board pattern
(Bottom view)

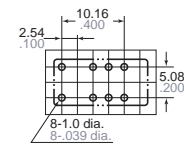

Tolerance: $\pm 0.1 \pm 0.04$

Schematic (Bottom view)

Single side stable

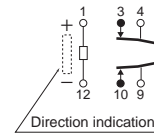

(Deenergized condition)

1 coil latching

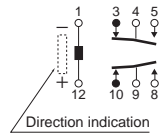

(Reset condition)

[CAD Data](#)

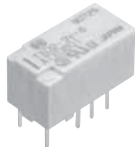

⚠ 6,000 V type

2) Surface-mount terminal

[CAD Data](#)



Type	External dimensions (General tolerance: $\pm 0.3 \pm 0.12$)	Suggested mounting pad (Top view) (Tolerance: $\pm 0.1 \pm 0.04$)
	Single side stable and 1 coil latching	
SA type		
SS type		

Schematic (Top view)

Single side stable

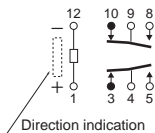

(Deenergized condition)

1 coil latching

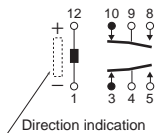

(Reset condition)

2. ⚠ Surge breakdown voltage 6,000 V (High breakdown voltage type)

1) Standard PC board terminal

CAD Data

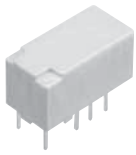

External dimensions
Standard PC board terminal

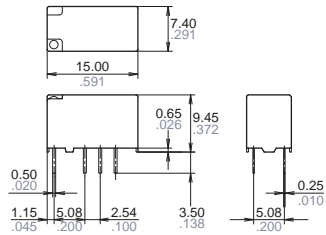

General tolerance: $\pm 0.3 \pm 0.12$

PC board pattern
(Bottom view)

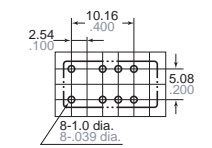

Tolerance: $\pm 0.1 \pm 0.04$

Schematic (Bottom view)
Single side stable 1 coil latching

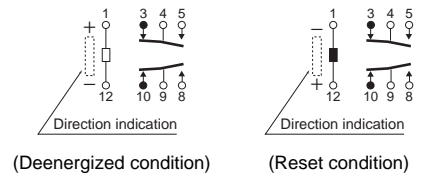

2) Surface-mount terminal

CAD Data



Type	External dimensions (General tolerance: $\pm 0.3 \pm 0.12$)	Suggested mounting pad (Top view) (Tolerance: $\pm 0.1 \pm 0.04$)
	Single side stable and 1 coil latching	Single side stable and 1 coil latching
SA type		
SS type		

Schematic (Top view)

Single side stable

1 coil latching

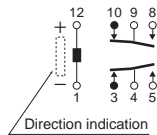
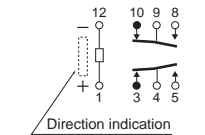

(Deenergized condition)

(Reset condition)

NOTES

1. Packing style

1) Tube packing

The relay is packed in a tube with the relay orientation mark on the left side, as shown in the figure below.

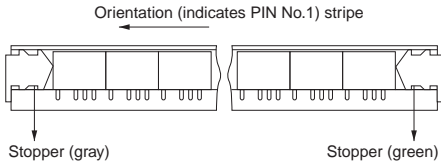

2) Tape and reel packing (surface-mount terminal type)

(1) Tape dimensions

(i) SA type

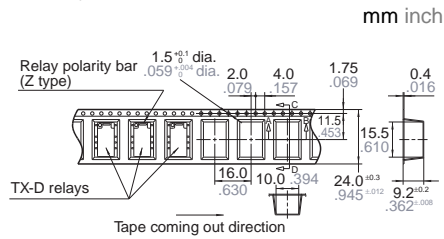

(ii) SS type

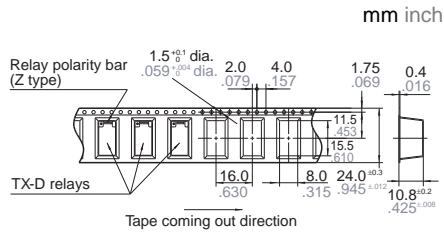

(2) Dimensions of plastic reel

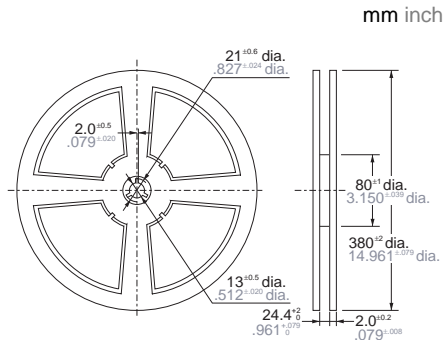

3) Ambient temperature when transporting and during storage with the product in its original packaging:
-40 to +70°C -40 to +158°F

2. Automatic insertion

To maintain the internal function of the relay, the chucking pressure should not exceed the values below.

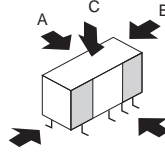

Chucking pressure in the direction A:

4.9 N {500gf} or less

Chucking pressure in the direction B:

9.8 N {1 kgf} or less

Chucking pressure in the direction C:

9.8 N {1 kgf} or less

Please chuck the portion.

Avoid chucking the center of the relay.

In addition, excessive chucking pressure to the pinpoint of the relay should be avoided.

3. M.B.B. type

A small OFF time may be generated by the contact bounce during contact switching. Check the actual circuit carefully.

If the relay is dropped accidentally, check the appearance and characteristics including M.B.B. time before use.

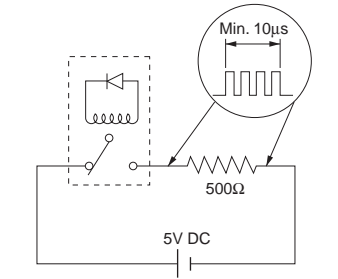



Measuring condition of M.B.B. time

For Cautions for Use, see [Relay Technical Information](#).

Looking for pricing, stock, or lifecycle information?

Click below to explore more details on WIN SOURCE:

-  [View TXD2-12V on WIN SOURCE](#)
-  [Panasonic Information](#)

Optimize Your Supply Chain with WIN SOURCE Solutions

-  Global Sourcing Solution
-  Obsolete Management
-  Cost Control Management
-  Shortage Management
-  Alternative Solution
-  Excess Inventory Management