



**THE DATASHEET OF  
TX1322T**



CTS10EL89

**PECL/ECL Coaxial Cable Driver**

SOIC8

**FEATURES**

- Direct Replacement for ON Semi MC10EL89
- 1.6V Output Swing
- 375ps Propagation Delay
- Internal Input Pull-down Resistors
- RoHS Compliant Pb Free Packages

**BLOCK DIAGRAM**

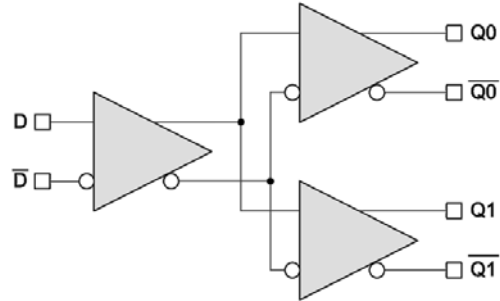

**DESCRIPTION**

The CTS10EL89 is a differential fan-out gate specifically designed to drive coaxial cables. The device is especially useful in digital video applications. In such applications, each output can be used as an independent driver since the system is polarity free.

The driver has a voltage gain of approximately 40 and produces an output swing twice as large as standard ECL output. The driver accepts a standard differential ECL input and can run off of the Digital Video Broadcast standard -5.0V supply.

The CTS10EL89 is a direct replacement for the ON Semi MC10EL89.

**ENGINEERING NOTES**

When driving a coaxial cable, proper termination is required at both ends of the line to minimize signal loss. The 1.6V output swing allows for termination at both ends of the cable, while maintaining the required 800mV swing at the receiving end of the cable. Because of the larger output swings, the device cannot be terminated into the standard  $V_{CC} - 2.0V$ . All of the DC parameters are tested with a  $50\Omega$  to  $V_{CC} - 3.0V$  load. The driver accepts a standard differential ECL input and can run off of the Digital Video Broadcast standard -5.0V supply. Under open input conditions (pulled to  $V_{EE}$ ) internal input clamps will force the Q outputs LOW.

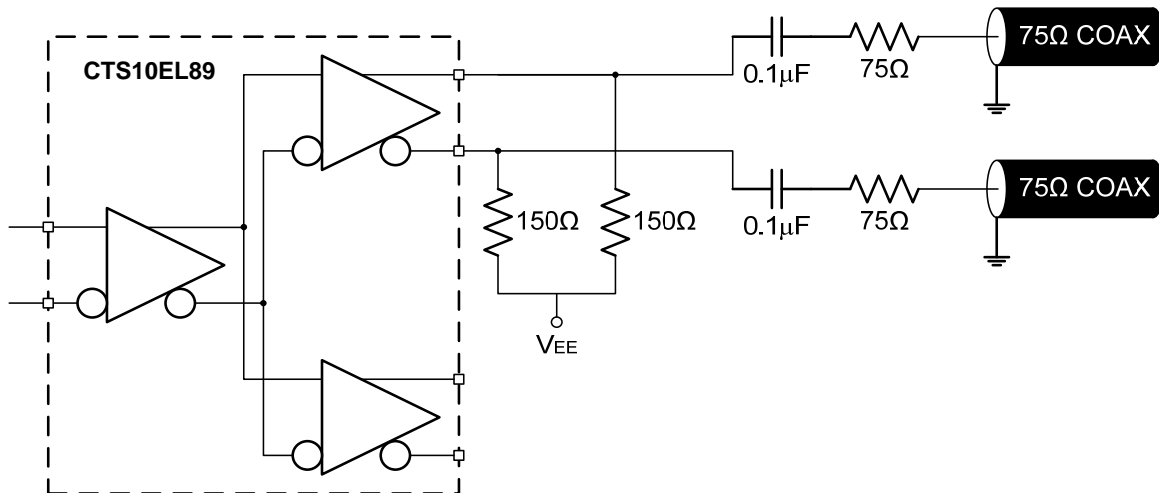

## ELECTRICAL SPECIFICATIONS

### Absolute Maximum Ratings

Absolute Maximum Ratings are those values beyond which device life may be impaired.

Symbol	Characteristic	Condition	Rating	Unit
$V_{CC}$	PECL Power Supply	( $V_{EE} = 0V$ )	0 to +8.0	V
$V_I$	PECL Input Voltage	( $V_{EE} = 0V$ )	0 to +6.0	V
$V_{EE}$	ECL Power Supply	( $V_{CC} = 0V$ )	-8.0 to 0	V
$V_I$	ECL Input Voltage	( $V_{CC} = 0V$ )	-6.0 to 0	V
$I_{OUT}$	Output Current	Continuous	50	mA
		Surge	100	
$T_A$	Operating Temperature Range		-40 to +85	°C
$T_{STG}$	Storage Temperature Range		-65 to +150	°C
$ESD_{HBM}$	Human Body Model		2500	V
$ESD_{MM}$	Machine Model		200	V
$ESD_{CDM}$	Charged Device Model		2500	V

### 10K ECL DC Characteristics ( $V_{EE} = -4.2V$ to $-5.7V$ , $V_{CC} = GND$ )

Symbol	Characteristic	-40 °C			0 °C			25 °C			85 °C			Unit
		Min	Typ	Max	Min	Typ	Max	Min	Typ	Max	Min	Typ	Max	
$V_{OH}$	Output HIGH Voltage <sup>1</sup>	-1230		-980	-1180		-940	-1130		-900	-1060		-810	mV
$V_{OL}$	Output LOW Voltage <sup>1</sup>	-2900		-2580	-2950		-2570	-3000		-2560	-3050		-2510	mV
$V_{IH}$	Input HIGH Voltage	-1230		-890	-1170		-840	-1130		-810	-1060		-720	mV
$V_{IL}$	Input LOW Voltage	-1950		-1500	-1950		-1480	-1950		-1480	-1950		-1445	mV
$I_{IL}$	Input LOW Current	0.5			0.5			0.5			0.5			µA
$I_{IH}$	Input HIGH Current			150			150			150			150	µA
$I_{EE}$	Power Supply Current		23	28		23	28		23	28		23	28	mA

<sup>1</sup> Each output is terminated through a 50Ω resistor to  $V_{CC} - 3V$ .

**10K PECL DC Characteristics ( $V_{EE} = \text{GND}$ ,  $V_{CC} = +5.0\text{V}$ )**

Symbol	Characteristic	-40 °C			0 °C			25 °C			85 °C			Unit
		Min	Typ	Max	Min	Typ	Max	Min	Typ	Max	Min	Typ	Max	
$V_{OH}$	Output HIGH Voltage <sup>1, 2</sup>	3770		4020	3820		4060	3870		4100	3940		4190	mV
$V_{OL}$	Output LOW Voltage <sup>1, 2</sup>	2100		2420	2050		2430	2000		2440	1950		2490	mV
$V_{IH}$	Input HIGH Voltage <sup>1</sup>	3770		4110	3830		4160	3870		4190	3940		4280	mV
$V_{IL}$	Input LOW Voltage <sup>1</sup>	3050		3500	3050		3520	3050		3520	3050		3555	mV
$I_{IL}$	Input LOW Current	0.5			0.5			0.5			0.5			µA
$I_{IH}$	Input HIGH Current			150			150			150			150	µA
$I_{EE}$	Power Supply Current		23	28		23	28		23	28		23	28	mA

<sup>1</sup> For supply voltages other than 5.0V, use the ECL table values and ADD supply voltage value.

<sup>2</sup> Each output is terminated through a 50Ω resistor to  $V_{CC} - 3\text{V}$ .

**AC Characteristics ( $V_{EE} = -4.2\text{V}$  to  $-5.7\text{V}$ ,  $V_{CC} = \text{GND}$  or  $V_{EE} = \text{GND}$ ,  $V_{CC} = +4.2\text{V}$  to  $+5.7\text{V}$ )**

Symbol	Characteristic	-40 °C			0 °C			25 °C			85 °C			Unit
		Min	Typ	Max	Min	Typ	Max	Min	Typ	Max	Min	Typ	Max	
$t_{MAX}$	Maximum Toggle Rate								1.5					Gb/s
$t_{PLH}/t_{PHL}$	Propagation Delay to Output	200	340	480	250	340	430	260	350	440	310	400	490	ps
$t_{SKEW}$	Within-Device Skew <sup>1</sup> Duty Cycle Skew <sup>2</sup>		5	20		5	20		5	20		5	20	ps
$V_{PP}$	Minimum Input Swing <sup>3</sup>	150			150			150			150			mV
$V_{CMR}$	Common Mode Range <sup>4</sup>	$V_{EE} + 2.5$		$V_{CC} - 0.4$	$V_{EE} + 2.5$		$V_{CC} - 0.4$	$V_{EE} + 2.5$		$V_{CC} - 0.4$	$V_{EE} + 2.5$		$V_{CC} - 0.4$	V
$t_R/t_F$	Output Rise/Fall Times Q (20%-80%)	205		455	205		455	205		455	205		455	ps

<sup>1</sup> Within-device skew defined as identical transitions on similar paths through a device.

<sup>2</sup> Duty cycle skew is the difference between a  $t_{PLH}$  and  $t_{PHL}$  propagation delay through a device.

<sup>3</sup>  $V_{PP}$  is the minimum peak-to-peak differential input swing for which AC parameters guaranteed. The device has a DC gain of ~40.

<sup>4</sup> The  $V_{CMR}$  range is referenced to the most positive side of the differential input signal. Normal operation is obtained if the HIGH level falls within the specified range and the peak-to-peak voltage lies between  $V_{PP}$  (min) and 1V.

### Pin Description and Configuration

#### Pin Assignments

Pin	Name	Type	Function
1	$Q_0$	Output	Data Output (1.6V <sub>PP</sub> )
2	$\Sigma\bar{Q}_0$	Output	Data Output (1.6V <sub>PP</sub> )
3	$Q_1$	Output	Data Output (1.6V <sub>PP</sub> )
4	$\Sigma\bar{Q}_1$	Output	Data Output (1.6V <sub>PP</sub> )
5	$V_{EE}$	Power	Negative Supply
6	$\Sigma\bar{D}$	Input	Data Input
7	D	Input	Data Input
8	$V_{CC}$	Power	Positive Supply

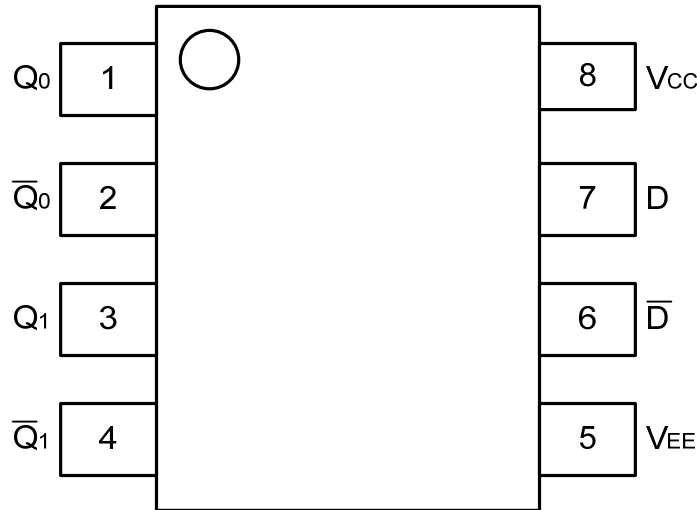

CTS10EL89

PECL/ECL Coaxial Cable Driver

SOIC8

### PACKAGE DIMENSIONS

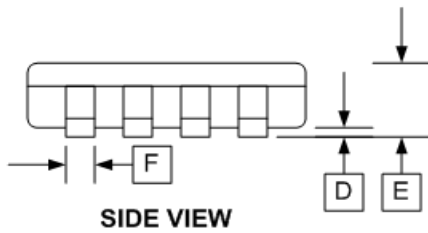
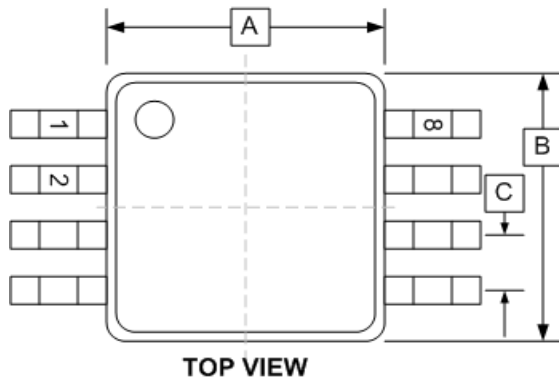

DIM	mm	
	MIN	MAX
A	3.81	3.99
B	4.80	4.98
C	1.27 BSC	
D	0.10	0.25
E	1.37	1.68
F	0.36	0.48
G	0.25	
H	0.19	0.25
I	0.41	0.86

SOIC8 (D)

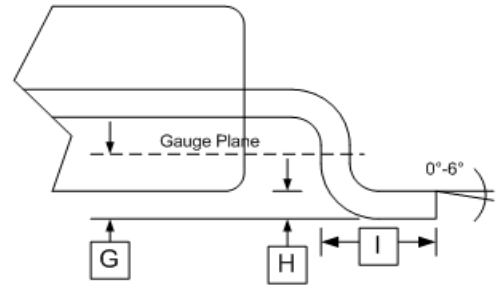

### PCB LAND PATTERN/FOOTPRINT

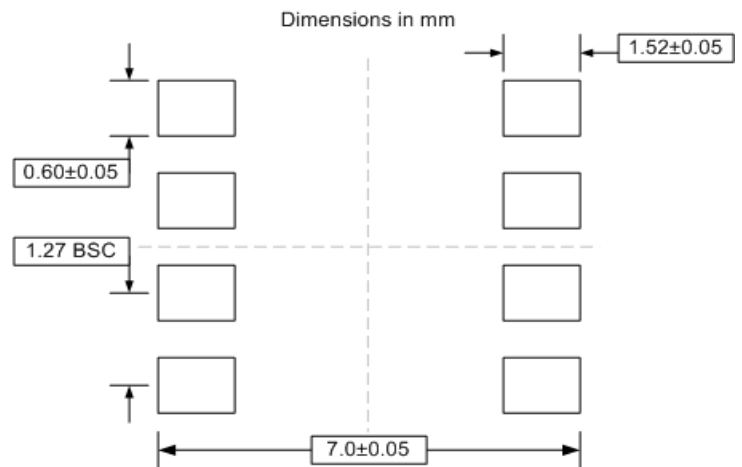

### PART ORDERING INFORMATION

Part Number	Package	Marking
CTS10EL89DG	SOIC8	CTS10 / EL89 / YYWW

## Looking for pricing, stock, or lifecycle information?

Click below to explore more details on WIN SOURCE:

 [View TX1322T on WIN SOURCE](#)

 [Pulse Information](#)

## Optimize Your Supply Chain with WIN SOURCE Solutions

-  Global Sourcing Solution
-  Obsolete Management
-  Cost Control Management
-  Shortage Management
-  Alternative Solution
-  Excess Inventory Management