

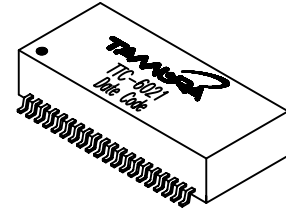

T1/E1/PRI-ISDN/CEPT Magnetic Module, Multi Port, 40 pin SMD

MODEL NUMBER
TTC-6021

- Surface Mount Device withstands IR reflow profile process
- Operating temperature: -40°C to +85°C



Electrical Specification from 0°C to +70°C						@ -40°C
DCR (ΩMax)	Crosstalk (dB Min)	OCL (mH Min)	Hipot (Vrms)	Leakage Inductance (μH Max)	Cww (pF Max)	OCL (mH Min)
Primary	0.1-10 MHz	Primary 100KHz 0.1Vrms	60 sec	100KHz 0.1Vrms	100KHz 0.1Vrms	Primary 100KHz 0.1Vrms
0.8	-35	1.2	1500	0.5	35	0.6

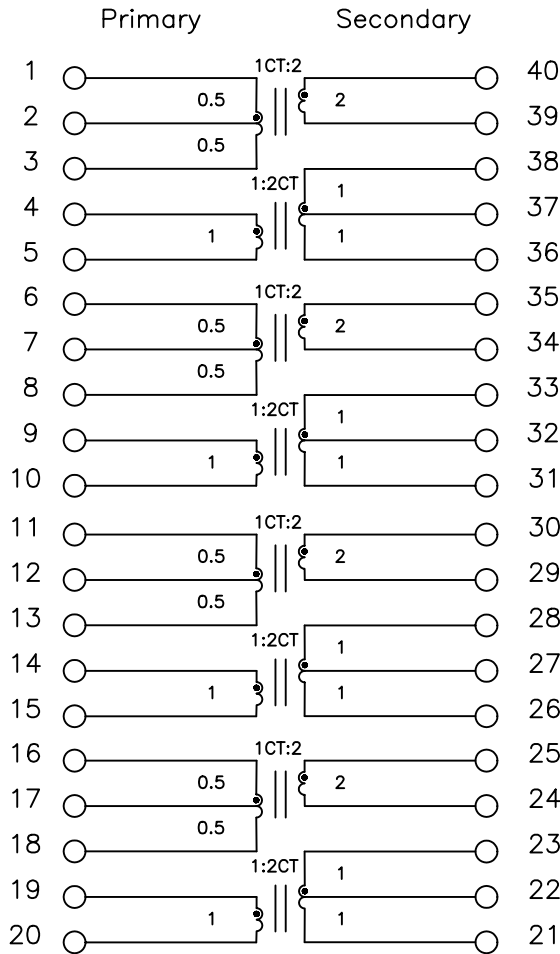

PREPARED BY:

D. Rund

ENGINEER:

L. Le

QUALITY CONTROL:

T. Clem

APPROVED:

J. Coleman

DWG CONTROL NO.
P-A1-12874
ACAD\TTC\A1128741.DWG

REV
-

T1/E1/PRI-ISDN/CEPT MAGNETIC MODULE
MULTI PORT, 40 PIN SMD

TAMURA CORPORATION OF AMERICA
43352 BUSINESS PARK DRIVE, TEMECULA, CA. 92590-6624
(909) 699-1270 FAX 9096769482

TTC-6021

MODEL SPECIFICATION

DIM: MM[IN] | SCL: NONE | SH: 1 OF 2

PROPRIETARY NOTICE: THIS DRAWING PRINT OR DOCUMENT AND SUBJECT MATTER DISCLOSED HEREIN ARE PROPRIETARY ITEMS TO WHICH TAMURA RETAINS THE EXCLUSIVE RIGHT OF DISSEMINATION, REPRODUCTION, MANUFACTURE AND SALE. THIS DRAWING, PRINT OR DOCUMENT IS SUBMITTED IN CONFIDENCE FOR CONSIDERATION BY THE RECIPIENT ALONE UNLESS PERMISSION FOR FURTHER DISCLOSURE IS EXPRESSLY GRANTED IN WRITING.



T1/E1/PRI-ISDN/CEPT Magnetic
Module, Multi Port, 40 pin SMD

MODEL NUMBER
TTC-6021

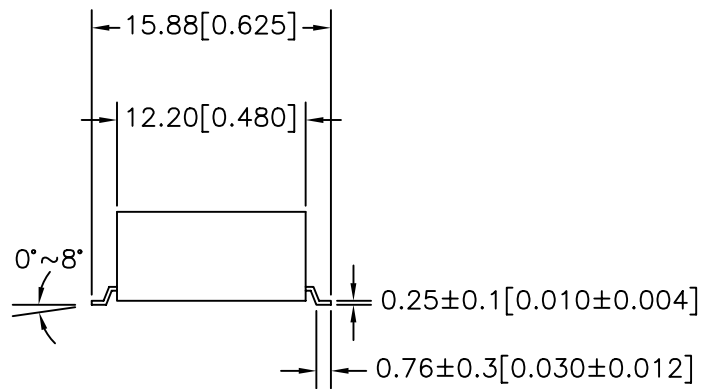
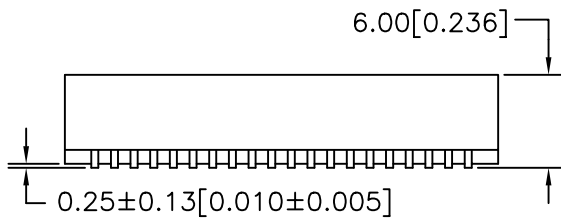
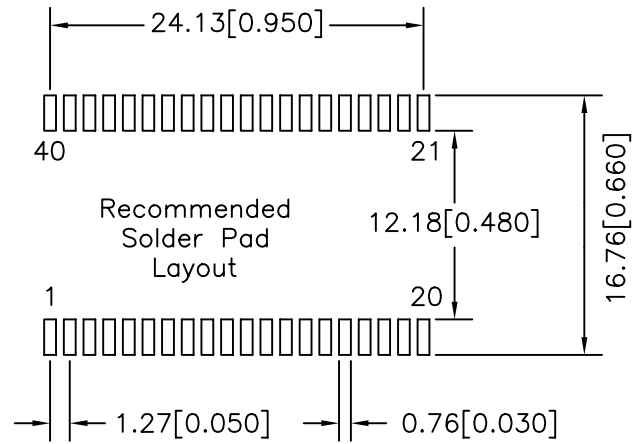
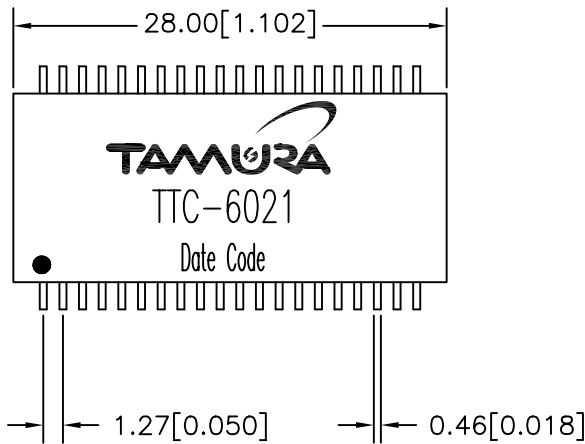
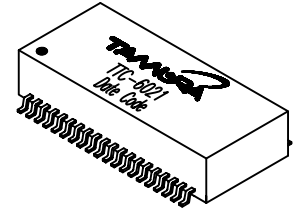

PREPARED BY:

D. Rund

ENGINEER:

L. Le

QUALITY CONTROL:

T. Clem

APPROVED:

J. Coleman

NOTE: Unless otherwise specified, all dimensions are mm[in] with tolerance of ±0.25[0.010]

DWG CONTROL NO. P-A1-12874 ACAD\TTC\A1128742.DWG	REV -	T1/E1/PRI-ISDN/CEPT MAGNETIC MODULE MULTI PORT, 40 PIN SMD
--------------------------------------------------------	----------	---------------------------------------------------------------

TTC-6021

MODEL SPECIFICATION

TAMURA CORPORATION OF AMERICA 43352 BUSINESS PARK DRIVE, TEMECULA, CA. 92590-6624 (909) 699-1270 FAX 9096769482		
------------------------------------------------------------------------------------------------------------------------------	--	--

DIM: MM[IN]	SCL: NONE	SH: 2 OF 2
-------------	-----------	------------

PROPRIETARY NOTICE: THIS DRAWING PRINT OR DOCUMENT AND SUBJECT MATTER DISCLOSED HEREIN ARE PROPRIETARY ITEMS TO WHICH TAMURA RETAINS THE EXCLUSIVE RIGHT OF DISSEMINATION, REPRODUCTION, MANUFACTURE AND SALE. THIS DRAWING, PRINT OR DOCUMENT IS SUBMITTED IN CONFIDENCE FOR CONSIDERATION BY THE RECIPIENT ALONE UNLESS PERMISSION FOR FURTHER DISCLOSURE IS EXPRESSLY GRANTED IN WRITING.

Looking for pricing, stock, or lifecycle information?

Click below to explore more details on WIN SOURCE:

 [View TTC-6021 on WIN SOURCE](#)

 [Tamura Information](#)

Optimize Your Supply Chain with WIN SOURCE Solutions

-  Global Sourcing Solution
-  Obsolete Management
-  Cost Control Management
-  Shortage Management
-  Alternative Solution
-  Excess Inventory Management