



**THE DATASHEET OF
TPS65132AYFFR**



TPS65132 Single Inductor - Dual Output Power Supply

1 Features

- Input Voltage Range: 2.5 V to 5.5 V
- V_{POS} Boost Converter: 4 V to 6 V (0.1-V step)
- V_{NEG} Inverting Buck-Boost Converter: -6 V to -4 V (0.1-V step)
- Maximum Output Current: 80 mA or 150 mA
- Outstanding Combined Efficiency
 - > 85% at $I_{OUT} > 10$ mA
 - > 90% at $I_{OUT} > 40$ mA
- Excellent Performance
 - Outstanding Transient Response
 - 1% Output Voltage Accuracy over Full Temperature Range
- I²C Interface
 - Programmable Power-Up / -Down Sequencing Options
 - Flexible Output Voltage Programming
 - Programmable Active Output Discharge
 - > 1000x Programmable Non-Volatile Memory
- Under-Voltage Lock-Out and Thermal Protection
- Two Package Options
 - 15-Ball CSP Package
 - 20-Pins QFN Package

2 Applications

- Small-, Medium-Size Bipolar LCD Displays
 - Smartphone, Tablet
 - Camera, GPS
 - Home Automation, Point-of-Sales
 - Wearables (Smart Watch, Activity Tracker)
- General Split-Rail Power Supply
 - Differential Audio, Headphone Amplifier
 - Instrumentation, Operational Amplifier, Comparator
 - DAC / ADC

3 Description

The TPS65132 family is designed to supply positive/negative driven applications. The device uses a single inductor scheme for both outputs to provide the user smallest solution size, a small bill-of-material as well as high efficiency. The devices offer best line and load regulation at low noise. With its input voltage range of 2.5 V to 5.5 V, it is optimized for products powered by single-cell batteries (Li-Ion, Ni-Li, Li-Polymer) and fixed 3.3-V and 5-V rails. The TPS65132 family provides 80 mA and 150 mA output current options with programmability to 40 mA. There are both CSP and QFN package options available.

Device Information ⁽¹⁾

PART NUMBER	PACKAGE	BODY SIZE (NOM.)
TPS65132-B, -L, -T, -S	DSBGA (15)	2.11 mm × 1.51 mm
TPS65132W	WQFN (20)	4.00 mm × 3.00 mm

(1) For all available packages, see the orderable addendum at the end of the datasheet.

Typical Application

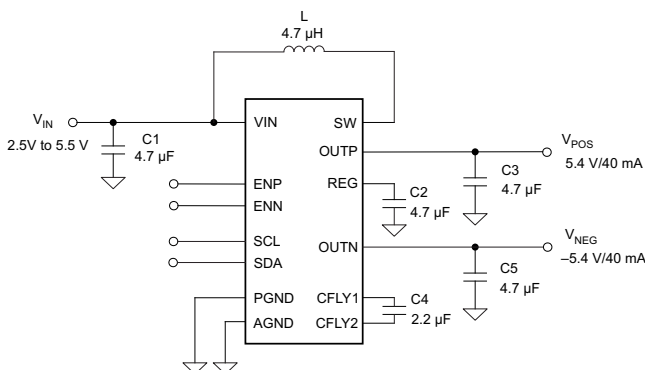

Efficiency vs Output Current

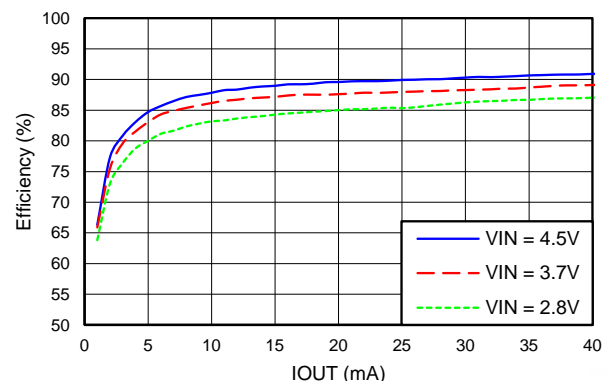

Table of Contents

1 Features	1	8.5 Programming.....	17
2 Applications	1	8.6 Register Maps	19
3 Description	1	9 Application and Implementation	26
4 Revision History	2	9.1 Application Information.....	26
5 Device Comparison Table	4	9.2 Typical Applications	26
6 Pin Configuration and Functions	5	10 Power Supply Recommendations	53
7 Specifications	8	11 Layout	54
7.1 Absolute Maximum Ratings	8	11.1 Layout Guidelines	54
7.2 ESD Ratings.....	8	11.2 Layout Example	54
7.3 Recommended Operating Conditions.....	8	12 Device and Documentation Support	55
7.4 Thermal Information	8	12.1 Device Support.....	55
7.5 Electrical Characteristics.....	9	12.2 Receiving Notification of Documentation Updates	55
7.6 I ² C Interface Timing Requirements / Characteristics	10	12.3 Community Resources.....	55
7.7 Typical Characteristics.....	11	12.4 Trademarks	55
8 Detailed Description	12	12.5 Electrostatic Discharge Caution.....	55
8.1 Overview	12	12.6 Glossary	55
8.2 Functional Block Diagram	12	13 Mechanical, Packaging, and Orderable	
8.3 Feature Description.....	12	Information	55
8.4 Device Functional Modes.....	16	13.1 CSP Package Summary	56

4 Revision History

NOTE: Page numbers for previous revisions may differ from page numbers in the current version.

Changes from Revision G (August 2015) to Revision H	Page
• Removed Product Preview from TPS65132S.	1
• Changed Device Comparison Table	4
• Added description of clock stretching	17
• Deleted detailed I ² C interface description	17
• Added that the DLYx Register is only valid for TPS65132Sx versions.	22
• Changed Table 6	23

Changes from Revision F (June 2015) to Revision G	Page
• Changed scope figures for Boost Converter switching.	13

Changes from Revision E (November 2014) to Revision F	Page
• Added TPS65132L1 device to Device Comparison table	4
• Added TPS65132T6 device to the Device Comparison Table.	4
• Separated LOGIC SCL, SDA spec MIN/MAX from LOGIC EN, ENN, ENP, SYNC spec MIN/MAX	9
• Changed DAC Registers section for clarity	19
• Added High-current Applications (≤ 150 mA) section.....	44

Changes from Revision D (October 2014) to Revision E	Page
• Added TPS65132L0 device to Device Comparison table	4

Changes from Revision C (July 2014) to Revision D **Page**

- Changed package type to industry standard identifier in the Device Information table 1

Changes from Revision B (May 2014) to Revision C **Page**

- Added note to Device Comparison Table 4
- Added reference to [Power-Down And Discharge \(LDO\)](#) and [Power-Down And Discharge \(CPN\)](#) 12
- Added [Table 1](#) and various references to it 14
- Added "[Power-Down And Discharge \(CPN\)](#) shows the V_{NEG} discharge behavior of each device variant"..... 16
- Added [Table 2](#) and various references to it 16
- Added note to [Figure 18](#) 23

Changes from Revision A (August 2013) to Revision B **Page**

- Formatted to the new data sheet standard 1
- Added new package option (QFN) to Device Information table 1
- Added new package option (QFN) to Pin Configurations section 7
- Added the ESD Ratings table 8

Changes from Original (June 2013) to Revision A **Page**

- Added TPS65132Bx devices to the Device Comparison table 4

5 Device Comparison Table

PART NUMBER ⁽¹⁾	PRE-PROGRAMMED OUTPUT VOLTAGES	I _{OUT_MAX}	PRE-PROGRAMMED I _{OUT}	PRE-PROGRAMMED ACTIVE DISCHARGE ⁽²⁾	STARTUP TIME V _{POS} / V _{NEG} ⁽³⁾	I _{SD}	PACKAGE
TPS65132A	V _{POS} = 5.4 V V _{NEG} = -5.4 V	80 mA	40 mA	V _{POS} / V _{NEG}	FAST	30 μA	CSP
TPS65132A0	V _{POS} = 5.0 V V _{NEG} = -5.0 V						
TPS65132B	V _{POS} = 5.4 V V _{NEG} = -5.4 V	80 mA	40 mA	V _{POS} / V _{NEG}	FAST	130 nA	CSP
TPS65132B0	V _{POS} = 5.0 V V _{NEG} = -5.0 V						
TPS65132B5	V _{POS} = 5.5 V V _{NEG} = -5.5 V						
TPS65132B2	V _{POS} = 5.2 V V _{NEG} = -5.2 V	80 mA	40 mA	V _{POS} / V _{NEG}	SLOW	130 nA	CSP
TPS65132L	V _{POS} = 5.4 V V _{NEG} = -5.4 V						
TPS65132L0	V _{POS} = 5.0 V V _{NEG} = -5.0 V						
TPS65132L1 ⁽⁴⁾	V _{POS} = 5.1 V V _{NEG} = -5.1 V	80 mA	40 mA	V _{POS} / V _{NEG}	SLOW	130 nA	CSP
TPS65132T6	V _{POS} = 5.6 V V _{NEG} = -5.6 V	80 mA	80 mA	V _{POS} / V _{NEG}	SLOW	130 nA	CSP
TPS65132S	V _{POS} = 5.4 V V _{NEG} = -5.4 V	150 mA	80 mA	V _{POS} / V _{NEG}	SLOW	130 nA	CSP
TPS65132W	V _{POS} = 5.4 V V _{NEG} = -5.4 V	80 mA	80 mA	V _{POS} / V _{NEG}	SLOW	130 nA	QFN

- (1) For the most current package and ordering information, see the Package Option Addendum at the end of this document, or see the TI website at www.ti.com
- (2) See [Power-Down And Discharge \(LDO\)](#) and [Power-Down And Discharge \(CPN\)](#) for a detailed description of how each device variant implements the active discharge function.
- (3) Please refer to [Power-Up And Soft-Start \(LDO\)](#) and [Power-Up And Soft-Start \(CPN\)](#) for more details.
- (4) Product preview.

6 Pin Configuration and Functions

YFF Package 15 Bumps

(top view)
TPS65132Ax / Bx / Lx / Tx

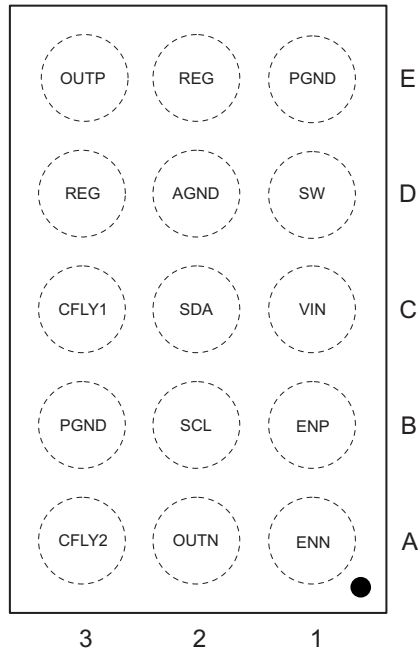

(bottom view)
TPS65132Ax / Bx / Lx / Tx

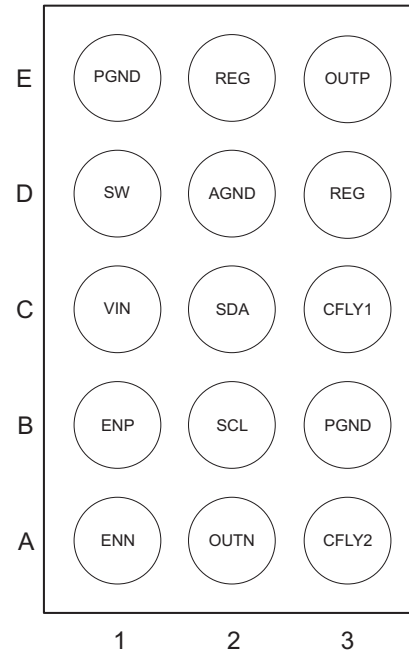

(top view)
TPS65132Sx

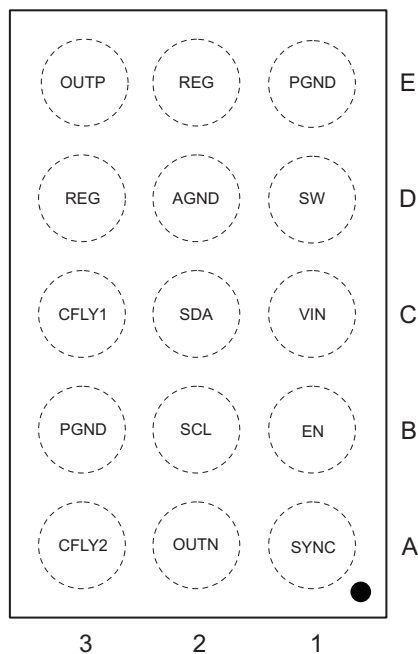

(bottom view)
TPS65132Sx

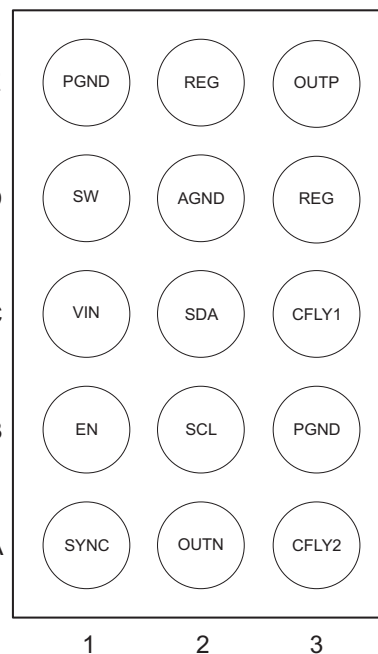

Pin Functions

PIN			I/O	DESCRIPTION
NAME	Ax, Bx, Lx, Tx	Sx		
AGND	D2	D2	—	Analog ground
CFLY1	C3	C3	I/O	Negative charge pump flying capacitor pin
CFLY2	A3	A3	I/O	Negative charge pump flying capacitor pin
EN	—	B1		Enable pin (sequence programmed)
ENN	A1	—	I	Enable pin for V_{NEG} rail
ENP	B1	B1	I	Enable pin for V_{POS} rail
OUTP	E3	E3	O	Output pin of the LDO (V_{POS})
OUTN	A2	A2	O	Output pin of the negative charge pump (V_{NEG})
PGND	B3	B3	—	Power ground
	E1	E1		
REG	D3	D3	I/O	Boost converter output pin
	E2	E2		
SCL	B2	B2	I/O	I ² C interface clock signal pin
SDA	C2	C2	I/O	I ² C interface data signal pin
SW	D1	D1	I/O	Switch pin of the boost converter
SYNC	—	A1	I	Synchronization pin. 150 mA current enabled if this pin is pulled HIGH.
VIN	C1	C1	I	Input voltage supply pin

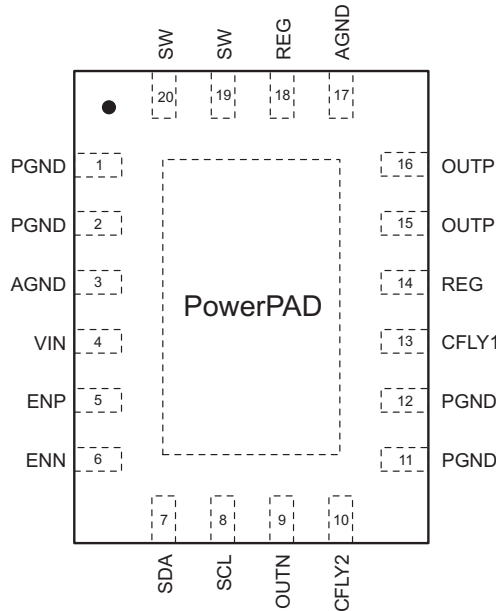
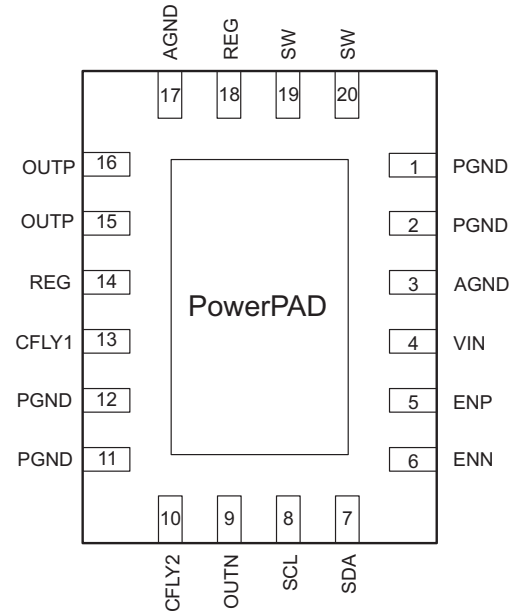
**QFN Package
20 Pins**
**RVC package
(top view)**

**RVC package
(bottom view)**

Pin Functions

PIN		I/O	DESCRIPTION
NAME	Wx		
AGND	3	—	Analog ground
	17		
CFLY1	13	I/O	Negative charge pump flying capacitor pin
CFLY2	10	I/O	Negative charge pump flying capacitor pin
ENN	6	I	Enable pin for V_{NEG} rail
ENP	5	I	Enable pin for V_{POS} rail
OUTP	16	O	Output pin of the LDO (V_{POS})
	15		
OUTN	9	O	Output pin of the negative charge pump (V_{NEG})
PGND	1	—	Power ground
	2		
	11		
	12		
REG	14	I/O	Boost converter output pin
	18		
SCL	8	I/O	I ² C interface clock signal pin
SDA	7	I/O	I ² C interface data signal pin
SW	19	I/O	Switch pin of the boost converter
	20		
VIN	4	I	Input voltage supply pin

7 Specifications

7.1 Absolute Maximum Ratings⁽¹⁾⁽²⁾

over operating free-air temperature range (unless otherwise noted)

		VALUE		UNIT
		MIN	MAX	
Voltage range	CFLY1, EN, ENN, ENP, OUTP, REG, SCL, SDA, SW, SYNC, VIN	-0.3	7	V
	CFLY2, OUTN	-7	0.3	V
Continuous total power dissipation		See Thermal Information		
Operating junction temperature, T _J		-40	150	°C
Operating ambient temperature, T _A		-40	85	°C
Storage temperature, T _{stg}		-65	150	°C

- (1) Stresses beyond those listed under *absolute maximum ratings* may cause permanent damage to the device. These are stress ratings only, and functional operation of the device at these or any other conditions beyond those indicated under *recommended operating conditions* is not implied. Exposure to absolute-maximum-rated conditions for extended periods may affect device reliability.
- (2) All voltage values are with respect to ground.

7.2 ESD Ratings

		VALUE	UNIT
V _{ESD}	Human body model (HBM), per ANSI/ESDA/JEDEC JS-001, all pins ⁽¹⁾	±2000	V
	Charged device model (CDM) per JEDEC specification JESD22-C101, all pins ⁽²⁾	±500	V

- (1) JEDEC document JEP155 states that 500-V HBM allows safe manufacturing with a standard ESD control process.
- (2) JEDEC document JEP157 states that 250-V CDM allows safe manufacturing with a standard ESD control process.

7.3 Recommended Operating Conditions

		MIN	TYP	MAX	UNIT
V _{IN}	Input voltage range	2.5		5.5	V
L	Inductor ⁽¹⁾	2.2		4.7	μH
C _{IN}	Input capacitor ⁽¹⁾⁽²⁾	4.7			μF
C _{FLY}	Flying capacitor ⁽¹⁾⁽²⁾	2.2			μF
C _{OUTP} , C _{OUTN} , C _{REG}	Output capacitors ⁽¹⁾⁽²⁾	4.7			μF
T _A	Operating ambient temperature	-40		85	°C
T _J	Operating junction temperature	-40		125	°C

- (1) Please see [Detailed Description](#) section for further information.
- (2) X7R (or better dielectric material) is recommended.

7.4 Thermal Information

THERMAL METRIC ⁽¹⁾		TPS65132	TPS65132	UNIT
		YFF	RVC	
		(15) BALLS	(20) PINS	
R _{θJA}	Junction-to-ambient thermal resistance	76.5	39.0	°C/W
R _{θJctop}	Junction-to-case (top) thermal resistance	0.2	42.7	°C/W
R _{θJB}	Junction-to-board thermal resistance	44	13.6	°C/W
ψ _{JT}	Junction-to-top characterization parameter	1.6	0.6	°C/W
ψ _{JB}	Junction-to-board characterization parameter	43.4	13.6	°C/W
R _{θJcbot}	Junction-to-case (bottom) thermal resistance	N/A	3.8	°C/W

- (1) For more information about traditional and new thermal metrics, see the *Semiconductor and IC Package Thermal Metrics* application report, [SPRA953](#).

7.5 Electrical Characteristics

$V_{IN} = 3.7\text{ V}$, $EN = ENN = ENP = V_{IN}$, $V_{POS} = 5.4\text{ V}$, $V_{NEG} = -5.4\text{ V}$, $T_A = -40^\circ\text{C}$ to 85°C ; typical values are at $T_A = 25^\circ\text{C}$ (unless otherwise noted).

PARAMETER		TEST CONDITIONS	MIN	TYP	MAX	UNIT
SUPPLY CURRENT						
V_{IN}	Input voltage range		2.5		5.5	V
V_{UVLO}	Undervoltage lockout threshold	V_{IN} rising	2.3		2.5	V
		V_{IN} falling	2.1		2.3	
I_Q	Quiescent current			0.54		mA
	Thermal shutdown			140		$^\circ\text{C}$
	Thermal shutdown hysteresis			5		$^\circ\text{C}$
LOGIC EN, ENN, ENP, SYNC						
V_{IH}	High level input voltage	$V_{IN} = 2.5\text{ V to }5.5\text{ V}$	1.1			V
V_{IL}	Low level input voltage				0.4	
R_{EN}	Pulldown resistors		200			k Ω
LOGIC SCL, SDA						
V_{IH}	High level input voltage	$V_{IN} = 2.5\text{ V to }5.5\text{ V}$	1.1			V
V_{IL}	Low level input voltage				0.54	
BOOST CONVERTER						
I_{LIM}	Boost converter valley current limit		0.9	1.2	1.5	A
f_{SW}	Boost converter switching frequency		1.35	1.80	2.25	MHz
LDO OUTPUT V_{POS}						
V_{POS}	Positive output voltage range		4.0		6.0	V
V_{POS_acc}	Positive output voltage accuracy		-1 %		+1 %	
I_{POS}	Positive output current capability		200			mA
V_{DO}	Dropout voltage	$V_{REG} = V_{POS(NOM)} = 5.4\text{ V}$, $I_{OUT} = 150\text{ mA}$	160			mV
	Line regulation	$V_{IN} = 2.5\text{ V to }5.5\text{ V}$, $I_{OUT} = 40\text{ mA}$	2.7			mV
	Load regulation	$\Delta I_{OUT} = 80\text{ mA}$	3.4			%/A
R_D	Discharge resistor		70			Ω
NEGATIVE CHARGE PUMP OUTPUT V_{NEG}						
V_{NEG}	Negative output voltage range		-6.0		-4.0	V
V_{NEG_acc}	Negative output voltage accuracy		-1 %		+1 %	
I_{NEG}	Negative output current capability	40mA MODE	40			mA
		80mA MODE	80			
I_{NEG}	Negative output current capability	TPS65132Sx, SYNC = HIGH	150			mA
f_{OSC}	Negative charge pump switching frequency		0.8	1.0	1.2	MHz
	Line regulation	$V_{IN} = 2.5\text{ V to }5.5\text{ V}$, $I_{OUT} = 40\text{ mA}$	3.3			mV
	Load regulation	$\Delta I_{OUT} = 80\text{ mA}$	6.1			%/A
R_D	Discharge resistor		20			Ω

7.6 I²C Interface Timing Requirements / Characteristics ⁽¹⁾

PARAMETER		TEST CONDITIONS	MIN	TYP	MAX	UNIT
f _{SCL}	SCL clock frequency	Standard mode			100	kHz
		Fast mode			400	kHz
t _{LOW}	LOW period of the SCL clock	Standard mode	4.7			μs
		Fast mode	1.3			μs
t _{HIGH}	HIGH period of the SCL clock	Standard mode	4.0			μs
		Fast mode	600			ns
t _{BUF}	Bus free time between a STOP and START condition	Standard mode	4.7			μs
		Fast mode	1.3			μs
t _{hd;STA}	Hold time for a repeated START condition	Standard mode	4.0			μs
		Fast mode	600			ns
t _{su;STA}	Setup time for a repeated START condition	Standard mode	4.7			μs
		Fast mode	600			ns
t _{su;DAT}	Data setup time	Standard mode	250			ns
		Fast mode	100			ns
t _{hd;DAT}	Data hold time	Standard mode	0.05	3.45		μs
		Fast mode	0.05	0.9		μs
t _{RCL1}	Rise time of SCL signal after a repeated START condition and after an acknowledge bit	Standard mode	20 + 0.1C _B		1000	ns
		Fast mode	20 + 0.1C _B		1000	ns
t _{RCL}	Rise time of SCL signal	Standard mode	20 + 0.1C _B		1000	ns
		Fast mode	20 + 0.1C _B		300	ns
t _{FCL}	Fall time of SCL signal	Standard mode	20 + 0.1C _B		300	ns
		Fast mode	20 + 0.1C _B		300	ns
t _{RDA}	Rise time of SDA signal	Standard mode	20 + 0.1C _B		1000	ns
		Fast mode	20 + 0.1C _B		300	ns
t _{FDA}	Fall time of SDA signal	Standard mode	20 + 0.1C _B		300	ns
		Fast mode	20 + 0.1C _B		300	ns
t _{su;STO}	Setup time for STOP condition	Standard mode	4.0			μs
		Fast mode	600			ns
C _B	Capacitive load for SDA and SCL				0.4	nF

(1) Industry standard I²C timing characteristics according to I²C-Bus Specification, Version 2.1, January 2000. Not tested in production.

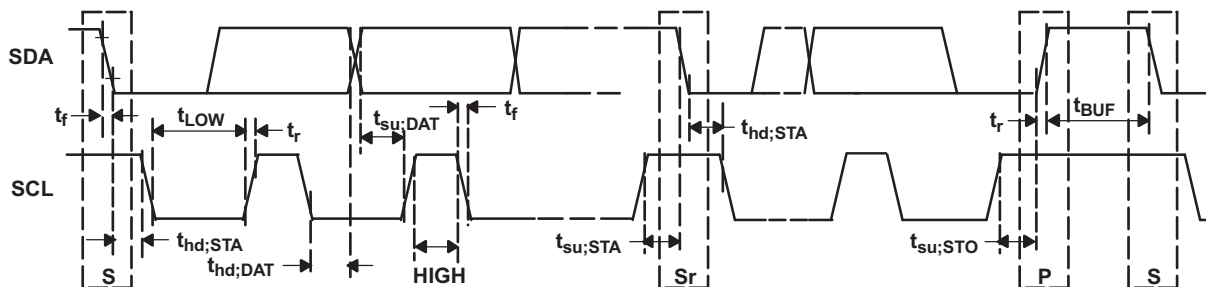

Figure 1. Serial Interface Timing For F/S-Mode

7.7 Typical Characteristics

$V_{IN} = 3.7\text{ V}$, $V_{POS} = 5.4\text{ V}$, $V_{NEG} = -5.4\text{ V}$, unless otherwise noted

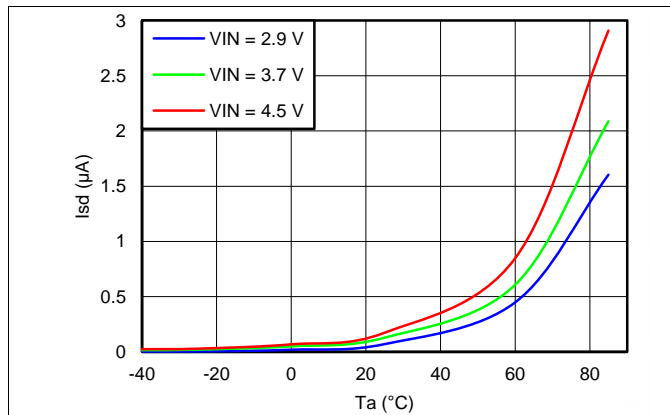

Figure 2. Shutdown Current (all versions but Ax)

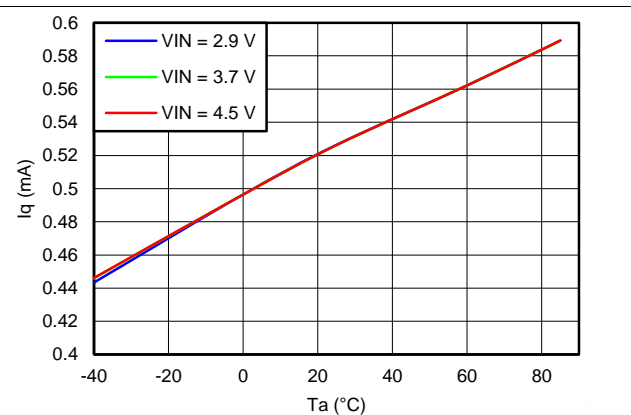

Figure 3. Quiescent Current

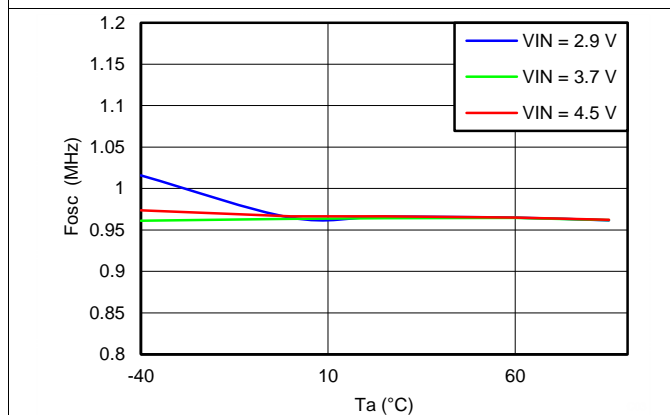

Figure 4. Main Oscillator Frequency

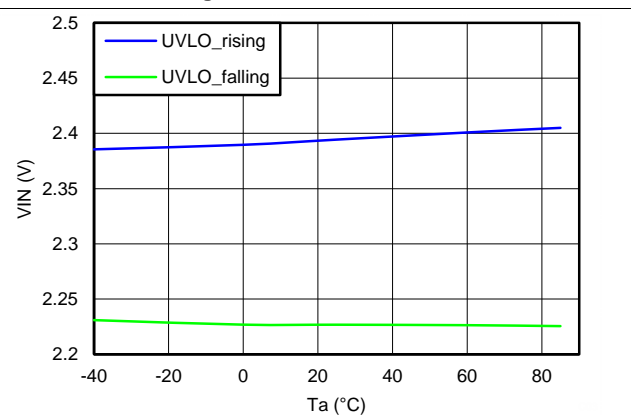

Figure 5. UVLO

8 Detailed Description

8.1 Overview

The TPS65132, supporting input voltage range from 2.5 V to 5.5 V, operates with a single inductor scheme to provide a high efficiency with a small solution size. The synchronous boost converter generates a positive voltage that is regulated down by an integrated LDO, providing the positive supply rail (V_{POS}). The negative supply rail (V_{NEG}) is generated by an integrated negative charge pump (or CPN) driven from the boost converter output pin, REG. The operating mode can be selected between 40mA and 80mA in order to select the necessary output current capability and to get the best efficiency possible based on the application. The device topology allows a 100% asymmetry of the output currents.

8.2 Functional Block Diagram

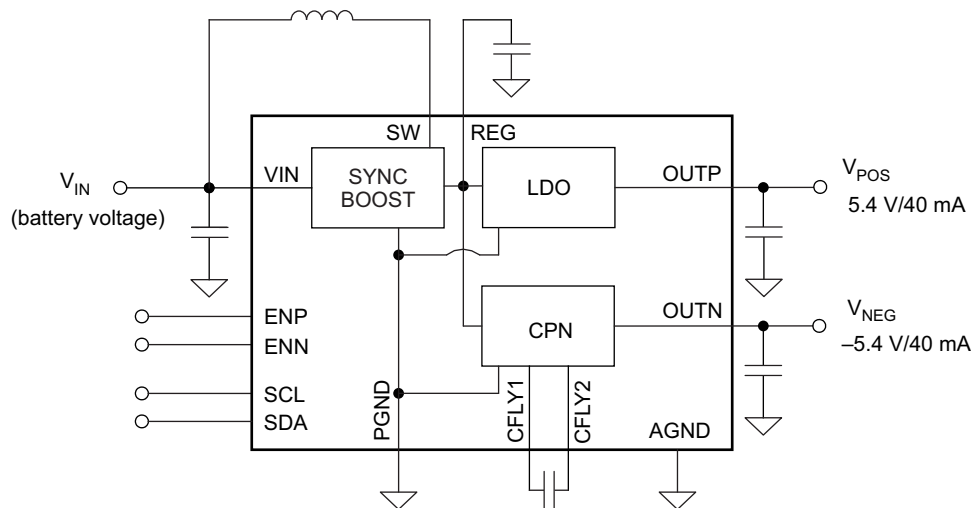

8.3 Feature Description

8.3.1 Undervoltage Lockout (UVLO)

The TPS65132 integrates an undervoltage lockout block (UVLO) that enables the device once the voltage on the VIN pin exceeds the UVLO threshold (2.5 V maximum). No output voltage will be generated as long as the enable signals are not pulled HIGH. The device, as well as all converters (boost converter, LDO, CPN), will be disabled as soon as the V_{IN} voltage falls below the UVLO threshold. The UVLO threshold is designed in a way that the TPS65132 will continue operating as long as V_{IN} stays above 2.3 V. This guarantees a proper operation even in the event of extensive line transients when the battery gets suddenly heavily loaded.

For TPS65132Ax, a 40 ms delay is starting as soon as the UVLO threshold is reached. This delay prevents the device to be disabled and enabled by an unwanted VIN voltage spike. Once this delay has passed, the output rails can be enabled and disabled as desired with the enable signals without any delay.

8.3.2 Active Discharge

An active discharge of the positive rail and/or the negative rail can be programmed (DISP and DISN bits respectively - refer to [Registers](#)). If programmed to be active, the discharge will occur at power down, when the enable signals go LOW ([Figure 37](#) and [Figure 38](#) for TPS65132Ax, Bx, Lx, Tx, Wx — [Figure 105](#) and [Figure 104](#) for TPS65132Sx). See [Power-Down And Discharge \(LDO\)](#) and [Power-Down And Discharge \(CPN\)](#) for a detailed description of how each device variant implements the active discharge function.

Feature Description (continued)

8.3.3 Boost Converter

8.3.3.1 Boost Converter Operation

The synchronous boost converter uses a current mode topology and operates at a quasi-fixed frequency of typically 1.8 MHz, allowing chip inductors such as 2.2 μH or 4.7 μH to be used. The converter is internally compensated and provides a regulated output voltage automatically adjusted depending on the programmed V_{POS} and V_{NEG} voltages. The boost converter operates either in continuous conduction mode (CCM) or Pulse Frequency Modulation mode (PFM), depending on the load current in order to provide the highest efficiency possible. The switch node waveforms for CCM and DCM operation are shown in [Figure 6](#) and [Figure 7](#).

8.3.3.2 Power-Up And Soft-Start (Boost Converter)

The boost converter starts switching as soon as one enable signal is pulled HIGH and the voltage on V_{IN} pin is above the UVLO threshold. For TPS65132Ax, in the case where one enable signal is already HIGH when V_{IN} reaches the UVLO threshold, the boost converter will only start switching after a 40 ms delay has passed (see [Undervoltage Lockout \(UVLO\)](#)).

The boost converter starts up with an integrated soft-start to avoid drawing excessive inrush current from the supply. The output voltage V_{REG} is slowly ramped up to its target value. Typical startup waveforms for low-current applications are shown in [Figure 33](#) and [Figure 35](#).

8.3.3.3 Power-Down (Boost Converter)

The boost converter stops switching when V_{IN} is below the UVLO threshold or when both output rails are disabled. For example, due to a special sequencing, the LDO might still be operating while the CPN is already disabled, in which case, the boost will continue operating until the LDO has been disabled. Typical power-down waveforms for low-current applications are shown in [Figure 34](#) and [Figure 36](#).

8.3.3.4 Isolation (Boost Converter)

The boost converter output (REG) is isolated from the input supply V_{IN} , providing a true shutdown.

8.3.3.5 Output Voltage (Boost Converter)

The output voltage of the boost converter is automatically adjusted depending on the programmed V_{POS} and V_{NEG} voltages.

8.3.3.6 Advanced Power-Save Mode For Light-Load Efficiency And PFM

The TPS65132 device integrates a power save mode to improve efficiency at light load. In power save mode the converter stops switching when the inductor current reaches 0 A. The device resumes its switching activity with one or more pulses once the V_{REG} voltage falls below its regulation level, and goes again into power save mode once the inductor current reaches 0 A. The pulse duration remains constant, but the frequency of these pulses varies according to the output load. This operating mode is also known as Pulse Frequency Modulation or PFM. [Figure 6](#) provides plots of the inductor current and the switch node in PFM mode.

Feature Description (continued)

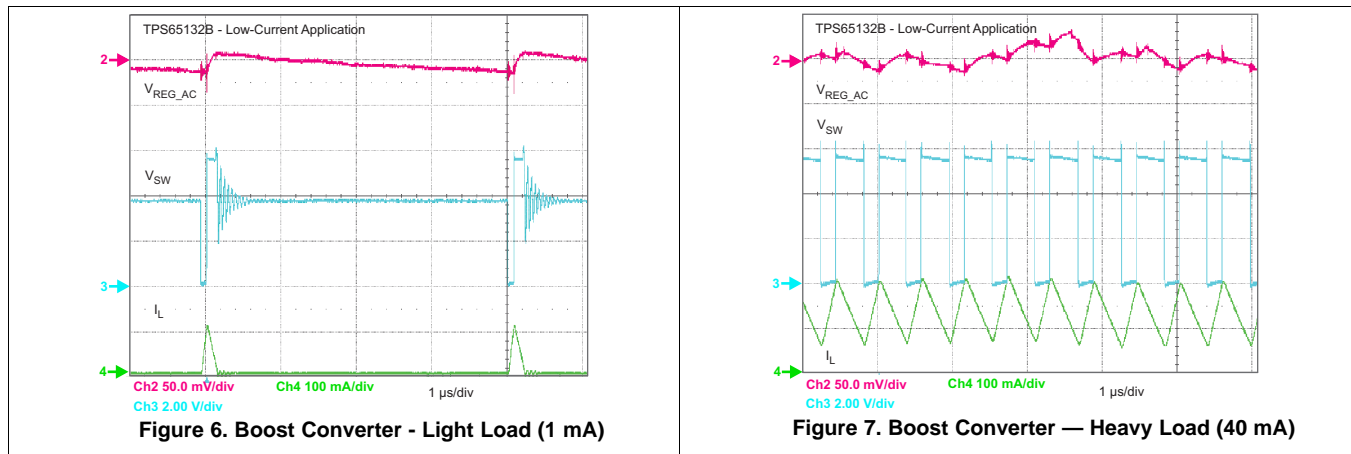

8.3.4 LDO Regulator

8.3.4.1 LDO Operation

The Low Dropout regulator (or LDO) generates the positive voltage rail, V_{POS} , by regulating down the output voltage of the boost converter (V_{REG}). Its inherent power supply rejection helps filtering the output ripple of the boost converter in order to provide on OOTP pin a clean voltage, e.g. to supply the source driver IC of the display.

8.3.4.2 Power-Up And Soft-Start (LDO)

The LDO starts operating as soon as the ENP signal is pulled HIGH, V_{IN} voltage is above the UVLO threshold and the boost converter has reached its Power Good threshold.

In the case where the enable signal is already HIGH when V_{IN} exceeds the UVLO threshold, the boost converter will start first and the LDO will only start after the boost converter has reached its target voltage. For TPS65132Ax, the boost will start after the 40 ms delay has passed (see [Undervoltage Lockout \(UVLO\)](#)).

For TPS65132Sx the LDO startup is defined by the setting of the DLYx register and the SEQU bits, see [Registers](#) for more details.

The LDO integrates a soft-start that slowly ramps up its output voltage V_{POS} regardless of the output capacitor and the target voltage, as long as the LDO current limit is not reached. For TPS65132Ax and TPS65132Bx (except TPS65132B2), the typical startup time is 140 μ s. For TPS65132B2, TPS65132Lx, TPS65132Sx, TPS65132Tx and TPS65132Wx, the typical ramp-up time is 500 μ s and the inrush current is also reduced by a factor of 3. Typical startup waveforms for the low-current application are shown in [Figure 33](#) to [Figure 35](#).

8.3.4.3 Power-Down And Discharge (LDO)

The LDO stops operating when V_{IN} is below the UVLO threshold or when ENP is pulled LOW. Or for TPS65132Sx when EN is pulled LOW, and the internal sequencing has passed.

The positive rail can be actively discharged to GND during power-down if required. A discharge selection bit is available to enable or disable this function. See [Registers](#) for more details, as well as waveforms in [Figure 37](#) and [Figure 38](#). [Table 1](#) shows the V_{POS} active discharge behavior of each device variant.

Table 1. V_{POS} Active Discharge Behavior

PART NUMBER	V_{IN}	ENP (or EN)	ENN (or SYNC)	V_{POS} DISCHARGE
TPS65132Ax	$< V_{UVLO}$	Don't Care	Don't Care	On
		Low	Low	Determined by DISP bit
	$> V_{UVLO}$	Low	High	Determined by DISP bit
		High	Low	Off
		High	High	Off

Feature Description (continued)
Table 1. V_{POS} Active Discharge Behavior (continued)

PART NUMBER	V _{IN}	ENP (or EN)	ENN (or SYNC)	V _{POS} DISCHARGE
TPS65132Bx TPS65132Lx TPS65132Sx TPS65132Tx TPS65132Wx	< V _{UVLO}	Don't Care	Don't Care	On
	> V _{UVLO}	Low	Low	On
		Low	High	Determined by DISP bit
		High	Low	Off
		High	High	Off

8.3.4.4 Isolation (LDO)

The LDO is isolating the V_{POS} rail from V_{REG} (boost converter output) as long as the rail is not enabled in order to ensure flexible startup like V_{NEG} before V_{POS}.

8.3.4.5 Setting The Output Voltage (LDO)

The output voltage of the LDO is programmable via a I²C compatible interface, from –6.0 V to –4.0 V in 100 mV steps. For more details, please refer to the [VPOS Register – Address: 0x00](#)

8.3.5 Negative Charge Pump
8.3.5.1 Operation

The negative charge pump (CPN) generates the negative voltage rail, V_{NEG}, by inverting and regulating the output voltage of the boost converter (V_{REG}). The charge pump uses 4 switches and an external flying capacitor to generate the negative rail. Two of the switches are turned on in the first phase to charge the flying capacitor up to V_{REG}, and in the second phase they are turned-off and the two others turn on to pump the energy negatively out of the OUTN capacitor.

8.3.5.2 Power-Up And Soft-Start (CPN)

The CPN starts operating as soon as the ENN signal is pulled HIGH, V_{IN} voltage is above the UVLO threshold and the boost converter has reached its Power Good threshold.

In the case where the enable signal is already HIGH when V_{IN} reaches the UVLO threshold, the boost converter will start first and the CPN will only start after the boost converter has reached its target voltage. For TPS65132Ax, the boost will start after the 40 ms delay has passed (see [Undervoltage Lockout \(UVLO\)](#)).

For TPS65132Sx the CPN startup is defined by the setting of the DLYx register and the SEQU bits, see [Registers](#) for more details.

The CPN integrates a soft-start that slowly ramps up its output voltage V_{NEG} within a time defined by the selected mode (40mA or 80mA), the output voltage and the output capacitor value. For TPS65132Ax and TPS65132Bx (except TPS65132B2), the startup current charging the output capacitor in 40mA mode is 50 mA, and 100 mA typically in 80mA mode. For TPS65132B2, TPS65132Lx, TPS65132Tx, and TPS65132Wx, the typical ramp-up times are slowed down by a factor of 4 (i.e 12.5 mA and 25 mA typical output current for 40mA and 80mA modes respectively) and the inrush current is also reduced by a factor of about 4. Typical startup waveforms for the low-current application are shown in [Figure 39](#) to [Figure 42](#).

For TPS65132Sx, the negative rail starts-up in 40mA or 80mA mode, thus the startup current is set by the mode the device is programmed to, and not related to the SYNC pin state. The full current of 150 mA minimum is only released once both rails (V_{POS} and V_{NEG}) have reached their Power Good levels.

The estimated startup time can be calculated using the following formula:

$$t_{\text{STARTUP}} = \frac{C_{\text{OUT}} \times V_{\text{NEG}}}{I_{\text{STARTUP}}}$$

Where:

- t_{STARTUP} = startup time of the V_{NEG} rail
- C_{OUT} = output capacitance of the V_{NEG} rail
- V_{NEG} = target output voltage

I_{STARTUP} = output current of the V_{NEG} rail charging up the output capacitor at startup (12.5 mA, 25 mA, 50 mA or 100 mA as described above)

8.3.5.3 Power-Down And Discharge (CPN)

The CPN stops operating when V_{IN} is below the UVLO threshold or when ENN is pulled LOW.

Or when EN is pulled LOW in the TPS65132Sx, and the internal sequencing has passed.

The negative rail can be actively discharged to GND during power-down if required. A discharge selection bit is available to enable or disable this function. See for more details, as well as waveforms [Figure 37](#) and [Figure 38](#). [Table 2](#) shows the V_{NEG} discharge behavior of each device variant.

Table 2. V_{NEG} Active Discharge Behavior

PART NUMBER	V_{IN}	ENP (or EN)	ENN (or SYNC)	V_{NEG} DISCHARGE
TPS65132Ax	$< V_{\text{UVLO}}$	Don't Care	Don't Care	On
	$> V_{\text{UVLO}}$	Low	Low	Determined by DISN bit
		Low	High	Off
		High	Low	Determined by DISN bit
		High	High	Off
TPS65132Bx TPS65132Lx TPS65132Tx TPS65132Wx	$< V_{\text{UVLO}}$	Don't Care	Don't Care	On
	$> V_{\text{UVLO}}$	Low	Low	On
		Low	High	Off
		High	Low	Determined by DISN bit
		High	High	Off
TPS65132Sx	$< V_{\text{UVLO}}$	Don't Care	Don't Care	On
	$> V_{\text{UVLO}}$	Low	Low	On
		Low	High	Determined by DISN bit
		High	Low	Off
		High	High	Off

8.3.5.4 Isolation (CPN)

The CPN isolates the V_{NEG} rail from V_{REG} (boost converter output) as long as the rail is not enabled in order to ensure flexible startup like V_{POS} before V_{NEG} .

8.3.5.5 Setting The Output Voltage (CPN)

The output voltage of the CPN is programmable via a I²C compatible interface, from –4.0 V to –6.0 V in 100 mV steps. For more details, please refer to the [VNEG Register – Address 0x01](#).

8.4 Device Functional Modes

8.4.1 Enabling and Disabling the Device

At startup (V_{IN} goes above UVLO and at least one of the enable pins (ENP, ENN, or EN) goes HIGH), the EEPROM content is loaded into the DAC registers and the IC starts with these default values. The TPS65132 is enabled as long as the V_{IN} voltage is above the UVLO and one of the enable pins (ENP, ENN, or EN) is HIGH.

Pulling ENP or ENN LOW disables either rail (V_{POS} or V_{NEG} respectively); and, pulling both pins LOW disables the device entirely (the internal oscillator of the TPS65132Ax continues running to allow access to the I²C interface).

For TPS65132Sx, pulling EN LOW disables the device.

8.5 Programming

8.5.1 I²C Serial Interface Description

The TPS65132 communicates through an industry standard I²C compatible interface, to receive data in slave mode. I²C is a 2-wire serial interface developed by Philips Semiconductor (see I²C-Bus Specification, Version 2.1, January 2000).

The TPS65132 integrates a non-volatile memory (EEPROM) that allows the storage of the register values with a capability of up to 1000 programming cycles. At startup the TPS65132 loads first the EEPROM content into the registers and uses these voltages to start.

It is recommended to stop I²C communication with the TPS65132 for 50 ms after the command "Write EEPROM data" was sent. If the device is accessed via I²C during EEPROM programming, the device will pull down the SCL line (clock stretch) after it recognized its I²C address. The SCL line will be released after EEPROM programming is finished.

The TPS65132 works as a slave and supports the following data transfer modes, as defined in the I²C-Bus specification: standard mode (100 kbps) and fast mode (400 kbps). The data transfer protocol for standard and fast modes is exactly the same, therefore they are referred to as F/S-mode in this document. The TPS65132 supports 7-bit addressing. The device 7-bit address is 3E (see Figure 8), and the LSB enables the write or read function.

Figure 8. TPS65132 Slave Address Byte

MSB		TPS65132				Address		LSB
0	1	1	1	1	1	1	0	R/W
R/W = R/(W)								

NOTE

With TPS65132Ax, the I²C interface is accessible as long as the input voltage is above the undervoltage lockout threshold. In all other versions, the I²C interface is accessible only as soon as one of the enable pins is pulled HIGH while the input voltage is above the undervoltage lockout.

8.5.2 I²C Interface Protocol

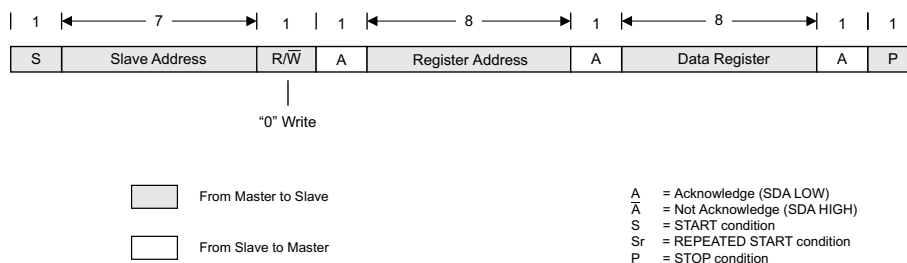

Figure 9. "Write" Data To DAC – Transfer Format In F/S-Mode

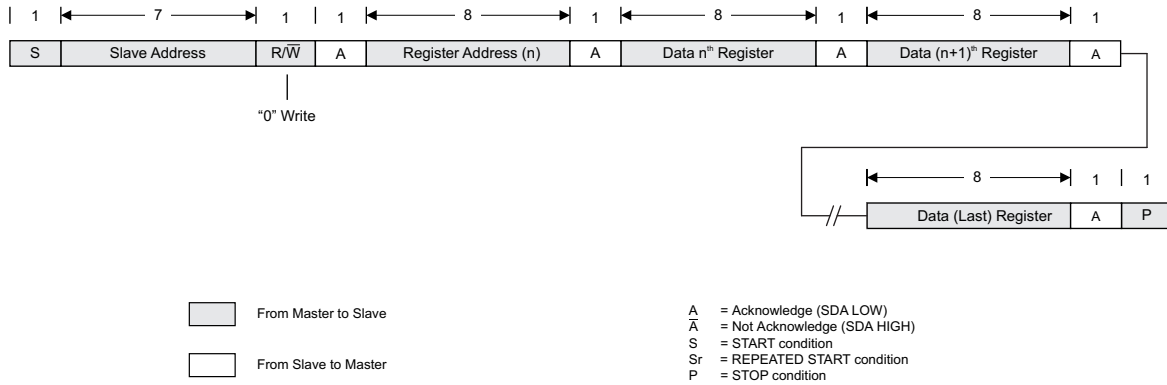

Figure 10. "Write" Data To DAC – Transfer Format In F/S-Mode Featuring Register Address Auto-Increment

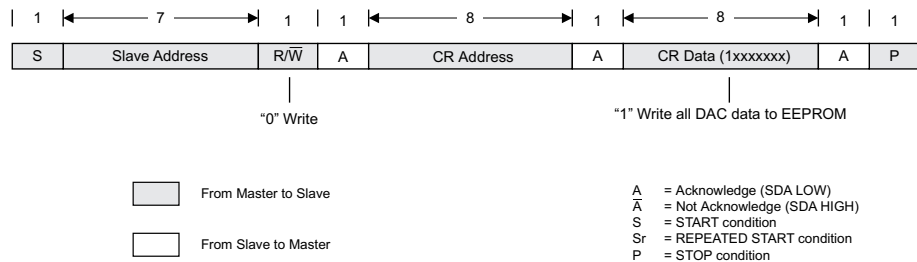

Figure 11. "Write" Data To EEPROM – Transfer Format In F/S-Mode

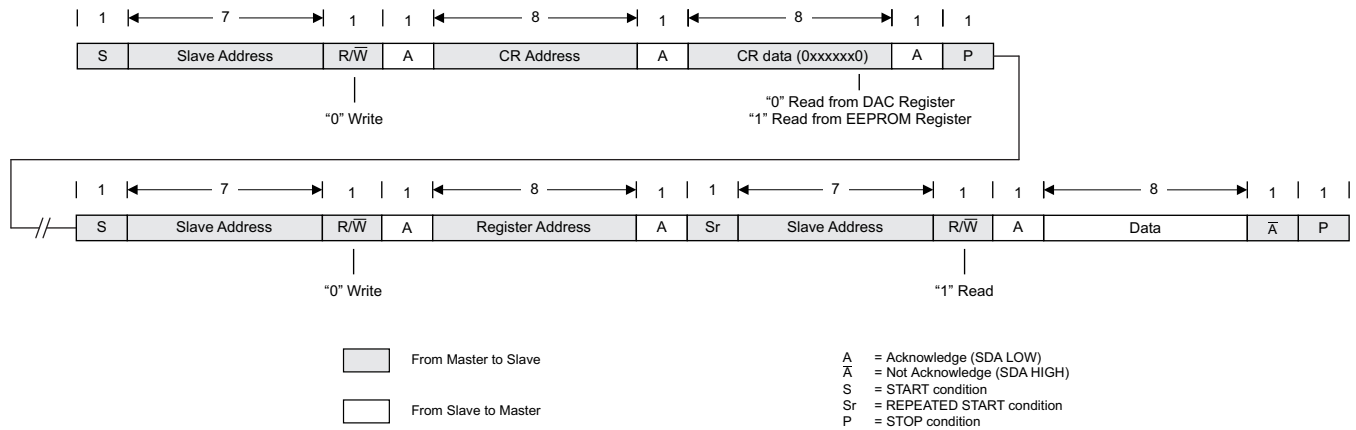

Figure 12. "Read" Data From DAC/EEPROM – Transfer Format In F/S-Mode

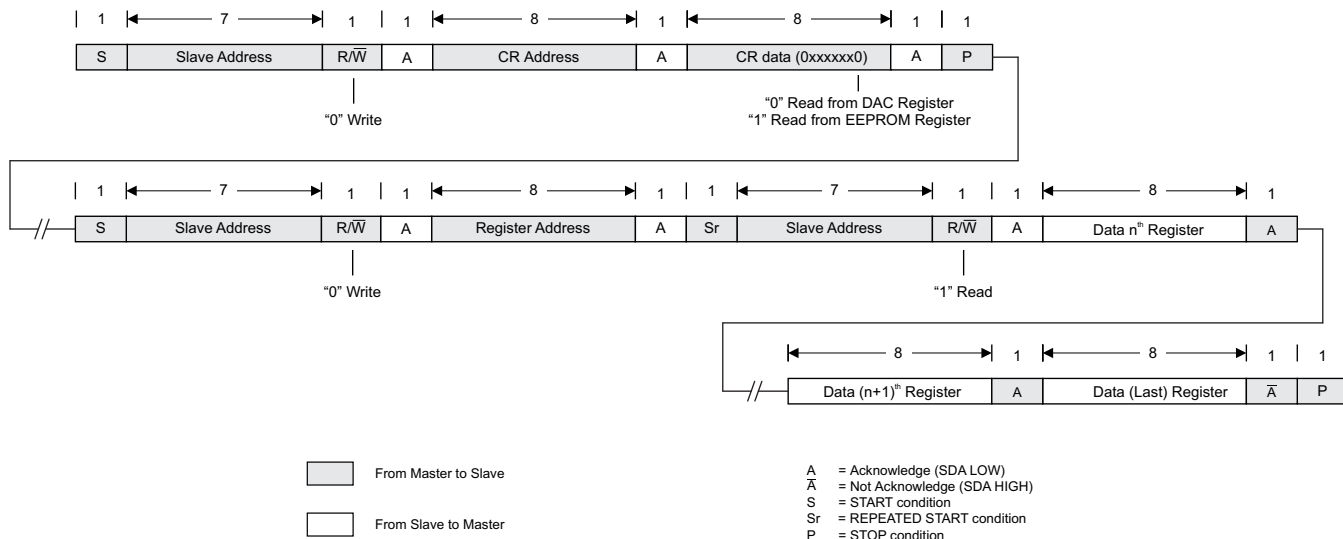

Figure 13. “Read” Data From DAC/EEPROM – Transfer Format In F/S-Mode Featuring Register Address Auto-Increment

8.6 Register Maps

The TPS65132 has a non-volatile memory (EEPROM) which contains the initial values and one volatile memory (Registers) which contains the actual settings. The EEPROM and the Registers are accessed with the same address.

Startup option: At power-up, the values contained in the EEPROM are loaded into the Registers to the last stored setting within less than 20 μ s. The programmed factory value of the EEPROM of each address is described in section [Factory Default Register Value](#).

Write description: The user has to program all Registers first (0x00 to 0x03), then set the WED (Write EEPROM Data) bit to 1. A dead time of 50 ms is then initiated during which the register content or all registers (0x00 ~ 0x03) are stored into the non-volatile EEPROM cells. During that time, there should be no data flowing through the I²C because the I²C interface is momentarily not responding.

After the 50 ms have passed, the WED bit is automatically reset to 0, and the user is able to read the values or program again.

Slave address: 0x3E

X = R/W

R/W = 1 → read mode

R/W = 0 → write mode

8.6.1 Registers

Attempting to read data from register addresses not listed in the following section will result in 0x00 being read out.

8.6.1.1 VPOS Register – Address: 0x00

Figure 14. VPOS Register

7	6	5	4	3	2	1	0	
RSVD	RSVD	RSVD	VPOS[4:0]					
0	0	0	0	1	1	1	0	
R			R/W					

LEGEND: R/W = Read/Write; R = Read only; -n = value after reset

Table 3. VPOS Register Field Descriptions

Bit	Field	Description																																																
7:5	RSVD[2:0]	Reserved, always set to 0																																																
4:0	VPOS[4:0]	VPOS output voltage adjustment																																																
		<table border="1"> <thead> <tr> <th>VPOS[4:0] Value (binary)</th> <th>VPOS Output Voltage (V)</th> <th>VPOS[4:0] Value (binary)</th> <th>VPOS Output Voltage (V)</th> </tr> </thead> <tbody> <tr> <td>00000</td> <td>4.0</td> <td>01011</td> <td>5.1</td> </tr> <tr> <td>00001</td> <td>4.1</td> <td>01100</td> <td>5.2</td> </tr> <tr> <td>00010</td> <td>4.2</td> <td>01101</td> <td>5.3</td> </tr> <tr> <td>00011</td> <td>4.3</td> <td>01110</td> <td>5.4</td> </tr> <tr> <td>00100</td> <td>4.4</td> <td>01111</td> <td>5.5</td> </tr> <tr> <td>00101</td> <td>4.5</td> <td>10000</td> <td>5.6</td> </tr> <tr> <td>00110</td> <td>4.6</td> <td>10001</td> <td>5.7</td> </tr> <tr> <td>00111</td> <td>4.7</td> <td>10010</td> <td>5.8</td> </tr> <tr> <td>01000</td> <td>4.8</td> <td>10011</td> <td>5.9</td> </tr> <tr> <td>01001</td> <td>4.9</td> <td>10100</td> <td>6.0</td> </tr> <tr> <td>01010</td> <td>5.0</td> <td></td> <td></td> </tr> </tbody> </table>	VPOS[4:0] Value (binary)	VPOS Output Voltage (V)	VPOS[4:0] Value (binary)	VPOS Output Voltage (V)	00000	4.0	01011	5.1	00001	4.1	01100	5.2	00010	4.2	01101	5.3	00011	4.3	01110	5.4	00100	4.4	01111	5.5	00101	4.5	10000	5.6	00110	4.6	10001	5.7	00111	4.7	10010	5.8	01000	4.8	10011	5.9	01001	4.9	10100	6.0	01010	5.0		
		VPOS[4:0] Value (binary)	VPOS Output Voltage (V)	VPOS[4:0] Value (binary)	VPOS Output Voltage (V)																																													
		00000	4.0	01011	5.1																																													
		00001	4.1	01100	5.2																																													
		00010	4.2	01101	5.3																																													
		00011	4.3	01110	5.4																																													
		00100	4.4	01111	5.5																																													
		00101	4.5	10000	5.6																																													
		00110	4.6	10001	5.7																																													
		00111	4.7	10010	5.8																																													
		01000	4.8	10011	5.9																																													
		01001	4.9	10100	6.0																																													
01010	5.0																																																	

8.6.1.2 VNEG Register – Address 0x01
Figure 15. VNEG Register

7	6	5	4	3	2	1	0
RSVD	RSVD	RSVD	VNEG[4:0]				
0	0	0	0	1	1	1	0
R			R/W				

LEGEND: R/W = Read/Write; R = Read only; -n = value after reset

Table 4. VNEG Register Field Descriptions

Bit	Field	Description																																																
7:5	RSVD[2:0]	Reserved, always set to 0																																																
4:0	VNEG[4:0]	VNEG output voltage adjustment																																																
		<table border="1"> <thead> <tr> <th>VNEG[4:0] Value (binary)</th> <th>VNEG Output Voltage (V)</th> <th>VNEG[4:0] Value (binary)</th> <th>VNEG Output Voltage (V)</th> </tr> </thead> <tbody> <tr><td>00000</td><td>-4.0</td><td>01011</td><td>-5.1</td></tr> <tr><td>00001</td><td>-4.1</td><td>01100</td><td>-5.2</td></tr> <tr><td>00010</td><td>-4.2</td><td>01101</td><td>-5.3</td></tr> <tr><td>00011</td><td>-4.3</td><td>01110</td><td>-5.4</td></tr> <tr><td>00100</td><td>-4.4</td><td>01111</td><td>-5.5</td></tr> <tr><td>00101</td><td>-4.5</td><td>10000</td><td>-5.6</td></tr> <tr><td>00110</td><td>-4.6</td><td>10001</td><td>-5.7</td></tr> <tr><td>00111</td><td>-4.7</td><td>10010</td><td>-5.8</td></tr> <tr><td>01000</td><td>-4.8</td><td>10011</td><td>-5.9</td></tr> <tr><td>01001</td><td>-4.9</td><td>10100</td><td>-6.0</td></tr> <tr><td>01010</td><td>-5.0</td><td></td><td></td></tr> </tbody> </table>	VNEG[4:0] Value (binary)	VNEG Output Voltage (V)	VNEG[4:0] Value (binary)	VNEG Output Voltage (V)	00000	-4.0	01011	-5.1	00001	-4.1	01100	-5.2	00010	-4.2	01101	-5.3	00011	-4.3	01110	-5.4	00100	-4.4	01111	-5.5	00101	-4.5	10000	-5.6	00110	-4.6	10001	-5.7	00111	-4.7	10010	-5.8	01000	-4.8	10011	-5.9	01001	-4.9	10100	-6.0	01010	-5.0		
		VNEG[4:0] Value (binary)	VNEG Output Voltage (V)	VNEG[4:0] Value (binary)	VNEG Output Voltage (V)																																													
		00000	-4.0	01011	-5.1																																													
		00001	-4.1	01100	-5.2																																													
		00010	-4.2	01101	-5.3																																													
		00011	-4.3	01110	-5.4																																													
		00100	-4.4	01111	-5.5																																													
		00101	-4.5	10000	-5.6																																													
		00110	-4.6	10001	-5.7																																													
		00111	-4.7	10010	-5.8																																													
		01000	-4.8	10011	-5.9																																													
		01001	-4.9	10100	-6.0																																													
01010	-5.0																																																	

8.6.1.3 DLYx Register – Address 0x02 (Only valid for TPS65132Sx)
Figure 16. DLYx Register

7	6	5	4	3	2	1	0
DLYP2	DLYP2	DLYN2	DLYN2	DLYP1	DLYP1	DLYN1	DLYN1
0	0	0	0	0	0	0	1
R/W							

Table 5. DLYx Register Field Descriptions

Bit	Field	Description	
7:6	DLYP2[1:0]	Delay in milliseconds	
5:4	DLYN2[1:0]		
3:2	DLYP1[1:0]		
1:0	DLYN1[1:0]		
	DLYx[1:0]	DLYx Value (binary)	DLYx Delay (ms)
		00	0
		01	1
		10	5
		11	10

8.6.1.4 APPS - SEQU - SEQD - DISP - DISN Register – Address 0x03
Figure 17. APPS - SEQU - SEQD - DISP - DISN Register

7	6	5	4	3	2	1	0
RSVD	APPS	SEQU	SEQU	SEQD	SEQD	DISP	DISN
0	0	0	0	0	0	1	0
R	R/W	R/W	R/W	R/W	R/W	R/W	R/W

LEGEND: R/W = Read/Write; R = Read only; -n = value after reset

Table 6. APPS - SEQU - SEQD - DISP - DISN Field Descriptions

Bit	Field	Description	Value (binary)	Action	
7	RSVD	Reserved, always set to 0			
6	APPS	Application	APPS Value	0	40mA
				1	80mA
5:4	SEQU ⁽¹⁾	Sequencing at Startup	SEQU Value	00	V _{POS} and V _{NEG} simultaneously (DLYP1 after EN goes HIGH)
				01	V _{POS} (DLYP1 after EN goes HIGH) and then V _{NEG} (DLYN1 after V _{POS})
				10	V _{NEG} (DLYN1 after EN goes HIGH) and then V _{POS} (DLYP1 after V _{NEG})
				11	V _{POS} only
3:2	SEQD ⁽¹⁾	Sequencing at Shutdown	SEQD Value	00	V _{POS} and V _{NEG} simultaneously (DLYP2 after EN goes LOW)
				01	V _{POS} (DLYP2 after EN goes LOW) and then V _{NEG} (DLYN2 after V _{POS})
				10	V _{NEG} (DLYN2 after EN goes LOW) and then V _{POS} (DLYP2 after V _{NEG})
				11	Ignored
1	DISP ⁽²⁾	Discharge V _{POS}	DISP Value	0	No discharge
				1	V _{POS} actively discharged
0	DISN ⁽²⁾	Discharge V _{NEG}	DISN Value	0	No discharge
				1	V _{NEG} actively discharged

(1) SEQU and SEQD bits are just valid for TPS65132Sx

(2) See [Power-Down And Discharge \(LDO\)](#) and [Power-Down And Discharge \(CPN\)](#) for a detailed description of how each device variant implements the active discharge function.

8.6.1.5 Control Register – Address 0xFF
Figure 18. Control Register

7	6	5	4	3	2	1	0
WED	RSVD[6:1]						EE/(DR)

The **Reserved** bits are ignored when written and return either 0 or 1 when read.

Table 7. Control Register Field Descriptions

Bit	Field	Value (binary)	Description
7	WED	0	No action
		1	Write EEPROM Data
6:1	RSVD[6:1]	Reserved	
0	EE/(DR)	0	Read from Registers
		1	Read from EEPROM

8.6.2 Factory Default Register Value

Part number	Register address			
	0x00	0x01	0x02	0x03
TPS65132A	0x0E	0x0E	—	0x03
TPS65132A0	0x0A	0x0A	—	0x03
TPS65132B	0x0E	0x0E	—	0x03
TPS65132B0	0x0A	0x0A	—	0x03
TPS65132B2	0x0C	0x0C	—	0x03
TPS65132B5	0x0F	0x0F	—	0x03
TPS65132L	0x0E	0x0E	—	0x03
TPS65132L0	0x0A	0x0A	—	0x03
TPS65132L1 ⁽¹⁾	0x0B	0x0B	—	0x03
TPS65132S	0x0E	0x0E	0x00	0x43
TPS65132T6	0x10h	0x10h	—	0x43
TPS65132W	0x0E	0x0E	—	0x43

(1) Product preview.

9 Application and Implementation

NOTE

Information in the following applications sections is not part of the TI component specification, and TI does not warrant its accuracy or completeness. TI's customers are responsible for determining suitability of components for their purposes. Customers should validate and test their design implementation to confirm system functionality.

9.1 Application Information

The TPS65132xx devices, primarily intended to supplying TFT LCD displays, can be used for any application that requires positive and negative supplies, ranging from ± 4 V to ± 6 V and current up to 80 mA (150 mA for the TPS65132Sx version). Both output voltages can be set independently and their sequencing is also independent. The following section presents the different operating modes that the device can support as well as the different features that the user can select.

9.2 Typical Applications

9.2.1 Low-current Applications (≤ 40 mA)

The TPS65132 can be programmed to 40mA mode with the APPS bit to support applications that require output currents up to 40 mA (refer to [Figure 17](#)). The 40mA mode limits the negative charge pump output current to 40 mA DC in order to provide the highest efficiency possible. The V_{POS} rail can deliver up to 200 mA DC regardless of the mode. Output peak currents are supported by the output capacitors.

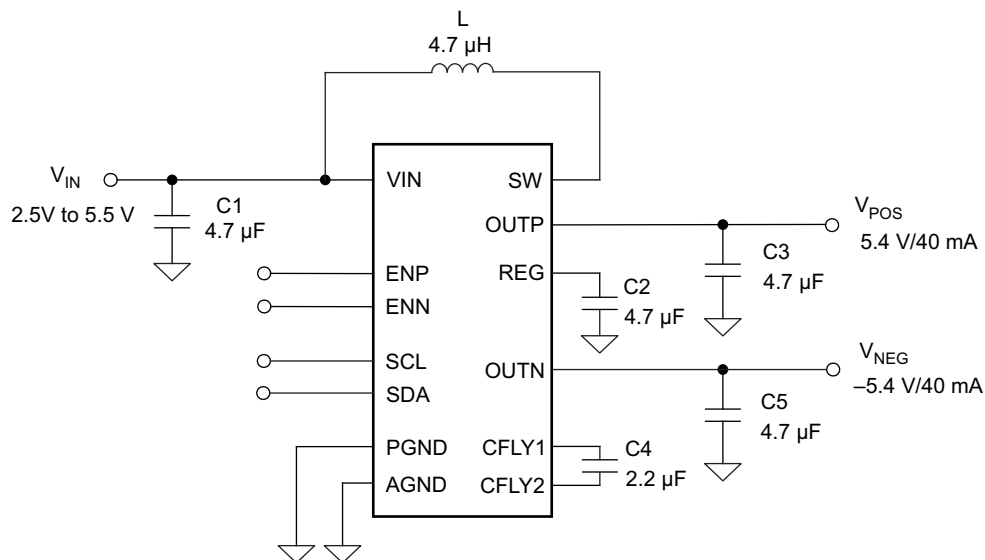

Figure 19. Typical Low-current Application Circuit

9.2.1.1 Design Requirements

Table 8. Design Parameters

PARAMETERS	EXAMPLE VALUES
Input Voltage Range	2.5 V to 5.5 V
Output Voltages	4.0 V to 6.0 V, -4.0 V to -6.0 V
Output Current Rating	40 mA
Boost Converter Switching Frequency	1.8 MHz
Negative Charge Pump Switching Frequency	1.0 MHz

9.2.1.2 Detailed Design Procedure

9.2.1.2.1 Sequencing

Each output rail (V_{POS} and V_{NEG}) is enabled and disabled using an external enable signal. If not explicitly specified, the enable signal in the rest of the document refers to ENN or ENP: ENP for the positive rail V_{POS} and ENN for the negative rail V_{NEG} . [Figure 33](#) to [Figure 36](#) show the typical sequencing waveforms.

NOTE

In the case where V_{IN} falls below the UVLO threshold while one of the enable signals is still high, all converters will be shut down instantaneously and both V_{POS} and V_{NEG} output rails will be actively discharged to GND.

9.2.1.2.2 Boost Converter Design Procedure

The first step in the design procedure is to verify whether the maximum possible output current of the boost converter supports the specific application requirements. A simple approach is to estimate the converter efficiency, by taking the efficiency number from the provided efficiency curves at the application's maximum load or to use a worst case assumption for the expected efficiency, e.g., 85%.

1. Duty Cycle: $D = 1 - \frac{V_{IN_min} \times \eta}{V_{REG}}$
2. Inductor ripple current: $\Delta I_L = \frac{V_{IN_min} \times D}{f_{SW} \times L}$
3. Maximum output current: $I_{OUT_max} = \left(I_{LIM_min} + \frac{\Delta I_L}{2} \right) \times (1-D)$
4. Peak switch current of the application: $I_{SWPEAK} = \frac{I_{OUT}}{1-D} + \frac{\Delta I_L}{2}$
 η = Estimated boost converter efficiency (use the number from the efficiency plots or 85% as an estimation)
 f_{SW} = Boost converter switching frequency (1.8 MHz)
 L = Selected inductor value for the boost converter (see the Inductor Selection section)
 I_{SWPEAK} = Boost converter switch current at the desired output current (must be $< [I_{LIM_min} + \Delta I_L]$)
 ΔI_L = Inductor peak-to-peak ripple current
 $V_{REG} = \max(V_{POS}, |V_{NEG}|) + 200 \text{ mV}$ (in 40mA mode — + 300 mV in 80mA mode — + 500 mV with TPS65132Sx with SYNC = HIGH)
 $I_{OUT} = I_{OUT_VPOS} + |I_{OUT_VNEG}|$ (I_{OUT_max} being the maximum current delivered on each rail)

The peak switch current is the current that the integrated switch and the inductor have to handle. The calculation must be done for the minimum input voltage where the peak switch current is highest.

9.2.1.2.2.1 Inductor Selection (Boost Converter)

Saturation current: the inductor must handle the maximum peak current ($I_{L_SAT} > I_{SWPEAK}$, or $I_{L_SAT} > [I_{LIM_min} + \Delta I_L]$ as conservative approach)

DC Resistance: the lower the DCR, the lower the losses

Inductor value: in order to keep the ratio $I_{OUT}/\Delta I_L$ low enough for proper sensing operation purpose, it is recommended to use a 4.7 μH inductor for 40mA mode (a 2.2 μH might however be used, but the efficiency might be lower than with 4.7 μH at light loads depending on the inductor characteristics).

Table 9. Inductor Selection Boost⁽¹⁾

L (μH)	SUPPLIER ⁽¹⁾	COMPONENT CODE	EIA SIZE	DCR TYP (mΩ)	I _{SAT} (A)
2.2	Toko	1269AS-H-2R2N=P2	1008	130	2.4
2.2	Murata	LQM2HPN2R2MG0	1008	80	1.3
2.2	Murata	LQM21PN2R2NGC	0805	250	0.8
4.7	Toko	1269AS-H-4R7N=P2	1008	250	1.6
4.7	Murata	LQM21PN4R7MGR	0805	230	0.8
4.7	FDK	MIPS2520D4R7	1008	280	0.7

(1) See [Third-Party Products Disclaimer](#)

9.2.1.2.2.2 Input Capacitor Selection (Boost Converter)

For best input voltage filtering low ESR ceramic capacitors are recommended. TPS65132 has an analog input pin VIN. A 4.7 μF minimum bypass capacitor is required as close as possible from VIN to GND. This capacitor is also used as the boost converter input capacitor.

For better input voltage filtering, this value can be increased or two capacitors can be used: one 4.7 μF input capacitor for the boost converter as well as a 1 μF bypass capacitor close to the VIN pin. Refer to the [Recommended Operating Conditions](#), [Table 10](#) and [Figure 19](#) for input capacitor recommendations.

9.2.1.2.2.3 Output Capacitor Selection (Boost Converter)

For the best output voltage filtering, low-ESR ceramic capacitors are recommended. A minimum of 4.7 μF ceramic output capacitor is required. Higher capacitor values can be used to improve the load transient response. Refer to the [Recommended Operating Conditions](#), [Table 10](#) and [Figure 19](#) for output capacitor recommendations.

Table 10. Input And Output Capacitor Selection⁽¹⁾

CAPACITOR (μF)	SUPPLIER	COMPONENT CODE	EIA SIZE (Thickness max.)	VOLTAGE RATING (V)	COMMENTS
2.2	Murata	GRM188R61C225KAAD	0603 (0.9 mm)	16	C _{FLY}
4.7	Murata	GRM188R61C475KAAJ	0603 (0.95 mm)	16	C _{IN} , C _{NEG} , C _{POS} , C _{REG}
10	Murata	GRM219R61C106KA73	0603 (0.95 mm)	16	C _{NEG} , C _{REG}

(1) See [Third-Party Products Disclaimer](#)

9.2.1.2.3 Input Capacitor Selection (LDO)

The LDO input capacitor is also the boost converter output capacitor. Refer to the [Recommended Operating Conditions](#), [Table 10](#) and [Figure 19](#).

9.2.1.2.4 Output Capacitor Selection (LDO)

The LDO is designed to operate with a 4.7 μF minimum ceramic output capacitor. Refer to the [Recommended Operating Conditions](#), [Table 10](#) and [Figure 19](#).

9.2.1.2.5 Input Capacitor Selection (CPN)

The CPN input capacitor is also the boost converter output capacitor. Refer to the [Recommended Operating Conditions](#), [Table 10](#) and [Figure 19](#).

9.2.1.2.6 Output Capacitor Selection (CPN)

The CPN is designed to operate with a 4.7 μF minimum ceramic output capacitor. Refer to the [Recommended Operating Conditions](#), [Table 10](#) and [Figure 19](#).

9.2.1.2.7 Flying Capacitor Selection (CPN)

The CPN needs an external flying capacitor. The minimum value is 2.2 μF . Special care must be taken while choosing the flying capacitor as it will directly impact the output voltage accuracy and load regulation performance. Therefore, a minimum capacitance of 1 μF must be achieved by the capacitor at a DC bias voltage of $|V_{\text{NEG}}| + 300 \text{ mV}$. For proper operation, the flying capacitor value must be lower than the output capacitor of the boost converter on REG pin.

9.2.1.3 Application Curves

$V_{\text{IN}} = 3.7 \text{ V}$, $V_{\text{POS}} = 5.4 \text{ V}$, $V_{\text{NEG}} = -5.4 \text{ V}$, unless otherwise noted

Table 11. Component List Used For The Application Curves

REFERENCE	DESCRIPTION	MANUFACTURER AND PART NUMBER ⁽¹⁾
C	2.2 μF , 16 V, 0603, X5R, ceramic	Murata - GRM188R61C225KAAD
	4.7 μF , 16 V, 0603, X5R, ceramic	Murata - GRM188R61C475KAAJ
	10 μF , 16 V, 0603, X5R, ceramic	Murata - GRM188R61E106MA73
L	2.2 μH , 2.4 A, 130 m Ω , 2.5 mm \times 2.0 mm \times 1.0 mm	Toko - DFE252010C (1269AS-H-2R2N=P2)
	4.7 μH , 1.6 A, 250 m Ω , 2.5 mm \times 2.0 mm \times 1.0 mm	Toko - DFE252010C (1269AS-H-4R7N=P2)
U1	TPS65132AYFF	Texas Instruments

(1) See [Third-Party Products Disclaimer](#)

Table 12. Table Of Graphs

PARAMETER	CONDITIONS	Figure
EFFICIENCY		
Efficiency vs. Output Current	$\pm 5.0 \text{ V} - 40\text{mA Mode} - L = 4.7 \mu\text{H}$	Figure 20
Efficiency vs. Output Current	$\pm 5.4 \text{ V} - 40\text{mA Mode} - L = 4.7 \mu\text{H}$	Figure 21
Efficiency vs. Output Current	$\pm 5.0 \text{ V} - 40\text{mA Mode} - L = 2.2 \mu\text{H}$	Figure 22
Efficiency vs. Output Current	$\pm 5.4 \text{ V} - 40\text{mA Mode} - L = 2.2 \mu\text{H}$	Figure 23
CONVERTERS WAVEFORMS		
V_{NEG} Output Ripple	$I_{\text{NEG}} = 2 \text{ mA} / 20 \text{ mA} / 40 \text{ mA} - 40\text{mA Mode} - C_{\text{OUT}} = 4.7 \mu\text{F}$	Figure 24
V_{NEG} Output Ripple	$I_{\text{NEG}} = 2 \text{ mA} / 20 \text{ mA} / 40 \text{ mA} - 40\text{mA Mode} - C_{\text{OUT}} = 2 \times 4.7 \mu\text{F}$	Figure 25
V_{POS} Output Ripple	Any load	Figure 26
LOAD TRANSIENT		
Load Transient	$V_{\text{IN}} = 2.9 \text{ V} - I_{\text{POS}} = -I_{\text{NEG}} = 5 \text{ mA} \rightarrow 35 \text{ mA} \rightarrow 5 \text{ mA} - 40\text{mA Mode} - L = 4.7 \mu\text{H}$	Figure 27
Load Transient	$V_{\text{IN}} = 3.7 \text{ V} - I_{\text{POS}} = -I_{\text{NEG}} = 5 \text{ mA} \rightarrow 35 \text{ mA} \rightarrow 5 \text{ mA} - 40\text{mA Mode} - L = 4.7 \mu\text{H}$	Figure 28
Load Transient	$V_{\text{IN}} = 4.5 \text{ V} - I_{\text{POS}} = -I_{\text{NEG}} = 5 \text{ mA} \rightarrow 35 \text{ mA} \rightarrow 5 \text{ mA} - 40\text{mA Mode} - L = 4.7 \mu\text{H}$	Figure 29
LINE TRANSIENT		
Line Transient	$V_{\text{IN}} = 2.8 \text{ V} \rightarrow 4.5 \text{ V} \rightarrow 2.8 \text{ V} - I_{\text{POS}} = -I_{\text{NEG}} = 0 \text{ mA} - 40\text{mA Mode} - L = 4.7 \mu\text{H}$	Figure 30
Line Transient	$V_{\text{IN}} = 2.8 \text{ V} \rightarrow 4.5 \text{ V} \rightarrow 2.8 \text{ V} - I_{\text{POS}} = -I_{\text{NEG}} = 5 \text{ mA} - 40\text{mA Mode} - L = 4.7 \mu\text{H}$	Figure 31
Line Transient	$V_{\text{IN}} = 2.8 \text{ V} \rightarrow 4.5 \text{ V} \rightarrow 2.8 \text{ V} - I_{\text{POS}} = -I_{\text{NEG}} = 35 \text{ mA} - 40\text{mA Mode} - L = 4.7 \mu\text{H}$	Figure 32

Table 12. Table Of Graphs (continued)

PARAMETER	CONDITIONS	Figure
POWER SEQUENCING		
Power-up Sequencing	Simultaneous — no load	Figure 33
Power-down Sequencing	Simultaneous — no load with Active Discharge	Figure 34
Power-up Sequencing	Sequential — no load	Figure 35
Power-down Sequencing	Sequential — no load with Active Discharge	Figure 36
Power-up/down Sequencing	Simultaneous — no load with Active Discharge	Figure 37
Power-up/down Sequencing	Simultaneous — no load without Active Discharge	Figure 38
INRUSH CURRENT		
Inrush Current	Simultaneous — no load — 40mA Mode	Figure 39
Inrush Current	Sequential — no load — 40mA Mode	Figure 40
Inrush Current	Simultaneous — no load — 40mA Mode — TPS65132B2, -Lx, -Sx, -Tx, -Wx	Figure 41
Inrush Current	Sequential — no load — 40mA Mode — TPS65132B2, -Lx, -Sx, -Tx, -Wx	Figure 42
LOAD REGULATION		
V _{POS} vs Output Current	V _{POS} = 5.0 V — 40mA Mode — I _{POS} = 0 mA to 40 mA — L = 4.7 μH and 2.2 μH	Figure 43
V _{POS} vs Output Current	V _{POS} = 5.4 V — 40mA Mode — I _{POS} = 0 mA to 40 mA — L = 4.7 μH and 2.2 μH	Figure 44
V _{NEG} vs Output Current	V _{NEG} = -5.0 V — 40mA Mode — I _{NEG} = 0 mA to 40 mA — L = 4.7 μH and 2.2 μH	Figure 45
V _{NEG} vs Output Current	V _{NEG} = -5.4 V — 40mA Mode — I _{NEG} = 0 mA to 40 mA — L = 4.7 μH and 2.2 μH	Figure 46
LINE REGULATION		
V _{POS} vs Output Voltage	V _{IN} = 2.5 V to 5.5 V — V _{POS} = 5.0 V — 40mA Mode — I _{POS} = 20 mA — L = 4.7 μH and 2.2 μH	Figure 47
V _{POS} vs Output Voltage	V _{IN} = 2.5 V to 5.5 V — V _{POS} = 5.4 V — 40mA Mode — I _{POS} = 20 mA — L = 4.7 μH and 2.2 μH	Figure 48
V _{NEG} vs Output Voltage	V _{IN} = 2.5 V to 5.5 V — V _{NEG} = -5.0 V — 40mA Mode — I _{NEG} = 20 mA — L = 4.7 μH and 2.2 μH	Figure 49
V _{NEG} vs Output Voltage	V _{IN} = 2.5 V to 5.5 V — V _{NEG} = -5.4 V — 40mA Mode — I _{NEG} = 20 mA — L = 4.7 μH and 2.2 μH	Figure 50

NOTE

In this section, I_{OUT} means that the outputs are loaded with I_{POS} = -I_{NEG} simultaneously.

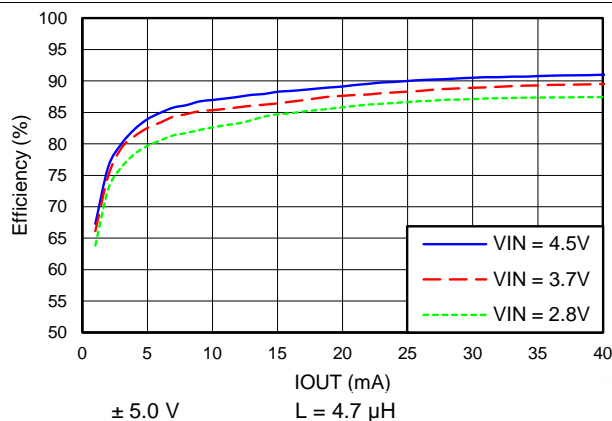

Figure 20. Combined Efficiency — 40mA Mode

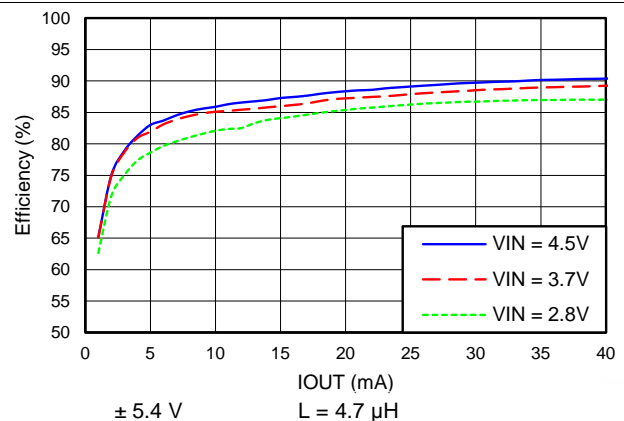

Figure 21. Combined Efficiency — 40mA Mode

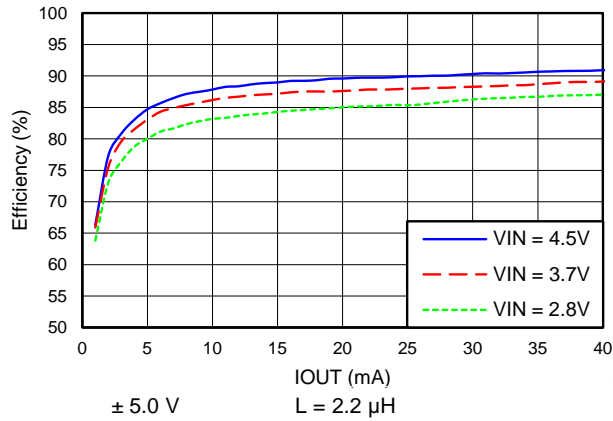

Figure 22. Combined Efficiency — 40mA Mode

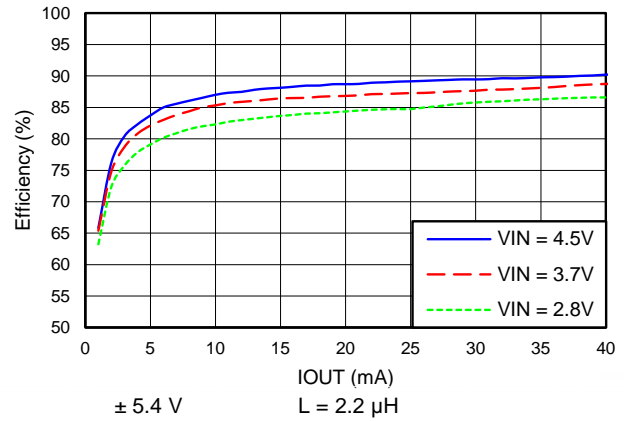

Figure 23. Combined Efficiency — 40mA Mode

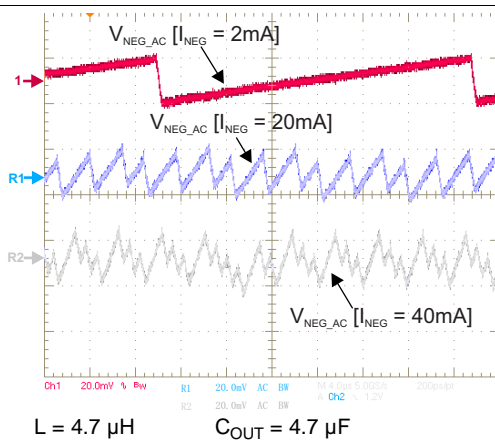

Figure 24. V_{NEG} Output Voltage Ripple — 40mA Mode

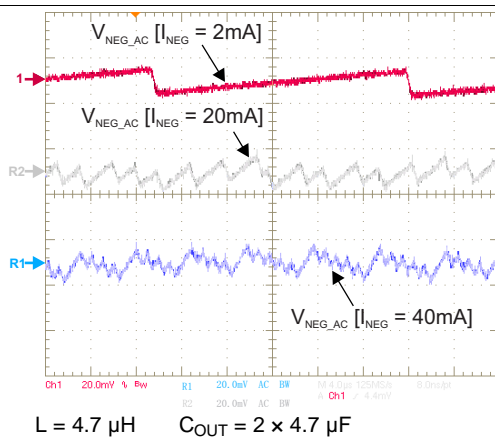

Figure 25. V_{NEG} Output Voltage Ripple — 40mA Mode

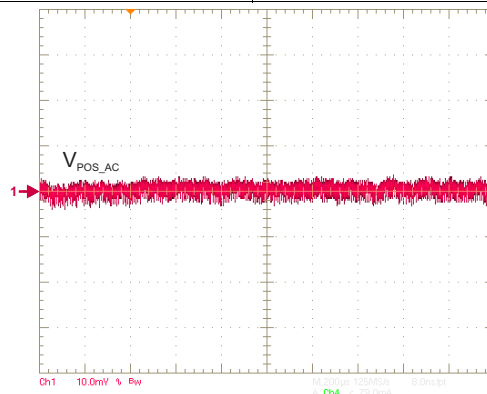

Figure 26. V_{POS} Output Voltage Ripple

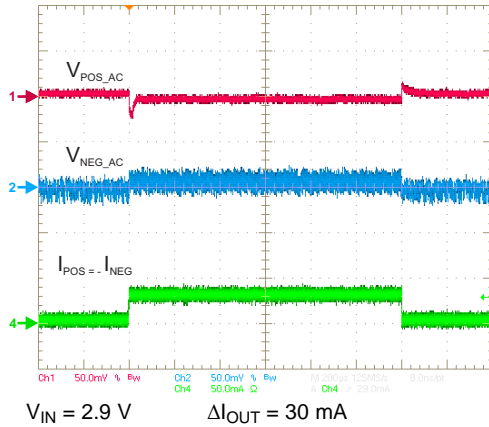

Figure 27. Load Transient — 40mA Mode

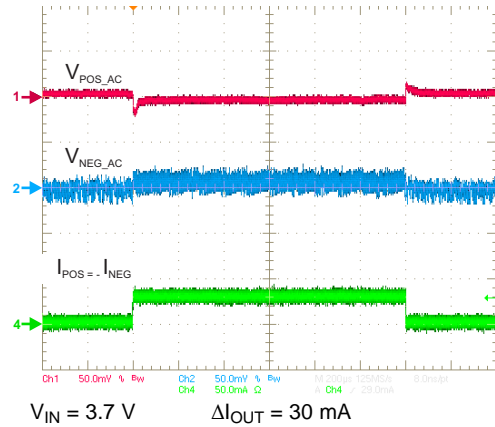

Figure 28. Load Transient — 40mA Mode

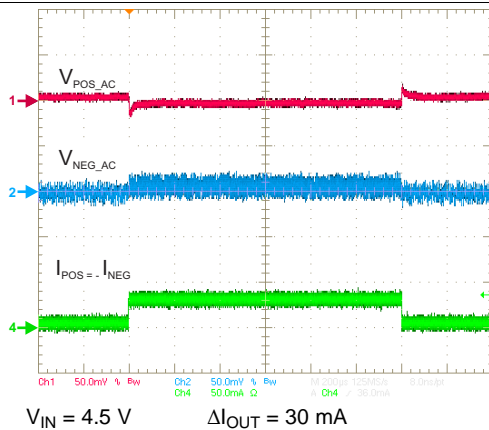

Figure 29. Load Transient — 40mA Mode

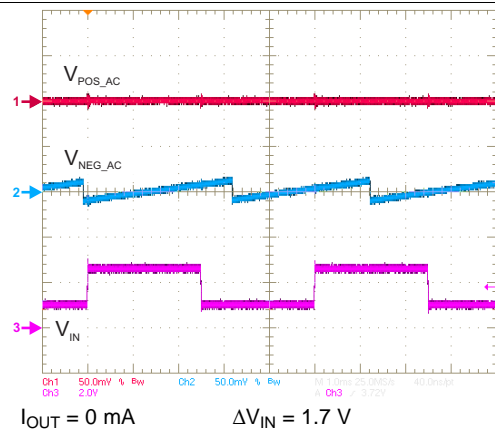

Figure 30. Line Transient — 40mA Mode

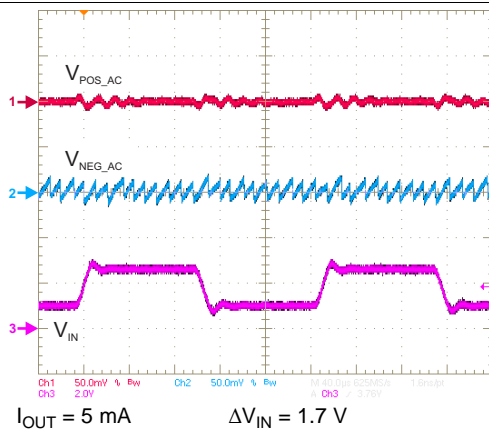

Figure 31. Line Transient — 40mA Mode

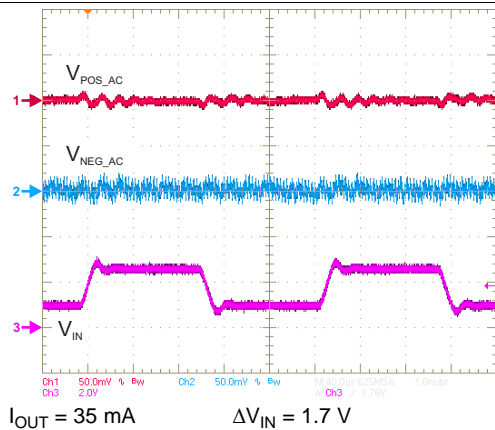

Figure 32. Line Transient — 40mA Mode

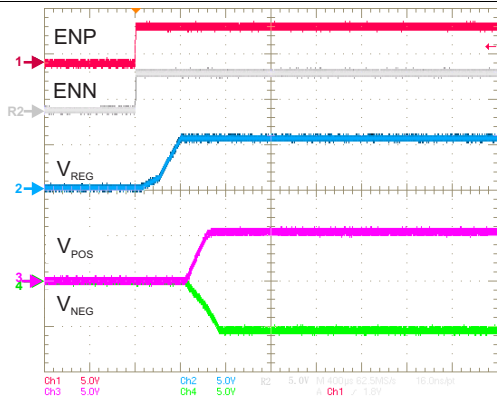

Figure 33. Power-Up Sequencing — Simultaneous

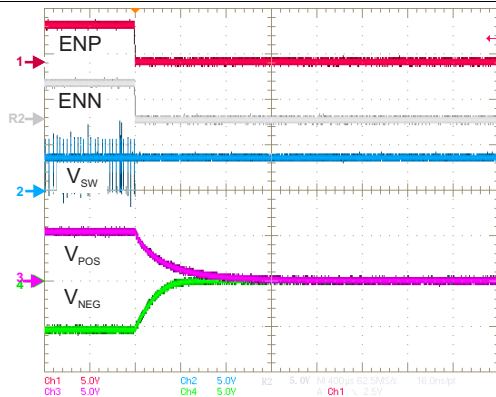

Figure 34. Power-Down Sequencing — Simultaneous (with Active Discharge)

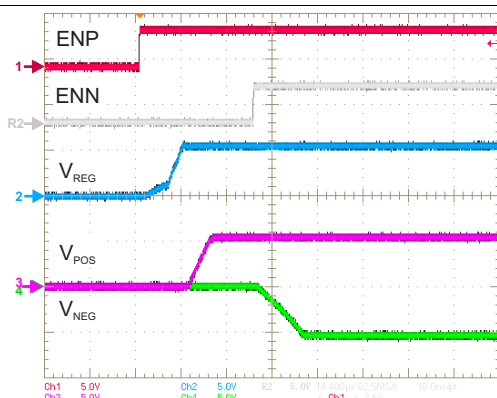

Figure 35. Power-Up Sequencing — Sequential

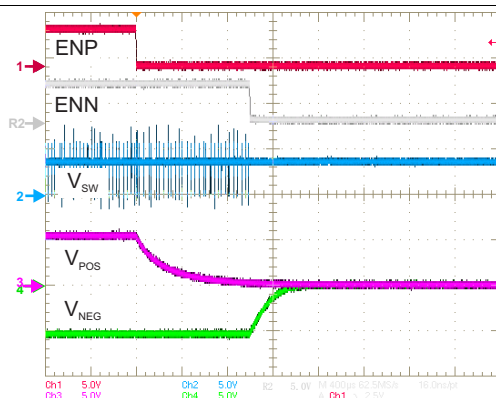

Figure 36. Power-Down Sequencing — Sequential (with Active Discharge)

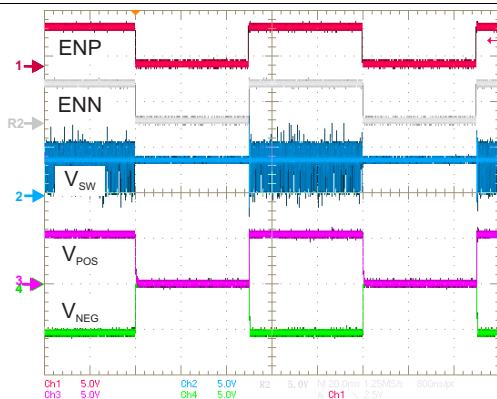

Figure 37. Power-Up/Down With Active Discharge

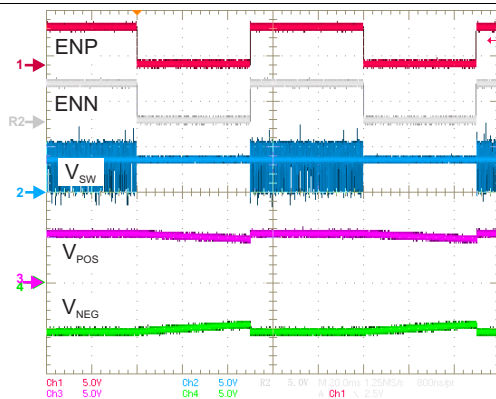

Figure 38. Power-Up/Down Without Active Discharge (TPS65132Ax only)

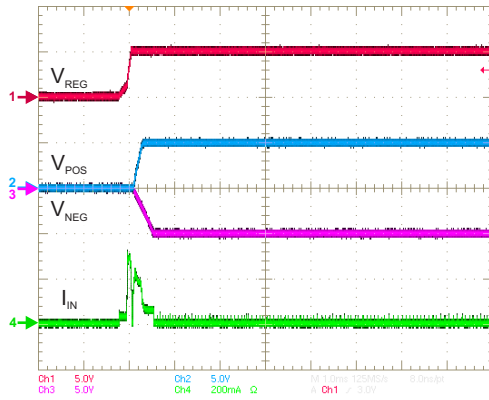

Figure 39. Inrush Current — Simultaneous

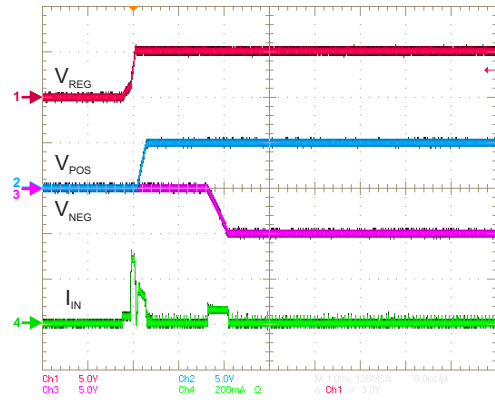

Figure 40. Inrush Current — Sequential

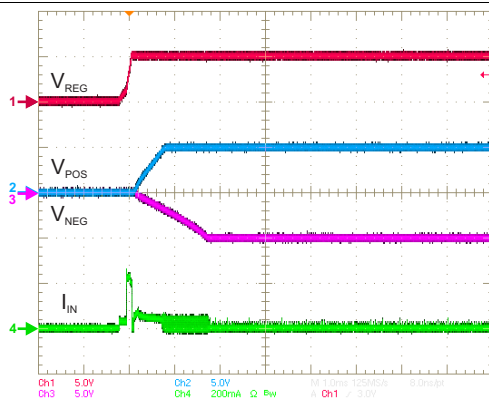

Figure 41. Inrush Current — Simultaneous (TPS65132B2, -Lx, -Sx, -Tx, -Wx)

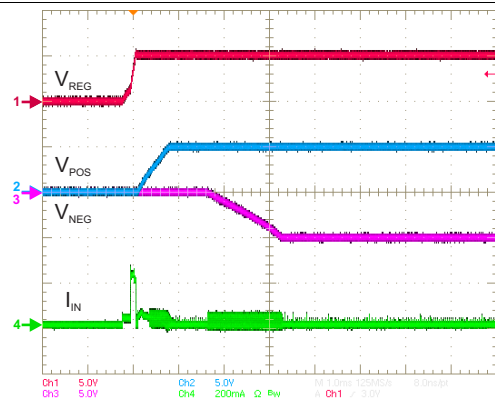

Figure 42. Inrush Current — Sequential (TPS65132B2, -Lx, -Sx, -Tx, -Wx)

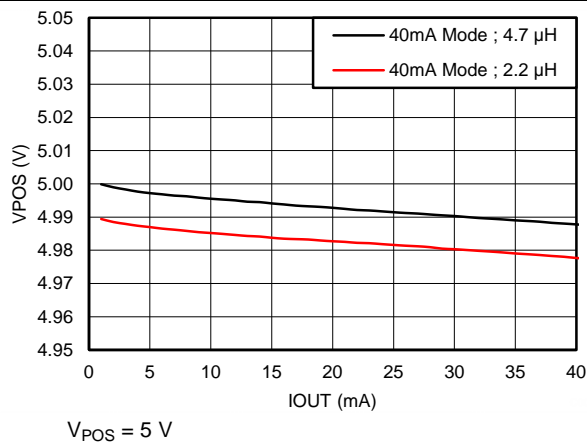

Figure 43. Load Regulation

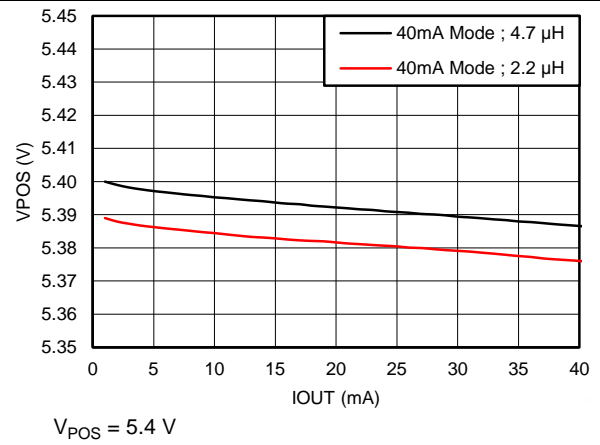

Figure 44. Load Regulation

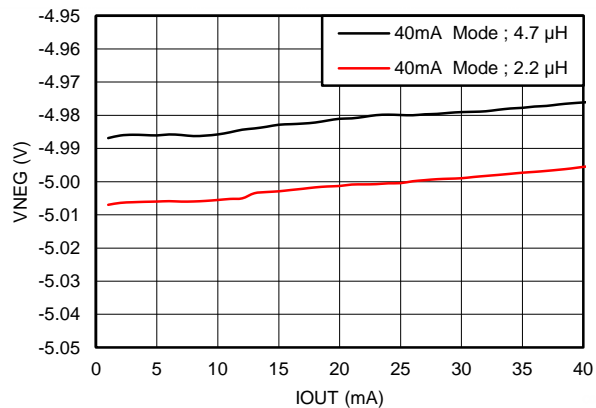

Figure 45. Load Regulation

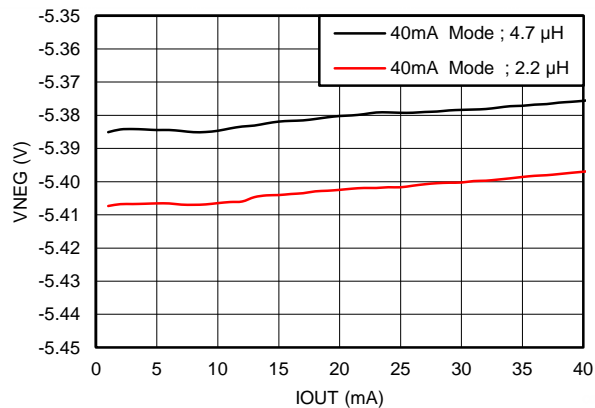

Figure 46. Load Regulation

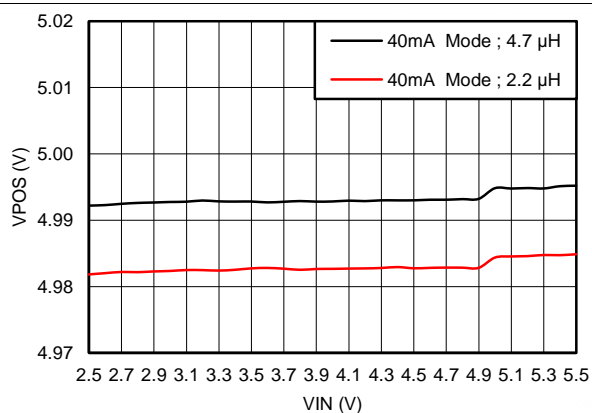

Figure 47. Line Regulation

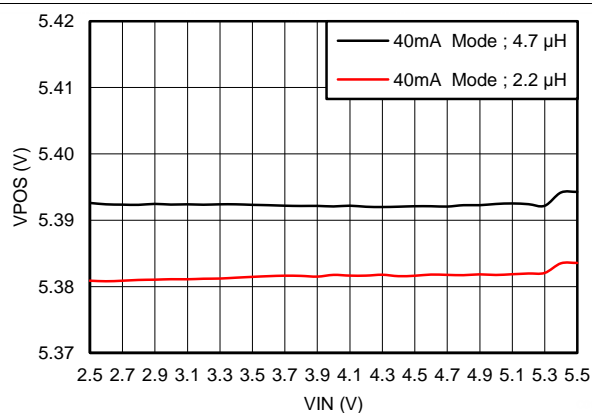

Figure 48. Line Regulation

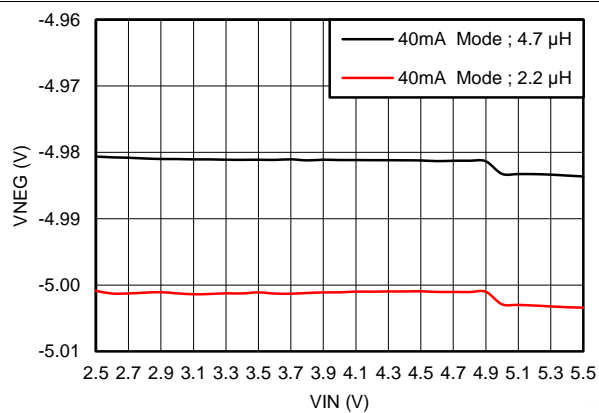

Figure 49. Line Regulation

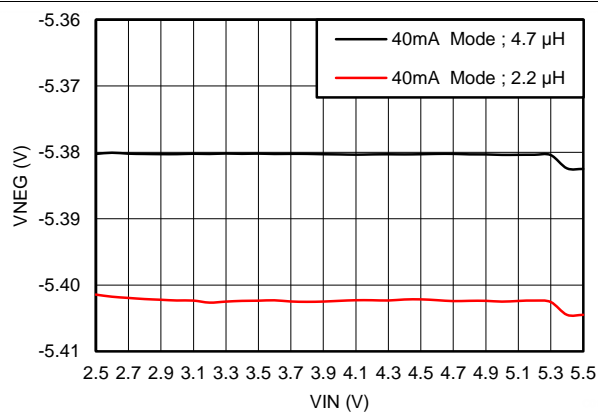

Figure 50. Line Regulation

9.2.2 Mid-current Applications (≤ 80 mA)

The TPS65132 can be programmed to 80mA mode with the APPS bit to support applications that require output currents up to 80 mA (refer to [Figure 17](#)). The 80mA mode is limiting the negative charge pump (CPN) output current to 80 mA DC in order to provide the highest efficiency possible where the $V_{(POS)}$ rail can deliver up to 200 mA DC regardless of the mode. Output peak currents are supported by the output capacitors.

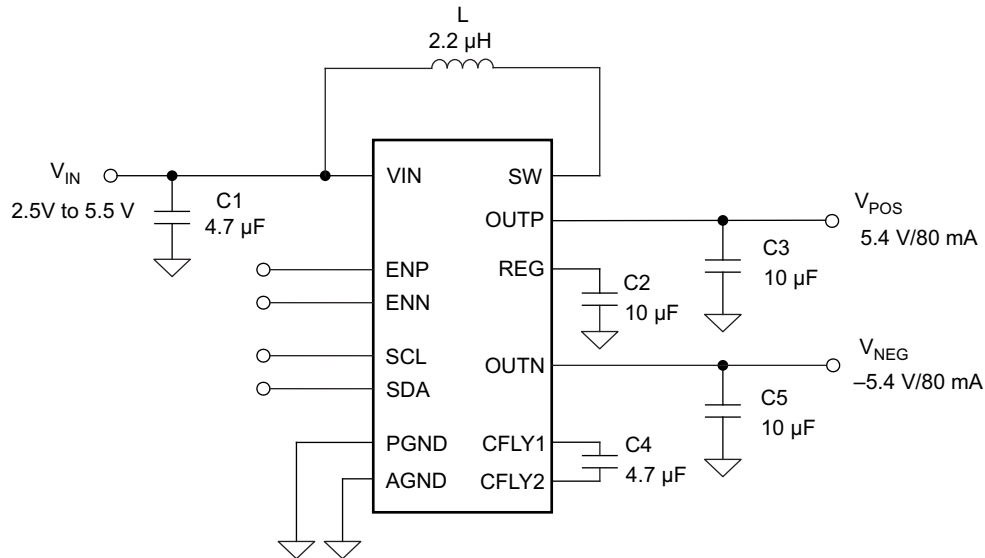

Figure 51. Typical Mid-current Application Circuit

9.2.2.1 Design Requirements

Table 13. Design Parameters

PARAMETERS	EXAMPLE VALUES
Input Voltage Range	2.5 V to 5.5 V
Output Voltages	4.0 V to 6.0 V, -4.0 V to -6.0 V
Output Current Rating	80 mA
Boost Converter Switching Frequency	1.8 MHz
Negative Charge Pump Switching Frequency	1.0 MHz

9.2.2.2 Detailed Design Procedure

The design procedure for the mid-current applications (80mA mode) is identical to the one for the low-current applications (40mA mode), except for the BOM (bill of materials). Refer to the [Detailed Design Procedure](#) for details about the sequencing and the general component selection.

9.2.2.2.1 Boost Converter Design Procedure

9.2.2.2.1.1 Inductor Selection (Boost Converter)

In order to keep the ratio $I_{OUT}/\Delta I_L$ low enough for proper sensing operation purpose, it is recommended to use a 2.2 μ H inductor for 80mA mode. For details, see [Inductor Selection \(Boost Converter\)](#).

9.2.2.2.1.2 Input Capacitor Selection (Boost Converter)

A 4.7 μ F minimum bypass capacitor is required as close as possible from VIN to GND. This capacitor is also used as the boost converter input capacitor.

For better input voltage filtering, this value can be increased or two capacitors can be used: one 4.7 μ F input capacitor for the boost converter as well as a 1 μ F bypass capacitor close to the VIN pin. Refer to the [Recommended Operating Conditions](#), [Table 10](#) and [Figure 51](#) for input capacitor recommendations.

9.2.2.2.1.3 Output Capacitor Selection (Boost Converter)

For best output voltage filtering low ESR ceramic capacitors are recommended. A minimum of 10 μF ceramic output capacitor is required. Higher capacitor values can be used to improve the load transient response. Refer to the [Recommended Operating Conditions, Table 10](#) and [Figure 51](#) for output capacitor recommendations.

9.2.2.2.2 Input Capacitor Selection (LDO)

The LDO input capacitor is also the boost converter output capacitor. Refer to the [Recommended Operating Conditions, Table 10](#) and [Figure 51](#).

9.2.2.2.3 Output Capacitor Selection (LDO)

The LDO is designed to operate with a 4.7 μF minimum ceramic output capacitor. Refer to the [Recommended Operating Conditions, Table 10](#) and [Figure 51](#).

9.2.2.2.4 Input Capacitor Selection (CPN)

The CPN input capacitor is also the boost converter output capacitor. Refer to the [Recommended Operating Conditions, Table 10](#) and [Figure 51](#).

9.2.2.2.5 Output Capacitor Selection (CPN)

The CPN is designed to operate with a 10 μF minimum ceramic output capacitor. Refer to the [Recommended Operating Conditions, Table 10](#) and [Figure 51](#).

9.2.2.2.6 Flying Capacitor Selection (CPN)

The CPN needs an external flying capacitor. The minimum value is 4.7 μF . Special care must be taken while choosing the flying capacitor as it will directly impact the output voltage accuracy and load regulation performance. Therefore, a minimum capacitance of 2.2 μF must be achieved by the capacitor at a DC bias voltage of $|V_{\text{NEG}}| + 300 \text{ mV}$. For proper operation, the flying capacitor value must be lower than the output capacitor of the boost converter on REG pin.

9.2.2.3 Application Curves

$V_{\text{IN}} = 3.7 \text{ V}$, $V_{\text{POS}} = 5.4 \text{ V}$, $V_{\text{NEG}} = -5.4 \text{ V}$, unless otherwise noted

Table 14. Component List For Typical Characteristics Circuits

REFERENCE	DESCRIPTION	MANUFACTURER AND PART NUMBER ⁽¹⁾
C	2.2 μF , 16 V, 0603, X5R, ceramic	Murata - GRM188R61C225KAAAD
	4.7 μF , 16 V, 0603, X5R, ceramic	Murata - GRM188R61C475KAAJ
	10 μF , 16 V, 0603, X5R, ceramic	Murata - GRM188R61E106MA73
L	2.2 μH , 2.4 A, 130 m Ω , 2.5 mm \times 2.0 mm \times 1.0 mm	Toko - DFE252010C (1269AS-H-2R2N=P2)
U1	TPS65132AYFF	Texas Instruments

(1) See [Third-Party Products Disclaimer](#)

Table 15. Table Of Graphs

PARAMETER	CONDITIONS	Figure
EFFICIENCY		
Efficiency vs. Output Current	$\pm 5.0\text{ V}$ — 80mA Mode — $L = 2.2\ \mu\text{H}$	Figure 52
Efficiency vs. Output Current	$\pm 5.4\text{ V}$ — 80mA Mode — $L = 2.2\ \mu\text{H}$	Figure 53
CONVERTERS WAVEFORMS		
V_{NEG} Output Ripple	$I_{\text{NEG}} = 4\text{ mA} / 40\text{ mA} / 80\text{ mA}$ — 80mA Mode — $C_{\text{OUT}} = 10\ \mu\text{F}$	Figure 54
V_{NEG} Output Ripple	$I_{\text{NEG}} = 4\text{ mA} / 40\text{ mA} / 80\text{ mA}$ — 80mA Mode — $C_{\text{OUT}} = 2 \times 10\ \mu\text{F}$	Figure 55
V_{POS} Output Ripple	$I_{\text{POS}} = 150\text{ mA}$ — 80mA Mode	Figure 56
LOAD TRANSIENT		
Load Transient	$V_{\text{IN}} = 2.9\text{ V}$ — $I_{\text{POS}} = -I_{\text{NEG}} = 10\text{ mA} \rightarrow 70\text{ mA} \rightarrow 10\text{ mA}$ — 80mA Mode — $L = 2.2\ \mu\text{H}$	Figure 57
Load Transient	$V_{\text{IN}} = 3.7\text{ V}$ — $I_{\text{POS}} = -I_{\text{NEG}} = 10\text{ mA} \rightarrow 70\text{ mA} \rightarrow 10\text{ mA}$ — 80mA Mode — $L = 2.2\ \mu\text{H}$	Figure 58
Load Transient	$V_{\text{IN}} = 4.5\text{ V}$ — $I_{\text{POS}} = -I_{\text{NEG}} = 10\text{ mA} \rightarrow 70\text{ mA} \rightarrow 10\text{ mA}$ — 80mA Mode — $L = 2.2\ \mu\text{H}$	Figure 59
LINE TRANSIENT		
Line Transient	$V_{\text{IN}} = 2.8\text{ V} \rightarrow 4.5\text{ V} \rightarrow 2.8\text{ V}$ — $I_{\text{POS}} = -I_{\text{NEG}} = 0\text{ mA}$ — 80mA Mode — $L = 2.2\ \mu\text{H}$	Figure 60
Line Transient	$V_{\text{IN}} = 2.8\text{ V} \rightarrow 4.5\text{ V} \rightarrow 2.8\text{ V}$ — $I_{\text{POS}} = -I_{\text{NEG}} = 40\text{ mA}$ — 80mA Mode — $L = 2.2\ \mu\text{H}$	Figure 61
Line Transient	$V_{\text{IN}} = 2.8\text{ V} \rightarrow 4.5\text{ V} \rightarrow 2.8\text{ V}$ — $I_{\text{POS}} = -I_{\text{NEG}} = 70\text{ mA}$ — 80mA Mode — $L = 2.2\ \mu\text{H}$	Figure 62
POWER SEQUENCING		
Power-up Sequencing	Simultaneous — no load	Figure 63
Power-down Sequencing	Simultaneous — no load with Active Discharge	Figure 64
Power-up Sequencing	Sequential — no load	Figure 65
Power-down Sequencing	Sequential — no load with Active Discharge	Figure 66
Power-up/down Sequencing	Simultaneous — no load with Active Discharge	Figure 67
Power-up/down Sequencing	Simultaneous — no load without Active Discharge	Figure 68
INRUSH CURRENT		
Inrush Current	Simultaneous — no load — 80mA Mode	Figure 69
Inrush Current	Sequential — no load — 80mA Mode	Figure 70
Inrush Current	Simultaneous — no load — 80mA Mode — TPS65132B2, -Lx, -Sx, -Tx, -Wx	Figure 71
Inrush Current	Sequential — no load — 80mA Mode — TPS65132B2, -Lx, -Sx, -Tx, -Wx	Figure 72
LOAD REGULATION		
V_{POS} vs Output Current	$V_{\text{POS}} = 5.0\text{ V}$ — 80mA Mode — $I_{\text{POS}} = 0\text{ mA}$ to 80 mA — $L = 2.2\ \mu\text{H}$	Figure 73
V_{POS} vs Output Current	$V_{\text{POS}} = 5.4\text{ V}$ — 80mA Mode — $I_{\text{POS}} = 0\text{ mA}$ to 80 mA — $L = 2.2\ \mu\text{H}$	Figure 74
V_{NEG} vs Output Current	$V_{\text{NEG}} = -5.0\text{ V}$ — 80mA Mode — $I_{\text{NEG}} = 0\text{ mA}$ to 80 mA — $L = 2.2\ \mu\text{H}$	Figure 75
V_{NEG} vs Output Current	$V_{\text{NEG}} = -5.4\text{ V}$ — 80mA Mode — $I_{\text{NEG}} = 0\text{ mA}$ to 80 mA — $L = 2.2\ \mu\text{H}$	Figure 76
LINE REGULATION		
V_{POS} vs Output Voltage	$V_{\text{IN}} = 2.5\text{ V}$ to 5.5 V — $V_{\text{POS}} = 5.0\text{ V}$ — 80mA Mode — $I_{\text{POS}} = 60\text{ mA}$ — $L = 2.2\ \mu\text{H}$	Figure 77
V_{POS} vs Output Voltage	$V_{\text{IN}} = 2.5\text{ V}$ to 5.5 V — $V_{\text{POS}} = 5.4\text{ V}$ — 80mA Mode — $I_{\text{POS}} = 60\text{ mA}$ — $L = 2.2\ \mu\text{H}$	Figure 78
V_{NEG} vs Output Voltage	$V_{\text{IN}} = 2.5\text{ V}$ to 5.5 V — $V_{\text{NEG}} = -5.0\text{ V}$ — 80mA Mode — $I_{\text{NEG}} = 60\text{ mA}$ — $L = 2.2\ \mu\text{H}$	Figure 79
V_{NEG} vs Output Voltage	$V_{\text{IN}} = 2.5\text{ V}$ to 5.5 V — $V_{\text{NEG}} = -5.4\text{ V}$ — 80mA Mode — $I_{\text{NEG}} = 60\text{ mA}$ — $L = 2.2\ \mu\text{H}$	Figure 80

NOTE

In this section, I_{OUT} means that the outputs are loaded with $I_{\text{POS}} = -I_{\text{NEG}}$ simultaneously.

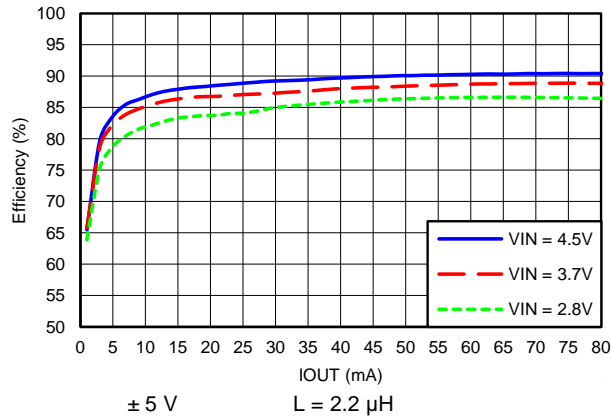

Figure 52. Combined Efficiency — 80mA Mode

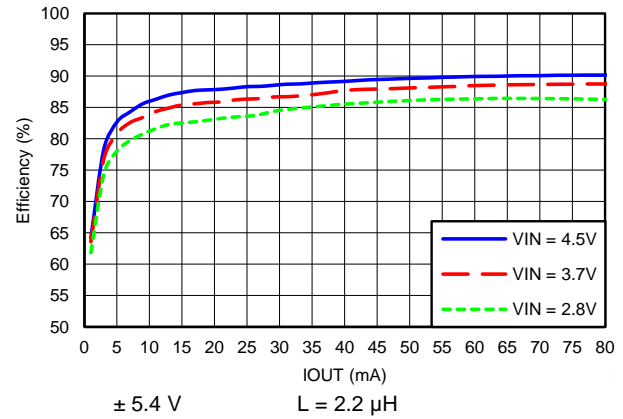

Figure 53. Combined Efficiency — 80mA Mode

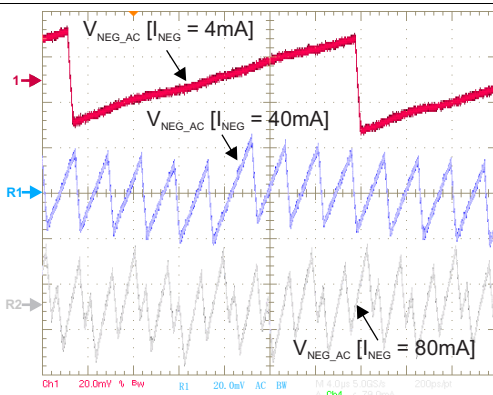

Figure 54. V_{NEG} Output Voltage Ripple — 80mA Mode

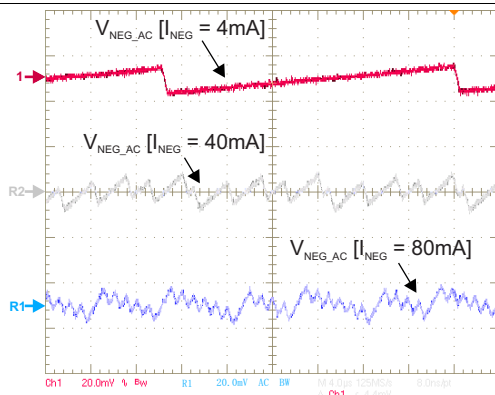

Figure 55. V_{NEG} Output Voltage Ripple — 80mA Mode

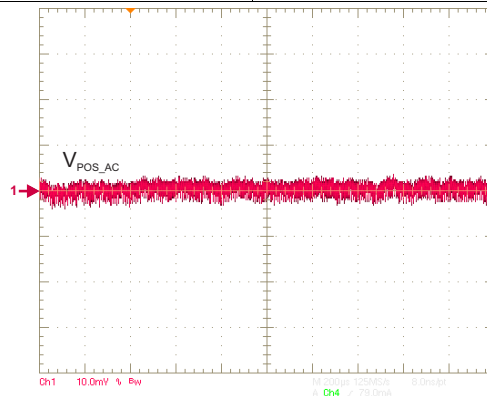

Figure 56. V_{POS} Output Voltage Ripple

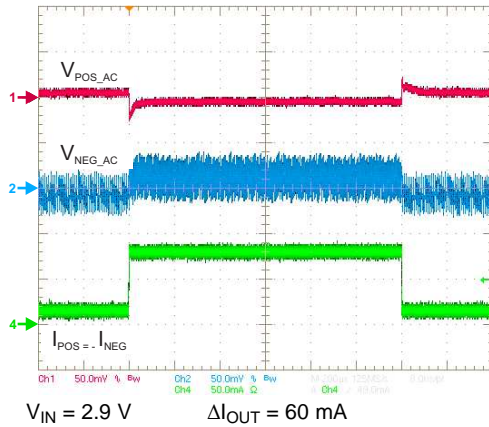

Figure 57. Load Transient — 80mA Mode

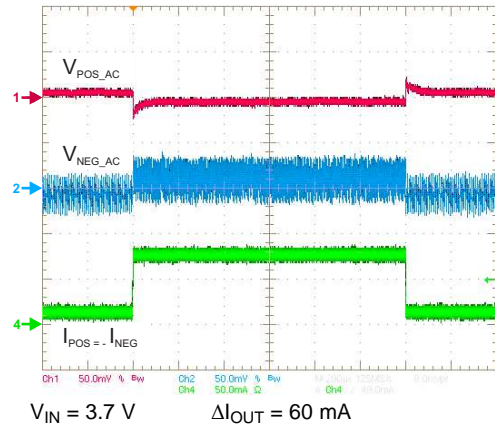

Figure 58. Load Transient — 80mA Mode

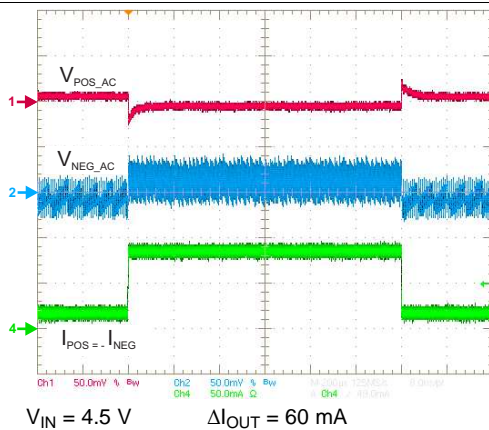

Figure 59. Load Transient — 80mA Mode

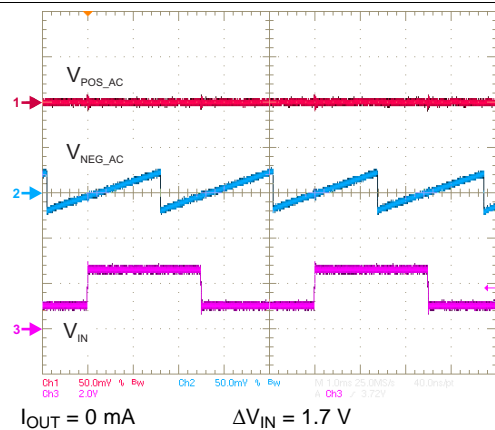

Figure 60. Line Transient — 80mA Mode

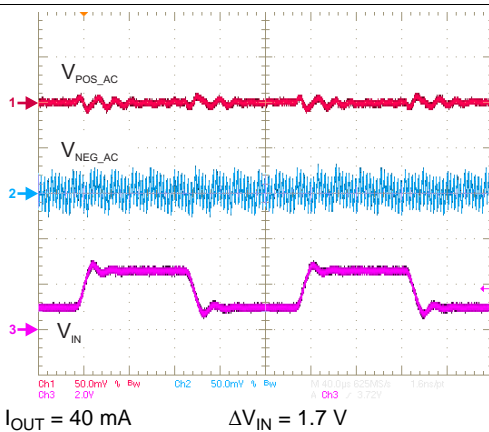

Figure 61. Line Transient — 80mA Mode

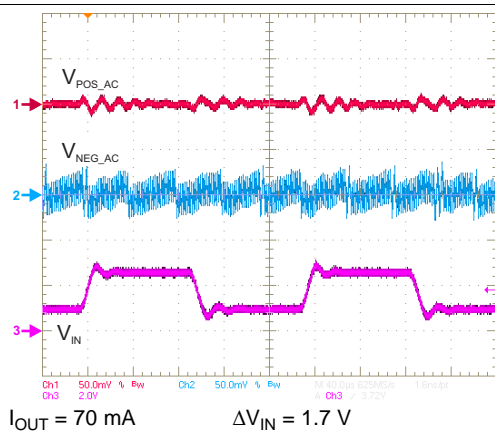

Figure 62. Line Transient — 80mA Mode

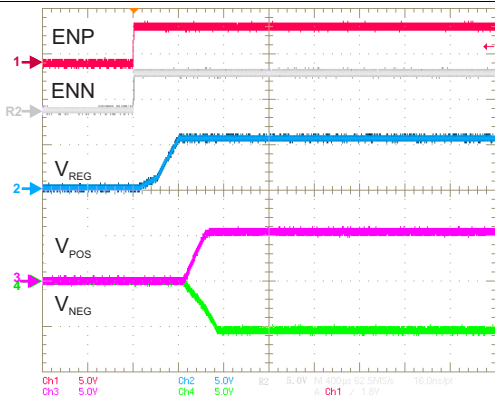

Figure 63. Power-Up Sequencing — Simultaneous

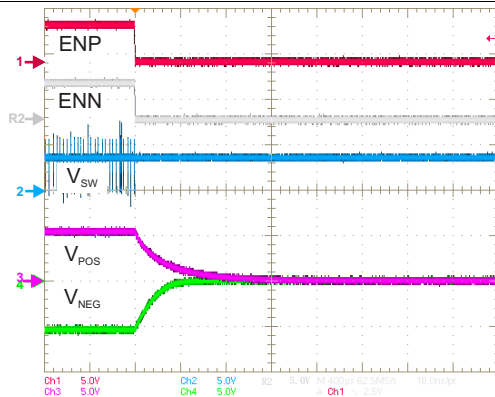

Figure 64. Power-Down Sequencing — Simultaneous (with Active Discharge)

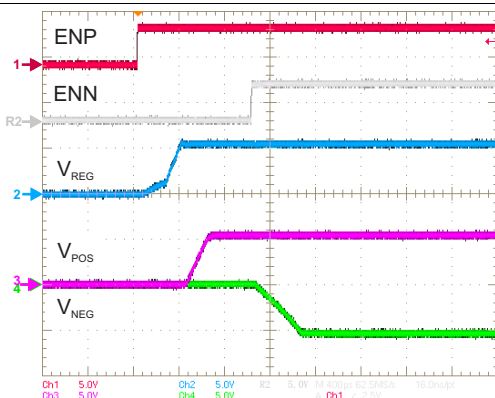

Figure 65. Power-Up Sequencing — Sequential

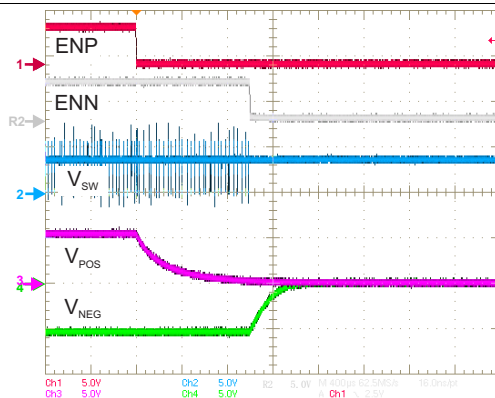

Figure 66. Power-Down Sequencing — Sequential (with Active Discharge)

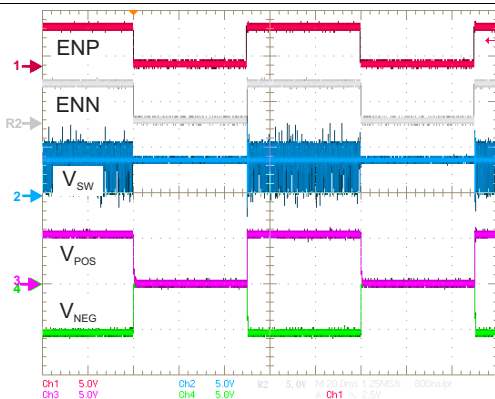

Figure 67. Power-Up/Down With Active Discharge

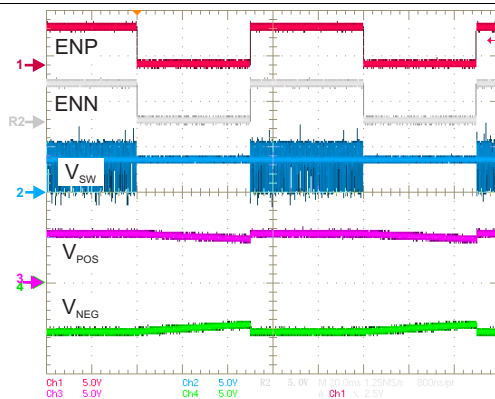

Figure 68. Power-Up/Down Without Active Discharge (TPS65132Ax only)

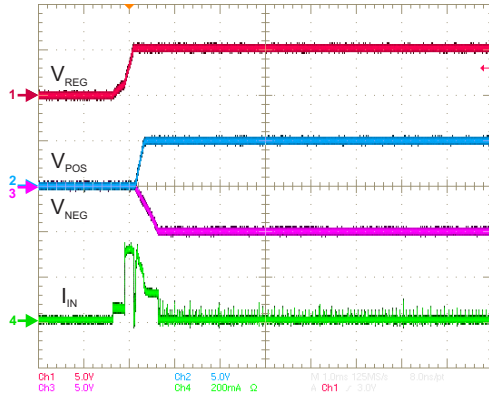

Figure 69. Inrush Current — Simultaneous

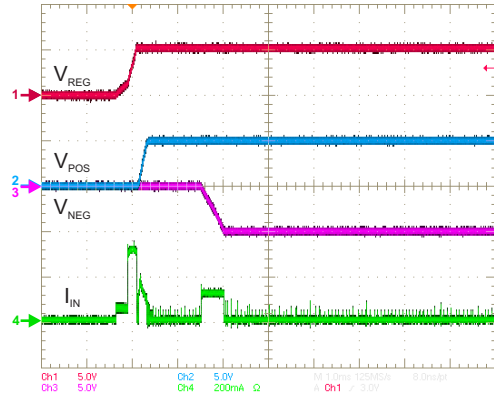

Figure 70. Inrush Current — Sequential

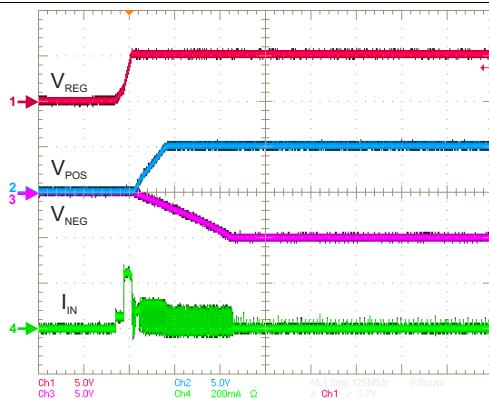

Figure 71. Inrush Current — Simultaneous (TPS65132B2, -Lx, -Sx, -Wx)

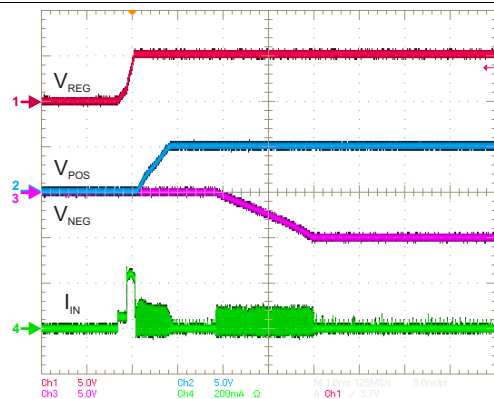

Figure 72. Inrush Current — Sequential (TPS65132B2, -Lx, -Sx, -Wx)

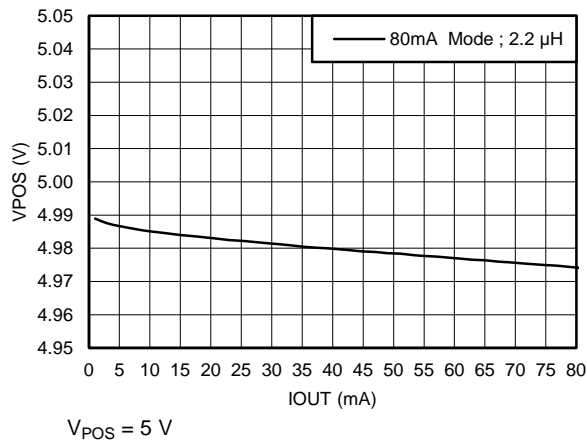

Figure 73. Load Regulation

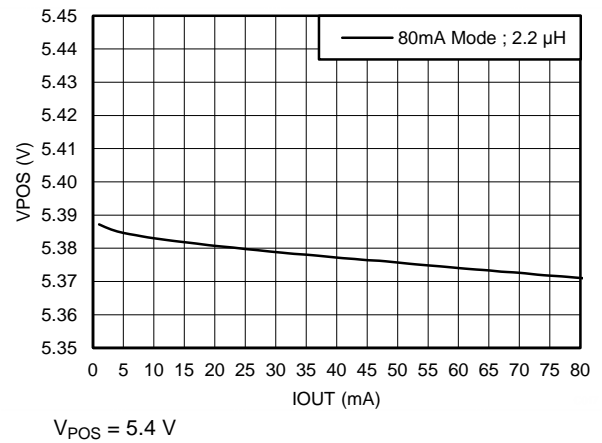

Figure 74. Load Regulation

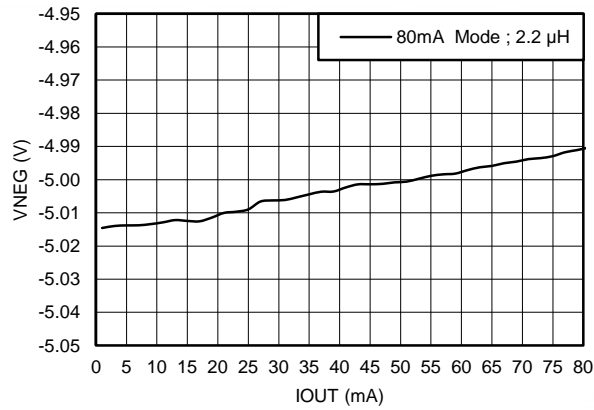

Figure 75. Load Regulation

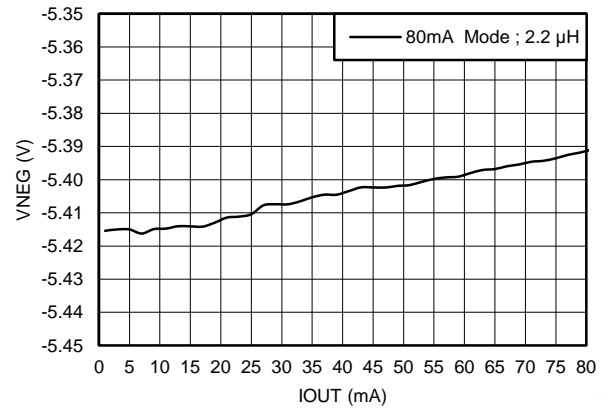

Figure 76. Load Regulation

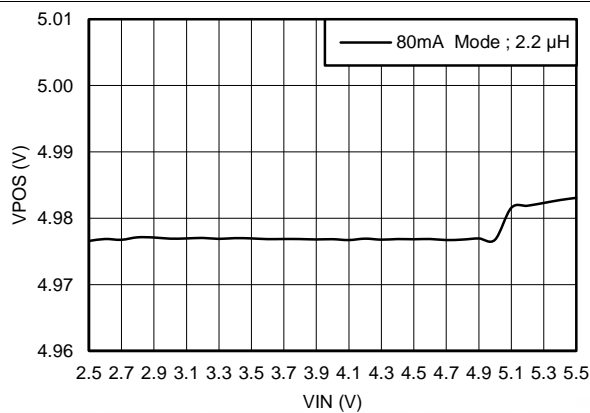

Figure 77. Line Regulation

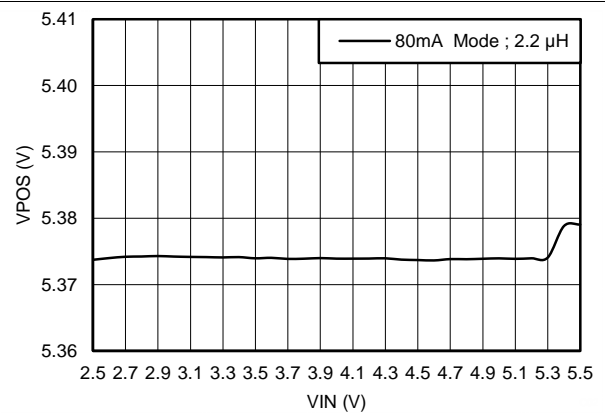

Figure 78. Line Regulation

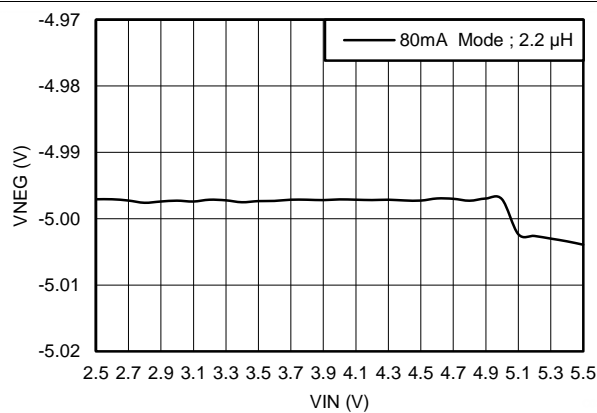

Figure 79. Line Regulation

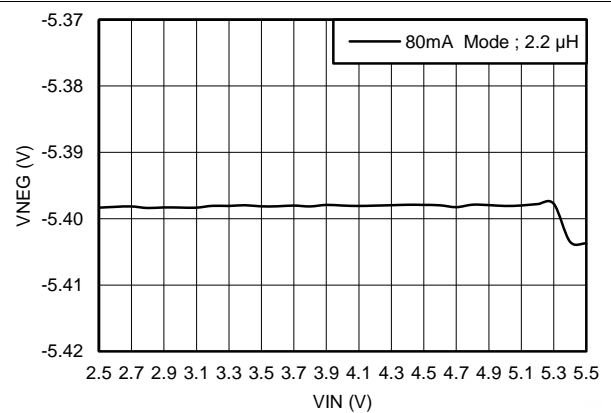

Figure 80. Line Regulation

9.2.3 High-current Applications (≤ 150 mA)

The TPS65132Sx version allows output current up to 150 mA on both V_{POS} and V_{NEG} when the SYNC pin is pulled HIGH. If the SYNC pin is pulled LOW, the TPS65132Sx can be programmed to 40mA or 80mA mode with the APPS bit to lower the output current capability of the V_{NEG} rail if needed (in the case the efficiency is an important parameter). See [Low-current Applications \(\$\leq 40\$ mA\)](#) and [Mid-current Applications \(\$\leq 80\$ mA\)](#) for more details about the 40mA and 80mA modes.

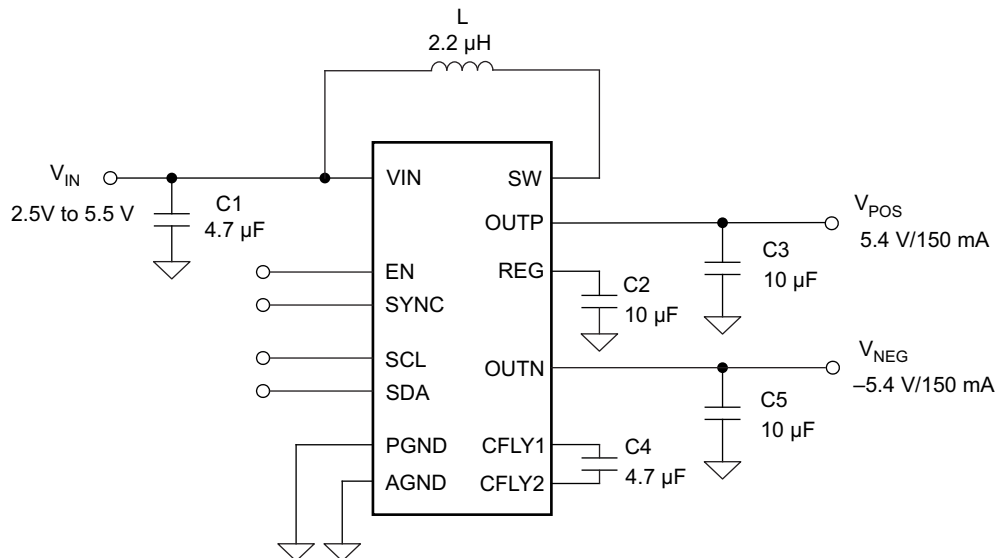

Figure 81. Typical Application Circuit For High Current

9.2.3.1 Design Requirements

Table 16. Design Parameters

PARAMETERS	EXAMPLE VALUES
Input Voltage Range	2.5 V to 5.5 V
Output Voltages	4.0 V to 6.0 V, -4.0 V to -6.0 V
Output Current Rating	150 mA
Boost Converter Switching Frequency	1.8 MHz
Negative Charge Pump Switching Frequency	1.0 MHz

9.2.3.2 Detailed Design Procedure

The design procedure and BOM list of the TPS65132Sx is identical to the 80mA mode. Please refer to the [Mid-current Applications \(\$\leq 80\$ mA\)](#) for more details about the general component selection.

9.2.3.2.1 Sequencing

The output rails (V_{POS} and V_{NEG}) are enabled and disabled using an external logic signal on the EN pin. The power-up and power-down sequencing events are programmable. Please refer to [Programmable Sequencing Scenarios](#) for the different sequencing as well as [Registers](#) for the programming options. [Figure 98](#) to [Figure 103](#) show the typical sequencing waveforms.

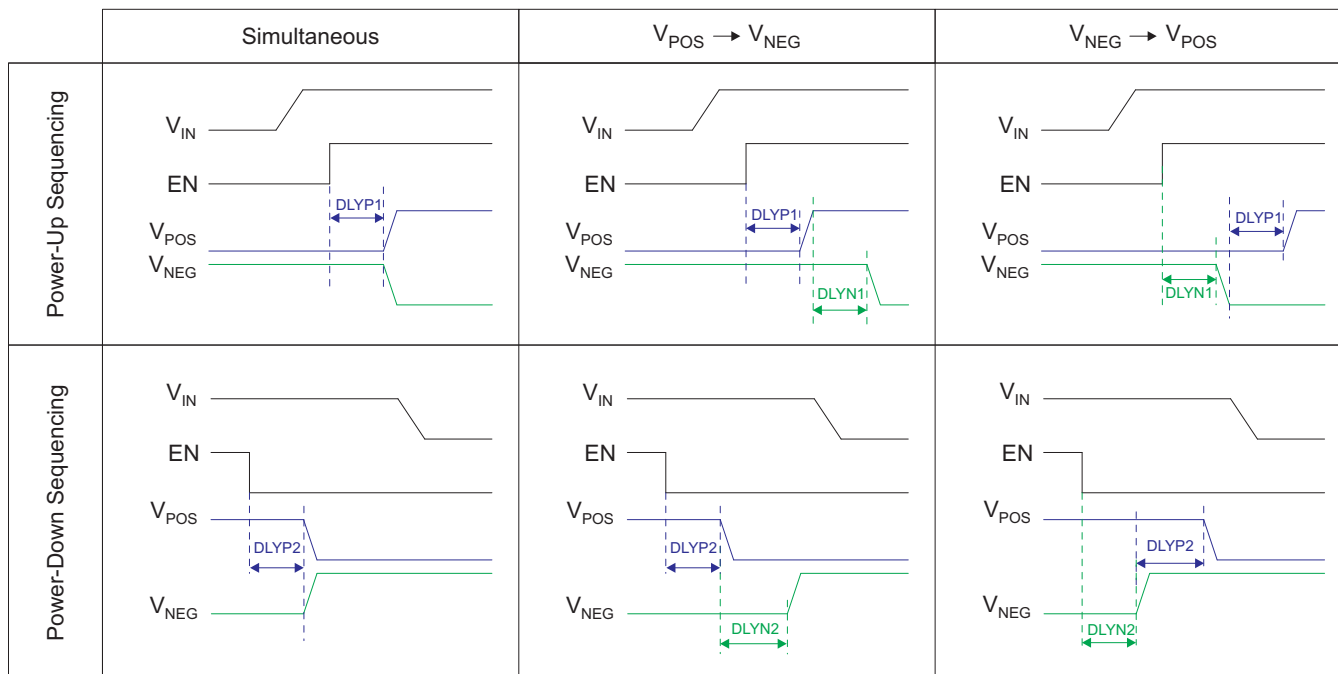

Figure 82. Programmable Sequencing Scenarios

NOTE

- In the case where the UVLO falling threshold is triggered while the enable signal is still HIGH (EN), all converters will be shut down instantaneously and both V_{POS} and V_{NEG} output rails will be actively discharged to GND.
- The power-up and power-down sequencing must be finalized (all delays have passed) before re-toggling the EN pin.

9.2.3.2.2 SYNC = HIGH

When the SYNC pin is pulled HIGH, the boost converter voltage increases instantaneously to allow enough headroom to deliver the 150 mA. See [Figure 88](#) to [Figure 91](#) for detailed waveforms.

When SYNC pin is pulled LOW, the boost converter keeps its offset for 300 μ s typically, and during this time, the device is still capable of supplying 150 mA on both output rail. After these 300 μ s have passed, current limit settles at 40 mA or 80 mA maximum, depending on the application mode it is programmed to (40mA or 80mA — see [Low-current Applications \(\$\leq 40\$ mA\)](#) and [Mid-current Applications \(\$\leq 80\$ mA\)](#) for more details) and the boost output voltage regulates down to its nominal value.

9.2.3.2.3 Startup

The TPS65132Sx can startup with SYNC = HIGH, however, the boost offset as well as the 150 mA output current capability will only be available as soon as the last rail to start is in regulation.

9.2.3.3 Application Curves

 $V_{IN} = 3.7\text{ V}$, $V_{POS} = 5.4\text{ V}$, $V_{NEG} = -5.4\text{ V}$, unless otherwise noted

Table 17. Component List For Typical Characteristics Circuits

REFERENCE	DESCRIPTION	MANUFACTURER AND PART NUMBER
C	2.2 μF , 16 V, 0603, X5R, ceramic	Murata - GRM188R61C225KAAD
	4.7 μF , 16 V, 0603, X5R, ceramic	Murata - GRM188R61C475KAAJ
	10 μF , 16 V, 0603, X5R, ceramic	Murata - GRM188R61E106MA73
L	2.2 μH , 2.4 A, 130 m Ω , 2.5 mm \times 2.0 mm \times 1.0 mm	Toko - DFE252010C (1269AS-H-2R2N=P2)
U1	TPS65132SYFF	Texas Instruments

Table 18. Table Of Graphs

PARAMETER	CONDITIONS	Figure
EFFICIENCY		
Efficiency vs. Output Current	$\pm 5.0\text{ V}$ — SYNC = HIGH — L = 2.2 μH	Figure 83
Efficiency vs. Output Current	$\pm 5.4\text{ V}$ — SYNC = HIGH — L = 2.2 μH	Figure 84
CONVERTERS WAVEFORMS		
V_{POS} Output Ripple	$I_{POS} = 150\text{ mA}$ — SYNC = HIGH	Figure 85
V_{NEG} Output Ripple	$I_{NEG} = 10\text{ mA} / 80\text{ mA} / 150\text{ mA}$ — SYNC = HIGH — $C_{OUT} = 10\text{ }\mu\text{F}$	Figure 86
V_{NEG} Output Ripple	$I_{NEG} = 4\text{ mA} / 40\text{ mA} / 80\text{ mA}$ — SYNC = HIGH — $C_{OUT} = 2 \times 10\text{ }\mu\text{F}$	Figure 87
SYNC = HIGH Signal		
SYNC = HIGH	$I_{POS} = -I_{NEG} = 10\text{ mA}$	Figure 88
SYNC = HIGH	$I_{POS} = -I_{NEG} = 150\text{ mA}$	Figure 89
SYNC = HIGH Zoom	$I_{POS} = -I_{NEG} = 10\text{ mA}$	Figure 90
SYNC = LOW Zoom	$I_{POS} = -I_{NEG} = 10\text{ mA}$	Figure 91
LOAD TRANSIENT		
Load Transient	$V_{IN} = 2.9\text{ V}$ — $I_{POS} = -I_{NEG} = 10\text{ mA} \rightarrow 150\text{ mA} \rightarrow 10\text{ mA}$ — SYNC = HIGH — L = 2.2 μH	Figure 92
Load Transient	$V_{IN} = 3.7\text{ V}$ — $I_{POS} = -I_{NEG} = 10\text{ mA} \rightarrow 150\text{ mA} \rightarrow 10\text{ mA}$ — SYNC = HIGH — L = 2.2 μH	Figure 93
Load Transient	$V_{IN} = 4.5\text{ V}$ — $I_{POS} = -I_{NEG} = 10\text{ mA} \rightarrow 150\text{ mA} \rightarrow 10\text{ mA}$ — SYNC = HIGH — L = 2.2 μH	Figure 94
LINE TRANSIENT		
Line Transient	$V_{IN} = 2.8\text{ V} \rightarrow 4.5\text{ V} \rightarrow 2.8\text{ V}$ — $I_{POS} = -I_{NEG} = 10\text{ mA}$ — SYNC = HIGH — L = 2.2 μH	Figure 95
Line Transient	$V_{IN} = 2.8\text{ V} \rightarrow 4.5\text{ V} \rightarrow 2.8\text{ V}$ — $I_{POS} = -I_{NEG} = 100\text{ mA}$ — SYNC = HIGH — L = 2.2 μH	Figure 96
Line Transient	$V_{IN} = 2.8\text{ V} \rightarrow 4.5\text{ V} \rightarrow 2.8\text{ V}$ — $I_{POS} = -I_{NEG} = 150\text{ mA}$ — SYNC = HIGH — L = 2.2 μH	Figure 97
POWER SEQUENCING		
Power-up Sequencing	Simultaneous — no load	Figure 98
Power-down Sequencing	Simultaneous — no load with Active Discharge	Figure 99
Power-up Sequencing	Sequential ($V_{POS} \rightarrow V_{NEG}$) — no load	Figure 100
Power-down Sequencing	Sequential ($V_{NEG} \rightarrow V_{POS}$) — no load with Active Discharge	Figure 101
Power-up Sequencing	Sequential ($V_{NEG} \rightarrow V_{POS}$) — no load	Figure 102
Power-down Sequencing	Sequential ($V_{POS} \rightarrow V_{NEG}$) — no load with Active Discharge	Figure 103

Table 18. Table Of Graphs (continued)

PARAMETER	CONDITIONS	Figure
Power-up/down Sequencing	Simultaneous — no load without Active Discharge	Figure 104
Power-up/down Sequencing	Simultaneous — no load with Active Discharge	Figure 105
INRUSH CURRENT		
Inrush Current	Simultaneous — no load — SYNC = HIGH — L = 2.2 μ H	Figure 106
Inrush Current	Sequential — no load — SYNC = HIGH — L = 2.2 μ H	Figure 107
LOAD REGULATION		
V _{POS} vs Output Current	V _{POS} = 5.0 V — SYNC = HIGH — I _{POS} = 0 mA to 150 mA — L = 2.2 μ H	Figure 108
V _{POS} vs Output Current	V _{POS} = 5.4 V — SYNC = HIGH — I _{POS} = 0 mA to 150 mA — L = 2.2 μ H	Figure 109
V _{NEG} vs Output Current	V _{NEG} = -5.0 V — SYNC = HIGH — I _{NEG} = 0 mA to 150 mA — L = 2.2 μ H	Figure 110
V _{NEG} vs Output Current	V _{NEG} = -5.4 V — SYNC = HIGH — I _{NEG} = 0 mA to 150 mA — L = 2.2 μ H	Figure 111
LINE REGULATION		
V _{POS} vs Output Voltage	V _{IN} = 2.5 V to 5.5 V — V _{POS} = 5.0 V — SYNC = HIGH — I _{POS} = 120 mA — L = 2.2 μ H	Figure 112
V _{POS} vs Output Voltage	V _{IN} = 2.5 V to 5.5 V — V _{POS} = 5.4 V — SYNC = HIGH — I _{POS} = 120 mA — L = 2.2 μ H	Figure 113
V _{NEG} vs Output Voltage	V _{IN} = 2.5 V to 5.5 V — V _{NEG} = -5.0 V — SYNC = HIGH — I _{NEG} = 120 mA — L = 2.2 μ H	Figure 114
V _{NEG} vs Output Voltage	V _{IN} = 2.5 V to 5.5 V — V _{NEG} = -5.4 V — SYNC = HIGH — I _{NEG} = 120 mA — L = 2.2 μ H	Figure 115

NOTE

In this section, I_{OUT} means that the outputs are loaded with I_{POS} = -I_{NEG} simultaneously.

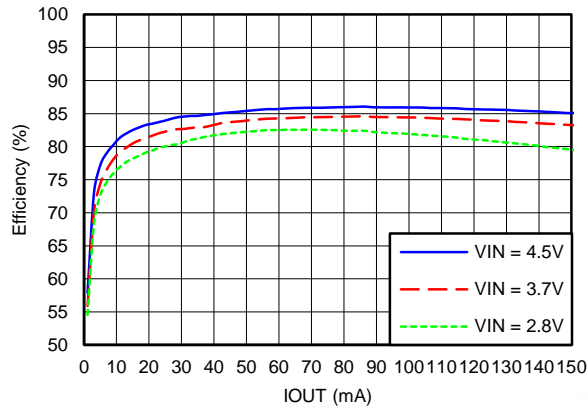

Figure 83. Combined Efficiency — ± 5.0 V — SYNC = HIGH
L = 2.2 μ H

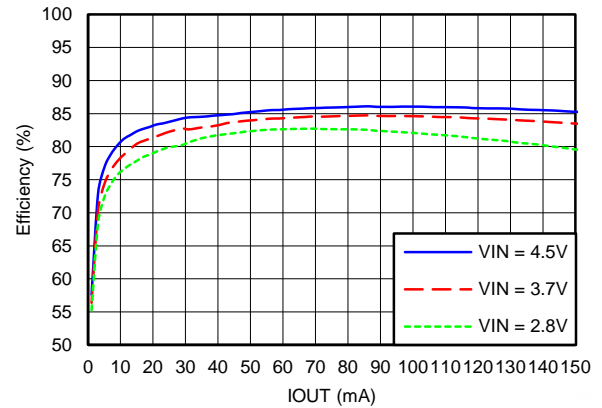

Figure 84. Combined Efficiency — ± 5.4 V — SYNC = HIGH
L = 2.2 μ H

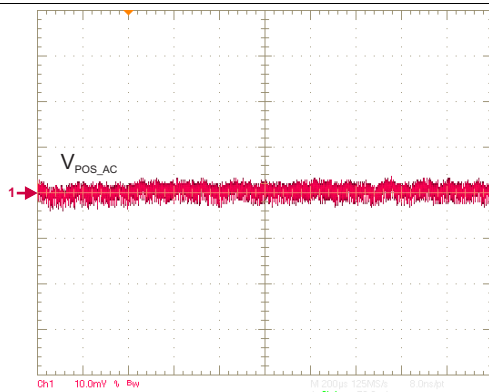

Figure 85. V_{POS} Output Voltage Ripple — SYNC = HIGH

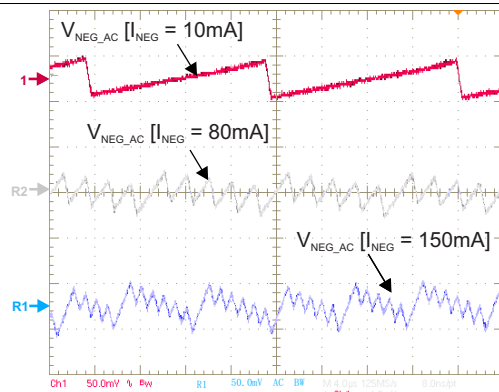

Figure 86. V_{NEG} Output Voltage Ripple — SYNC = HIGH —
L = 2.2 μ H — C_{OUT} = 10 μ F

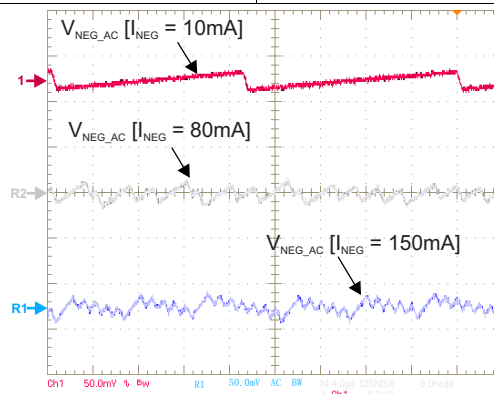

Figure 87. V_{NEG} Output Voltage Ripple — SYNC = HIGH —
L = 2.2 μ H — C_{OUT} = 2 × 10 μ F

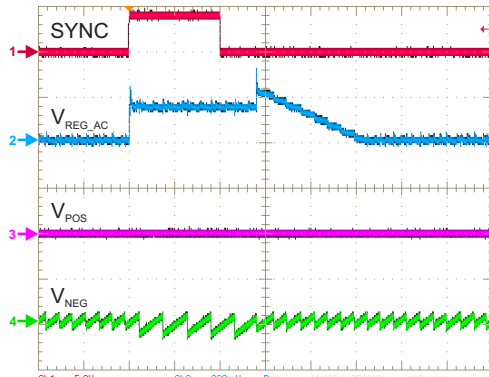

Figure 88. SYNC Signal — $I_{OUT} = 10 \text{ mA}$

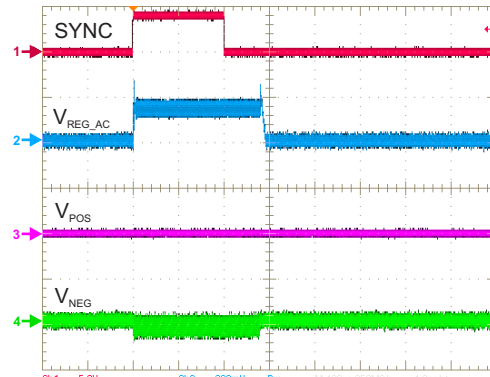

Figure 89. SYNC Signal — $I_{OUT} = 150 \text{ mA}$

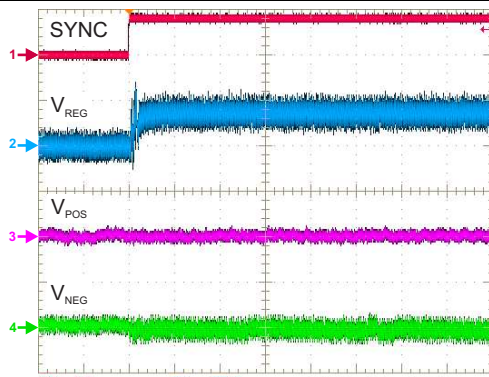

Figure 90. SYNC = HIGH (zoom)

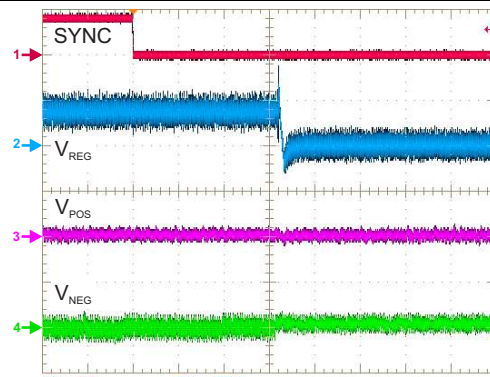

Figure 91. SYNC = LOW (zoom) with Delay

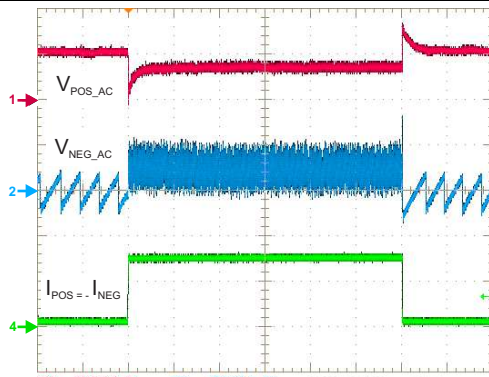

Figure 92. Load Transient — $V_{IN} = 2.9 \text{ V}$
SYNC = HIGH — $\Delta I_{OUT} = 140 \text{ mA}$

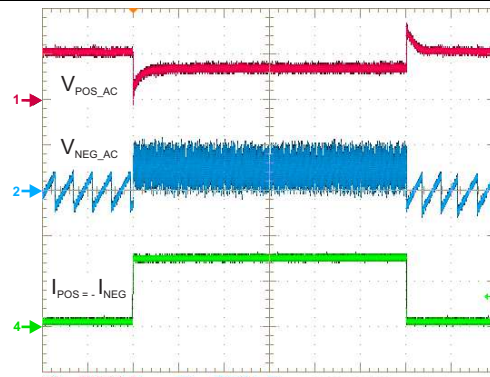
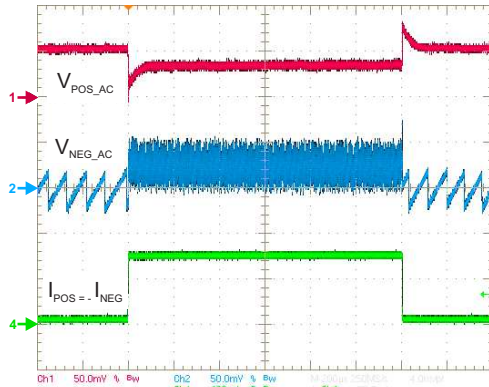
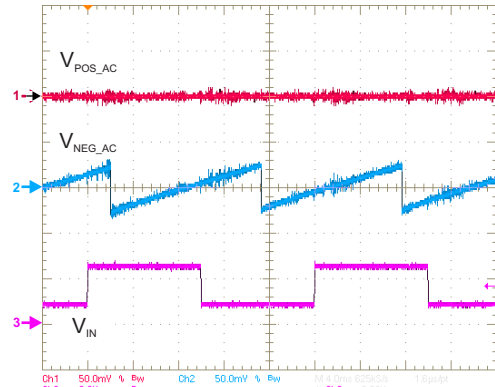

Figure 93. Load Transient — $V_{IN} = 3.7 \text{ V}$
SYNC = HIGH — $\Delta I_{OUT} = 140 \text{ mA}$



**Figure 94. Load Transient — $V_{IN} = 4.5\text{ V}$
SYNC = HIGH — $\Delta I_{OUT} = 140\text{ mA}$**



**Figure 95. Line Transient — $I_{OUT} = 10\text{ mA}$
SYNC = HIGH — $\Delta V_{IN} = 1.7\text{ V}$**

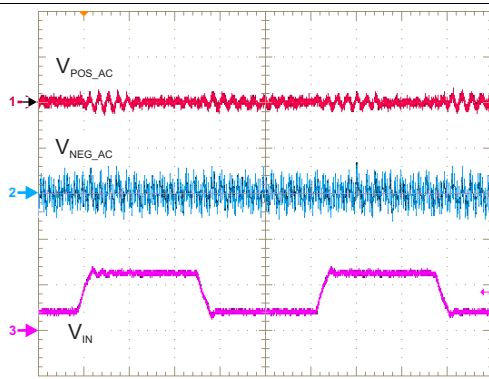

**Figure 96. Line Transient — $I_{OUT} = 100\text{ mA}$
SYNC = HIGH — $\Delta V_{IN} = 1.7\text{ V}$**

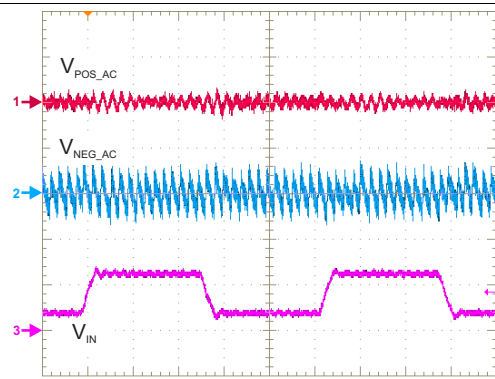

**Figure 97. Line Transient — $I_{OUT} = 150\text{ mA}$
SYNC = HIGH — $\Delta V_{IN} = 1.7\text{ V}$**

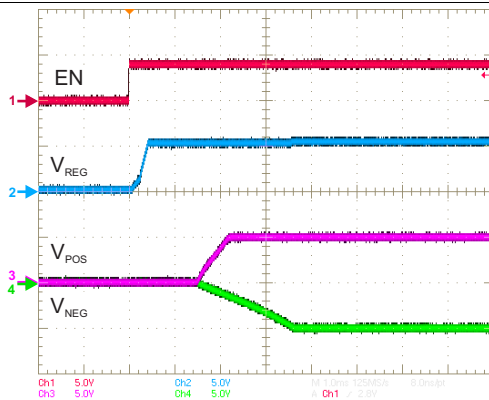

**Figure 98. Power-Up Sequencing — Simultaneous
SYNC = HIGH**

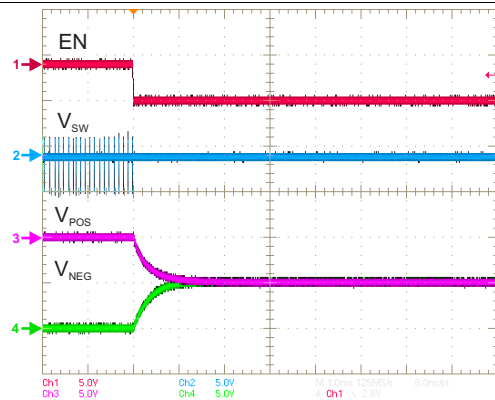

**Figure 99. Power-Down Sequencing — Simultaneous
SYNC = HIGH**

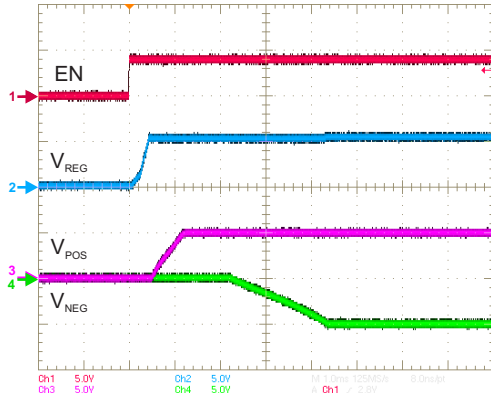

Figure 100. Power-Up Sequencing — Sequential VPOS → VNEG — SYNC = HIGH

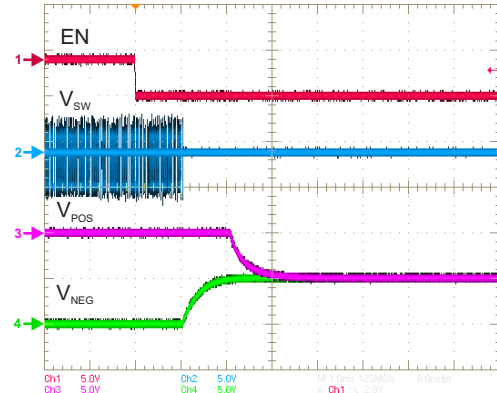

Figure 101. Power-Down Sequencing — Sequential VNEG → VPOS — SYNC = HIGH

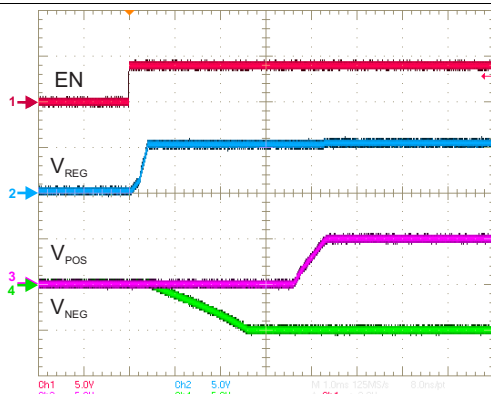

Figure 102. Power-Up Sequencing — Sequential VNEG → VPOS — SYNC = HIGH

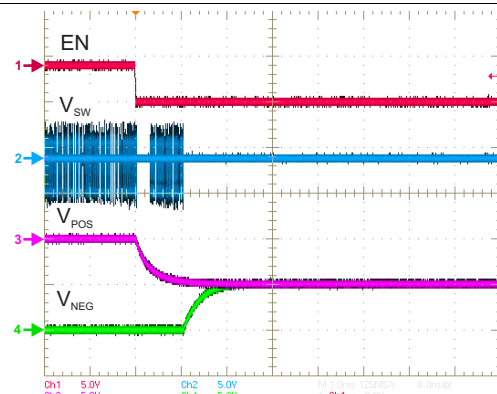

Figure 103. Power-Down Sequencing — Sequential VPOS → VNEG — SYNC = HIGH

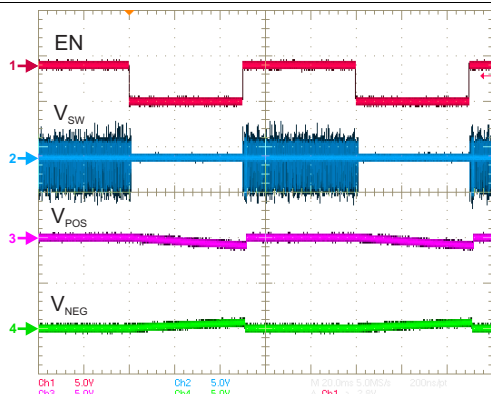

Figure 104. Power-Up/Down Without Active Discharge — SYNC = HIGH

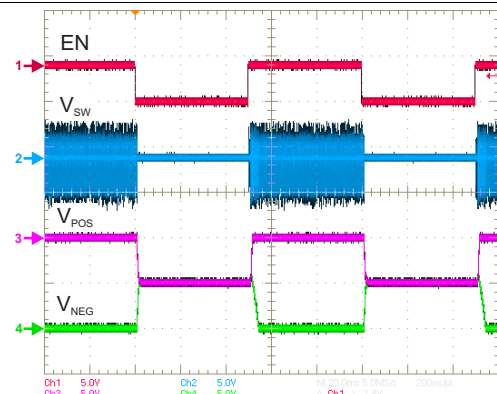

Figure 105. Power-Up/Down With Active Discharge — SYNC = HIGH

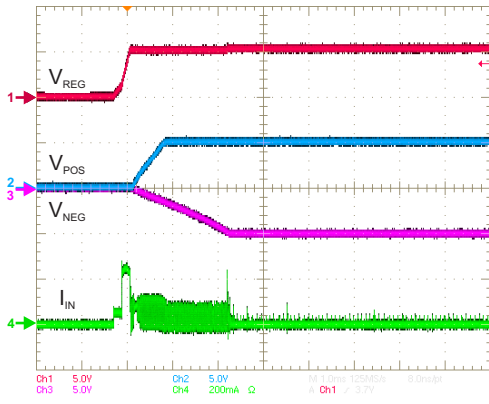

Figure 106. Inrush Current — Simultaneous — SYNC = HIGH

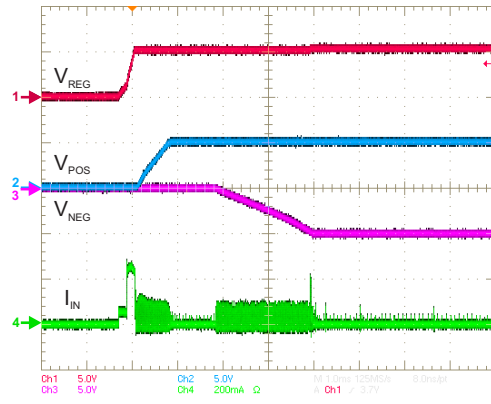

Figure 107. Inrush Current — Sequential SYNC = HIGH

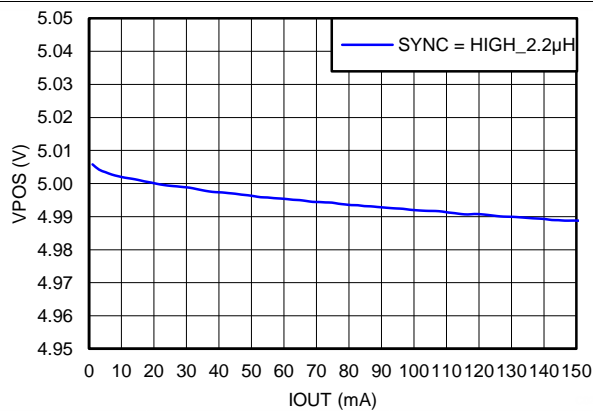

Figure 108. Load Regulation V_{POS} = 5.0 V — SYNC = HIGH

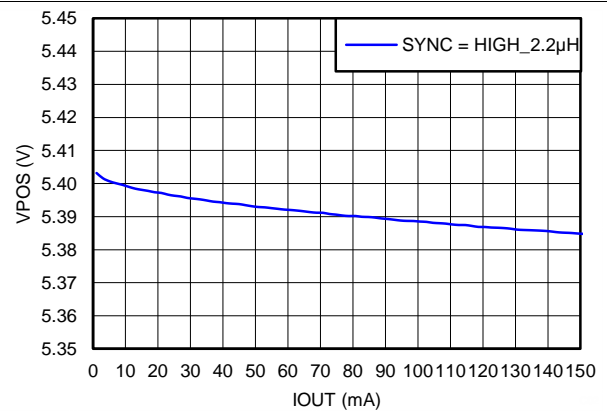

Figure 109. Load Regulation V_{POS} = 5.4 V — SYNC = HIGH

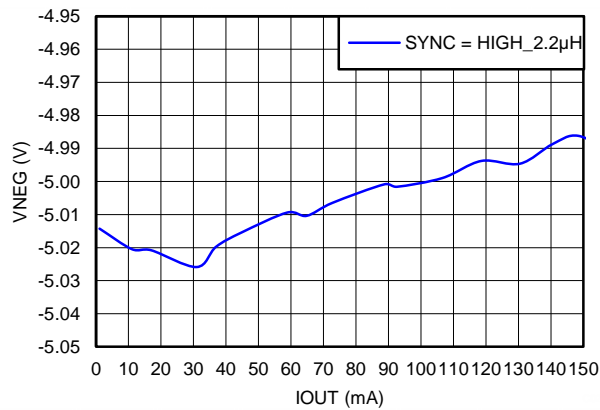

Figure 110. Load Regulation V_{NEG} = -5.0 V — SYNC = HIGH

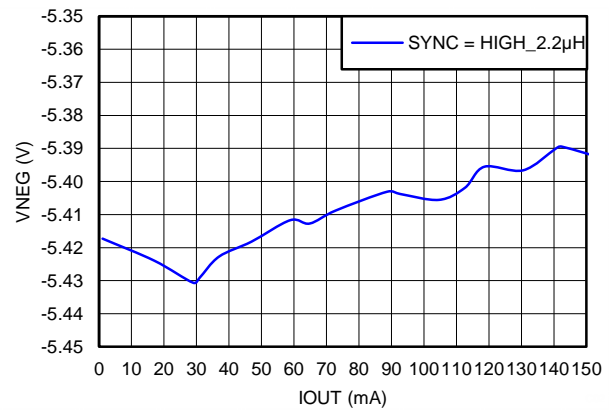

Figure 111. Load Regulation V_{NEG} = -5.4 V — SYNC = HIGH

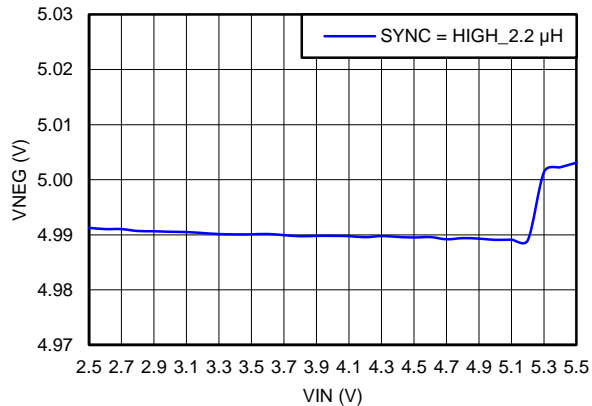

Figure 112. Line Regulation V_{POS} = 5.0 V — SYNC = HIGH

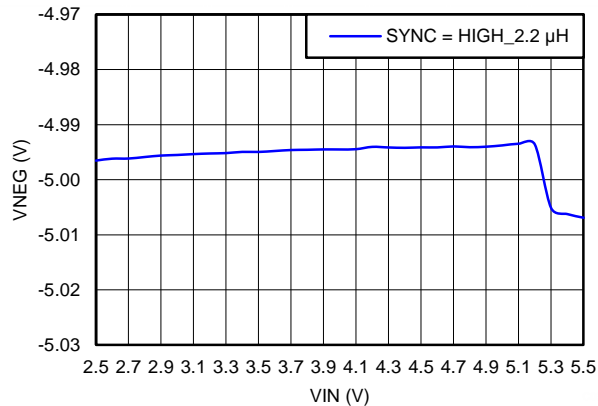

Figure 113. Line Regulation V_{POS} = 5.4 V — SYNC = HIGH

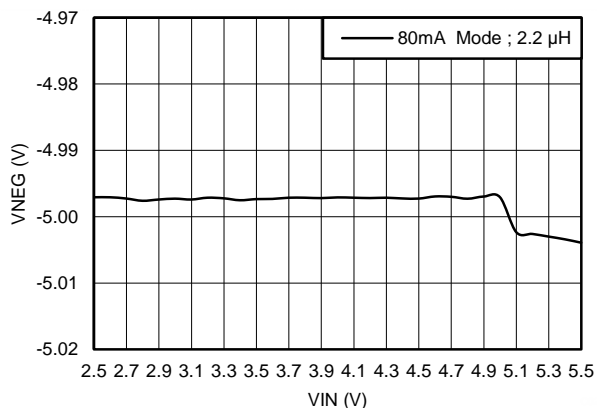

Figure 114. Line Regulation V_{NEG} = -5.0 V — SYNC = HIGH

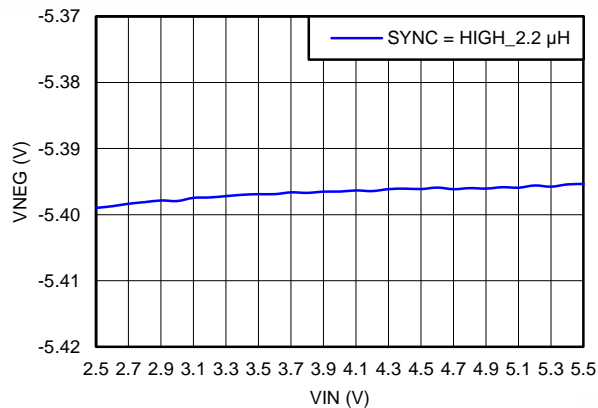

Figure 115. Line Regulation V_{NEG} = -5.4 V — SYNC = HIGH

10 Power Supply Recommendations

The devices are designed to operate from an input voltage supply range between 2.5 V and 5.5 V. This input supply must be well regulated. A ceramic input capacitor with a value of 4.7 μ F is a typical choice.

11 Layout

11.1 Layout Guidelines

PCB layout is an important task in the power supply design. Good PCB layout minimizes EMI and allows very good output voltage regulation. For the TPS65132 the following PCB layout guidelines are recommended.

- **Keep the power ground plane on the top layer (all capacitor grounds and PGND pins must be connected together with one uninterrupted ground plane).**
- **AGND and PGND must be connected together on the same ground plane.**
- **Place the flying capacitor as close as possible to the IC.**
- Always avoid vias when possible. They have high inductance and resistance. **If vias are necessary, always use more than one in parallel to decrease parasitics especially for power lines.**
- **Connect REG pins together.**
- For **high dv/dt** signals (switch pin traces): keep copper area to a minimum to prevent making unintentional parallel plate capacitors with other traces or to a ground plane. Best to route signal and return on same layer.
- For **high di/dt** signals: keep traces short, wide and closely spaced. This will reduce stray inductance and decrease the current loop area to help prevent EMI.
- Keep input capacitor close to the IC with low inductance traces.
- Keep trace from switching node pin to inductor short if possible: **it reduces EMI emissions and noise that may couple into other portions of the converter.**
- Isolate analog signal paths from power paths.

11.2 Layout Example

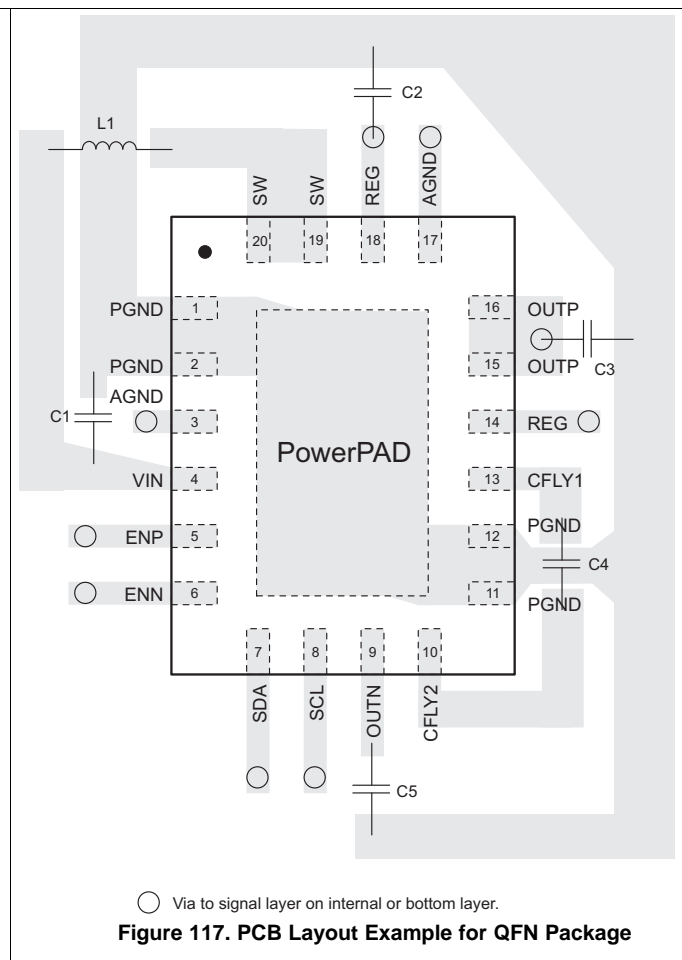
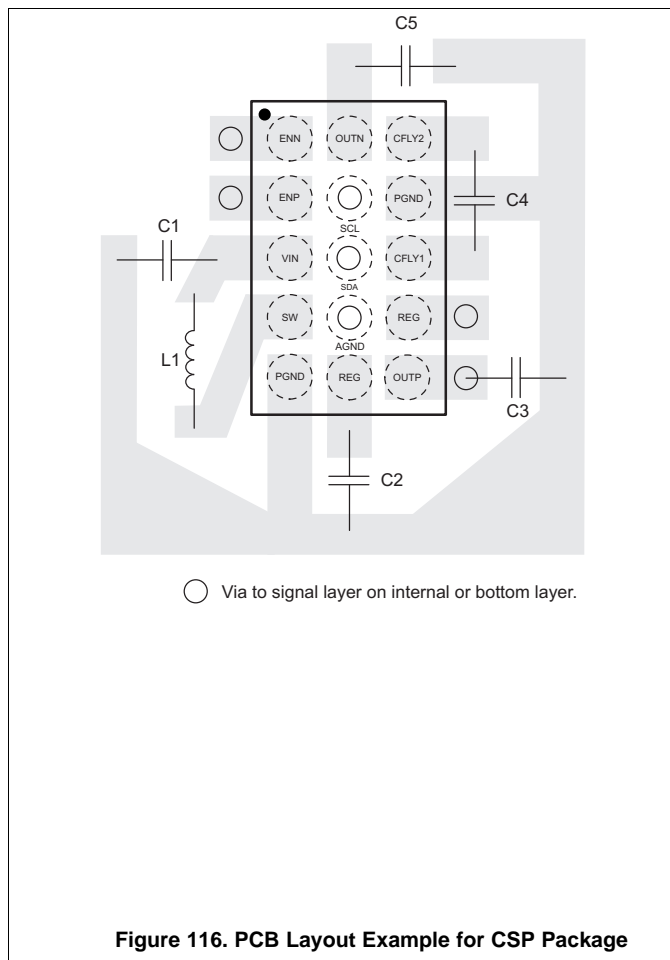

12 Device and Documentation Support

12.1 Device Support

12.1.1 Third-Party Products Disclaimer

TI'S PUBLICATION OF INFORMATION REGARDING THIRD-PARTY PRODUCTS OR SERVICES DOES NOT CONSTITUTE AN ENDORSEMENT REGARDING THE SUITABILITY OF SUCH PRODUCTS OR SERVICES OR A WARRANTY, REPRESENTATION OR ENDORSEMENT OF SUCH PRODUCTS OR SERVICES, EITHER ALONE OR IN COMBINATION WITH ANY TI PRODUCT OR SERVICE.

12.2 Receiving Notification of Documentation Updates

To receive notification of documentation updates, navigate to the device product folder on ti.com. In the upper right corner, click on *Alert me* to register and receive a weekly digest of any product information that has changed. For change details, review the revision history included in any revised document.

12.3 Community Resources

The following links connect to TI community resources. Linked contents are provided "AS IS" by the respective contributors. They do not constitute TI specifications and do not necessarily reflect TI's views; see TI's [Terms of Use](#).

TI E2E™ Online Community *TI's Engineer-to-Engineer (E2E) Community*. Created to foster collaboration among engineers. At e2e.ti.com, you can ask questions, share knowledge, explore ideas and help solve problems with fellow engineers.

Design Support *TI's Design Support* Quickly find helpful E2E forums along with design support tools and contact information for technical support.

12.4 Trademarks

E2E is a trademark of Texas Instruments.
All other trademarks are the property of their respective owners.

12.5 Electrostatic Discharge Caution



These devices have limited built-in ESD protection. The leads should be shorted together or the device placed in conductive foam during storage or handling to prevent electrostatic damage to the MOS gates.

12.6 Glossary

[SLYZ022](#) — *TI Glossary*.

This glossary lists and explains terms, acronyms, and definitions.

13 Mechanical, Packaging, and Orderable Information

The following pages include mechanical packaging and orderable information. This information is the most current data available for the designated devices. This data is subject to change without notice and revision of this document. For browser-based versions of this data sheet, refer to the left-hand navigation.

13.1 CSP Package Summary

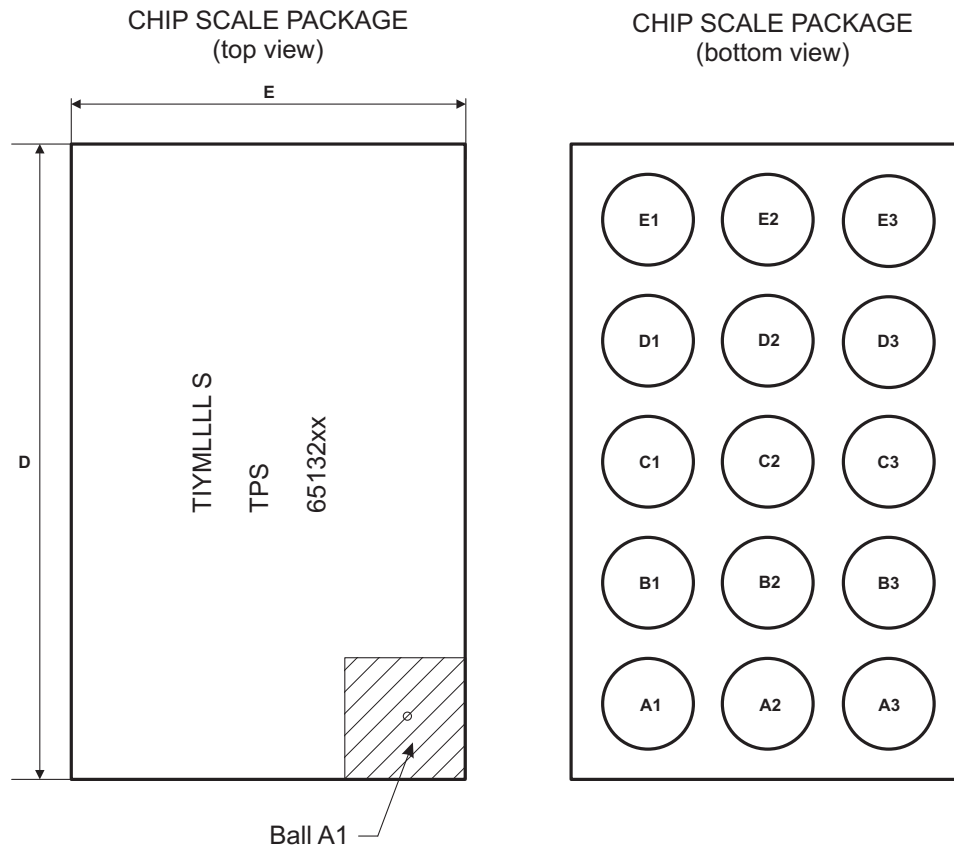
Code:

- TI -- TI letters
- YM -- Year-Month date code
- LLLL -- Lot trace code
- S -- Assembly site code
- xx -- Revision code (contains alpha-numeric characters - can be left blank), refer to the Ordering Information section for detailed information)

13.1.1 Chip Scale Package Dimensions

The TPS65132 device is available in a 15-bump chip scale package (YFF, NanoFree™). The package dimensions are given as:

- $D = 2108 \pm 30 \mu\text{m}$
- $E = 1514 \pm 30 \mu\text{m}$

CSP Package Summary (continued)

13.1.2 RVC Package Summary

QFN PACKAGE
(top view)

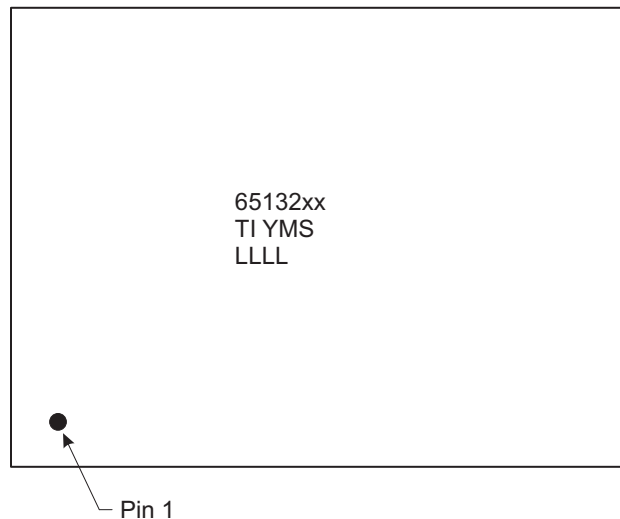

QFN PACKAGE
(bottom view)

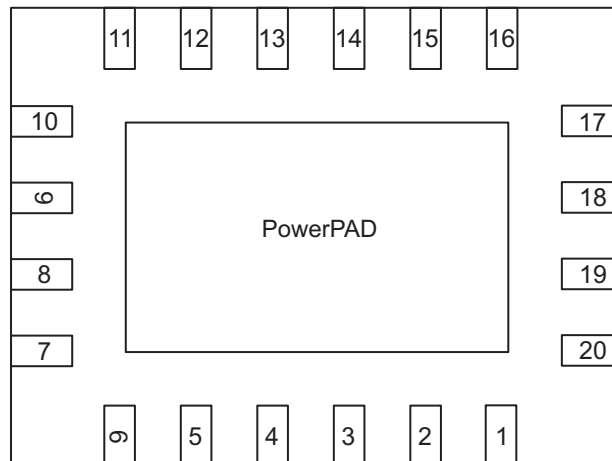

Code:

- TI -- TI letters
- YM -- Year-Month date code
- LLLL -- Lot trace code
- S -- Assembly site code
- xx -- Revision code (contains alpha-numeric characters - can be left blank), refer to the Ordering Information section for detailed information)

PACKAGING INFORMATION

Orderable Device	Status (1)	Package Type	Package Drawing	Pins	Package Qty	Eco Plan (2)	Lead/Ball Finish (6)	MSL Peak Temp (3)	Op Temp (°C)	Device Marking (4/5)	Samples
TPS65132A0YFFR	ACTIVE	DSBGA	YFF	15	3000	Green (RoHS & no Sb/Br)	SNAGCU	Level-1-260C-UNLIM	-40 to 85	TPS 65132A0	Samples
TPS65132AYFFR	ACTIVE	DSBGA	YFF	15	3000	Green (RoHS & no Sb/Br)	SNAGCU	Level-1-260C-UNLIM	-40 to 85	TPS 65132A	Samples
TPS65132B0YFFR	ACTIVE	DSBGA	YFF	15	3000	Green (RoHS & no Sb/Br)	SNAGCU	Level-1-260C-UNLIM	-40 to 85	TPS 65132B0	Samples
TPS65132B2YFFR	ACTIVE	DSBGA	YFF	15	3000	Green (RoHS & no Sb/Br)	SNAGCU	Level-1-260C-UNLIM	-40 to 85	TPS 65132B2	Samples
TPS65132B5YFFR	ACTIVE	DSBGA	YFF	15	3000	Green (RoHS & no Sb/Br)	SNAGCU	Level-1-260C-UNLIM	-40 to 85	TPS 65132B5	Samples
TPS65132BYFFR	ACTIVE	DSBGA	YFF	15	3000	Green (RoHS & no Sb/Br)	SNAGCU	Level-1-260C-UNLIM	-40 to 85	TPS 65132B	Samples
TPS65132L0YFFR	ACTIVE	DSBGA	YFF	15	3000	Green (RoHS & no Sb/Br)	SNAGCU	Level-1-260C-UNLIM	-40 to 85	TPS 65132L0	Samples
TPS65132L0YFFT	ACTIVE	DSBGA	YFF	15	250	Green (RoHS & no Sb/Br)	SNAGCU	Level-1-260C-UNLIM	-40 to 85	TPS 65132L0	Samples
TPS65132LYFFR	ACTIVE	DSBGA	YFF	15	3000	Green (RoHS & no Sb/Br)	SNAGCU	Level-1-260C-UNLIM	-40 to 85	TPS 65132L	Samples
TPS65132SYFFR	ACTIVE	DSBGA	YFF	15	3000	Green (RoHS & no Sb/Br)	SNAGCU	Level-1-260C-UNLIM	-40 to 85	TPS 65132S	Samples
TPS65132T6YFFR	ACTIVE	DSBGA	YFF	15	3000	Green (RoHS & no Sb/Br)	SNAGCU	Level-1-260C-UNLIM	-40 to 85	TPS 65132T6	Samples
TPS65132T6YFFT	ACTIVE	DSBGA	YFF	15	250	Green (RoHS & no Sb/Br)	SNAGCU	Level-1-260C-UNLIM	-40 to 85	TPS 65132T6	Samples
TPS65132WRVCR	ACTIVE	WQFN	RVC	20	3000	Green (RoHS & no Sb/Br)	CU NIPDAU	Level-2-260C-1 YEAR	-40 to 85	65132YA	Samples
TPS65132WRVCT	ACTIVE	WQFN	RVC	20	250	Green (RoHS & no Sb/Br)	CU NIPDAU	Level-2-260C-1 YEAR	-40 to 85	65132YA	Samples

(1) The marketing status values are defined as follows:

ACTIVE: Product device recommended for new designs.

LIFEBUY: TI has announced that the device will be discontinued, and a lifetime-buy period is in effect.

NRND: Not recommended for new designs. Device is in production to support existing customers, but TI does not recommend using this part in a new design.

PREVIEW: Device has been announced but is not in production. Samples may or may not be available.

OBSOLETE: TI has discontinued the production of the device.

(2) Eco Plan - The planned eco-friendly classification: Pb-Free (RoHS), Pb-Free (RoHS Exempt), or Green (RoHS & no Sb/Br) - please check <http://www.ti.com/productcontent> for the latest availability information and additional product content details.

TBD: The Pb-Free/Green conversion plan has not been defined.

Pb-Free (RoHS): TI's terms "Lead-Free" or "Pb-Free" mean semiconductor products that are compatible with the current RoHS requirements for all 6 substances, including the requirement that lead not exceed 0.1% by weight in homogeneous materials. Where designed to be soldered at high temperatures, TI Pb-Free products are suitable for use in specified lead-free processes.

Pb-Free (RoHS Exempt): This component has a RoHS exemption for either 1) lead-based flip-chip solder bumps used between the die and package, or 2) lead-based die adhesive used between the die and leadframe. The component is otherwise considered Pb-Free (RoHS compatible) as defined above.

Green (RoHS & no Sb/Br): TI defines "Green" to mean Pb-Free (RoHS compatible), and free of Bromine (Br) and Antimony (Sb) based flame retardants (Br or Sb do not exceed 0.1% by weight in homogeneous material)

(3) MSL, Peak Temp. - The Moisture Sensitivity Level rating according to the JEDEC industry standard classifications, and peak solder temperature.

(4) There may be additional marking, which relates to the logo, the lot trace code information, or the environmental category on the device.

(5) Multiple Device Markings will be inside parentheses. Only one Device Marking contained in parentheses and separated by a "~" will appear on a device. If a line is indented then it is a continuation of the previous line and the two combined represent the entire Device Marking for that device.

(6) Lead/Ball Finish - Orderable Devices may have multiple material finish options. Finish options are separated by a vertical ruled line. Lead/Ball Finish values may wrap to two lines if the finish value exceeds the maximum column width.

Important Information and Disclaimer: The information provided on this page represents TI's knowledge and belief as of the date that it is provided. TI bases its knowledge and belief on information provided by third parties, and makes no representation or warranty as to the accuracy of such information. Efforts are underway to better integrate information from third parties. TI has taken and continues to take reasonable steps to provide representative and accurate information but may not have conducted destructive testing or chemical analysis on incoming materials and chemicals. TI and TI suppliers consider certain information to be proprietary, and thus CAS numbers and other limited information may not be available for release.

In no event shall TI's liability arising out of such information exceed the total purchase price of the TI part(s) at issue in this document sold by TI to Customer on an annual basis.

TAPE AND REEL INFORMATION

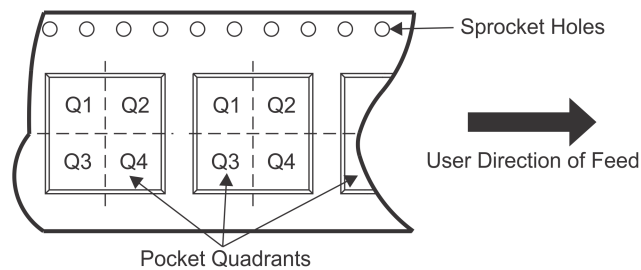
QUADRANT ASSIGNMENTS FOR PIN 1 ORIENTATION IN TAPE

*All dimensions are nominal

Device	Package Type	Package Drawing	Pins	SPQ	Reel Diameter (mm)	Reel Width W1 (mm)	A0 (mm)	B0 (mm)	K0 (mm)	P1 (mm)	W (mm)	Pin1 Quadrant
TPS65132A0YFFR	DSBGA	YFF	15	3000	180.0	8.4	1.61	2.21	0.7	4.0	8.0	Q1
TPS65132A0YFFR	DSBGA	YFF	15	3000	178.0	9.2	1.61	2.21	0.7	4.0	8.0	Q1
TPS65132B0YFFR	DSBGA	YFF	15	3000	180.0	8.4	1.61	2.21	0.7	4.0	8.0	Q1
TPS65132B0YFFR	DSBGA	YFF	15	3000	178.0	9.2	1.61	2.21	0.7	4.0	8.0	Q1
TPS65132B2YFFR	DSBGA	YFF	15	3000	180.0	8.4	1.61	2.21	0.7	4.0	8.0	Q1
TPS65132B5YFFR	DSBGA	YFF	15	3000	180.0	8.4	1.61	2.21	0.7	4.0	8.0	Q1
TPS65132BYFFR	DSBGA	YFF	15	3000	180.0	8.4	1.61	2.21	0.7	4.0	8.0	Q1
TPS65132L0YFFR	DSBGA	YFF	15	3000	180.0	8.4	1.61	2.21	0.7	4.0	8.0	Q1
TPS65132L0YFFT	DSBGA	YFF	15	250	180.0	8.4	1.61	2.21	0.7	4.0	8.0	Q1
TPS65132LYFFR	DSBGA	YFF	15	3000	180.0	8.4	1.61	2.21	0.7	4.0	8.0	Q1
TPS65132SYFFR	DSBGA	YFF	15	3000	180.0	8.4	1.61	2.21	0.7	4.0	8.0	Q1
TPS65132T6YFFR	DSBGA	YFF	15	3000	180.0	8.4	1.61	2.21	0.7	4.0	8.0	Q1
TPS65132T6YFFT	DSBGA	YFF	15	250	180.0	8.4	1.61	2.21	0.7	4.0	8.0	Q1
TPS65132WRVCR	WQFN	RVC	20	3000	330.0	12.4	3.3	4.3	1.1	8.0	12.0	Q1
TPS65132WRVCT	WQFN	RVC	20	250	180.0	12.4	3.3	4.3	1.1	8.0	12.0	Q1

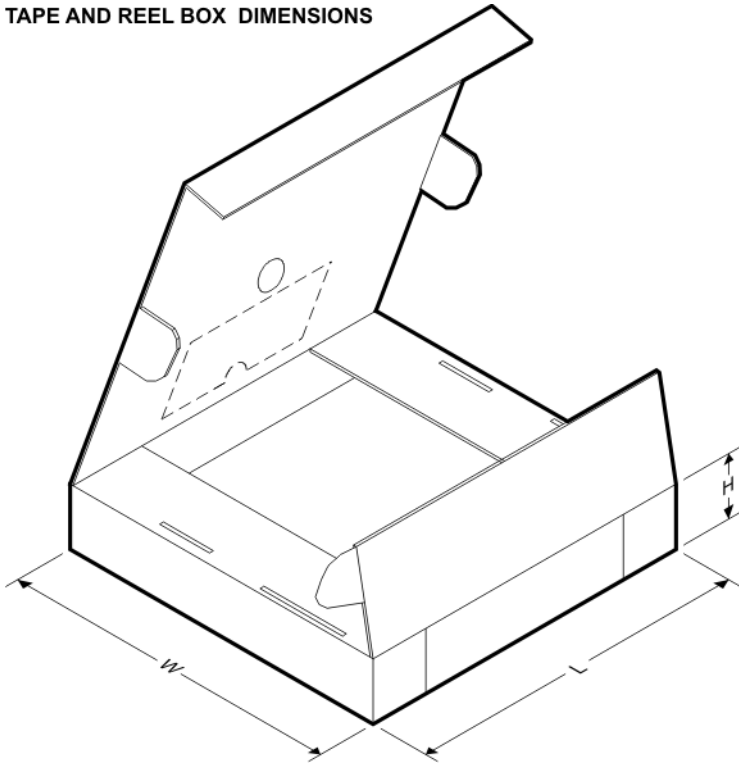
TAPE AND REEL BOX DIMENSIONS

*All dimensions are nominal

Device	Package Type	Package Drawing	Pins	SPQ	Length (mm)	Width (mm)	Height (mm)
TPS65132A0YFFR	DSBGA	YFF	15	3000	182.0	182.0	20.0
TPS65132A0YFFR	DSBGA	YFF	15	3000	220.0	220.0	35.0
TPS65132B0YFFR	DSBGA	YFF	15	3000	182.0	182.0	20.0
TPS65132B0YFFR	DSBGA	YFF	15	3000	220.0	220.0	35.0
TPS65132B2YFFR	DSBGA	YFF	15	3000	182.0	182.0	20.0
TPS65132B5YFFR	DSBGA	YFF	15	3000	182.0	182.0	20.0
TPS65132BYFFR	DSBGA	YFF	15	3000	182.0	182.0	20.0
TPS65132L0YFFR	DSBGA	YFF	15	3000	182.0	182.0	20.0
TPS65132L0YFFT	DSBGA	YFF	15	250	182.0	182.0	20.0
TPS65132LYFFR	DSBGA	YFF	15	3000	182.0	182.0	20.0
TPS65132SYFFR	DSBGA	YFF	15	3000	182.0	182.0	20.0
TPS65132T6YFFR	DSBGA	YFF	15	3000	182.0	182.0	20.0
TPS65132T6YFFT	DSBGA	YFF	15	250	182.0	182.0	20.0
TPS65132WRVCR	WQFN	RVC	20	3000	552.0	367.0	36.0
TPS65132WRVCT	WQFN	RVC	20	250	552.0	185.0	36.0

GENERIC PACKAGE VIEW

RVC 20

WQFN - 0.8 mm max height

PLASTIC QUAD FLATPACK - NO LEAD

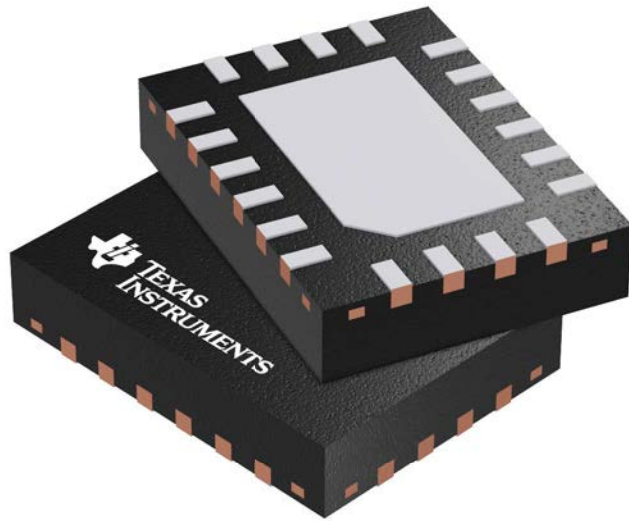

Images above are just a representation of the package family, actual package may vary.
Refer to the product data sheet for package details.

4209819/B

EXAMPLE BOARD LAYOUT

RVC0020A

WQFN - 0.8 mm max height

PLASTIC QUAD FLATPACK - NO LEAD

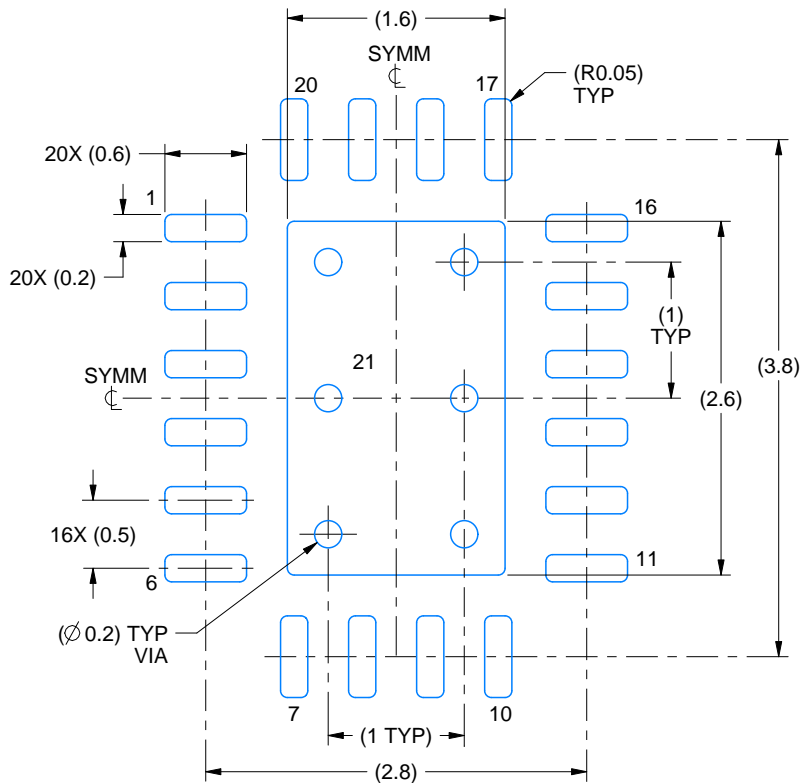

LAND PATTERN EXAMPLE
EXPOSED METAL SHOWN
SCALE:18X

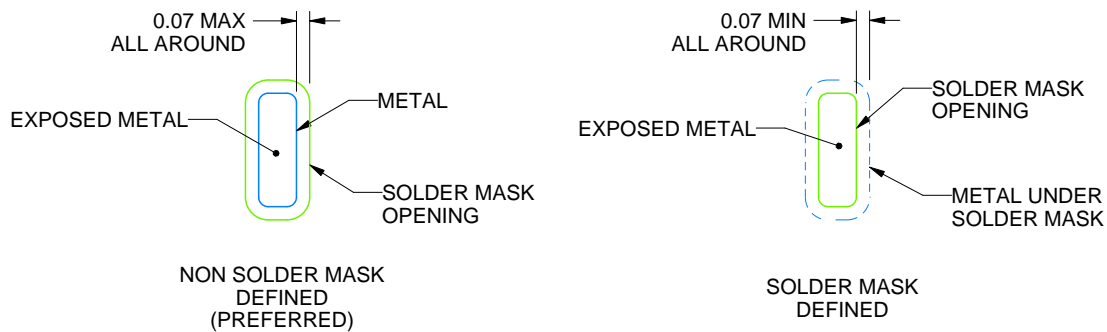

SOLDER MASK DETAILS

4219150/B 03/2017

NOTES: (continued)

- This package is designed to be soldered to a thermal pad on the board. For more information, see Texas Instruments literature number SLUA271 (www.ti.com/lit/slua271).
- Vias are optional depending on application, refer to device data sheet. If any vias are implemented, refer to their locations shown on this view. It is recommended that vias under paste be filled, plugged or tented.

EXAMPLE STENCIL DESIGN

RVC0020A

WQFN - 0.8 mm max height

PLASTIC QUAD FLATPACK - NO LEAD

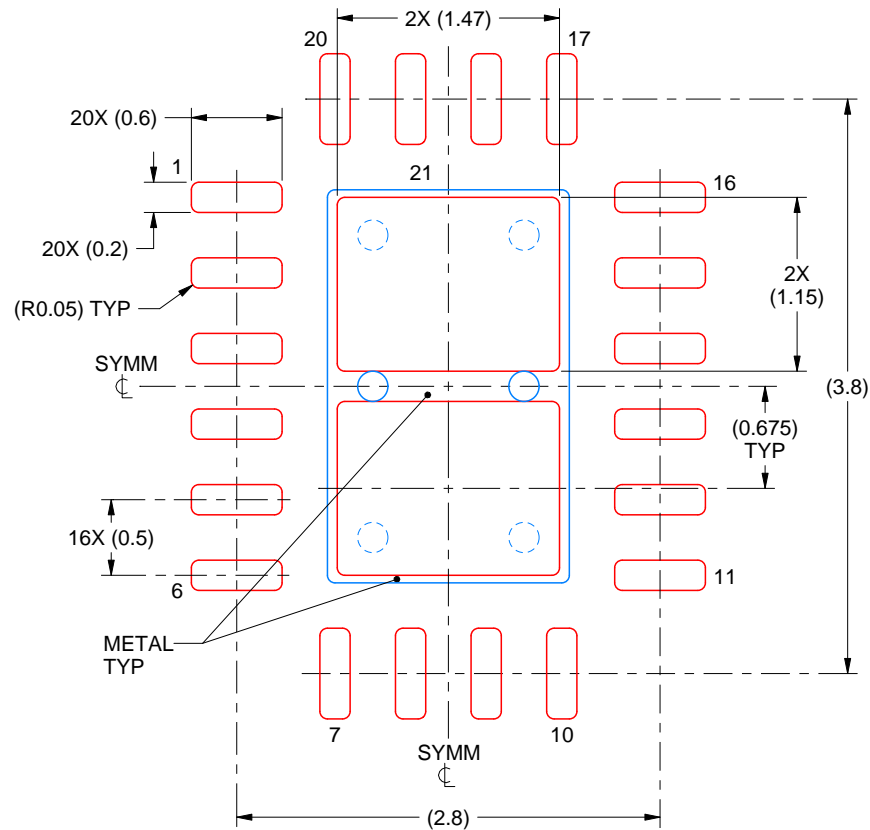

SOLDER PASTE EXAMPLE
BASED ON 0.1 mm THICK STENCIL

EXPOSED PAD X
81% PRINTED SOLDER COVERAGE BY AREA UNDER PACKAGE
SCALE:20X

4219150/B 03/2017

NOTES: (continued)

6. Laser cutting apertures with trapezoidal walls and rounded corners may offer better paste release. IPC-7525 may have alternate design recommendations.

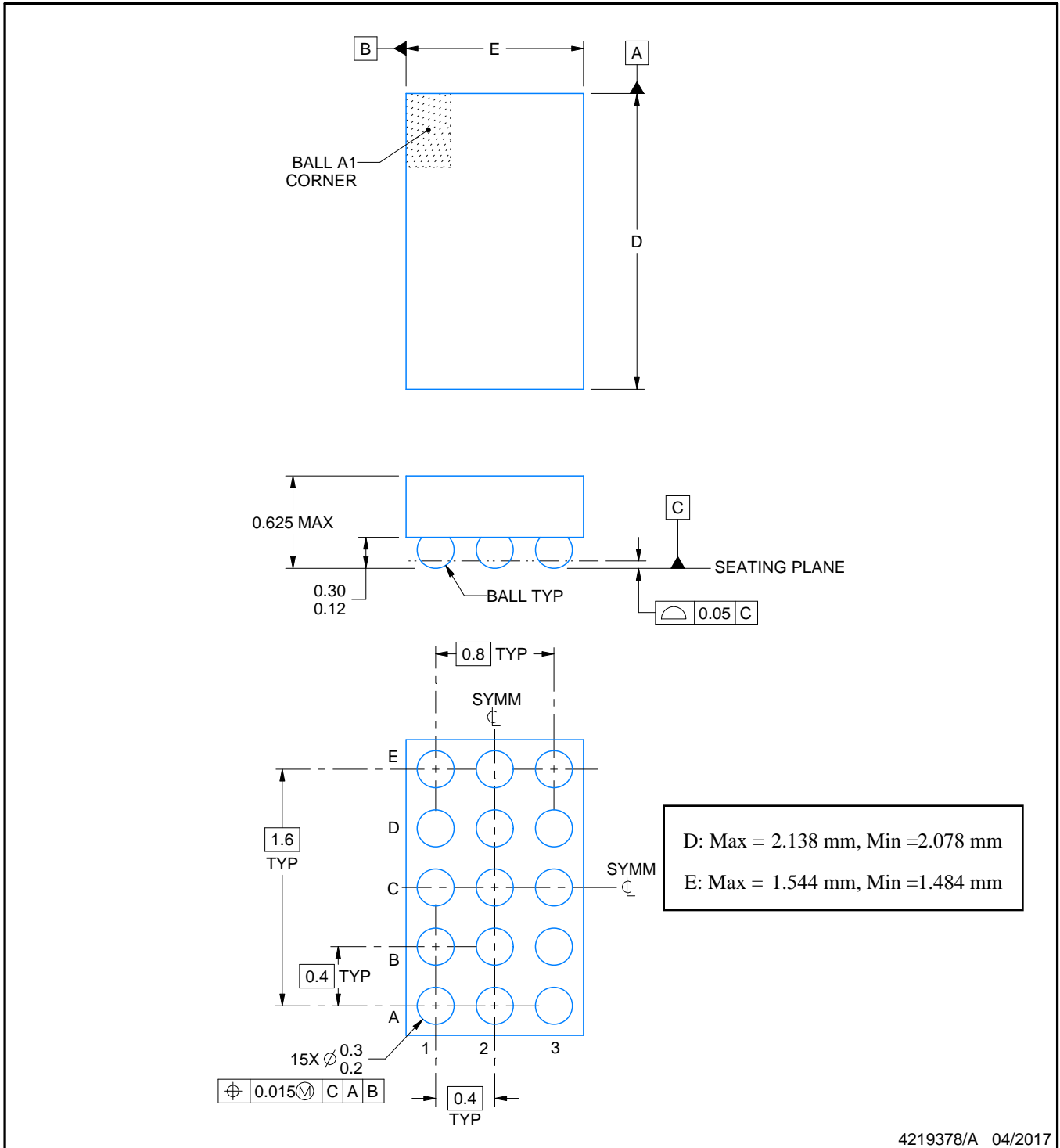
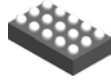

NOTES:

1. All linear dimensions are in millimeters. Any dimensions in parenthesis are for reference only. Dimensioning and tolerancing per ASME Y14.5M.
2. This drawing is subject to change without notice.

EXAMPLE BOARD LAYOUT

YFF0015

DSBGA - 0.625 mm max height

DIE SIZE BALL GRID ARRAY

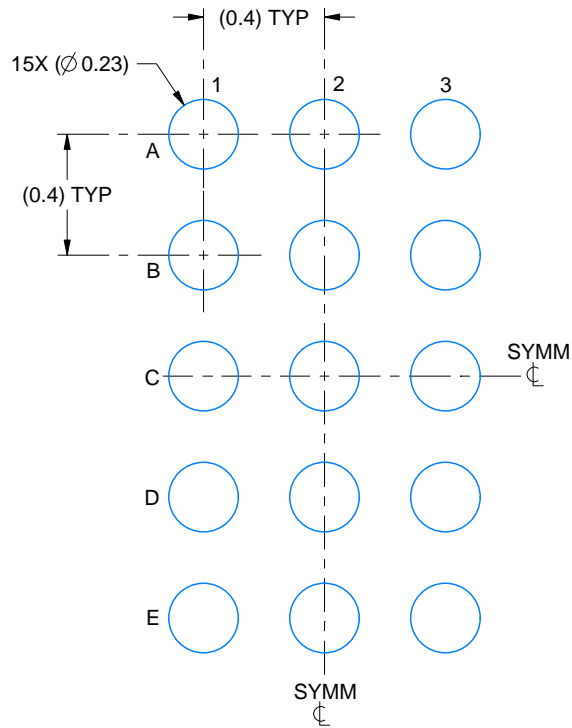

LAND PATTERN EXAMPLE
EXPOSED METAL SHOWN
SCALE:40X

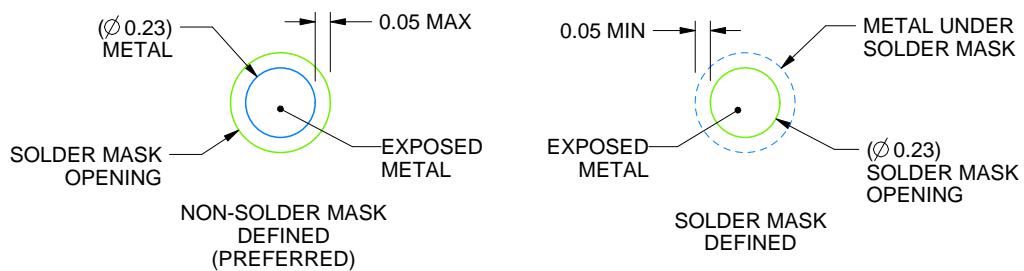

SOLDER MASK DETAILS
NOT TO SCALE

4219378/A 04/2017

NOTES: (continued)

- Final dimensions may vary due to manufacturing tolerance considerations and also routing constraints. For more information, see Texas Instruments literature number SNVA009 (www.ti.com/lit/snva009).

EXAMPLE STENCIL DESIGN

YFF0015

DSBGA - 0.625 mm max height

DIE SIZE BALL GRID ARRAY

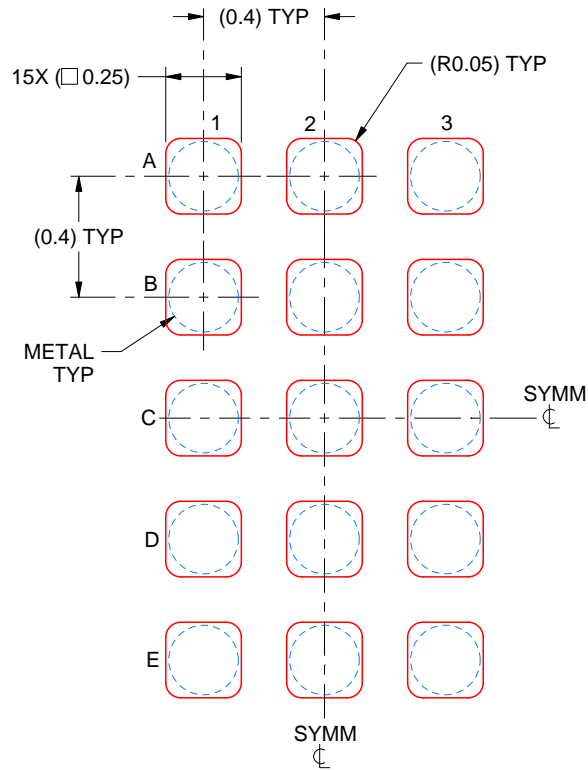

SOLDER PASTE EXAMPLE
BASED ON 0.1 mm THICK STENCIL
SCALE:40X

4219378/A 04/2017

NOTES: (continued)

4. Laser cutting apertures with trapezoidal walls and rounded corners may offer better paste release.

IMPORTANT NOTICE AND DISCLAIMER

TI PROVIDES TECHNICAL AND RELIABILITY DATA (INCLUDING DATASHEETS), DESIGN RESOURCES (INCLUDING REFERENCE DESIGNS), APPLICATION OR OTHER DESIGN ADVICE, WEB TOOLS, SAFETY INFORMATION, AND OTHER RESOURCES "AS IS" AND WITH ALL FAULTS, AND DISCLAIMS ALL WARRANTIES, EXPRESS AND IMPLIED, INCLUDING WITHOUT LIMITATION ANY IMPLIED WARRANTIES OF MERCHANTABILITY, FITNESS FOR A PARTICULAR PURPOSE OR NON-INFRINGEMENT OF THIRD PARTY INTELLECTUAL PROPERTY RIGHTS.

These resources are intended for skilled developers designing with TI products. You are solely responsible for (1) selecting the appropriate TI products for your application, (2) designing, validating and testing your application, and (3) ensuring your application meets applicable standards, and any other safety, security, or other requirements. These resources are subject to change without notice. TI grants you permission to use these resources only for development of an application that uses the TI products described in the resource. Other reproduction and display of these resources is prohibited. No license is granted to any other TI intellectual property right or to any third party intellectual property right. TI disclaims responsibility for, and you will fully indemnify TI and its representatives against, any claims, damages, costs, losses, and liabilities arising out of your use of these resources.

TI's products are provided subject to TI's Terms of Sale (www.ti.com/legal/termsofsale.html) or other applicable terms available either on ti.com or provided in conjunction with such TI products. TI's provision of these resources does not expand or otherwise alter TI's applicable warranties or warranty disclaimers for TI products.

Mailing Address: Texas Instruments, Post Office Box 655303, Dallas, Texas 75265
Copyright © 2019, Texas Instruments Incorporated

Looking for pricing, stock, or lifecycle information?

Click below to explore more details on WIN SOURCE:

 [View TPS65132AYFFR](#) on WIN SOURCE

 [Texas Instruments](#) Information

Optimize Your Supply Chain with WIN SOURCE Solutions

-  Global Sourcing Solution
-  Obsolete Management
-  Cost Control Management
-  Shortage Management
-  Alternative Solution
-  Excess Inventory Management