



**THE DATASHEET OF
TPS63000EVM-148**



TPS6300x High-Efficient Single Inductor Buck-Boost Converter With 1.8-A Switches

1 Features

- Input Voltage Range: 1.8 V to 5.5 V
- Fixed and Adjustable Output Voltage Options from 1.2 V to 5.5 V
- Up to 96% Efficiency
- 1200-mA Output Current at 3.3 V in Step-Down Mode ($V_{IN} = 3.6 \text{ V to } 5.5 \text{ V}$)
- Up to 800-mA Output Current at 3.3 V in Boost Mode ($V_{IN} > 2.4 \text{ V}$)
- Automatic Transition Between Step-Down and Boost Mode
- Device Quiescent Current less than 50 μA
- Power-Save Mode for Improved Efficiency at Low Output Power
- Forced Fixed Frequency Operation and Synchronization Possible
- Load Disconnect During Shutdown
- Overtemperature Protection
- Available in a Small 3-mm \times 3-mm 10-Pin VSON Package (QFN)

2 Applications

- All Two-Cell and Three-Cell Alkaline, NiCd or NiMH or Single-Cell Li Battery Powered Products
- Portable Audio Players
- Smart Phones
- Personal Medical Products
- White LEDs

3 Description

The TPS6300x devices provide a power supply solution for products powered by either a two-cell or three-cell alkaline, NiCd or NiMH battery, or a one-cell Li-ion or Li-polymer battery. Output currents can go as high as 1200 mA while using a single-cell Li-ion or Li-polymer battery, and discharge it down to 2.5 V or lower. The buck-boost converter is based on a fixed frequency, pulse width modulation (PWM) controller using synchronous rectification to obtain maximum efficiency. At low load currents, the converter enters power-save mode to maintain high efficiency over a wide load current range. The power-save mode can be disabled, forcing the converter to operate at a fixed switching frequency. The maximum average current in the switches is limited to a typical value of 1800 mA. The output voltage is programmable using an external resistor divider, or is fixed internally on the chip. The converter can be disabled to minimize battery drain. During shutdown, the load is disconnected from the battery.

The TPS6300x devices operate over a free air temperature range of -40°C to 85°C . The devices are packaged in a 10-pin VSON package (QFN) measuring 3 mm \times 3 mm (DRC).

Device Information⁽¹⁾

PART NUMBER	PACKAGE	BODY SIZE (NOM)
TPS63000	VSON (10)	3.00 mm \times 3.00 mm
TPS63001		
TPS63002		

(1) For all available packages, see the orderable addendum at the end of the datasheet.

Typical Application Schematic

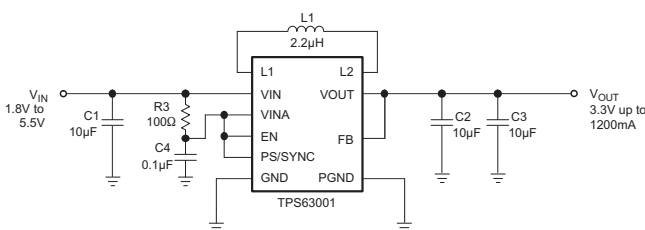

Efficiency vs Output Current

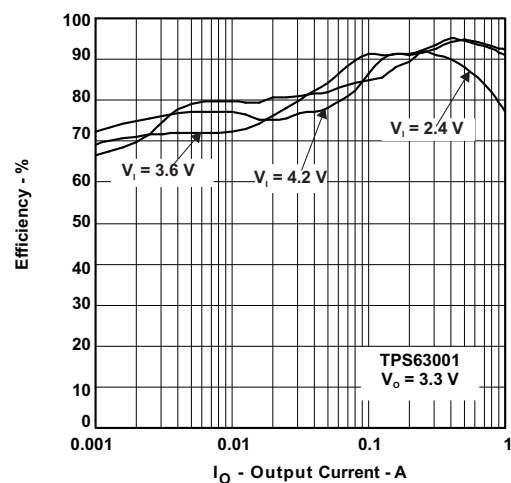

Table of Contents

1 Features 1 2 Applications 1 3 Description 1 4 Revision History 2 5 Pin Configuration and Functions 3 6 Specifications 4 6.1 Absolute Maximum Ratings 4 6.2 ESD Ratings..... 4 6.3 Recommended Operating Conditions 4 6.4 Thermal Information 4 6.5 Electrical Characteristics..... 5 6.6 Typical Characteristics 6 7 Detailed Description 7 7.1 Overview 7 7.2 Functional Block Diagram 7 7.3 Feature Description..... 8 7.4 Device Functional Modes..... 9	8 Application and Implementation 10 8.1 Application Information..... 10 8.2 Typical Application 10 9 Power Supply Recommendations 15 10 Layout 16 10.1 Layout Guidelines 16 10.2 Layout Example 16 10.3 Thermal Considerations 16 11 Device and Documentation Support 17 11.1 Device Support..... 17 11.2 Related Links 17 11.3 Community Resources..... 17 11.4 Trademarks 17 11.5 Electrostatic Discharge Caution..... 17 11.6 Glossary 17 12 Mechanical, Packaging, and Orderable Information 17
--	---

4 Revision History

NOTE: Page numbers for previous revisions may differ from page numbers in the current version.

Changes from Revision B (August 2008) to Revision C	Page
<ul style="list-style-type: none"> • Added <i>ESD Ratings</i> table, <i>Feature Description</i> section, <i>Device Functional Modes</i>, <i>Application and Implementation</i> section, <i>Power Supply Recommendations</i> section, <i>Layout</i> section, <i>Device and Documentation Support</i> section, and <i>Mechanical, Packaging, and Orderable Information</i> section 	1

5 Pin Configuration and Functions

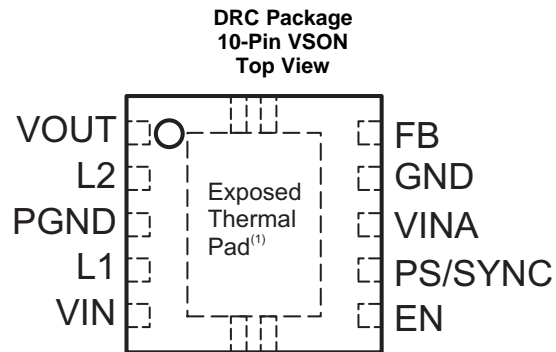

(1) The exposed thermal pad is connected to PGND.

Pin Functions

PIN		I/O	DESCRIPTION
NAME	NO.		
EN	6	IN	Enable input (1 enabled, 0 disabled)
FB	10	IN	Voltage feedback of adjustable versions, must be connected to VOUT on fixed output voltage versions
GND	9	—	Control / logic ground
L1	4	IN	Connection for inductor
L2	2	IN	Connection for inductor
PGND	3	—	Power ground
PS/SYNC	7	IN	Enable / disable power-save mode (1 disabled, 0 enabled, clock signal for synchronization)
VIN	5	IN	Supply voltage for power stage
VINA	8	IN	Supply voltage for control stage
VOUT	1	OUT	Buck-boost converter output
Exposed Thermal Pad	—	—	The exposed thermal pad is connected to PGND.

6 Specifications

6.1 Absolute Maximum Ratings

over operating free-air temperature range (unless otherwise noted)⁽¹⁾

	MIN	MAX	UNIT
Input voltage on VIN, VINA, L1, L2, VOUT, PS/SYNC, EN, FB	-0.3	7	V
Operating virtual junction temperature, T _J	-40	150	°C
Storage temperature, T _{stg}	-65	150	°C

- (1) Stresses beyond those listed under *absolute maximum ratings* may cause permanent damage to the device. These are stress ratings only, and functional operation of the device at these or any other conditions beyond those indicated under *recommended operating conditions* is not implied. Exposure to absolute-maximum-rated conditions for extended periods may affect device reliability.

6.2 ESD Ratings

		VALUE	UNIT
V _(ESD)	Electrostatic discharge	Human body model (HBM), per ANSI/ESDA/JEDEC JS-001, all pins ⁽¹⁾	2000
		Charged device model (CDM), per JEDEC specification JESD22-C101, all pins ⁽²⁾	1000

- (1) JEDEC document JEP155 states that 500-V HBM allows safe manufacturing with a standard ESD control process.
 (2) JEDEC document JEP157 states that 250-V CDM allows safe manufacturing with a standard ESD control process.

6.3 Recommended Operating Conditions

	MIN	MAX	UNIT
Supply voltage at VIN, VINA	1.8	5.5	V
Operating free air temperature, T _A	-40	85	°C
Operating virtual junction temperature, T _J	-40	125	°C

6.4 Thermal Information

THERMAL METRIC ⁽¹⁾		TPS6300x	UNIT
		DRC (VSON)	
		10 PINS	
R _{θJA}	Junction-to-ambient thermal resistance	46.8	°C/W
R _{θJC(top)}	Junction-to-case (top) thermal resistance	62.5	°C/W
R _{θJB}	Junction-to-board thermal resistance	21.4	°C/W
ψ _{JT}	Junction-to-top characterization parameter	1.4	°C/W
ψ _{JB}	Junction-to-board characterization parameter	21.5	°C/W
R _{θJC(bot)}	Junction-to-case (bottom) thermal resistance	4.1	°C/W

- (1) For more information about traditional and new thermal metrics, see the *Semiconductor and IC Package Thermal Metrics* application report, [SPRA953](#).

6.5 Electrical Characteristics

over recommended free-air temperature range and over recommended input voltage range (typical at an ambient temperature range of 25°C) (unless otherwise noted)

PARAMETER		TEST CONDITIONS	MIN	TYP	MAX	UNIT
DC-DC STAGE						
V_{IN}	Input voltage range		1.8		5.5	V
V_{IN}	Input voltage range for start-up		1.9		5.5	V
V_{OUT}	TPS63000 output voltage range		1.2		5.5	V
V_{FB}	TPS63000 feedback voltage	PS/SYNC = V_{IN}	495	500	505	mV
f	Oscillator frequency		1250		1500	kHz
	Frequency range for synchronization		1250		1800	kHz
I_{SW}	Switch current limit	$V_{IN} = V_{INA} = 3.6$ V, $T_A = 25^\circ\text{C}$	1600	1800	2000	mA
	High-side switch ON-resistance	$V_{IN} = V_{INA} = 3.6$ V		100		m Ω
	Low-side switch ON-resistance	$V_{IN} = V_{INA} = 3.6$ V		100		m Ω
	Line regulation				0.5%	
	Load regulation				0.5%	
I_q	Quiescent current	V_{IN}	$I_{OUT} = 0$ mA, $V_{EN} = V_{IN} = V_{INA} = 3.6$ V, $V_{OUT} = 3.3$ V	1	1.5	μA
		V_{INA}		40	50	μA
		V_{OUT} (adjustable output voltage)		4	6	μA
	FB input impedance (fixed output voltage)			1		M Ω
I_S	Shutdown current	$V_{EN} = 0$ V, $V_{IN} = V_{INA} = 3.6$ V		0.1	1	μA
CONTROL STAGE						
V_{UVLO}	Undervoltage lockout threshold	V_{INA} voltage decreasing	1.5	1.7	1.8	V
V_{IL}	EN, PS/SYNC input low voltage				0.4	V
V_{IH}	EN, PS/SYNC input high voltage		1.2			V
	EN, PS/SYNC input current	Clamped on GND or V_{INA}		0.01	0.1	μA
	Overtemperature protection			140		$^\circ\text{C}$
	Overtemperature hysteresis			20		$^\circ\text{C}$

6.6 Typical Characteristics

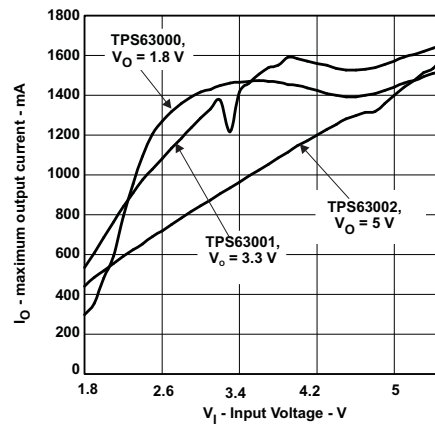

Figure 1. Maximum Output Current vs Input Voltage

7.3 Feature Description

7.3.1 Device Enable

The device is put into operation when EN is set high. It is put into a shutdown mode when EN is set to GND. In shutdown mode, the regulator stops switching, all internal control circuitry is switched off, and the load is disconnected from the input. This also means that the output voltage can drop below the input voltage during shutdown. During start-up of the converter, the duty cycle and the peak current are limited in order to avoid high peak currents flowing from the input.

7.3.2 Undervoltage Lockout

An undervoltage lockout function prevents device start-up if the supply voltage at VINA is lower than approximately its threshold (see [Electrical Characteristics](#)). When in operation, the device automatically enters the shutdown mode if the voltage at VINA drops below the undervoltage lockout threshold. The device automatically restarts if the input voltage recovers to the minimum operating input voltage.

7.3.3 Overtemperature Protection

The device has a built-in temperature sensor which monitors the internal IC temperature. If the temperature exceeds the programmed threshold (see [Electrical Characteristics](#)) the device stops operating. As soon as the IC temperature has decreased below the programmed threshold, it starts operating again. There is a built-in hysteresis to avoid unstable operation at IC temperatures at the overtemperature threshold.

7.4 Device Functional Modes

7.4.1 Soft-Start and Short Circuit Protection

After being enabled, the device starts operating. The average current limit ramps up from an initial 400 mA following the output voltage increasing. At an output voltage of about 1.2 V, the current limit is at its nominal value. If the output voltage does not increase, the current limit will not increase. There is no timer implemented. Thus the output voltage overshoot at start-up, as well as the inrush current, is kept at a minimum. The device ramps up the output voltage in a controlled manner even if a very large capacitor is connected at the output. When the output voltage does not increase above 1.2 V, the device assumes a short circuit at the output and keeps the current limit low to protect itself and the application. At a short at the output during operation the current limit also will be decreased accordingly. At 0 V at the output, for example, the output current will not exceed about 400 mA.

7.4.2 Buck-Boost Operation

To regulate the output voltage properly at all possible input voltage conditions, the device automatically switches from step-down operation to boost operation and back as required by the configuration. It always uses one active switch, one rectifying switch, one switch permanently on, and one switch permanently off. Therefore, it operates as a step-down converter (buck) when the input voltage is higher than the output voltage, and as a boost converter when the input voltage is lower than the output voltage. There is no mode of operation in which all 4 switches are permanently switching. Controlling the switches this way allows the converter to maintain high efficiency at the most important point of operation; when input voltage is close to the output voltage. The RMS current through the switches and the inductor is kept at a minimum, to minimize switching and conduction losses. Switching losses are also kept low by using only one active and one passive switch. For the remaining 2 switches, one is kept permanently on and the other is kept permanently off, thus causing no switching losses.

7.4.3 Power-Save Mode and Synchronization

The PS/SYNC pin can be used to select different operation modes. To enable power-save mode, PS/SYNC must be set low. Power-save mode is used to improve efficiency at light load. If power-save mode is enabled, the converter stops operating if the average inductor current gets lower than about 300 mA and the output voltage is at or above its nominal value. If the output voltage decreases below its nominal value, the device ramps up the output voltage again by starting operation using a programmed average inductor current higher than required by the current load condition. Operation can last for one or several pulses. The converter again stops operating once the conditions for stopping operation are met again.

The power-save mode can be disabled by programming high at the PS/SYNC. Connecting a clock signal at PS/SYNC forces the device to synchronize to the connected clock frequency. Synchronization is done by a phase-locked loop (PLL), so synchronizing to lower and higher frequencies compared to the internal clock works without any issues. The PLL can also tolerate missing clock pulses without the converter malfunctioning. The PS/SYNC input supports standard logic thresholds.

8 Application and Implementation

NOTE

Information in the following applications sections is not part of the TI component specification, and TI does not warrant its accuracy or completeness. TI's customers are responsible for determining suitability of components for their purposes. Customers should validate and test their design implementation to confirm system functionality.

8.1 Application Information

The TPS6300x DC–DC converters are intended for systems powered by one-cell Li-ion or Li-polymer battery with a typical voltage between 2.3 V and 4.5 V. They can also be used in systems powered by a double or triple cell alkaline, NiCd, or NiMH battery with a typical terminal voltage between 1.8 V and 5.5 V. Additionally, any other voltage source with a typical output voltage between 1.8 V and 5.5 V can power systems where the TPS6300x is used.

8.2 Typical Application

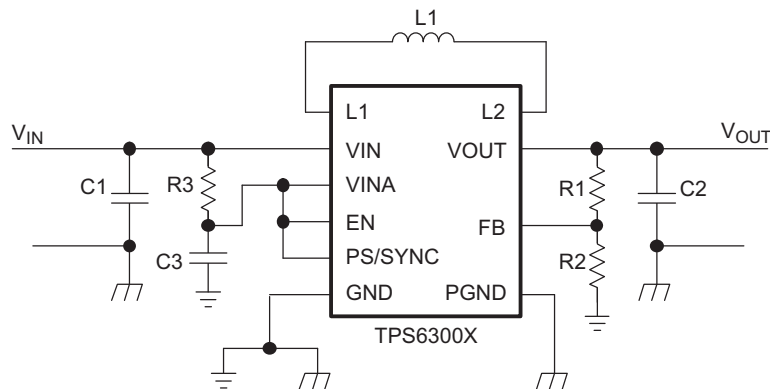

Figure 2. Typical Application Circuit for Adjustable Output Voltage Option

8.2.1 Design Requirements

The TPS63000 series of buck-boost converters have internal loop compensation. Therefore, the external LC filter has to be selected according to the internal compensation.

The design guideline provides a component selection to operate the device within the [Recommended Operating Conditions](#).

For the fixed output voltage option the feedback pin needs to be connected to VOUT.

[Table 1](#) shows the list of components for the application curves.

Table 1. List of Components

REFERENCE	DESCRIPTION	MANUFACTURER
	TPS63000 / TPS63001 / TPS63002	Texas Instruments
L1	VLF4012-2R2	TDK
C1	10 μ F 6.3 V, 0603, X7R ceramic	
C2	2 \times 10 μ F 6.3 V, 0603, X7R ceramic	
C3	0.1 μ F, X7R ceramic	
R3	100 Ω	
R1, R2	Depending on the output voltage at TPS63000, not used at TPS63001 / TPS63002	

8.2.2 Detailed Design Procedure

8.2.2.1 Programming the Output Voltage

Within the TPS6300x family, there are fixed and adjustable output voltage versions available. To properly configure the fixed output voltage devices, the FB pin is used to sense the output voltage. This means that it must be connected directly to VOUT. At the adjustable output voltage versions, an external resistor divider is used to adjust the output voltage. The resistor divider must be connected between VOUT, FB and GND. When the output voltage is regulated properly, the typical value of the voltage at the FB pin is 500 mV. The maximum recommended value for the output voltage is 5.5 V. The current through the resistive divider should be about 100 times greater than the current into the FB pin. The typical current into the FB pin is 0.01 μ A, and the voltage across the resistor between FB and GND, R_2 , is typically 500 mV. Based on those two values, the recommended value for R_2 should be lower than 500 k Ω , in order to set the divider current at 1 μ A or higher. TI recommends to keep the value for this resistor in the range of 200 k Ω . From that, the value of the resistor connected between VOUT and FB, R_1 , depending on the needed output voltage (V_{OUT}), can be calculated using [Equation 1](#).

$$R_1 = R_2 \times \left(\frac{V_{OUT}}{V_{FB}} - 1 \right) \quad (1)$$

If as an example, an output voltage of 3.3 V is needed, a 1-M Ω resistor should be chosen for R_1 . To improve control performance using a feedforward capacitor in parallel to R_1 is recommended. The value for the feedforward capacitor can be calculated using [Equation 2](#).

$$C_{ff} = \frac{2.2 \mu s}{R_1} \quad (2)$$

8.2.2.2 Inductor Selection

The inductor selection is affected by several parameter like inductor ripple current, output voltage ripple, transition point into power-save mode, and efficiency. See [Table 2](#) for typical inductors.

Table 2. List of Recommended Inductors

VENDOR	INDUCTOR SERIES
Coilcraft	LPS3015
	LPS4012
Murata	LQH3NP
Tajo Yuden	NR3015
TDK	VLF3215
	VLF4012

For high efficiencies, the inductor should have a low DC resistance to minimize conduction losses. Especially at high-switching frequencies, the core material has a high impact on efficiency. When using small chip inductors, the efficiency is reduced mainly due to higher inductor core losses. This needs to be considered when selecting the appropriate inductor. The inductor value determines the inductor ripple current. The larger the inductor value, the smaller the inductor ripple current and the lower the conduction losses of the converter. Conversely, larger inductor values cause a slower load transient response. To avoid saturation of the inductor, the peak current for the inductor in steady-state operation is calculated using [Equation 4](#). Only the equation which defines the switch current in boost mode is shown, because this provides the highest value of current and represents the critical current value for selecting the right inductor.

$$\text{Duty Cycle Boost} \quad D = \frac{V_{\text{OUT}} - V_{\text{IN}}}{V_{\text{OUT}}} \quad (3)$$

$$I_{\text{PEAK}} = \frac{I_{\text{out}}}{\eta \times (1 - D)} + \frac{V_{\text{in}} \times D}{2 \times f \times L}$$

where

- D = Duty Cycle in Boost mode
- f = Converter switching frequency (typical 2.5MHz)
- L = Inductor value
- η = Estimated converter efficiency (use the number from the efficiency curves or 0.90 as an assumption) (4)

NOTE

The calculation must be done for the minimum input voltage which is possible to have in boost mode.

Calculating the maximum inductor current using the actual operating conditions gives the minimum saturation current of the inductor needed. TI recommends to choose an inductor with a saturation current 20% higher than the value calculated using Equation 4. Possible inductors are listed in Table 2.

8.2.2.3 Capacitor Selection

8.2.2.3.1 Input Capacitor

At least a 4.7- μF input capacitor is recommended to improve transient behavior of the regulator and EMI behavior of the total power supply circuit. A ceramic capacitor placed as close as possible to the VIN and PGND pins of the IC is recommended.

8.2.2.3.2 Output Capacitor

For the output capacitor, use of a small ceramic capacitors placed as close as possible to the VOUT and PGND pins of the IC is recommended. The recommended nominal output capacitance value is 15 μF .

There is also no upper limit for the output capacitance value. Larger capacitors causes lower output voltage ripple as well as lower output voltage drop during load transients.

8.2.3 Application Curves

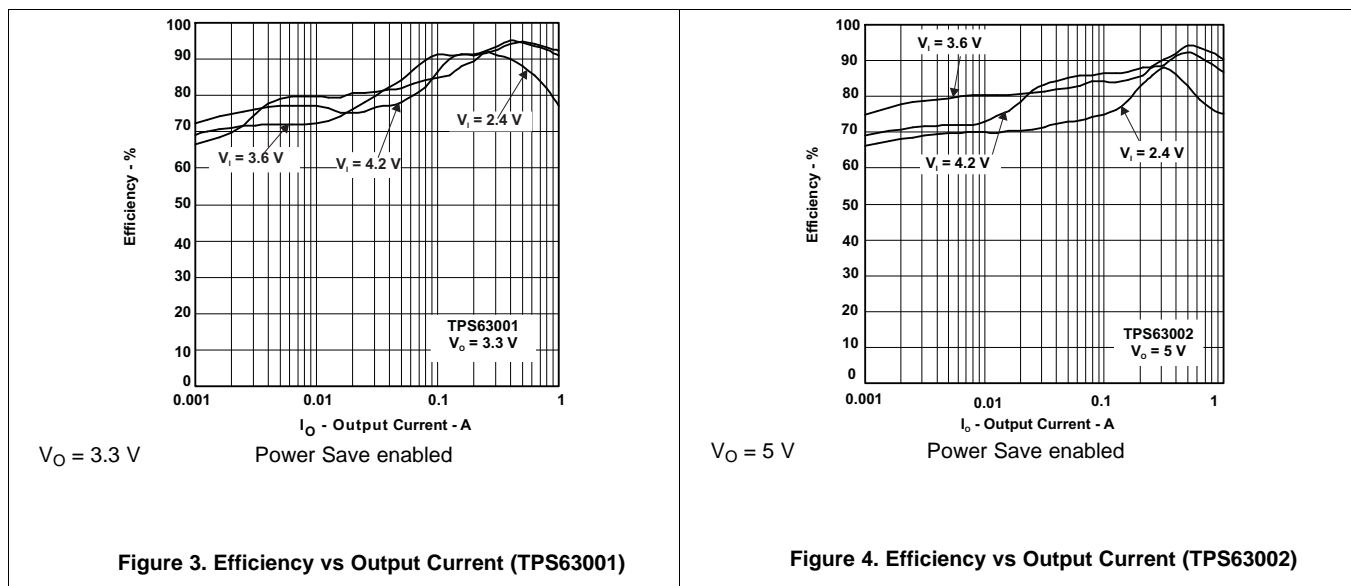

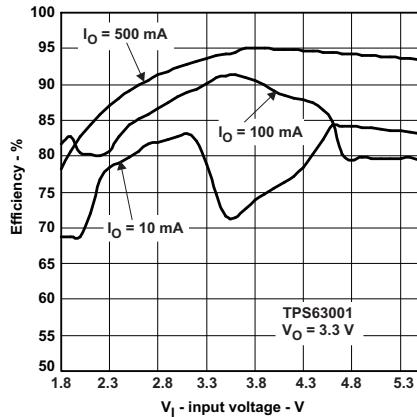

$V_O = 3.3\text{ V}$ Power Save enabled

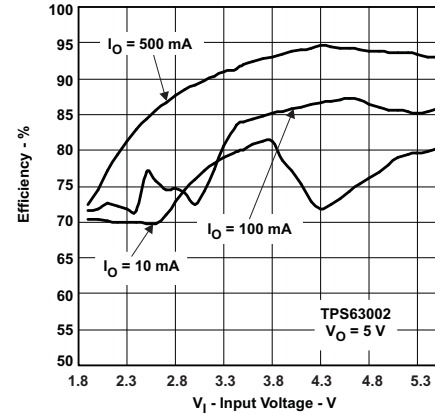

$V_O = 5\text{ V}$ Power Save enabled

Figure 5. Efficiency vs Input Voltage (TPS63001)

Figure 6. Efficiency vs Input Voltage (TPS63002)

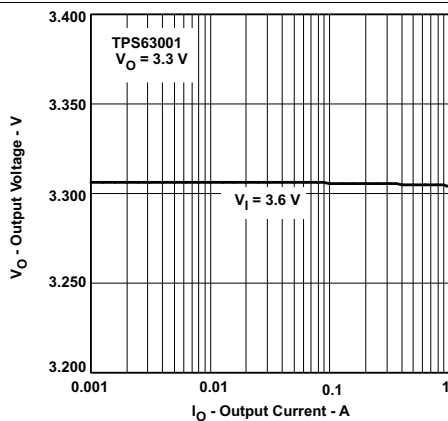

$V_O = 3.3\text{ V}$

Figure 7. Output Voltage vs Output Current (TPS63001)

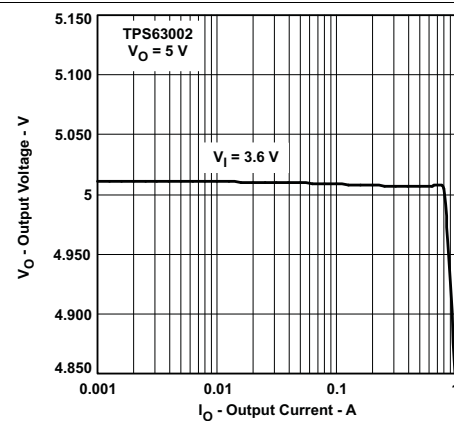

$V_O = 5\text{ V}$

Figure 8. Output Voltage vs Output Current (TPS63002)

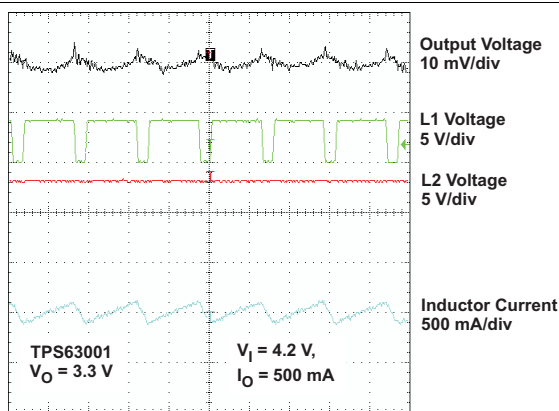

$V_O = 3.3\text{ V}$ $V_I = 4.2\text{ V}$ $I_O = 500\text{ mA}$

Figure 9. Output Voltage in Continuous Current Mode (TPS63001, $V_{IN} > V_{OUT}$)

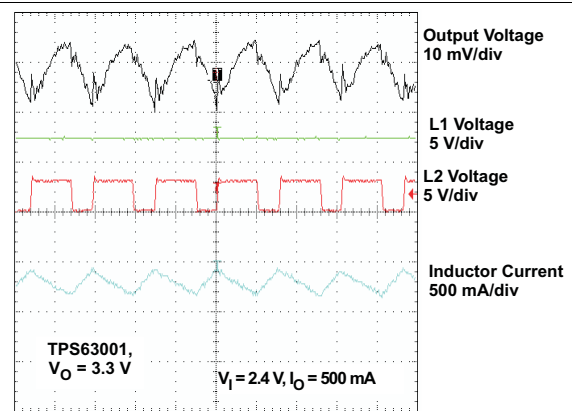

$V_O = 3.3\text{ V}$ $V_I = 2.4\text{ V}$ $I_O = 500\text{ mA}$

Figure 10. Output Voltage in Continuous Current Mode (TPS63001, $V_{IN} > V_{OUT}$)

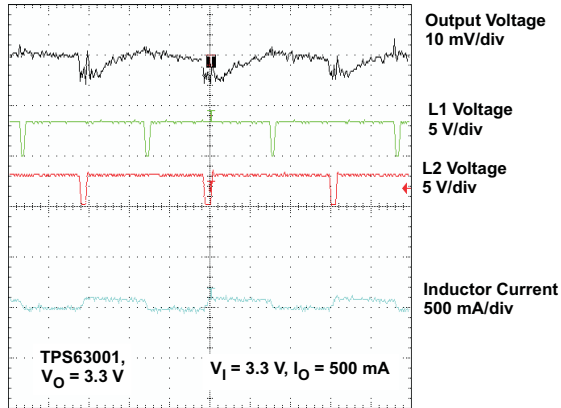

Timebase 500 ns/div
 $V_O = 3.3\text{ V}$ $V_I = 3.3\text{ V}$ $I_O = 500\text{ mA}$

Figure 11. Output Voltage in Continuous Current Mode (TPS63001, $V_{IN} = V_{OUT}$)

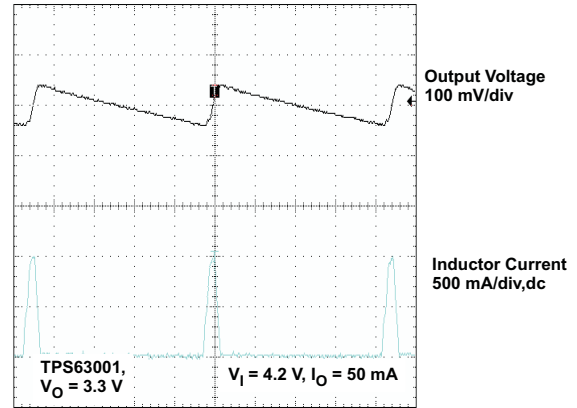

Timebase 5 $\mu\text{s}/\text{Div}$
 $V_O = 3.3\text{ V}$ $V_I = 4.2\text{ V}$ $I_O = 50\text{ mA}$

Figure 12. Output Voltage in Power-Save Mode (TPS63001, $V_{IN} > V_{OUT}$)

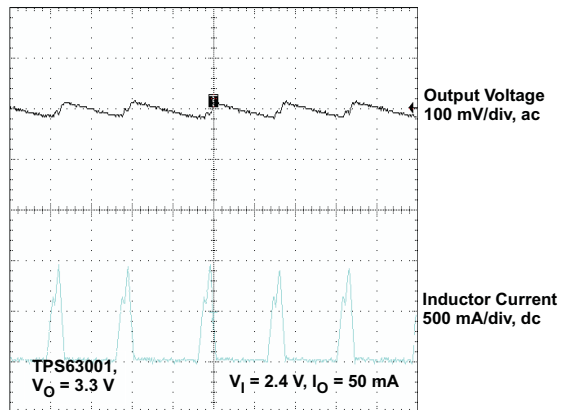

Timebase 5 $\mu\text{s}/\text{div}$
 $V_O = 3.3\text{ V}$ $V_I = 2.4\text{ V}$ $I_O = 50\text{ mA}$

Figure 13. Output Voltage in Power-Save Mode (TPS63001, $V_{IN} < V_{OUT}$)

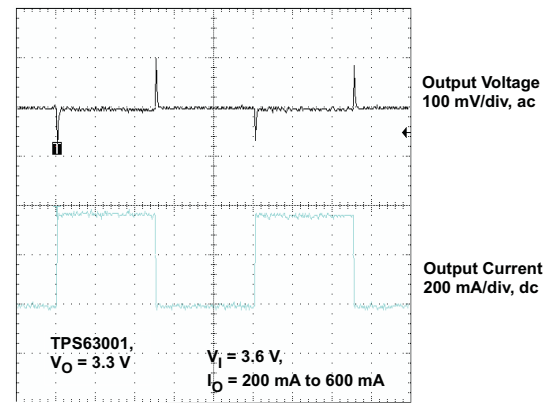

Timebase 2 ms/div
 $V_O = 3.3\text{ V}$ $V_I = 3.6\text{ V}$ $I_O = 200\text{ mA to } 600\text{ mA}$

Figure 14. Load Transient Response (TPS63001, $V_{IN} > V_{OUT}$)

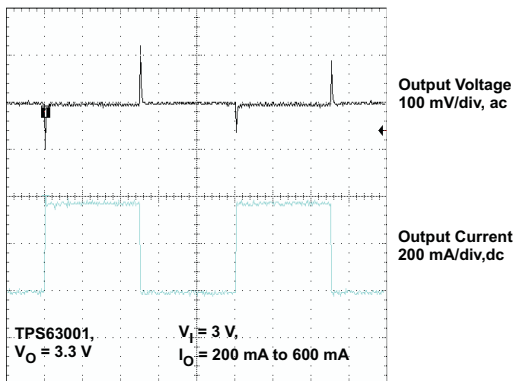

Timebase 2 ms/div
 $V_O = 3.3\text{ V}$ $V_I = 3\text{ V}$ $I_O = 200\text{ mA to } 600\text{ mA}$

Figure 15. Load Transient Response (TPS63001, $V_{IN} < V_{OUT}$)

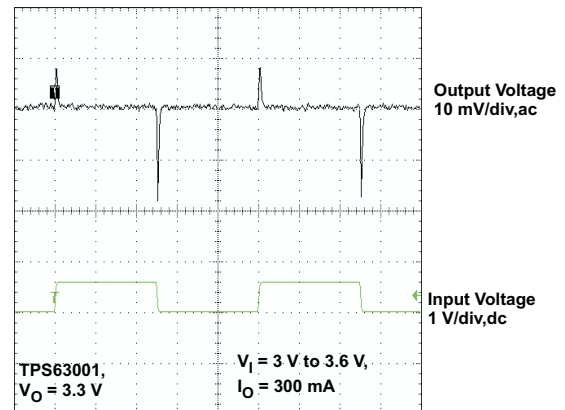

Timebase 2 ms/div
 $V_O = 3.3\text{ V}$ $V_I = 3\text{ V to } 3.6\text{ V}$ $I_O = 300\text{ mA}$

Figure 16. Line Transient Response (TPS63001, $I_{OUT} = 300\text{ mA}$)

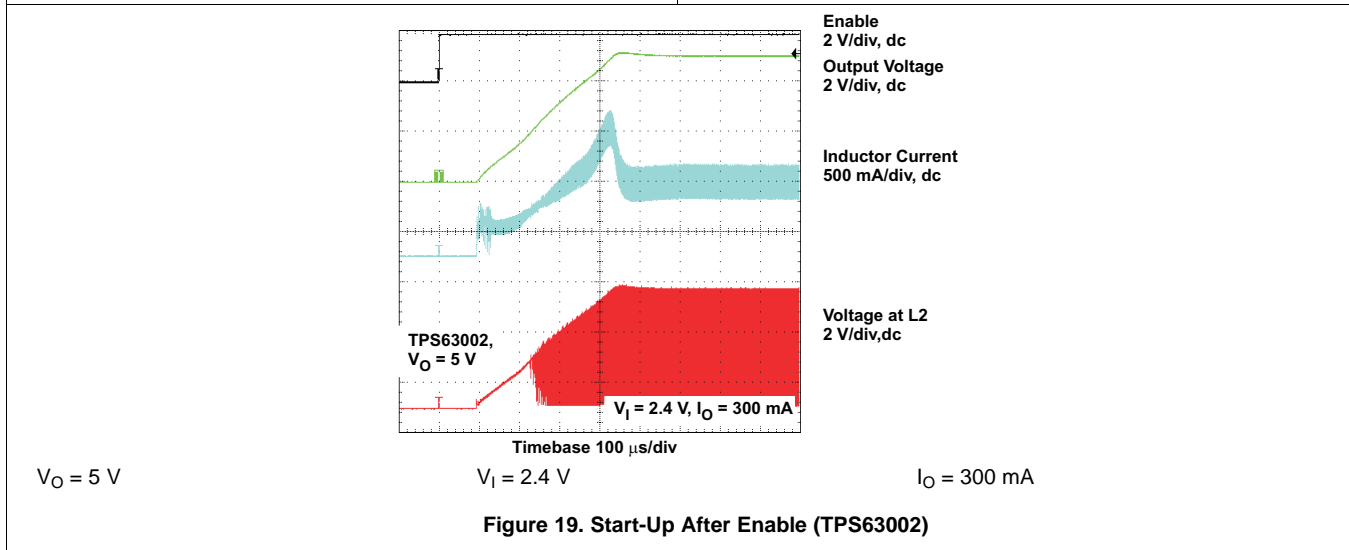
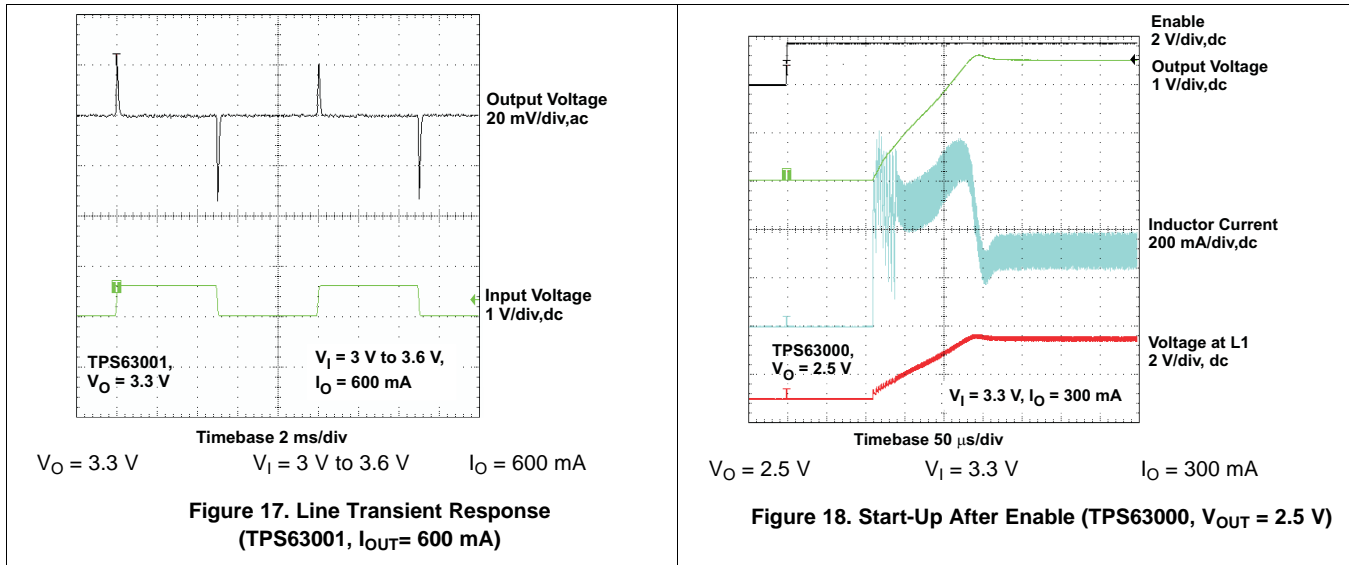

9 Power Supply Recommendations

The TPS6300x devices have no special requirements for its input power supply. The output current of the input power supply needs to be rated according to the supply voltage, output voltage and output current of the TPS6300x.

10 Layout

10.1 Layout Guidelines

As for all switching power supplies, the layout is an important step in the design, especially at high peak currents and high switching frequencies. If the layout is not carefully done, the regulator could show stability problems as well as EMI problems. Therefore, use wide and short traces for the main current path and for the power ground tracks. The input capacitor, output capacitor, and the inductor should be placed as close as possible to the IC. Use a common ground node for power ground and a different one for control ground to minimize the effects of ground noise. Connect these ground nodes at any place close to one of the ground pins of the IC.

The feedback divider should be placed as close as possible to the control ground pin of the IC. To lay out the control ground, TI recommends to use short traces as well, separated from the power ground traces. This avoids ground shift problems, which can occur due to superimposition of power ground current and control ground current.

10.2 Layout Example

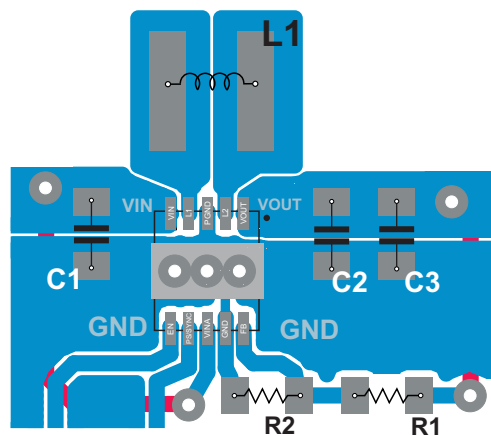

Figure 20. Layout Recommendation

10.3 Thermal Considerations

Implementation of integrated circuits in low-profile and fine-pitch surface-mount packages typically requires special attention to power dissipation. Many system-dependent issues such as thermal coupling, airflow, added heat sinks and convection surfaces, and the presence of other heat-generating components affect the power-dissipation limits of a given component.

Three basic approaches for enhancing thermal performance are listed below:

- Improving the power dissipation capability of the PCB design
- Improving the thermal coupling of the component to the PCB by soldering the exposed thermal pad
- Introducing airflow in the system

The maximum recommended junction temperature (T_J) of the TPS6300x devices is 125°C. The thermal resistance of the 10-pin QFN 3 mm × 3 mm package (DRC) is $R_{\theta JA} = 48.7^\circ\text{C/W}$, if the exposed thermal pad is soldered. Specified regulator operation is assured to a maximum ambient temperature T_A of 85°C. Therefore, the maximum power dissipation is about 820 mW, as calculated in Equation 5. More power can be dissipated if the maximum ambient temperature of the application is lower.

$$P_{D(\text{MAX})} = \frac{T_{J(\text{MAX})} - T_A}{R_{\theta JA}} = \frac{125^\circ\text{C} - 85^\circ\text{C}}{48.7^\circ\text{C/W}} = 820 \text{ mW} \quad (5)$$

11 Device and Documentation Support

11.1 Device Support

11.1.1 Third-Party Products Disclaimer

TI'S PUBLICATION OF INFORMATION REGARDING THIRD-PARTY PRODUCTS OR SERVICES DOES NOT CONSTITUTE AN ENDORSEMENT REGARDING THE SUITABILITY OF SUCH PRODUCTS OR SERVICES OR A WARRANTY, REPRESENTATION OR ENDORSEMENT OF SUCH PRODUCTS OR SERVICES, EITHER ALONE OR IN COMBINATION WITH ANY TI PRODUCT OR SERVICE.

11.2 Related Links

The table below lists quick access links. Categories include technical documents, support and community resources, tools and software, and quick access to sample or buy.

Table 3. Related Links

PARTS	PRODUCT FOLDER	SAMPLE & BUY	TECHNICAL DOCUMENTS	TOOLS & SOFTWARE	SUPPORT & COMMUNITY
TPS63000	Click here	Click here	Click here	Click here	Click here
TPS63001	Click here	Click here	Click here	Click here	Click here
TPS63002	Click here	Click here	Click here	Click here	Click here

11.3 Community Resources

The following links connect to TI community resources. Linked contents are provided "AS IS" by the respective contributors. They do not constitute TI specifications and do not necessarily reflect TI's views; see TI's [Terms of Use](#).

TI E2E™ Online Community *TI's Engineer-to-Engineer (E2E) Community*. Created to foster collaboration among engineers. At e2e.ti.com, you can ask questions, share knowledge, explore ideas and help solve problems with fellow engineers.

Design Support *TI's Design Support* Quickly find helpful E2E forums along with design support tools and contact information for technical support.

11.4 Trademarks

E2E is a trademark of Texas Instruments.
All other trademarks are the property of their respective owners.

11.5 Electrostatic Discharge Caution



These devices have limited built-in ESD protection. The leads should be shorted together or the device placed in conductive foam during storage or handling to prevent electrostatic damage to the MOS gates.

11.6 Glossary

SLYZ022 — *TI Glossary*.

This glossary lists and explains terms, acronyms, and definitions.

12 Mechanical, Packaging, and Orderable Information

The following pages include mechanical, packaging, and orderable information. This information is the most current data available for the designated devices. This data is subject to change without notice and revision of this document. For browser-based versions of this data sheet, refer to the left-hand navigation.

PACKAGING INFORMATION

Orderable Device	Status (1)	Package Type	Package Drawing	Pins	Package Qty	Eco Plan (2)	Lead/Ball Finish (6)	MSL Peak Temp (3)	Op Temp (°C)	Device Marking (4/5)	Samples
TPS63000DRCCR	ACTIVE	VSON	DRC	10	3000	Green (RoHS & no Sb/Br)	CU NIPDAU	Level-2-260C-1 YEAR	-40 to 85	BPT	Samples
TPS63000DRCRG4	ACTIVE	VSON	DRC	10	3000	Green (RoHS & no Sb/Br)	CU NIPDAU	Level-2-260C-1 YEAR	-40 to 85	BPT	Samples
TPS63000DRCT	ACTIVE	VSON	DRC	10	250	Green (RoHS & no Sb/Br)	CU NIPDAU	Level-2-260C-1 YEAR	-40 to 85	BPT	Samples
TPS63000DRCTG4	ACTIVE	VSON	DRC	10	250	Green (RoHS & no Sb/Br)	CU NIPDAU	Level-2-260C-1 YEAR	-40 to 85	BPT	Samples
TPS63001DRCCR	ACTIVE	VSON	DRC	10	3000	Green (RoHS & no Sb/Br)	CU NIPDAU	Level-2-260C-1 YEAR	-40 to 85	BPU	Samples
TPS63001DRCRG4	ACTIVE	VSON	DRC	10	3000	Green (RoHS & no Sb/Br)	CU NIPDAU	Level-2-260C-1 YEAR	-40 to 85	BPU	Samples
TPS63001DRCT	ACTIVE	VSON	DRC	10	250	Green (RoHS & no Sb/Br)	CU NIPDAU	Level-2-260C-1 YEAR	-40 to 85	BPU	Samples
TPS63002DRCCR	ACTIVE	VSON	DRC	10	3000	Green (RoHS & no Sb/Br)	CU NIPDAU	Level-2-260C-1 YEAR	-40 to 85	BPV	Samples
TPS63002DRCT	ACTIVE	VSON	DRC	10	250	Green (RoHS & no Sb/Br)	CU NIPDAU	Level-2-260C-1 YEAR	-40 to 85	BPV	Samples
TPS63002DRCTG4	ACTIVE	VSON	DRC	10	250	Green (RoHS & no Sb/Br)	CU NIPDAU	Level-2-260C-1 YEAR	-40 to 85	BPV	Samples

(1) The marketing status values are defined as follows:

ACTIVE: Product device recommended for new designs.

LIFEBUY: TI has announced that the device will be discontinued, and a lifetime-buy period is in effect.

NRND: Not recommended for new designs. Device is in production to support existing customers, but TI does not recommend using this part in a new design.

PREVIEW: Device has been announced but is not in production. Samples may or may not be available.

OBSOLETE: TI has discontinued the production of the device.

(2) **RoHS:** TI defines "RoHS" to mean semiconductor products that are compliant with the current EU RoHS requirements for all 10 RoHS substances, including the requirement that RoHS substance do not exceed 0.1% by weight in homogeneous materials. Where designed to be soldered at high temperatures, "RoHS" products are suitable for use in specified lead-free processes. TI may reference these types of products as "Pb-Free".

RoHS Exempt: TI defines "RoHS Exempt" to mean products that contain lead but are compliant with EU RoHS pursuant to a specific EU RoHS exemption.

Green: TI defines "Green" to mean the content of Chlorine (Cl) and Bromine (Br) based flame retardants meet JS709B low halogen requirements of <=1000ppm threshold. Antimony trioxide based flame retardants must also meet the <=1000ppm threshold requirement.

(3) MSL, Peak Temp. - The Moisture Sensitivity Level rating according to the JEDEC industry standard classifications, and peak solder temperature.

(4) There may be additional marking, which relates to the logo, the lot trace code information, or the environmental category on the device.

(5) Multiple Device Markings will be inside parentheses. Only one Device Marking contained in parentheses and separated by a "~" will appear on a device. If a line is indented then it is a continuation of the previous line and the two combined represent the entire Device Marking for that device.

(6) Lead/Ball Finish - Orderable Devices may have multiple material finish options. Finish options are separated by a vertical ruled line. Lead/Ball Finish values may wrap to two lines if the finish value exceeds the maximum column width.

Important Information and Disclaimer:The information provided on this page represents TI's knowledge and belief as of the date that it is provided. TI bases its knowledge and belief on information provided by third parties, and makes no representation or warranty as to the accuracy of such information. Efforts are underway to better integrate information from third parties. TI has taken and continues to take reasonable steps to provide representative and accurate information but may not have conducted destructive testing or chemical analysis on incoming materials and chemicals. TI and TI suppliers consider certain information to be proprietary, and thus CAS numbers and other limited information may not be available for release.

In no event shall TI's liability arising out of such information exceed the total purchase price of the TI part(s) at issue in this document sold by TI to Customer on an annual basis.

OTHER QUALIFIED VERSIONS OF TPS63000 :

- Automotive: [TPS63000-Q1](#)

NOTE: Qualified Version Definitions:

- Automotive - Q100 devices qualified for high-reliability automotive applications targeting zero defects

TAPE AND REEL INFORMATION

QUADRANT ASSIGNMENTS FOR PIN 1 ORIENTATION IN TAPE

*All dimensions are nominal

Device	Package Type	Package Drawing	Pins	SPQ	Reel Diameter (mm)	Reel Width W1 (mm)	A0 (mm)	B0 (mm)	K0 (mm)	P1 (mm)	W (mm)	Pin1 Quadrant
TPS63000DRCR	VSON	DRC	10	3000	330.0	12.4	3.3	3.3	1.1	8.0	12.0	Q2
TPS63000DRCT	VSON	DRC	10	250	180.0	12.4	3.3	3.3	1.1	8.0	12.0	Q2
TPS63001DRCR	VSON	DRC	10	3000	330.0	12.4	3.3	3.3	1.1	8.0	12.0	Q2
TPS63001DRCT	VSON	DRC	10	250	180.0	12.4	3.3	3.3	1.1	8.0	12.0	Q2
TPS63002DRCR	VSON	DRC	10	3000	330.0	12.4	3.3	3.3	1.1	8.0	12.0	Q2
TPS63002DRCT	VSON	DRC	10	250	180.0	12.4	3.3	3.3	1.1	8.0	12.0	Q2
TPS63002DRCT	VSON	DRC	10	250	180.0	12.4	3.3	3.3	1.1	8.0	12.0	Q2

TAPE AND REEL BOX DIMENSIONS

*All dimensions are nominal

Device	Package Type	Package Drawing	Pins	SPQ	Length (mm)	Width (mm)	Height (mm)
TPS63000DRCR	VSON	DRC	10	3000	367.0	367.0	35.0
TPS63000DRCT	VSON	DRC	10	250	210.0	185.0	35.0
TPS63001DRCR	VSON	DRC	10	3000	367.0	367.0	35.0
TPS63001DRCT	VSON	DRC	10	250	210.0	185.0	35.0
TPS63002DRCR	VSON	DRC	10	3000	367.0	367.0	35.0
TPS63002DRCT	VSON	DRC	10	250	210.0	185.0	35.0
TPS63002DRCT	VSON	DRC	10	250	210.0	185.0	35.0

GENERIC PACKAGE VIEW

DRC 10

VSON - 1 mm max height

PLASTIC SMALL OUTLINE - NO LEAD

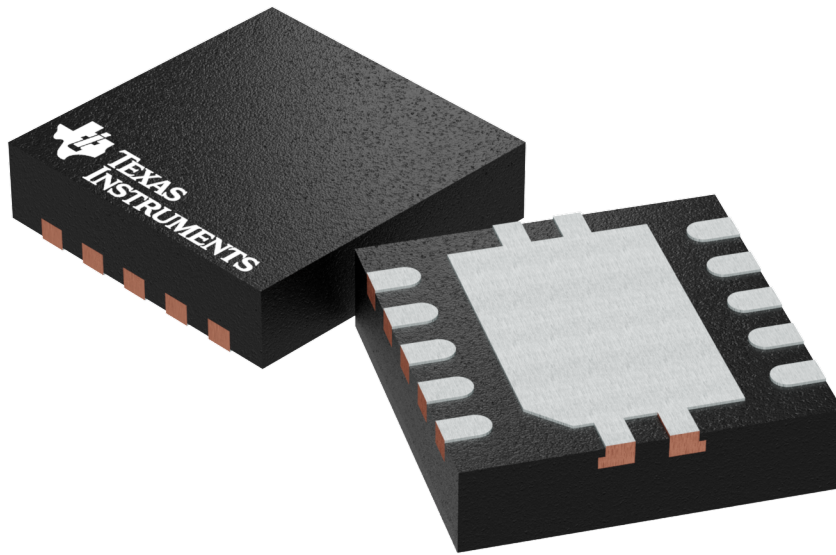

Images above are just a representation of the package family, actual package may vary.
Refer to the product data sheet for package details.

4204102-3/M

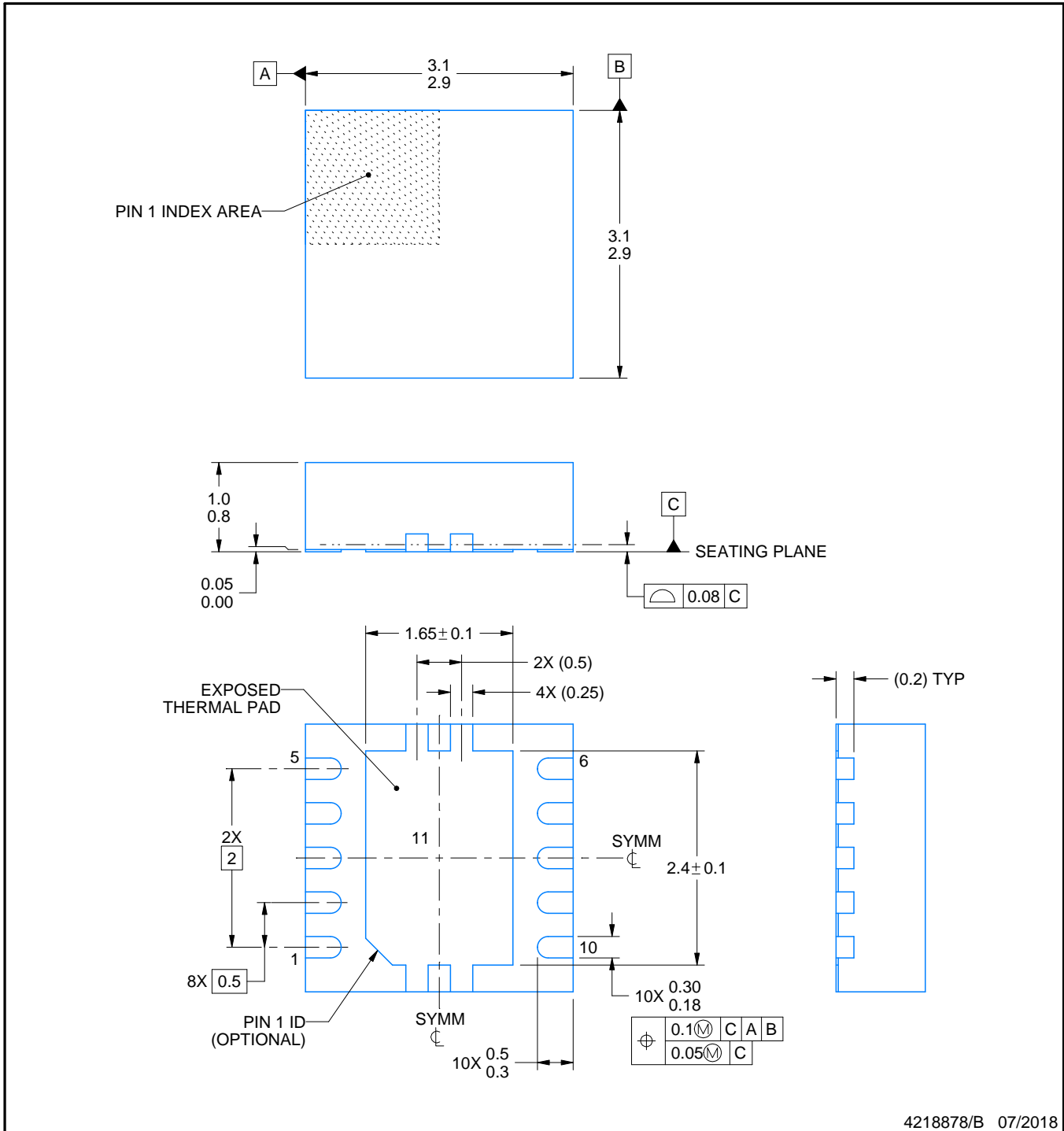

4218878/B 07/2018

NOTES:

1. All linear dimensions are in millimeters. Any dimensions in parenthesis are for reference only. Dimensioning and tolerancing per ASME Y14.5M.
2. This drawing is subject to change without notice.
3. The package thermal pad must be soldered to the printed circuit board for optimal thermal and mechanical performance.

EXAMPLE BOARD LAYOUT

DRC0010J

VSON - 1 mm max height

PLASTIC SMALL OUTLINE - NO LEAD

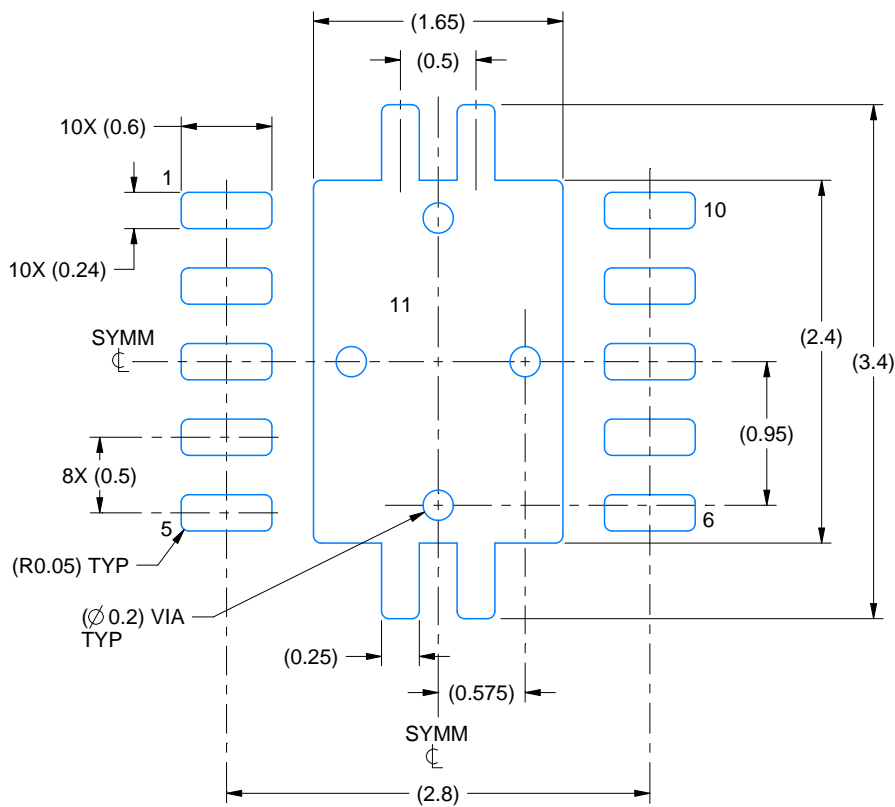

LAND PATTERN EXAMPLE
EXPOSED METAL SHOWN
SCALE:20X

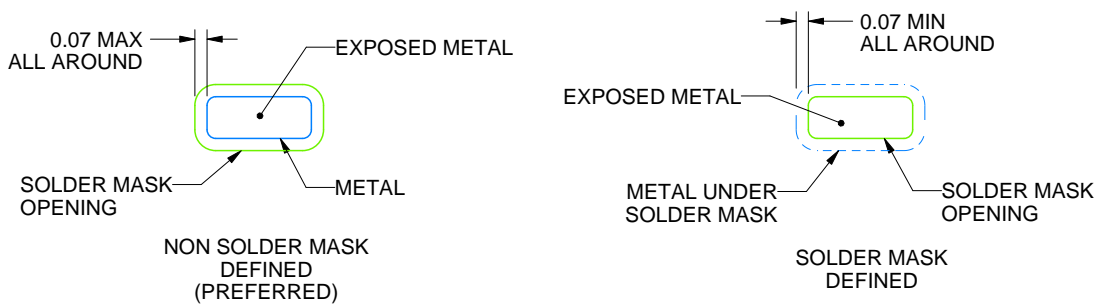

SOLDER MASK DETAILS

4218878/B 07/2018

NOTES: (continued)

4. This package is designed to be soldered to a thermal pad on the board. For more information, see Texas Instruments literature number SLUA271 (www.ti.com/lit/sluea271).
5. Vias are optional depending on application, refer to device data sheet. If any vias are implemented, refer to their locations shown on this view. It is recommended that vias under paste be filled, plugged or tented.

EXAMPLE STENCIL DESIGN

DRC0010J

VSON - 1 mm max height

PLASTIC SMALL OUTLINE - NO LEAD

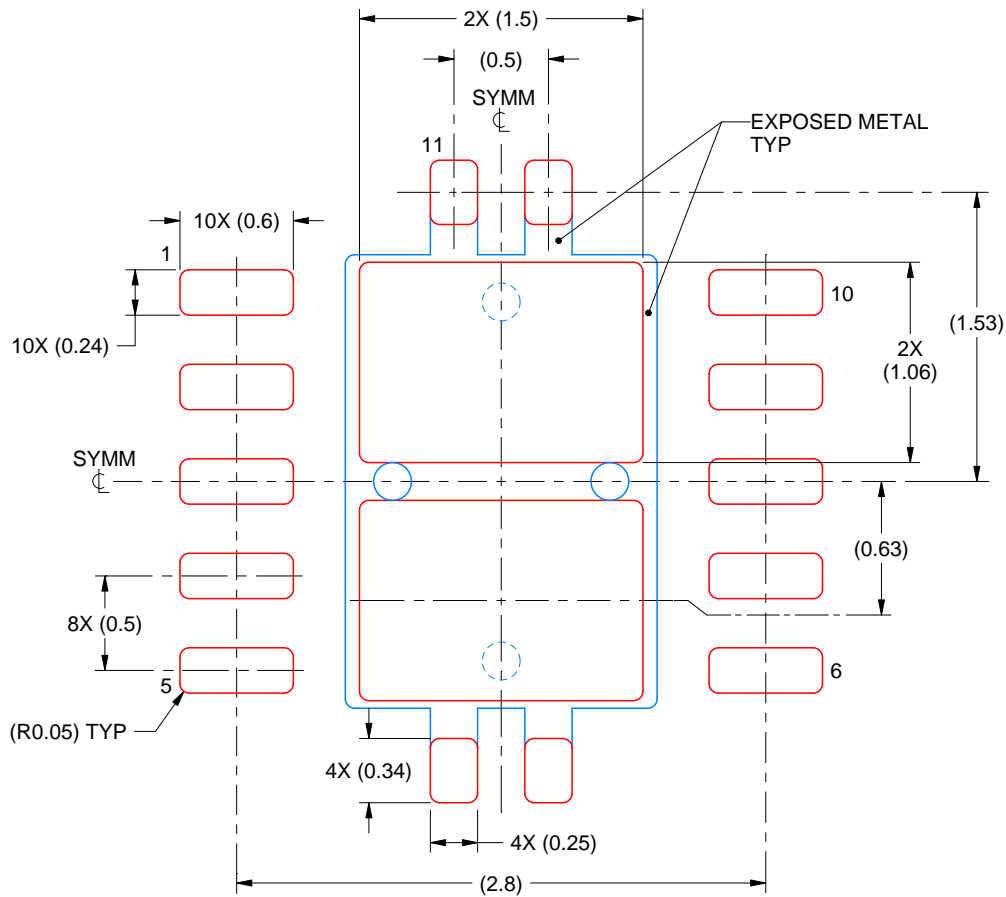

SOLDER PASTE EXAMPLE
BASED ON 0.125 mm THICK STENCIL

EXPOSED PAD 11:
80% PRINTED SOLDER COVERAGE BY AREA
SCALE:25X

4218878/B 07/2018

NOTES: (continued)

6. Laser cutting apertures with trapezoidal walls and rounded corners may offer better paste release. IPC-7525 may have alternate design recommendations.

IMPORTANT NOTICE AND DISCLAIMER

TI PROVIDES TECHNICAL AND RELIABILITY DATA (INCLUDING DATASHEETS), DESIGN RESOURCES (INCLUDING REFERENCE DESIGNS), APPLICATION OR OTHER DESIGN ADVICE, WEB TOOLS, SAFETY INFORMATION, AND OTHER RESOURCES "AS IS" AND WITH ALL FAULTS, AND DISCLAIMS ALL WARRANTIES, EXPRESS AND IMPLIED, INCLUDING WITHOUT LIMITATION ANY IMPLIED WARRANTIES OF MERCHANTABILITY, FITNESS FOR A PARTICULAR PURPOSE OR NON-INFRINGEMENT OF THIRD PARTY INTELLECTUAL PROPERTY RIGHTS.

These resources are intended for skilled developers designing with TI products. You are solely responsible for (1) selecting the appropriate TI products for your application, (2) designing, validating and testing your application, and (3) ensuring your application meets applicable standards, and any other safety, security, or other requirements. These resources are subject to change without notice. TI grants you permission to use these resources only for development of an application that uses the TI products described in the resource. Other reproduction and display of these resources is prohibited. No license is granted to any other TI intellectual property right or to any third party intellectual property right. TI disclaims responsibility for, and you will fully indemnify TI and its representatives against, any claims, damages, costs, losses, and liabilities arising out of your use of these resources.

TI's products are provided subject to TI's Terms of Sale (www.ti.com/legal/termsofsale.html) or other applicable terms available either on ti.com or provided in conjunction with such TI products. TI's provision of these resources does not expand or otherwise alter TI's applicable warranties or warranty disclaimers for TI products.

Mailing Address: Texas Instruments, Post Office Box 655303, Dallas, Texas 75265
Copyright © 2018, Texas Instruments Incorporated

Looking for pricing, stock, or lifecycle information?

Click below to explore more details on WIN SOURCE:

- ⊖ [View TPS63000EVM-148 on WIN SOURCE](#)
- ⊖ [Texas Instruments](#) Information

Optimize Your Supply Chain with WIN SOURCE Solutions

- ✓ Global Sourcing Solution
- ✓ Obsolete Management
- ✓ Cost Control Management
- ✓ Shortage Management
- ✓ Alternative Solution
- ✓ Excess Inventory Management