



**THE DATASHEET OF
TPS3806I33DBVR**



Dual Voltage Detector with Adjustable Hysteresis

FEATURES

- Dual Voltage Detector With Adjustable Hysteresis 3.3-V/Adjustable and 2-V/Adjustable
- Assured Reset at $V_{DD} = 0.8\text{ V}$
- Supply Current: $3\ \mu\text{A}$ Typical at $V_{DD} = 3.3\text{ V}$
- Independent Open-Drain Reset Outputs
- Temperature Range: -40°C to $+85^{\circ}\text{C}$
- 6-Pin SOT-23 Package

DESCRIPTION

The TPS3806 integrates two independent voltage detectors for battery voltage monitoring. During power-on, $\overline{\text{RESET}}$ and $\overline{\text{RSTSENSE}}$ are asserted when supply voltage V_{DD} or the voltage at LSENSE input become higher than 0.8 V. Thereafter, the supervisory circuit monitors V_{DD} and LSENSE, keeping $\overline{\text{RESET}}$ and $\overline{\text{RSTSENSE}}$ active as long as V_{DD} and LSENSE remain below the threshold voltage, V_{IT} . As soon as V_{DD} or LSENSE rise above the threshold voltage V_{IT} , $\overline{\text{RESET}}$ or $\overline{\text{RSTSENSE}}$ is deasserted, respectively. The TPS3806 device has a fixed-sense threshold voltage V_{IT} set by an internal voltage divider at V_{DD} and an adjustable second-LSENSE input. In addition, an upper voltage threshold can be set at HSENSE to allow a wide adjustable hysteresis window.

The devices are available in a 6-pin SOT-23 package. The TPS3806 device is characterized for operation over a temperature range of -40°C to $+85^{\circ}\text{C}$.

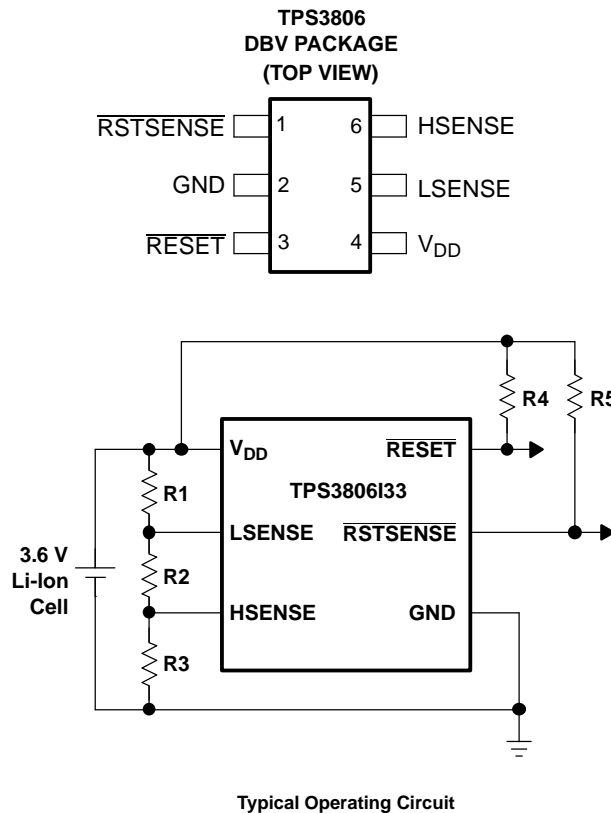

Please be aware that an important notice concerning availability, standard warranty, and use in critical applications of Texas Instruments semiconductor products and disclaimers thereto appears at the end of this data sheet.



This integrated circuit can be damaged by ESD. Texas Instruments recommends that all integrated circuits be handled with appropriate precautions. Failure to observe proper handling and installation procedures can cause damage.

ESD damage can range from subtle performance degradation to complete device failure. Precision integrated circuits may be more susceptible to damage because very small parametric changes could cause the device not to meet its published specifications.

ORDERING INFORMATION⁽¹⁾

T _A	DEVICE NAME		THRESHOLD VOLTAGE		MARKING
			V _{DD}	SENSE	
-40°C to +85°C	TPS3806J20DBVR ⁽²⁾	TPS3806J20DBVT ⁽³⁾	1.8 V	1.207 V	PGQI
	TPS3806I33DBVR ⁽²⁾	TPS3806I33DBVT ⁽³⁾	3 V	1.207 V	PGPI

- (1) For the most current package and ordering information, see the Package Option Addendum located at the end of this data sheet or refer to our web site at www.ti.com.
 (2) The DBVR passive indicates tape and reel containing 3000 parts.
 (3) The DBVT passive indicates tape and reel containing 250 parts.

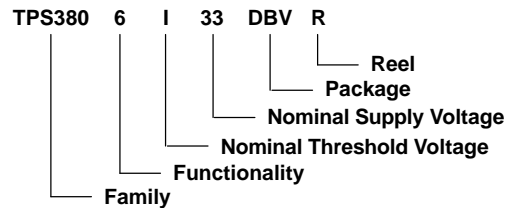

ABSOLUTE MAXIMUM RATINGS

over operating free-air temperature range (unless otherwise noted)⁽¹⁾

	TPS3806J20, TPS3806I33	UNIT
Supply voltage, V _{DD} ⁽²⁾	7	V
All other pins ⁽²⁾	-0.3 to 7	V
Maximum low-output current, I _{OL}	5	mA
Maximum high-output current, I _{OH}	-5	mA
Input clamp current, I _{IK} (V _I < 0 or V _I > V _{DD})	±10	mA
Output clamp current, I _{OK} (V _O < 0 or V _O > V _{DD})	±10	mA
Continuous total power dissipation	See Dissipation Rating Table	
Operating free-air temperature range, T _A	-40 to +85	°C
Storage temperature range, T _{stg}	-65 to +150	°C
Soldering temperature	+260	°C

- (1) Stresses beyond those listed under absolute maximum ratings may cause permanent damage to the device. These are stress ratings only, and functional operation of the device at these or any other conditions beyond those indicated under recommended operating conditions is not implied. Exposure to absolute-maximum-rated conditions for extended periods may affect device reliability.
 (2) All voltage values are with respect to GND. For reliable operation, the device must not be continuously operated at 7 V for more than t = 1000 h.

DISSIPATION RATING TABLE

PACKAGE	T _A < 25°C	DERATING FACTOR ABOVE T _A = 25°C	T _A = 70°C POWER RATING	T _A = 85°C POWER RATING
DBV	437 mW	3.5 mW/°C	280 mW	227 mW

RECOMMENDED OPERATING CONDITIONS

	MIN	MAX	UNIT
Supply voltage, V_{DD}	1.3	6	V
Input voltage, V_I	0	$V_{DD} + 0.3$	V
Operating free-air temperature range, T_A	-40	+85	°C

ELECTRICAL CHARACTERISTICS

over recommended operating free-air temperature range (unless otherwise noted)

PARAMETER		TEST CONDITIONS	MIN	TYP	MAX	UNIT	
V_{OL}	Low-level output voltage	$V_{DD} = 1.5\text{ V}$, $I_{OL} = 1\text{ mA}$					
		$V_{DD} = 3.3\text{ V}$, $I_{OL} = 2\text{ mA}$			0.3	V	
		$V_{DD} = 6\text{ V}$, $I_{OL} = 3\text{ mA}$					
Power-up reset voltage ⁽¹⁾		$V_{DD} \geq 0.8\text{ V}$, $I_{OL} = 50\text{ }\mu\text{A}$			0.2	V	
V_{IT}	Negative-going input threshold voltage ⁽²⁾	LSENSE	$T_A = +25^\circ\text{C}$	1.198	1.207	1.216	V
		TPS3806J20		1.787	1.8	1.813	
		TPS3806I33		2.978	3.0	3.022	
	LSENSE	$T_A = 0^\circ\text{C to } +70^\circ\text{C}$	1.188	1.207	1.226	V	
			TPS3806J20	1.772	1.8		1.828
			TPS3806I33	2.952	3.0		3.048
	LSENSE	$T_A = -40^\circ\text{C to } +85^\circ\text{C}$	1.183	1.207	1.231	V	
			TPS3806J20	1.764	1.8		1.836
			TPS3806I33	2.94	3.0		3.06
V_{hys}	Hysteresis	$1.2\text{ V} < V_{IT} < 2.5\text{ V}$		60		mV	
		$2.5\text{ V} < V_{IT} < 3.5\text{ V}$		90			
I_I	Input current	LSENSE, HSENSE	-25		25	nA	
I_{OH}	High-level output current	$V_{DD} = V_{IT} + 0.2\text{ V}$, $V_{OH} = V_{DD}$			300	nA	
I_{DD}	Supply current	$V_{DD} = 3.3\text{ V}$, Output unconnected		3	5	μA	
		$V_{DD} = 6\text{ V}$, Output unconnected		4	6		
C_i	Input capacitance	$V_I = 0\text{ V to } V_{DD}$		1		pF	

(1) The lowest supply voltage at which RESET becomes active. $t_{r,VDD} \geq 15\text{ }\mu\text{s/V}$

(2) To ensure best stability of the threshold voltage, place a bypass capacitor (ceramic, 0.1 μF) near the supply terminals.

SWITCHING CHARACTERISTICS

at $R_L = 1\text{ M}\Omega$, $C_L = 50\text{ pF}$, $T_A = -40^\circ\text{C to } +85^\circ\text{C}$

PARAMETER		TEST CONDITIONS	MIN	TYP	MAX	UNIT
t_{PHL}	Propagation (delay) time, high-to-low-level output	V_{DD} to RESET delay	$V_{IH} = 1.05 \times V_{IT}$, $V_{IL} = 0.95 \times V_{IT}$	5	100	μs
		LSENSE to $\overline{\text{RSTSENSE}}$ delay				
t_{PLH}	Propagation (delay) time, low-to-high-level output	V_{DD} to RESET delay				
		HSENSE to $\overline{\text{RSTSENSE}}$ delay				

TIMING REQUIREMENTS

at $R_L = 1\text{ M}\Omega$, $C_L = 50\text{ pF}$, $T_A = -40^\circ\text{C to } +85^\circ\text{C}$

PARAMETER		TEST CONDITIONS	MIN	TYP	MAX	UNIT
t_w	Pulse width	At V_{DD}	$V_{IH} = 1.05 \times V_{IT}$, $V_{IL} = 0.95 \times V_{IT}$	5.5		μs
		At SENSE				

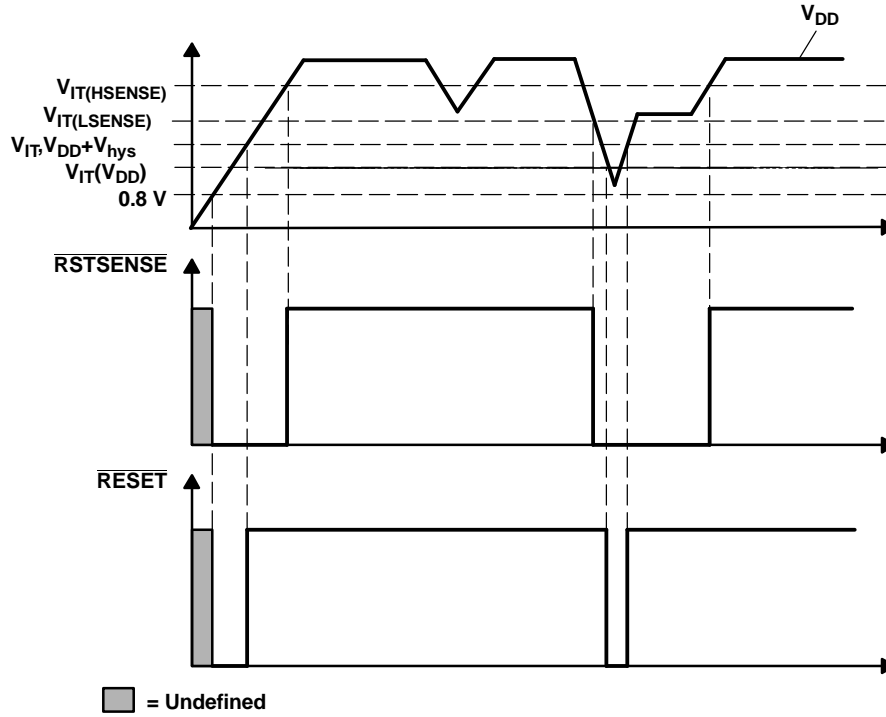

Table 1. TERMINAL FUNCTIONS

TERMINAL		I/O	DESCRIPTION
NAME	NO.		
GND	2	I	Ground
HSENSE	6	I	Adjustable hysteresis input
LSENSE	5	I	Adjustable sense input
\overline{RESET}	3	O	Active-low open drain reset output (from V_{DD})
$\overline{RSTSENSE}$	1	O	Active-low open-drain reset output (from LSENSE)
V_{DD}	4	I	Input supply voltage and fixed sense input

FUNCTION/TRUTH TABLE

TPS3806			
$V_{DD} > V_{IT}$	\overline{RESET}	LSENSE > V_{IT}	$\overline{RSTSENSE}$
0	L	0	L
1	H	1	H

FUNCTIONAL BLOCK DIAGRAM

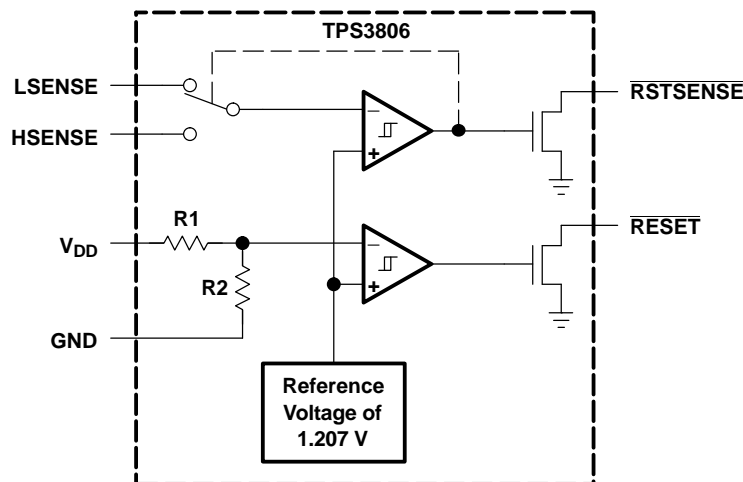

Detailed Description

Operation

The TPS3806 is used for monitoring battery voltage and asserting $\overline{\text{RESET}}$ when a battery gets discharged below a certain threshold voltage. The battery voltage is monitored by a comparator via an external resistor divider. When the voltage at the LSENSE input drops below the internal reference voltage the $\overline{\text{RSTSENSE}}$ output pulls low. The output remains low until the battery is replaced, or recharged above a second higher trip-point, set at HSENSE. A second voltage can be monitored at V_{DD} . The independent $\overline{\text{RESET}}$ output pulls low when the voltage at V_{DD} drops below the fixed threshold voltage. Because the TPS3806 outputs are open-drain MOSFETs, most applications may require a pull-up resistor.

Programming the Threshold Voltage Levels

The low-voltage threshold at LSENSE is calculated according to Equation 1:

$$V_{(\text{LSENSE})} = V_{\text{ref}} \left(\frac{R1 + R2 + R3}{R2 + R3} \right) \quad (1)$$

where $V_{\text{ref}} = 1.207 \text{ V}$

The high-voltage threshold at HSENSE is calculated as shown in Equation 2:

$$V_{(\text{HSENSE})} = V_{\text{ref}} \left(\frac{R1 + R2 + R3}{R3} \right) \quad (2)$$

where $V_{\text{ref}} = 1.207 \text{ V}$

To minimize battery current draw it is recommended to use 1-M Ω as the total resistor value $R_{(\text{tot})}$, with $R_{(\text{tot})} = R1 + R2 + R3$.

TYPICAL CHARACTERISTICS

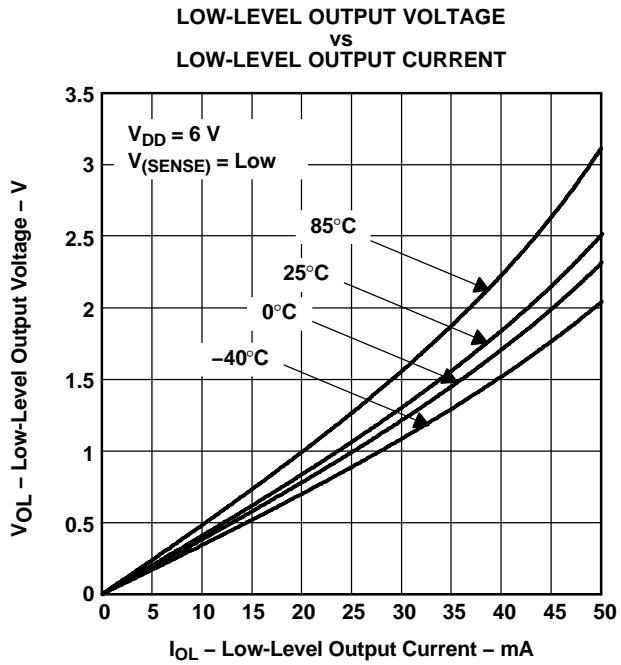
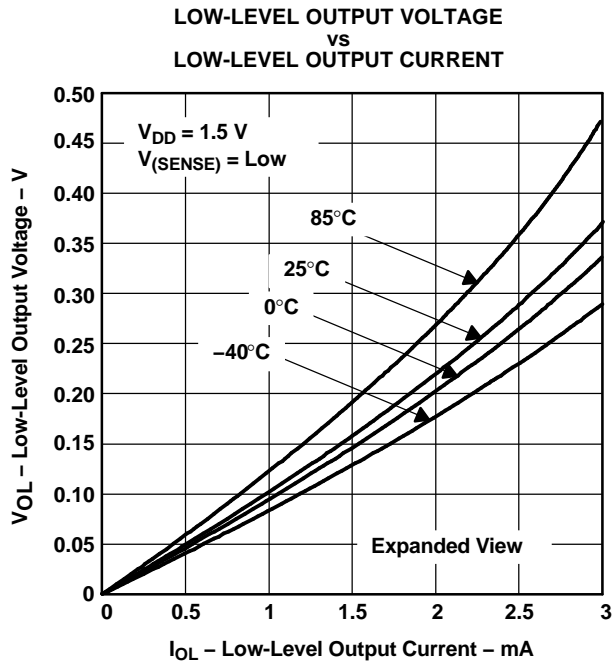
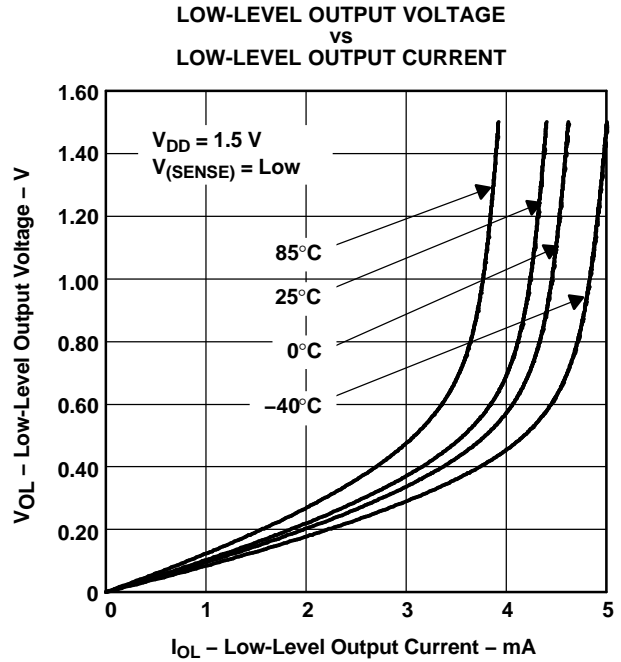
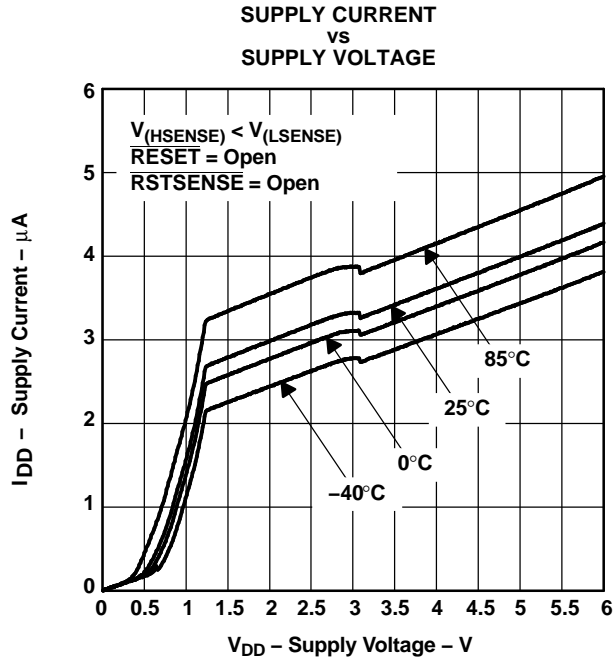

TYPICAL CHARACTERISTICS (continued)

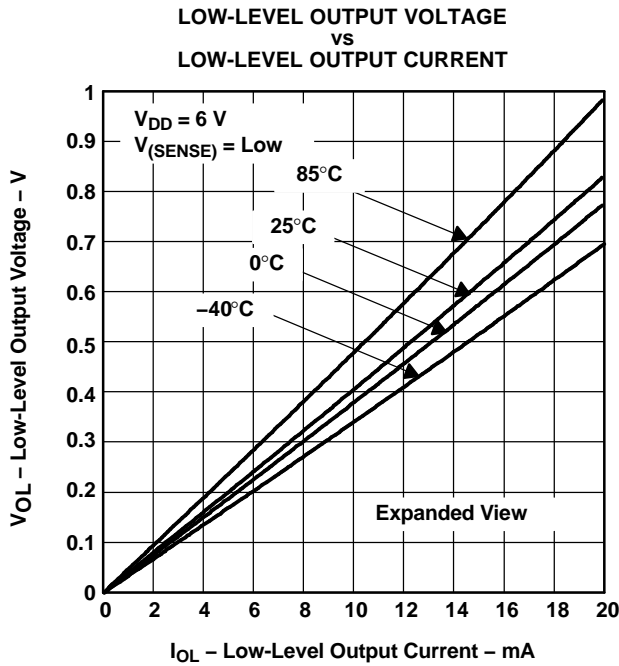

Figure 5.

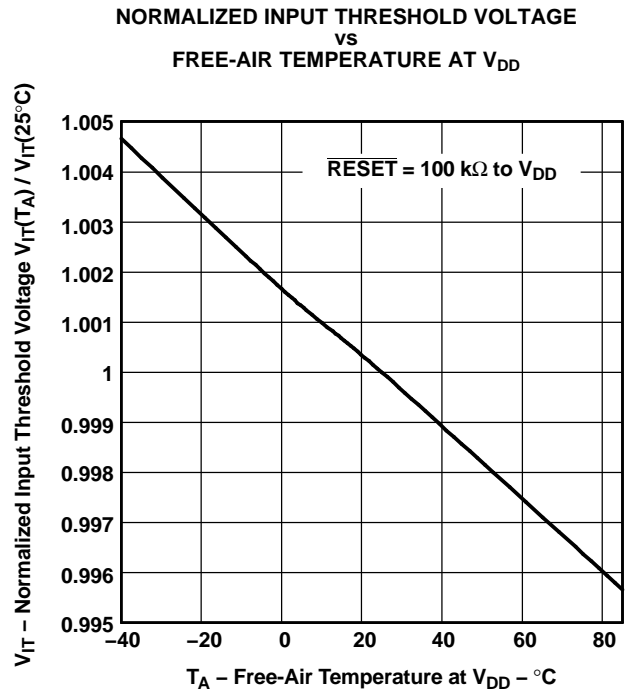

Figure 6.

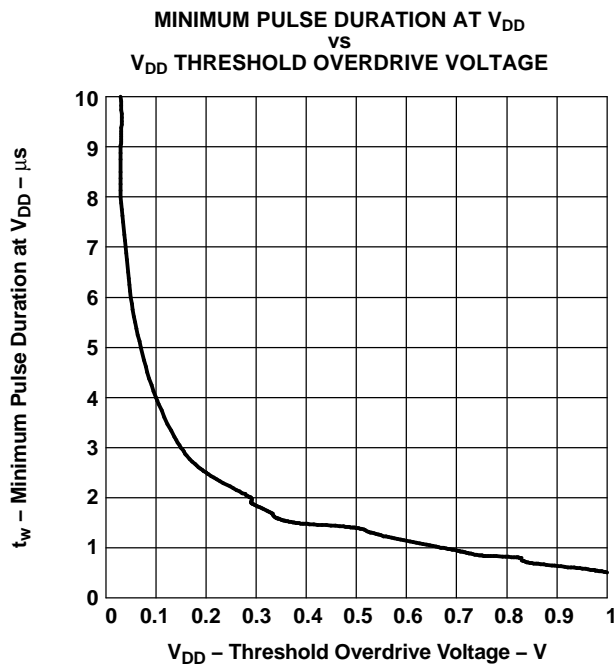

Figure 7.

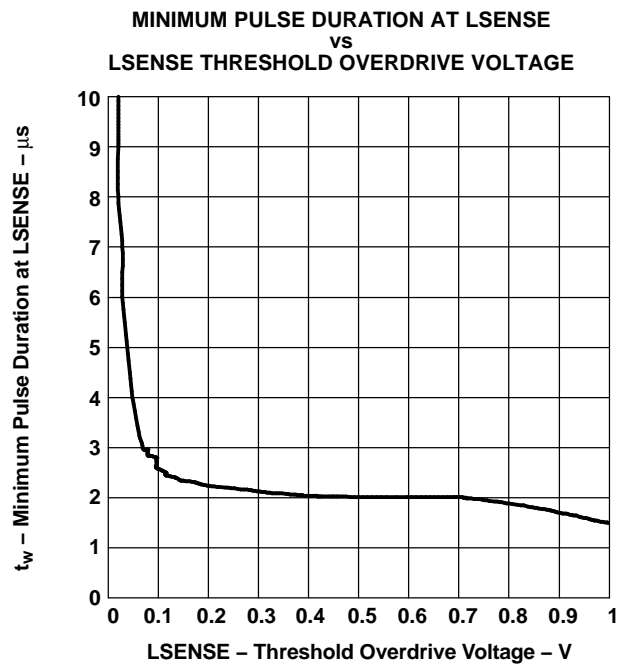

Figure 8.

PACKAGING INFORMATION

Orderable Device	Status (1)	Package Type	Package Drawing	Pins	Package Qty	Eco Plan (2)	Lead finish/ Ball material (6)	MSL Peak Temp (3)	Op Temp (°C)	Device Marking (4/5)	Samples
TPS3806I33DBVR	ACTIVE	SOT-23	DBV	6	3000	RoHS & Green	NIPDAU	Level-1-260C-UNLIM	-40 to 85	PGPI	Samples
TPS3806I33DBVT	ACTIVE	SOT-23	DBV	6	250	RoHS & Green	NIPDAU	Level-1-260C-UNLIM	-40 to 85	PGPI	Samples
TPS3806J20DBVR	ACTIVE	SOT-23	DBV	6	3000	RoHS & Green	NIPDAU	Level-1-260C-UNLIM	-40 to 85	PGQI	Samples
TPS3806J20DBVT	ACTIVE	SOT-23	DBV	6	250	RoHS & Green	NIPDAU	Level-1-260C-UNLIM	-40 to 85	PGQI	Samples

(1) The marketing status values are defined as follows:

ACTIVE: Product device recommended for new designs.

LIFEBUY: TI has announced that the device will be discontinued, and a lifetime-buy period is in effect.

NRND: Not recommended for new designs. Device is in production to support existing customers, but TI does not recommend using this part in a new design.

PREVIEW: Device has been announced but is not in production. Samples may or may not be available.

OBSOLETE: TI has discontinued the production of the device.

(2) **RoHS:** TI defines "RoHS" to mean semiconductor products that are compliant with the current EU RoHS requirements for all 10 RoHS substances, including the requirement that RoHS substance do not exceed 0.1% by weight in homogeneous materials. Where designed to be soldered at high temperatures, "RoHS" products are suitable for use in specified lead-free processes. TI may reference these types of products as "Pb-Free".

RoHS Exempt: TI defines "RoHS Exempt" to mean products that contain lead but are compliant with EU RoHS pursuant to a specific EU RoHS exemption.

Green: TI defines "Green" to mean the content of Chlorine (Cl) and Bromine (Br) based flame retardants meet JS709B low halogen requirements of <=1000ppm threshold. Antimony trioxide based flame retardants must also meet the <=1000ppm threshold requirement.

(3) MSL, Peak Temp. - The Moisture Sensitivity Level rating according to the JEDEC industry standard classifications, and peak solder temperature.

(4) There may be additional marking, which relates to the logo, the lot trace code information, or the environmental category on the device.

(5) Multiple Device Markings will be inside parentheses. Only one Device Marking contained in parentheses and separated by a "-" will appear on a device. If a line is indented then it is a continuation of the previous line and the two combined represent the entire Device Marking for that device.

(6) Lead finish/Ball material - Orderable Devices may have multiple material finish options. Finish options are separated by a vertical ruled line. Lead finish/Ball material values may wrap to two lines if the finish value exceeds the maximum column width.

Important Information and Disclaimer:The information provided on this page represents TI's knowledge and belief as of the date that it is provided. TI bases its knowledge and belief on information provided by third parties, and makes no representation or warranty as to the accuracy of such information. Efforts are underway to better integrate information from third parties. TI has taken and

continues to take reasonable steps to provide representative and accurate information but may not have conducted destructive testing or chemical analysis on incoming materials and chemicals. TI and TI suppliers consider certain information to be proprietary, and thus CAS numbers and other limited information may not be available for release.

In no event shall TI's liability arising out of such information exceed the total purchase price of the TI part(s) at issue in this document sold by TI to Customer on an annual basis.

TAPE AND REEL INFORMATION

QUADRANT ASSIGNMENTS FOR PIN 1 ORIENTATION IN TAPE

*All dimensions are nominal

Device	Package Type	Package Drawing	Pins	SPQ	Reel Diameter (mm)	Reel Width W1 (mm)	A0 (mm)	B0 (mm)	K0 (mm)	P1 (mm)	W (mm)	Pin1 Quadrant
TPS3806I33DBVR	SOT-23	DBV	6	3000	180.0	8.4	3.2	3.2	1.4	4.0	8.0	Q3
TPS3806I33DBVR	SOT-23	DBV	6	3000	178.0	9.0	3.23	3.17	1.37	4.0	8.0	Q3
TPS3806I33DBVT	SOT-23	DBV	6	250	180.0	8.4	3.2	3.2	1.4	4.0	8.0	Q3
TPS3806I33DBVT	SOT-23	DBV	6	250	178.0	9.0	3.23	3.17	1.37	4.0	8.0	Q3
TPS3806J20DBVR	SOT-23	DBV	6	3000	178.0	9.0	3.23	3.17	1.37	4.0	8.0	Q3
TPS3806J20DBVT	SOT-23	DBV	6	250	178.0	9.0	3.23	3.17	1.37	4.0	8.0	Q3

TAPE AND REEL BOX DIMENSIONS

*All dimensions are nominal

Device	Package Type	Package Drawing	Pins	SPQ	Length (mm)	Width (mm)	Height (mm)
TPS3806I33DBVR	SOT-23	DBV	6	3000	200.0	183.0	25.0
TPS3806I33DBVR	SOT-23	DBV	6	3000	180.0	180.0	18.0
TPS3806I33DBVT	SOT-23	DBV	6	250	200.0	183.0	25.0
TPS3806I33DBVT	SOT-23	DBV	6	250	180.0	180.0	18.0
TPS3806J20DBVR	SOT-23	DBV	6	3000	180.0	180.0	18.0
TPS3806J20DBVT	SOT-23	DBV	6	250	180.0	180.0	18.0

EXAMPLE BOARD LAYOUT

DBV0006A

SOT-23 - 1.45 mm max height

SMALL OUTLINE TRANSISTOR

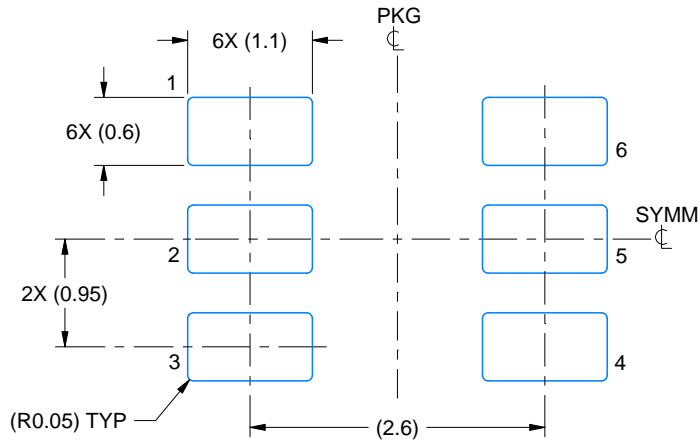

LAND PATTERN EXAMPLE
EXPOSED METAL SHOWN
SCALE:15X

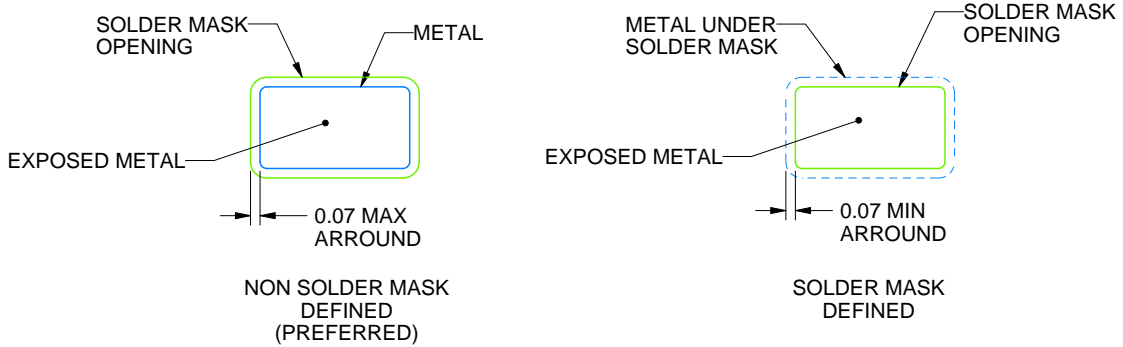

SOLDER MASK DETAILS

4214840/E 02/2024

NOTES: (continued)

- 6. Publication IPC-7351 may have alternate designs.
- 7. Solder mask tolerances between and around signal pads can vary based on board fabrication site.

EXAMPLE STENCIL DESIGN

DBV0006A

SOT-23 - 1.45 mm max height

SMALL OUTLINE TRANSISTOR

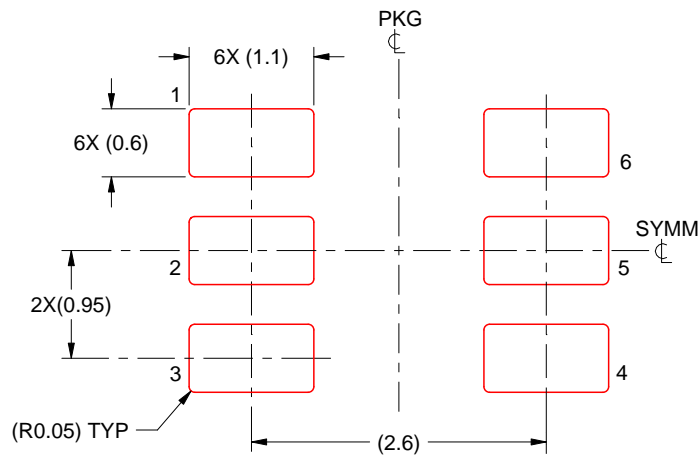

SOLDER PASTE EXAMPLE
BASED ON 0.125 mm THICK STENCIL
SCALE:15X

4214840/E 02/2024

NOTES: (continued)

8. Laser cutting apertures with trapezoidal walls and rounded corners may offer better paste release. IPC-7525 may have alternate design recommendations.
9. Board assembly site may have different recommendations for stencil design.

IMPORTANT NOTICE AND DISCLAIMER

TI PROVIDES TECHNICAL AND RELIABILITY DATA (INCLUDING DATA SHEETS), DESIGN RESOURCES (INCLUDING REFERENCE DESIGNS), APPLICATION OR OTHER DESIGN ADVICE, WEB TOOLS, SAFETY INFORMATION, AND OTHER RESOURCES "AS IS" AND WITH ALL FAULTS, AND DISCLAIMS ALL WARRANTIES, EXPRESS AND IMPLIED, INCLUDING WITHOUT LIMITATION ANY IMPLIED WARRANTIES OF MERCHANTABILITY, FITNESS FOR A PARTICULAR PURPOSE OR NON-INFRINGEMENT OF THIRD PARTY INTELLECTUAL PROPERTY RIGHTS.

These resources are intended for skilled developers designing with TI products. You are solely responsible for (1) selecting the appropriate TI products for your application, (2) designing, validating and testing your application, and (3) ensuring your application meets applicable standards, and any other safety, security, regulatory or other requirements.

These resources are subject to change without notice. TI grants you permission to use these resources only for development of an application that uses the TI products described in the resource. Other reproduction and display of these resources is prohibited. No license is granted to any other TI intellectual property right or to any third party intellectual property right. TI disclaims responsibility for, and you will fully indemnify TI and its representatives against, any claims, damages, costs, losses, and liabilities arising out of your use of these resources.

TI's products are provided subject to [TI's Terms of Sale](#) or other applicable terms available either on [ti.com](https://www.ti.com) or provided in conjunction with such TI products. TI's provision of these resources does not expand or otherwise alter TI's applicable warranties or warranty disclaimers for TI products.

TI objects to and rejects any additional or different terms you may have proposed.

Mailing Address: Texas Instruments, Post Office Box 655303, Dallas, Texas 75265
Copyright © 2024, Texas Instruments Incorporated

Looking for pricing, stock, or lifecycle information?

Click below to explore more details on WIN SOURCE:

 [View TPS3806I33DBVR](#) on WIN SOURCE

 [Texas Instruments](#) Information

Optimize Your Supply Chain with WIN SOURCE Solutions

-  Global Sourcing Solution
-  Obsolete Management
-  Cost Control Management
-  Shortage Management
-  Alternative Solution
-  Excess Inventory Management