



# THE DATASHEET OF TPS2330IPW



# SINGLE HOT-SWAP POWER CONTROLLERS WITH CIRCUIT BREAKER AND POWER-GOOD REPORTING

Check for Samples: [TPS2330](#), [TPS2331](#)

## FEATURES

- Single-Channel High-Side MOSFET Driver
- Input Voltage: 3 V to 13 V
- Output dV/dt Control Limits Inrush Current
- Circuit-Breaker With Programmable Overcurrent Threshold and Transient Timer
- Power-Good Reporting With Transient Filter
- CMOS- and TTL-Compatible Enable Input
- Low 5- $\mu$ A Standby Supply Current (Max)
- Available in 14-Pin SOIC and TSSOP Package
- -40°C to 85°C Ambient Temperature Range
- Electrostatic Discharge Protection

## APPLICATIONS

- Hot-Swap/Plug/Dock Power Management
- Hot-Plug PCI, Device Bay
- Electronic Circuit Breaker

## DESCRIPTION

The TPS2330 and TPS2331 are single-channel hot-swap controllers that use external N-channel MOSFETs as high-side switches in power applications. Features of these devices, such as overcurrent protection (OCP), inrush-current control, output-power status reporting, and the ability to discriminate between load transients and faults, are critical requirements for hot-swap applications.

The TPS2330/31 devices incorporate undervoltage lockout (UVLO) and power-good (PG) reporting to ensure the device is off at start-up and confirm the status of the output voltage rails during operation. An internal charge pump, capable of driving multiple MOSFETs, provides enough gate-drive voltage to fully enhance the N-channel MOSFETs. The charge pump controls both the rise times and fall times (dV/dt) of the MOSFETs, reducing power transients during power up/down. The circuit-breaker functionality combines the ability to sense overcurrent conditions with a timer function; this allows designs such as DSPs, that may have high peak currents during power-state transitions, to disregard transients for a programmable period.

**Table 1. AVAILABLE OPTIONS**

T <sub>A</sub>	HOT-SWAP CONTROLLER DESCRIPTION	PIN COUNT	PACKAGES <sup>(1)</sup>	
			ENABLE	ENABLE
-40°C to 85°C	Dual-channel with independent OCP and adjustable PG	20	TPS2300IPW	TPS2301IPW
	Dual-channel with interdependent OCP and adjustable PG	20	TPS2310IPW	TPS2311IPW
	Dual-channel with independent OCP	16	TPS2320ID TPS2320IPW	TPS2321ID TPS2321IPW
	Single-channel with OCP and adjustable PG	14	TPS2330ID TPS2330IPW	TPS2331ID TPS2331IPW

(1) The packages are available left-end taped and reeled (indicated by the R suffix on the device type; e.g., TPS2331IPWR).

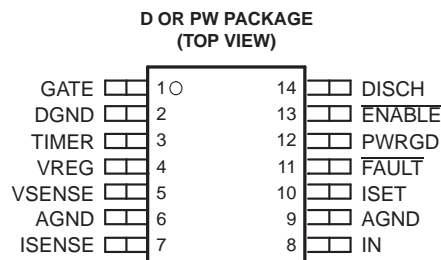

NOTE: Terminal 13 is active-high on TPS2331.

### typical application

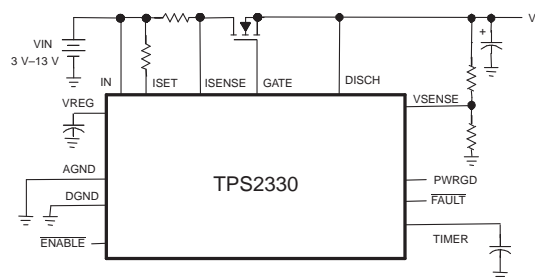

Please be aware that an important notice concerning availability, standard warranty, and use in critical applications of Texas Instruments semiconductor products and disclaimers thereto appears at the end of this data sheet.

FUNCTIONAL BLOCK DIAGRAM

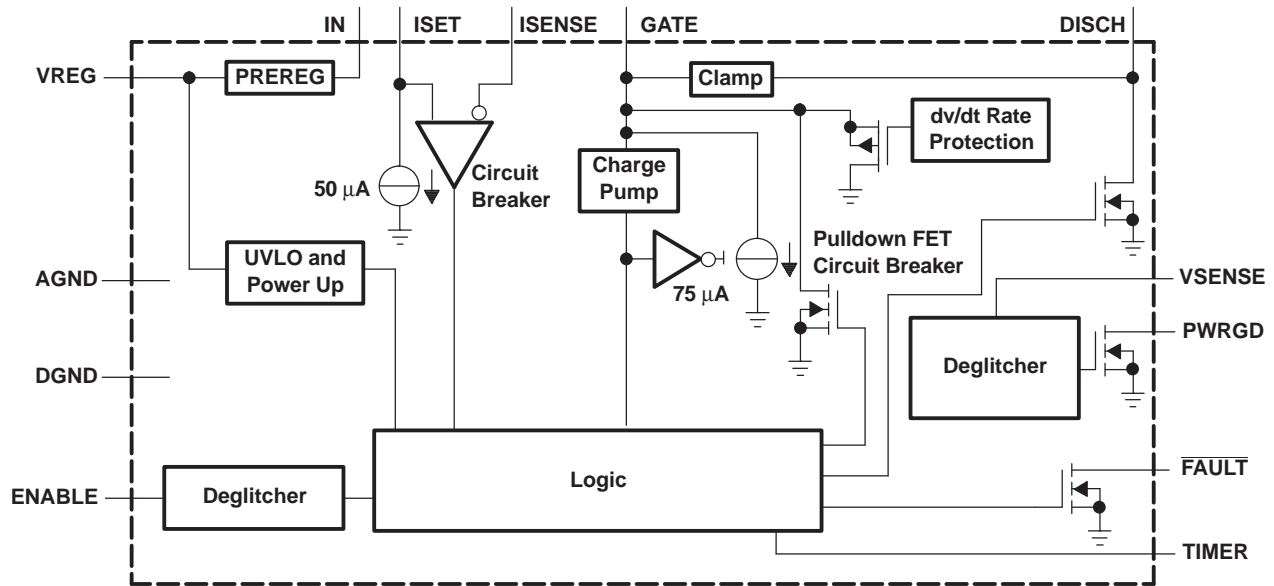

Table 2. Terminal Functions

TERMINAL NAME	NO.	I/O	DESCRIPTION
AGND	6, 9	I	Analog ground, connects to DGND as close as possible
DGND	2	I	Digital ground
DISCH	14	O	Discharge transistor
$\overline{\text{ENABLE}}$ /ENABLE	13	I	Active-low (TPS2330) or active-high enable (TPS2331)
$\overline{\text{FAULT}}$	11	O	Overcurrent fault, open-drain output
GATE	1	O	Connects to gate of high-side MOSFET
IN	8	I	Input voltage
ISENSE	7	I	Current-sense input
ISET	10	I	Adjusts circuit-breaker threshold with resistor connected to IN
PWRGD	12	O	Open-drain output, asserted low when VSENSE voltage is less than reference.
TIMER	3	O	Adjusts circuit-breaker deglitch time
VREG	4	O	Connects to bypass capacitor, for stable operation
VSENSE	5	I	Power-good sense input

## DETAILED DESCRIPTION

**DISCH** – DISCH should be connected to the source of the external N-channel MOSFET transistor connected to GATE. This pin discharges the load when the MOSFET transistor is disabled. They also serve as reference-voltage connection for internal gate-voltage-clamp circuitry.

**ENABLE or ENABLE** –  $\overline{\text{ENABLE}}$  for TPS2330 is active-low. ENABLE for TPS2331 is active-high. When the controller is enabled, GATE voltage powers up to turn on the external MOSFETs. When the  $\overline{\text{ENABLE}}$  pin is pulled high for TPS2330 or the ENABLE pin is pulled low for TPS2331 for more than 50  $\mu\text{s}$ , the gate of the MOSFET is discharged at a controlled rate by a current source, and a transistor is enabled to discharge the output bulk capacitance. In addition, the device turns on the internal regulator PREREG (see VREG) when enabled and shuts down PREREG when disabled so that total supply current is much less than 5  $\mu\text{A}$ .

**FAULT** –  $\overline{\text{FAULT}}$  is an open-drain overcurrent flag output. When an overcurrent condition is sustained long enough to charge TIMER to 0.5 V, the device latches off and pulls  $\overline{\text{FAULT}}$  low. In order to turn the device back on, either the enable pin must be toggled or the input power must be cycled.

**GATE** – GATE connects to the gate of the external N-channel MOSFET transistor. When the device is enabled, internal charge-pump circuitry pulls this pin up by sourcing approximately 15  $\mu\text{A}$ . The turnon slew rates depend on the capacitance present at the GATE terminal. If desired, the turnon slew rates can be further reduced by connecting capacitors between this pin and ground. These capacitors also reduce inrush current and protect the device from false overcurrent triggering during power up. The charge-pump circuitry generates gate-to-source voltages of 9 V–12 V across the external MOSFET transistor.

**IN** – IN should be connected to the power source driving the external N-channel MOSFET transistor connected to GATE. The TPS2330/31 draws its operating current from IN, and remains disabled until the IN power supply has been established. The device has been constructed to support 3-V, 5-V, or 12-V operation.

**ISENSE, ISET** – ISENSE in combination with ISET implements overcurrent sensing for GATE. ISET sets the magnitude of the current that generates an overcurrent fault, through an external resistor connected to ISET. An internal current source draws 50  $\mu\text{A}$  from ISET. With a sense resistor from IN to ISENSE, which is also connected to the drain of the external MOSFET, the voltage on the sense resistor reflects the load current. An overcurrent condition is assumed to exist if ISENSE is pulled below ISET. To ensure proper circuit breaker operation,  $V_{I(\text{ISENSE})}$  and  $V_{I(\text{ISET})}$  should never exceed  $V_{I(\text{IN})}$ .

**PWRGD** – PWRGD signals the presence of undervoltage conditions on VSENSE. The pin is an open-drain output and is pulled low during an undervoltage condition. To minimize erroneous PWRGD responses from transients on the voltage rail, the voltage sense circuit incorporates a 20- $\mu\text{s}$  deglitch filter. When VSENSE is lower than the reference voltage (about 1.23 V), PWRGD is active-low to indicate an undervoltage condition on the power-rail voltage. PWRGD may not correctly report power conditions when the device is disabled because there is no gate drive power for the PWRGD output transistor in the disable mode, or, in other words, PWRGD is floating. Therefore, PWRGD is pulled up to its pullup power supply rail in disable mode.

**TIMER** – A capacitor on TIMER sets the time during which the power switch can be in overcurrent before turning off. When the overcurrent protection circuits sense an excessive current, a current source is enabled which charges the capacitor on TIMER. Once the voltage on TIMER reaches approximately 0.5 V, the circuit-breaker latch is set and the power switch is latched off. Power must be recycled or the ENABLE pin must be toggled to restart the controller. In high-power or high-temperature applications, a minimum 50-pF capacitor is strongly recommended from TIMER to ground, to prevent any false triggering.

**VREG** – VREG is the output of an internal low-dropout voltage regulator, where IN1 is the input. The regulator is used to generate a regulated voltage source, less than 5.5 V, for the device. A 0.1- $\mu\text{F}$  ceramic capacitor should be connected between VREG and ground to aid in noise rejection. In this configuration, on disabling the device, the internal low-dropout regulator also is disabled, which removes power from the internal circuitry and allows the device to be placed in low-quiescent-current mode. In applications where IN1 is less than 5.5 V, VREG and IN1 may be connected together. However, under these conditions, disabling the device may not place the device in low-quiescent-current mode, because the internal low-dropout voltage regulator is being bypassed, thereby keeping internal circuitry operational. If VREG and IN1 are connected together, a 0.1- $\mu\text{F}$  ceramic capacitor between VREG and ground is not needed if IN1 already has a bypass capacitor of 1  $\mu\text{F}$  to 10  $\mu\text{F}$ .

**VSENSE** – VSENSE can be used to detect undervoltage conditions on external circuitry. If VSENSE senses a voltage below approximately 1.23 V, PWRGD is pulled low.

## ABSOLUTE MAXIMUM RATINGS

over operating free-air temperature range (unless otherwise noted) <sup>(1)</sup> <sup>(2)</sup>

		VALUE	UNIT
Input voltage range	$V_{I(IN1)}, V_{I(ISENSE)}, V_{I(VSENSE)}, V_{I(ISET)}, V_{I(ENABLE)}$	-0.3 to 15	V
	$V_{I(VREG)}$	-0.3 to 7	V
Output voltage range	$V_{O(GATE)}$	-0.3 to 30	V
	$V_{O(DISCH)}, V_{O(PWRGD)}, V_{O(\overline{FAULT})}, V_{O(TIMER)}$	-0.3 to 15	V
Sink current range	$I_{(GATE)}, I_{(DISCH)}$	0 to 100	mA
	$I_{(PWRGD)}, I_{(TIMER)}, I_{(\overline{FAULT})}$	0 to 10	mA
Operating virtual junction temperature range, $T_J$		-40 to 100	°C
Storage temperature range, $T_{stg}$		-55 to 150	°C
Lead temperature 1,6 mm (1/16 inch) from case for 10 seconds		260	°C

- (1) Stresses beyond those listed under *absolute maximum ratings* may cause permanent damage to the device. These are stress ratings only, and functional operation of the device at these or any other conditions beyond those indicated under *recommended operating conditions* is not implied. Exposure to absolute-maximum-rated conditions for extended periods may affect device reliability.
- (2) All voltages are with respect to DGND.

## DISSIPATION RATING TABLE

PACKAGE	$T_A \leq 25^\circ\text{C}$ POWER RATING	DERATING FACTOR ABOVE $T_A = 25^\circ\text{C}$	$T_A = 70^\circ\text{C}$ POWER RATING	$T_A = 85^\circ\text{C}$ POWER RATING
PW-14	755 mW	10.07 mW/°C	302 mW	151 mW
D-14	613 mW	8.18 mW/°C	245 mW	123 mW

## RECOMMENDED OPERATING CONDITIONS

		MIN	NOM	MAX	UNIT
$V_I$	Input voltage	$V_{I(IN)}, V_{I(ISENSE)}, V_{I(VSENSE)}, V_{I(ISET)}$		3	13
		$V_{I(VREG)}$		3	5.5
		$V_{I(ISENSE)}, V_{I(ISET)}, V_{I(VSENSE)}$		$V_{I(IN)}$	
$T_J$	Operating virtual junction temperature	-40		100	°C

## ELECTRICAL CHARACTERISTICS

over recommended operating temperature range ( $-40^{\circ}\text{C} < T_A < 85^{\circ}\text{C}$ ),  $3\text{V} \leq V_{I(IN1)} \leq 13\text{V}$ ,  $3\text{V} \leq V_{I(IN2)} \leq 5.5\text{V}$  (unless otherwise noted)

PARAMETER		TEST CONDITIONS		MIN	TYP	MAX	UNIT
<b>GENERAL</b>							
$I_{I(IN)}$	Input current, IN	$V_{I(ENABLE)} = 5\text{V}$ (TPS2331), $V_{I(ENABLE)} = 0\text{V}$ (TPS2330)			0.5	1	mA
$I_{I(stby)}$	Standby current (sum of currents into IN, ISENSE, and ISET)	$V_{I(ENABLE)} = 0\text{V}$ (TPS2331), $V_{I(ENABLE)} = 5\text{V}$ (TPS2330)				5	$\mu\text{A}$
<b>GATE</b>							
$V_{G(GATE\_3V)}$	Gate voltage	$I_{I(GATE)} = 500\text{ nA}$ , DISCH open	$V_{I(IN)} = 3\text{V}$	9	11.5		V
$V_{G(GATE\_4.5V)}$			$V_{I(IN)} = 4.5\text{V}$	10.5	14.5		
$V_{G(GATE\_10.8V)}$			$V_{I(IN)} = 10.8\text{V}$	16.8	21		
$V_{C(GATE)}$	Clamping voltage, GATE to DISCH			9	10	12	V
$I_{S(GATE)}$	Source current, GATE	$3\text{V} \leq V_{I(IN)} \leq 13.2\text{V}$ , $3\text{V} \leq V_{O(VREG)} \leq 5.5\text{V}$ , $V_{I(GATE)} = V_{I(IN)} + 6\text{V}$		10	14	20	$\mu\text{A}$
	Sink current, GATE	$3\text{V} \leq V_{I(IN)} \leq 13.2\text{V}$ , $3\text{V} \leq V_{O(VREG)} \leq 5.5\text{V}$ , $V_{I(GATE)} = V_{I(IN)}$		50	75	100	$\mu\text{A}$
$t_{r(GATE)}$	Rise time, GATE	$C_g$ to GND = 1 nF <sup>(1)</sup>	$V_{I(IN)} = 3\text{V}$	0.5			ms
			$V_{I(IN)} = 4.5\text{V}$	0.6			
			$V_{I(IN)} = 10.8\text{V}$	1			
$t_{f(GATE)}$	Fall time, GATE	$C_g$ to GND = 1 nF <sup>(1)</sup>	$V_{I(IN)} = 3\text{V}$	0.1			ms
			$V_{I(IN)} = 4.5\text{V}$	0.12			
			$V_{I(IN)} = 10.8\text{V}$	0.2			
<b>TIMER</b>							
$V_{(TO\_TIMER)}$	Threshold voltage, TIMER			0.4	0.5	0.6	V
	Charge current, TIMER	$V_{I(TIMER)} = 0\text{V}$		35	50	65	$\mu\text{A}$
	Discharge current, TIMER	$V_{I(TIMER)} = 1\text{V}$		1	2.5		mA
<b>CIRCUIT BREAKER</b>							
$V_{IT(CB)}$	Threshold voltage, circuit breaker	$R_{ISET} = 1\text{ k}\Omega$		40	50	60	mV
		$R_{ISET} = 400\ \Omega$ , $T_A = 25^{\circ}\text{C}$		14	19	24	
		$R_{ISET} = 1\text{ k}\Omega$ , $T_A = 25^{\circ}\text{C}$		44	50	53	
		$R_{ISET} = 1.5\text{ k}\Omega$ , $T_A = 25^{\circ}\text{C}$		68	73	78	
$I_{IB\_ISENSE}$	Input bias current, ISENSE				0.1	5	$\mu\text{A}$
	Discharge current, GATE	$V_{O(GATE)} = 4\text{V}$		400	800		mA
		$V_{O(GATE)} = 1\text{V}$		25	150		
$t_{pd(CB)}$	Propagation (delay) time, comparator inputs to gate output	$C_g = 50\text{ pF}$ , (50% to 10%),	10-mV overdrive, $C_{TIMER} = 50\text{ pF}$	1.3			$\mu\text{s}$
<b>ENABLE, ACTIVE LOW (TPS2330)</b>							
$V_{IH(ENABLE)}$	High-level input voltage, $\overline{\text{ENABLE}}$			2			V
$V_{IL(ENABLE)}$	Low-level input voltage, $\overline{\text{ENABLE}}$					0.8	V
$R_{I(ENABLE)}$	Input pullup resistance, $\overline{\text{ENABLE}}$	See <sup>(2)</sup>		100	200	300	k $\Omega$
$t_{d(off\_ENABLE)}$	Turnoff delay time, $\overline{\text{ENABLE}}$	$V_{I(ENABLE)}$ increasing above stop threshold; 100 ns rise time, 20 mV overdrive <sup>(1)</sup>		60			$\mu\text{s}$
$t_{d(on\_ENABLE)}$	Turnon delay time, $\overline{\text{ENABLE}}$	$V_{I(ENABLE)}$ decreasing below start threshold; 100 ns fall time, 20 mV overdrive <sup>(1)</sup>		125			$\mu\text{s}$

(1) Specified, but not production tested.

(2) Test  $I_O$  of  $\overline{\text{ENABLE}}$  at  $V_{I(ENABLE)} = 1\text{V}$  and  $0\text{V}$ , then  $R_{I(ENABLE)} = \frac{1\text{V}}{I_{O\_0V} - I_{O\_1V}}$

## ELECTRICAL CHARACTERISTICS (Continued)

over recommended operating temperature range ( $-40^{\circ}\text{C} < T_A < 85^{\circ}\text{C}$ ),  $3\text{ V} \leq V_{I(IN1)} \leq 13\text{ V}$ ,  $3\text{ V} \leq V_{I(IN2)} \leq 5.5\text{ V}$  (unless otherwise noted)

PARAMETER		TEST CONDITIONS	MIN	TYP	MAX	UNIT
<b>ENABLE, ACTIVE HIGH (TPS2331)</b>						
$V_{IH(ENABLE)}$	High-level input voltage, ENABLE		2			V
$V_{IL(ENABLE)}$	Low-level input voltage, ENABLE				0.7	V
$R_{I(ENABLE)}$	Input pulldown resistance, ENABLE		100	150	300	k $\Omega$
$t_{d(on\_ENABLE)}$	Turnon delay time, ENABLE	$V_{I(ENABLE)}$ increasing above start threshold; 100-ns rise time, 20-mV overdrive <sup>(1)</sup>		85		$\mu\text{s}$
$t_{d(off\_ENABLE)}$	Turnoff delay time, ENABLE	$V_{I(ENABLE)}$ decreasing below stop threshold; 100-ns fall time, 20-mV overdrive <sup>(1)</sup>		100		$\mu\text{s}$
<b>PREREG</b>						
$V_{(VREG)}$	PREREG output voltage	$4.5 \leq V_{I(IN)} \leq 13\text{ V}$	3.5	4.1	5.5	V
$V_{(drop\_PREREG)}$	PREREG dropout voltage	$V_{I(IN)} = 3\text{ V}$			0.1	V
<b>VREG UVLO</b>						
$V_{(TO\_UVLOstart)}$	Output threshold voltage, start		2.75	2.85	2.95	V
$V_{(TO\_UVLOstop)}$	Output threshold voltage, stop		2.65	2.78		V
$V_{hys(UVLO)}$	Hysteresis		50	75		mV
	UVLO sink current, GATE	$V_{I(GATE)} = 2\text{ V}$	10			mA
<b>PWRGD1 and PWRGD2</b>						
$V_{IT(ISENSE)}$	Trip threshold, VSENSE	$V_{I(VSENSE)}$ decreasing	1.2	1.22 5	1.25	V
$V_{hys}$	Hysteresis voltage, power-good comparator		20	30	40	mV
$V_{O(sat\_PWRGD)}$	Output saturation voltage, PWRGD	$I_O = 2\text{ mA}$		0.2	0.4	V
$V_{O(VREG\_min)}$	Minimum $V_{O(VREG)}$ for valid power-good	$I_O = 100\text{ }\mu\text{A}$ , $V_{O(PWRGD)} = 1\text{ V}$			1	V
	Input bias current, power-good comparator	$V_{I(VSENSE)} = 5.5\text{ V}$			1	$\mu\text{A}$
$I_{lkg(PWRGD)}$	Leakage current, PWRGD	$V_{O(PWRGD)} = 13\text{ V}$			1	$\mu\text{A}$
$t_{dr}$	Delay time, rising edge, PWRGD	$V_{I(VSENSE)}$ increasing, overdrive = 20 mV, $t_r = 100\text{ ns}^{(1)}$		25		$\mu\text{s}$
$t_{df}$	Delay time, falling edge, PWRGDx	$V_{I(VSENSEx)}$ decreasing, overdrive = 20 mV, $t_r = 100\text{ ns}^{(1)}$		2		$\mu\text{s}$
<b>FAULT OUTPUT</b>						
$V_{O(sat\_FAULT)}$	Output saturation voltage, $\overline{\text{FAULT}}$	$I_O = 2\text{ mA}$			0.4	V
$I_{lkg(\overline{\text{FAULT}})}$	Leakage current, $\overline{\text{FAULT}}$	$V_{O(\overline{\text{FAULT}})} = 13\text{ V}$			1	$\mu\text{A}$
<b>DISCH</b>						
$I_{(DISCH)}$	Discharge current, DISCH	$V_{I(DISCH)} = 1.5\text{ V}$ , $V_{I(VIN)} = 5\text{ V}$	5	10		mA
$V_{IH(DISCH)}$	Discharge on high-level input voltage		2			V
$V_{IL(DISCH)}$	Discharge on low-level input voltage				1	V

(1) Specified, but not production tested.

PARAMETER MEASUREMENT INFORMATION

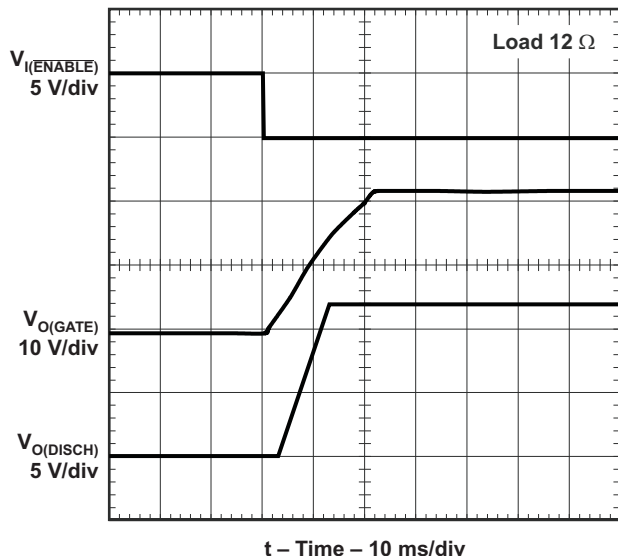

Figure 1. Turnon Voltage Transition

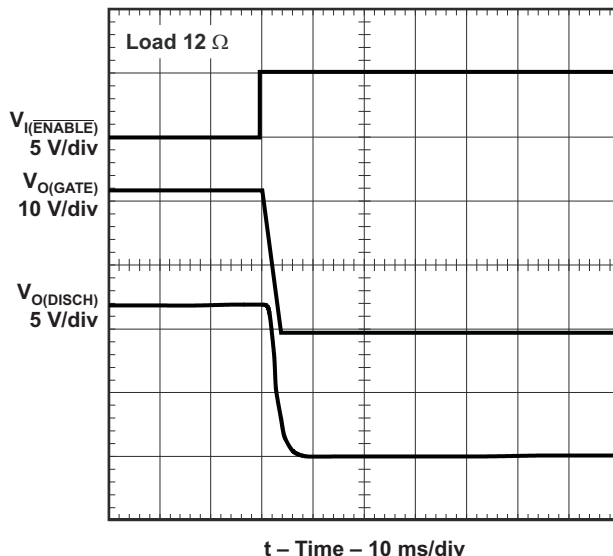

Figure 2. Turnoff Voltage Transition

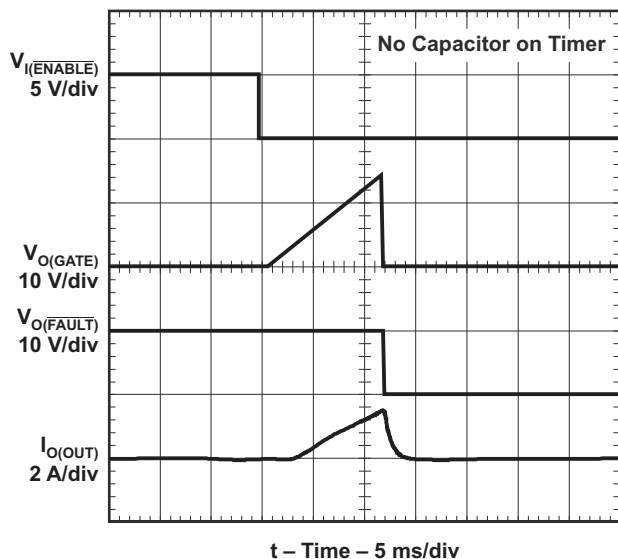

Figure 3. Overcurrent Response: Enabled Into Overcurrent Load

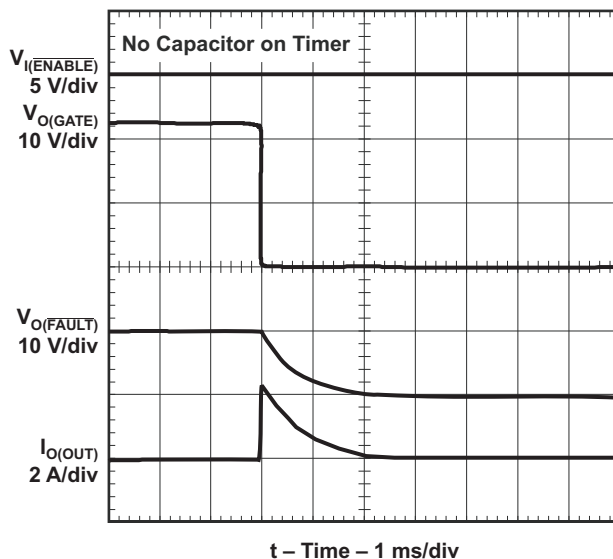

Figure 4. Overcurrent Response: an Overcurrent Load Plugged Into the Enabled Board

PARAMETER MEASUREMENT INFORMATION (continued)

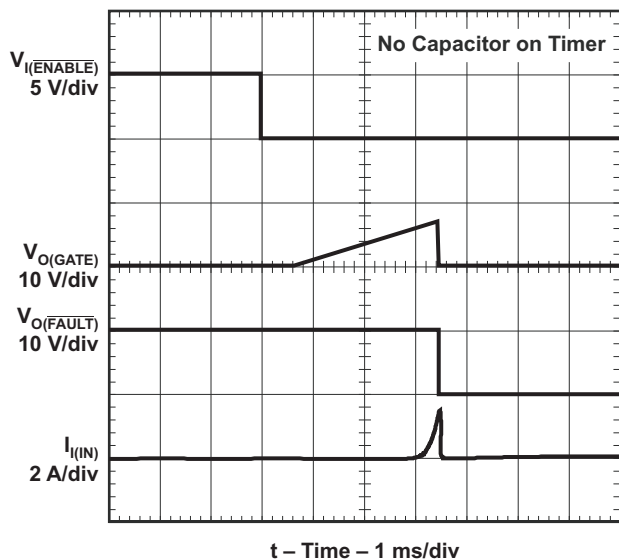

Figure 5. Enabled Into Short Circuit

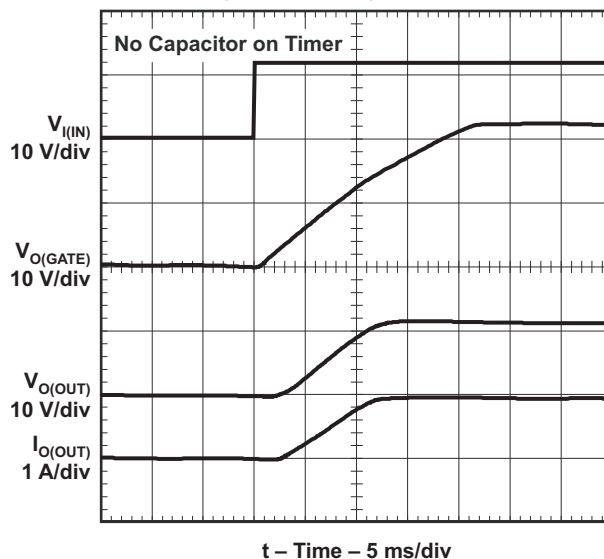

Figure 6. Hot Plug

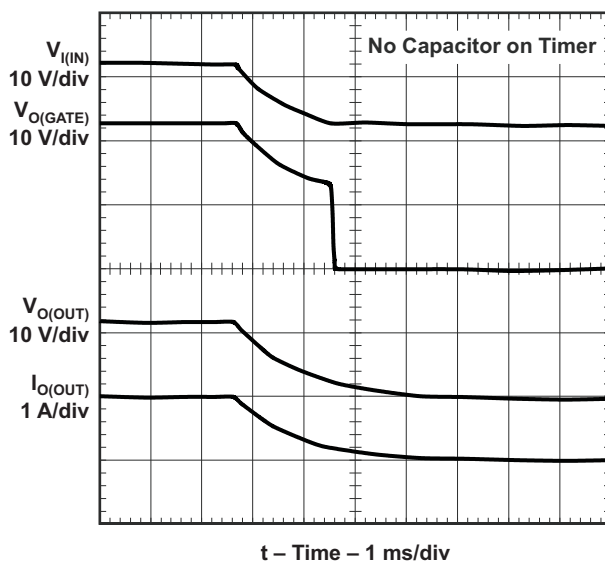

Figure 7. Hot Removal

TYPICAL CHARACTERISTICS

INPUT CURRENT (ENABLED)  
vs  
INPUT VOLTAGE

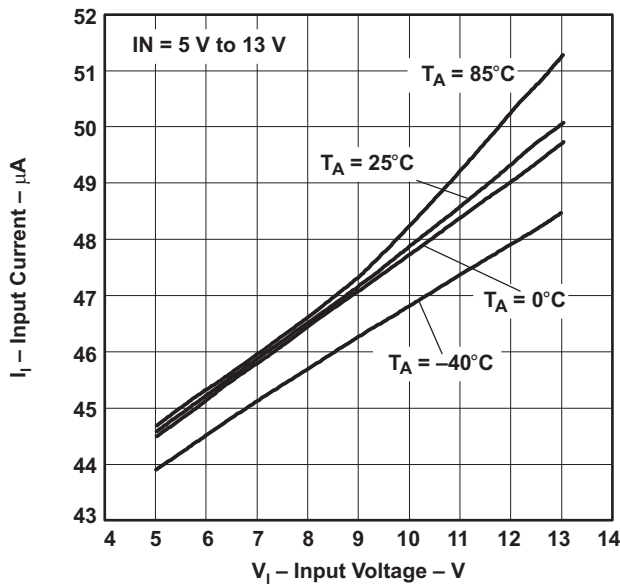

Figure 8.

INPUT CURRENT (DISABLED)  
vs  
INPUT VOLTAGE

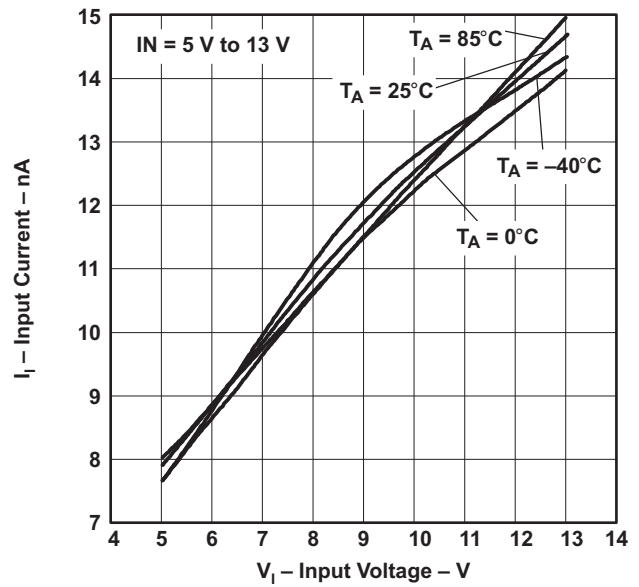

Figure 9.

GATE OUTPUT VOLTAGE  
vs  
INPUT VOLTAGE

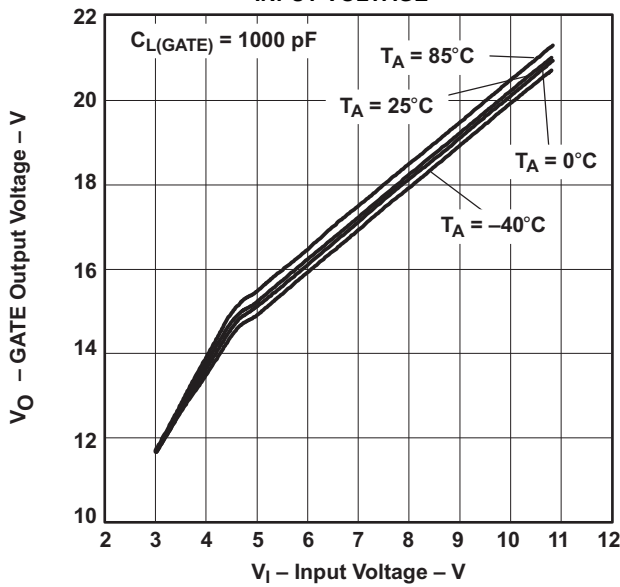

Figure 10.

GATE VOLTAGE RISE TIME  
vs  
GATE LOAD CAPACITANCE

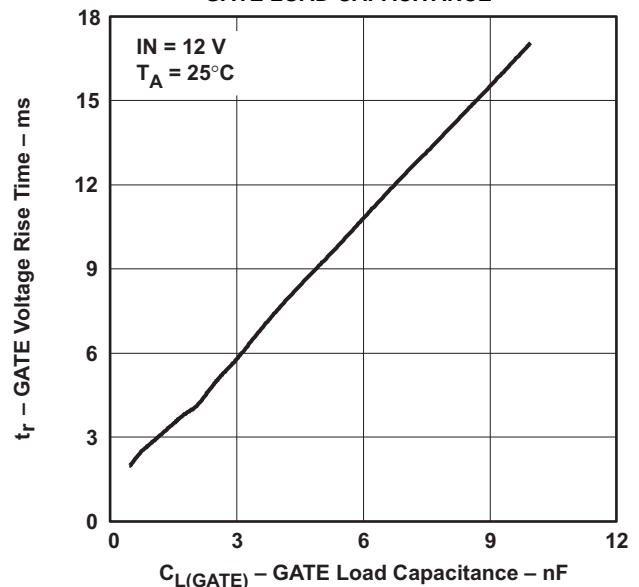

Figure 11.

**TYPICAL CHARACTERISTICS (continued)**

**GATE VOLTAGE FALL TIME  
VS  
GATE LOAD CAPACITANCE**

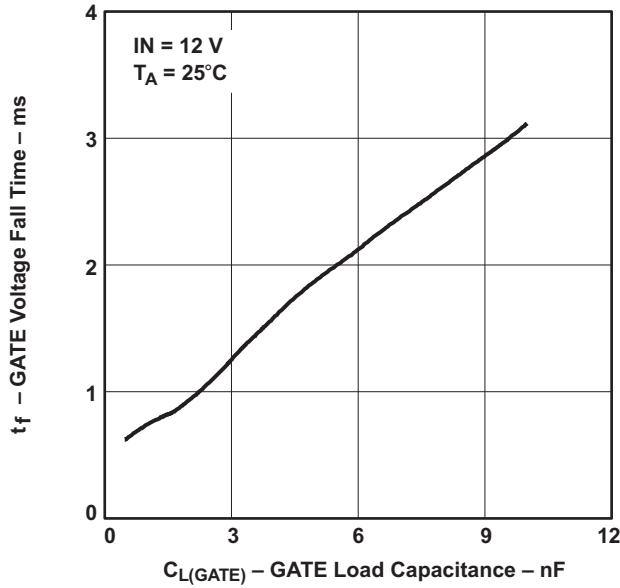

Figure 12.

**GATE OUTPUT CURRENT  
VS  
GATE VOLTAGE**

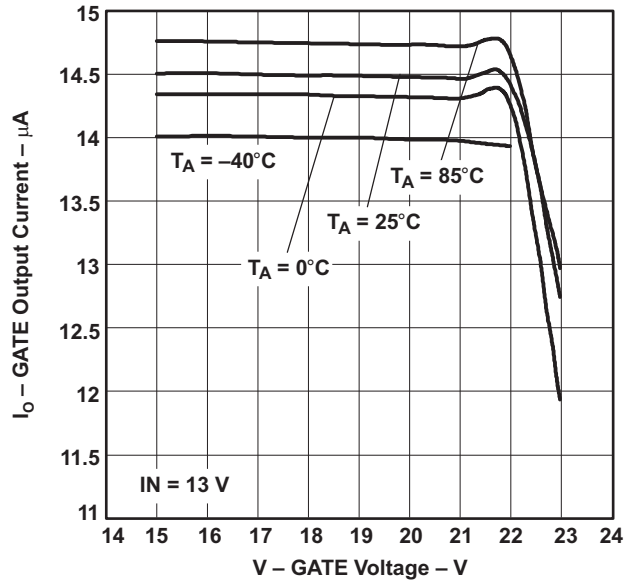

Figure 13.

**CIRCUIT-BREAKER RESPONSE TIME  
VS  
TIMER CAPACITANCE**

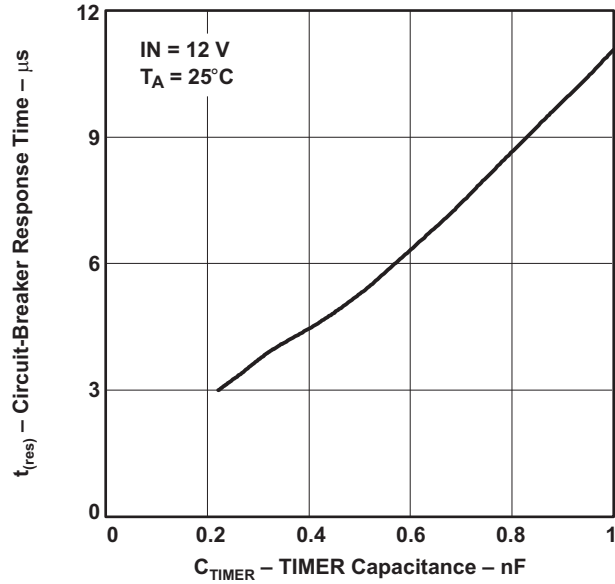

Figure 14.

**LOAD VOLTAGE DISCHARGE TIME  
VS  
LOAD CAPACITANCE**

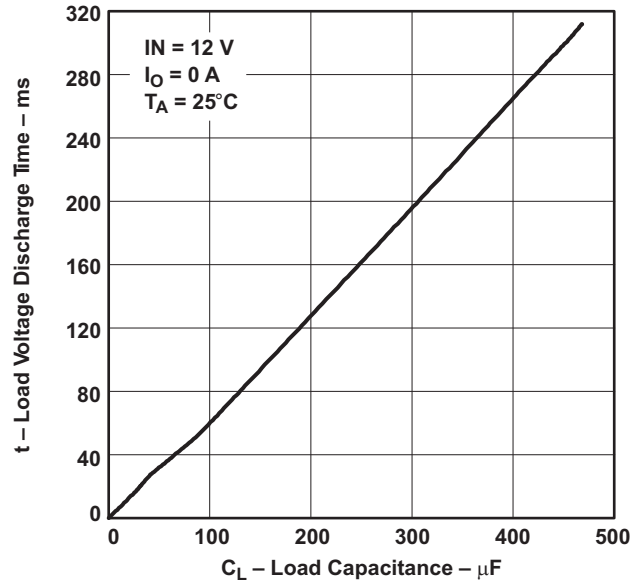

Figure 15.

TYPICAL CHARACTERISTICS (continued)

UVLO START AND STOP THRESHOLDS  
VS  
TEMPERATURE

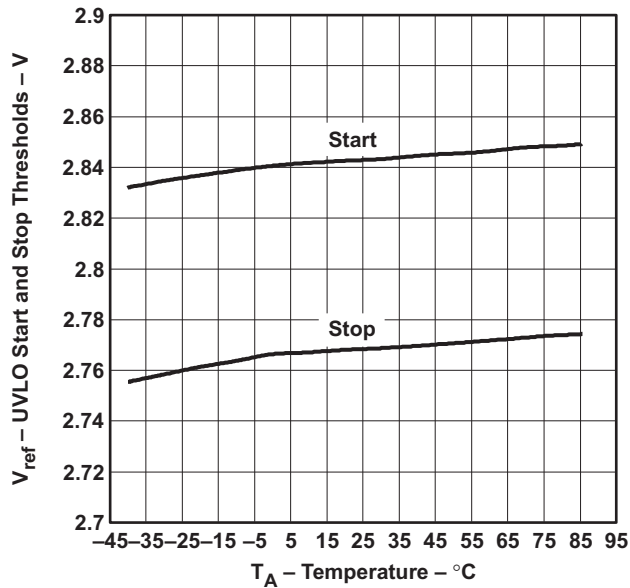

Figure 16.

PWRGD INPUT THRESHOLD  
VS  
TEMPERATURE

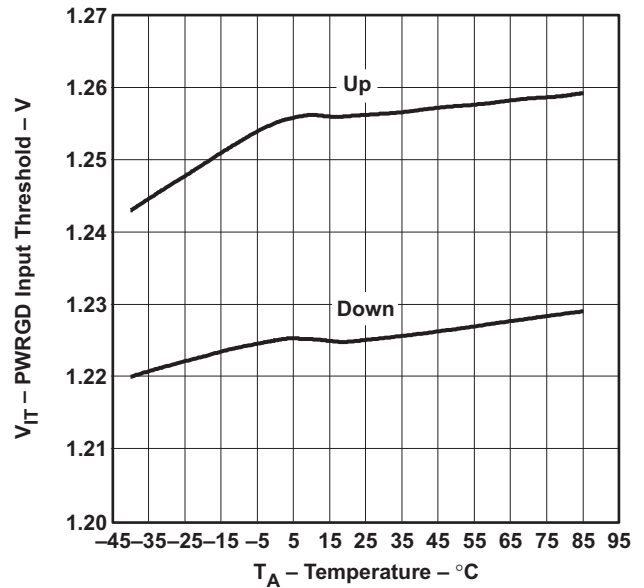

Figure 17.

## APPLICATION INFORMATION

This diagram shows a typical dual hot-swap application. The pullup resistors at PWRGD and  $\overline{\text{FAULT}}$  should be relatively large (e.g. 100 k $\Omega$ ) to reduce power loss unless they are required to drive a large load.

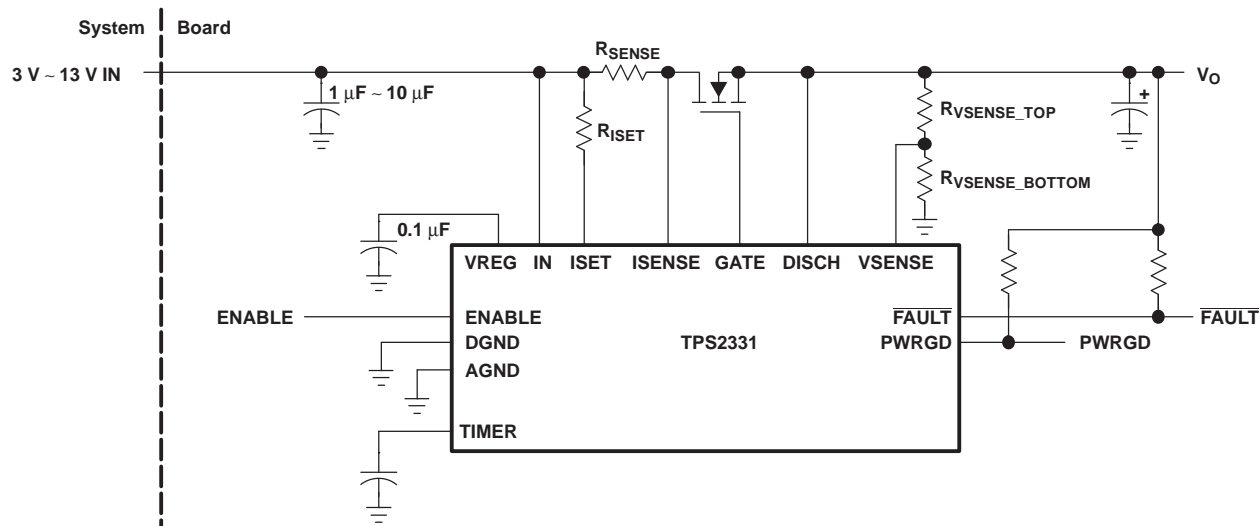

Figure 18. Typical Hot-Swap Application

### INPUT CAPACITOR

A 0.1- $\mu\text{F}$  ceramic capacitor in parallel with a 1- $\mu\text{F}$  ceramic capacitor should be placed on the input power terminals near the connector on the hot-plug board to help stabilize the voltage rails on the cards. There is no need to mount the TPS2330/31 near the connector or these input capacitors. For applications with more severe power environments, a 2.2- $\mu\text{F}$  or higher ceramic capacitor is recommended near the input terminals of the hot-plug board. A bypass capacitor for IN should be placed close to the device.

### OUTPUT CAPACITOR

A 0.1- $\mu\text{F}$  ceramic capacitor is recommended per load on the TPS2330/31; these capacitors should be placed close to the external FETs and to TPS2330/31. A larger bulk capacitor on the load is also recommended. The value of the bulk capacitor should be selected based on the power requirements and the transients generated by the application.

### EXTERNAL FET

To deliver power from the input sources to the loads, the controller needs an external N-channel MOSFET. A few widely used MOSFETs are shown in [Table 3](#). But many other MOSFETs on the market can also be used with the TPS23xx in hot-swap systems.

**Table 3. Some Available N-Channel MOSFETs**

CURRENT RANGE (A)	PART NUMBER	DESCRIPTION	MANUFACTURER
0 to 2	IRF7601	N-channel, $r_{DS(on)} = 0.035 \Omega$ , 4.6 A, Micro-8	International Rectifier
	MTSF3N03HDR2	N-channel, $r_{DS(on)} = 0.040 \Omega$ , 4.6 A, Micro-8	ON Semiconductor
	IRF7101	Dual N-channel, $r_{DS(on)} = 0.1 \Omega$ , 2.3 A, SO-8	International Rectifier
	MMSF5N02HDR2	Dual N-channel, $r_{DS(on)} = 0.04 \Omega$ , 5 A, SO-8	ON Semiconductor
2 to 5	IRF7401	N-channel, $r_{DS(on)} = 0.022 \Omega$ , 7 A, SO-8	International Rectifier
	MMSF5N02HDR2	N-channel, $r_{DS(on)} = 0.025 \Omega$ , 5 A, SO-8	ON Semiconductor
	IRF7313	Dual N-channel, $r_{DS(on)} = 0.029 \Omega$ , 5.2 A, SO-8	International Rectifier
	SI4410	N-channel, $r_{DS(on)} = 0.020 \Omega$ , 8 A, SO-8	Vishay Dale
5 to 10	IRLR3103	N-channel, $r_{DS(on)} = 0.019 \Omega$ , 29 A, d-Pak	International Rectifier
	IRLR2703	N-channel, $r_{DS(on)} = 0.045 \Omega$ , 14 A, d-Pak	International Rectifier

## TIMER

For most applications, a minimum capacitance of 50 pF is recommended to prevent false triggering. This capacitor should be connected between TIMER and ground. The presence of an overcurrent condition on of the TPS2330/31 causes a 50- $\mu$ A current source to begin charging this capacitor. If the overcurrent condition persists until the capacitor has been charged to approximately 0.5 V, the TPS2330/31 latches off the transistor and pulls the FAULT pin low. The timer capacitor can be made as large as desired to provide additional time delay before registering a fault condition. The time delay is approximately:

$$dt(\text{sec}) = C_{(\text{TIMER})}(\text{F}) \times 10,000(\Omega)$$

## OUTPUT-VOLTAGE SLEW-RATE CONTROL

When enabled, the TPS2330/TPS2331 controllers supply the gate of an external MOSFET transistor with a current of approximately 15  $\mu$ A. The slew rate of the MOSFET source voltage is thus limited by the gate-to-drain capacitance  $C_{gd}$  of the external MOSFET capacitor to a value approximating:

$$\frac{dV_s}{dt} = \frac{15 \mu\text{A}}{C_{gd}} \quad (1)$$

If a slower slew rate is desired, an additional capacitance can be connected between the gate of the external MOSFET and ground.

## VREG CAPACITOR

The internal voltage regulator connected to VREG requires an external capacitor to ensure stability. A 0.1- $\mu$ F or 0.22- $\mu$ F ceramic capacitor is recommended.

## GATE DRIVE CIRCUITRY

The TPS2330/TPS2331 includes four separate features associated with each gate-drive terminal:

- A charging current of approximately 15  $\mu$ A is applied to enable the external MOSFET transistor. This current is generated by an internal charge pump that can develop a gate-to-source potential (referenced to DISCH) of 9 V–12 V. DISCH must be connected to the external MOSFET source terminal to ensure proper operation of this circuitry.
- A discharge current of approximately 75  $\mu$ A is applied to disable the external MOSFET transistor. Once the transistor gate voltage has dropped below approximately 1.5 V, this current is disabled and the UVLO discharge driver is enabled instead. This feature allows the part to enter a low-current shutdown mode while ensuring that the gate of the external MOSFET transistor remains at a low voltage.
- During a UVLO condition, the gate of the MOSFET transistor is pulled down by an internal PMOS transistor. This transistor continues to operate even if the voltage at IN is 0 V. This circuitry also helps hold the external MOSFET transistor off when power is suddenly applied to the system.
- During an overcurrent fault condition, the external MOSFET transistor that exhibited an overcurrent condition is rapidly turned off by an internal pulldown circuit capable of pulling in excess of 400 mA (at 4 V) from the

pin. Once the gate has been pulled below approximately 1.5 V, this driver is disengaged and the UVLO driver is enabled instead.

### SETTING THE CURRENT-LIMIT CIRCUIT-BREAKER THRESHOLD

The current sensing resistor  $R_{ISENSE}$  and the current limit setting resistor  $R_{ISET}$  determine the current limit of the channel, and can be calculated by the following equation:

$$I_{LMT} = \frac{R_{ISET} \times 50 \times 10^{-6}}{R_{ISENSE}} \quad (2)$$

Typically  $R_{ISENSE}$  is usually very small (0.001  $\Omega$  to 0.1  $\Omega$ ). If the trace and solder-junction resistances between the junction of  $R_{ISENSE}$  and ISENSE and the junction of  $R_{ISENSE}$  and  $R_{ISET}$  are greater than 10% of the  $R_{ISENSE}$  value, then these resistance values should be added to the  $R_{ISENSE}$  value used in the foregoing calculation.

Table 4 shows some of the current-sense resistors available in the market.

**Table 4. Some Current-Sense Resistors**

CURRENT RANGE (A)	PART NUMBER	DESCRIPTION	MANUFACTURER
0 to 1	WSL-1206, 0.05 1%	0.05 $\Omega$ , 0.25 W, 1% resistor	Vishay Dale
1 to 2	WSL-1206, 0.025 1%	0.025 $\Omega$ , 0.25 W, 1% resistor	
2 to 4	WSL-1206, 0.015 1%	0.015 $\Omega$ , 0.25 W, 1% resistor	
4 to 6	WSL-2010, 0.010 1%	0.010 $\Omega$ , 0.5 W, 1% resistor	
6 to 8	WSL-2010, 0.007 1%	0.007 $\Omega$ , 0.5 W, 1% resistor	
8 to 10	WSR-2, 0.005 1%	0.005 $\Omega$ , 0.5 W, 1% resistor	

### SETTING THE POWER-GOOD THRESHOLD VOLTAGE

The two feedback resistors  $R_{VSENSE\_TOP}$  and  $R_{VSENSE\_BOT}$  connected between  $V_O$  and ground form a resistor divider, setting the voltage at the VSENSE pins. VSENSE voltage equals:

$$V_{(VSENSE)} = V_O \times R_{VSENSE\_BOT} / (R_{VSENSE\_TOP} + R_{VSENSE\_BOT})$$

This voltage is compared to an internal voltage reference (1.225 V  $\pm$ 2%) to determine whether the output voltage level is within a specified tolerance. For example, given a nominal output voltage at  $V_O$ , and defining  $V_{O\_min}$  as the minimum required output voltage, then the feedback resistors are defined by:

$$R_{VSENSE\_TOP} = \frac{V_{O\_min} - 1.225}{1.225} \times R_{VSENSE\_BOT} \quad (3)$$

Start the process by selecting a large standard resistor value for  $R_{VSENSE\_BOT}$  to reduce power loss. Then  $R_{VSENSE\_TOP}$  can be calculated by inserting all of the known values into the preceding equation. When  $V_O$  is lower than  $V_{O\_min}$ , PWRGD is low as long as the controller is enabled.

### UNDERVOLTAGE LOCKOUT (UVLO)

The TPS2330/TPS2331 includes an undervoltage lockout (UVLO) feature that monitors the voltage present on the VREG pin. This feature disables the external MOSFET if the voltage on VREG drops below 2.78 V (nominal) and re-enables normal operation when it rises above 2.85 V (nominal). Because VREG is fed from IN through a low-dropout voltage regulator, the voltage on VREG tracks the voltage on IN within 50 mV. While the undervoltage lockout is engaged, GATE is held low by an internal PMOS pulldown transistor, ensuring that the external MOSFET transistor remain off at the times, even if the power supply has fallen to 0 V.

### POWER-UP CONTROL

The TPS2330/TPS2331 includes a 500- $\mu$ s (nominal) start-up delay that ensures that internal circuitry has sufficient time to start before the device begins turning on the external MOSFETs. This delay is triggered only on the rapid application of power to the circuit. If the power supply ramps up slowly, the undervoltage lockout circuitry provides adequate protection against undervoltage operation.

### THREE-CHANNEL HOT-SWAP APPLICATION

Some applications require hot-swap control of up to three voltage rails, but may not explicitly require the sensing of the status of the output power on all three of the voltage rails. One such application is a device bay, where dV/dt control of 3.3 V, 5 V, and 12 V is required. By using TPS2330/TPS2331 to drive all three power rails, as is shown in Figure 19, TPS2330/31 can deliver three different voltages to three loads while monitoring the status of one of the loads.

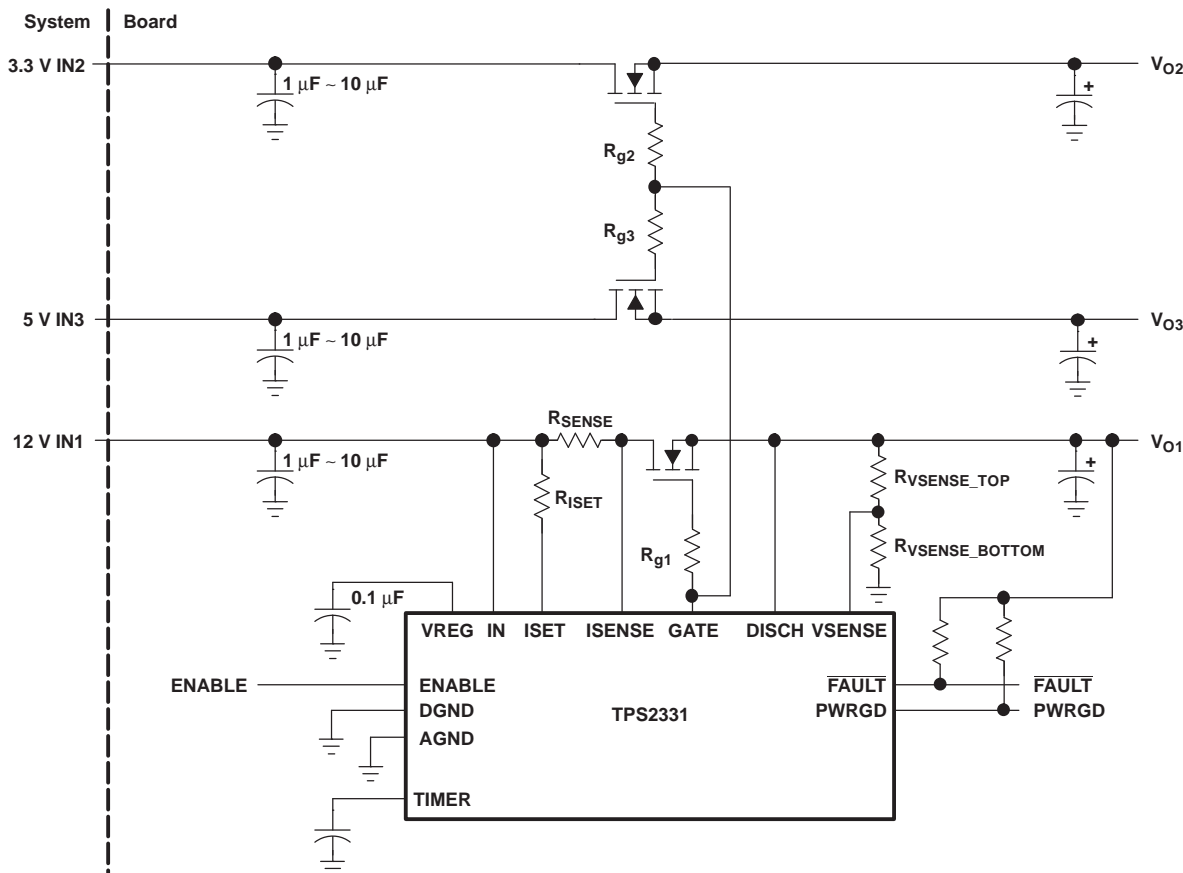

Figure 19. Three-Channel Application

Figure 20 shows ramp-up waveforms of the three output voltages.

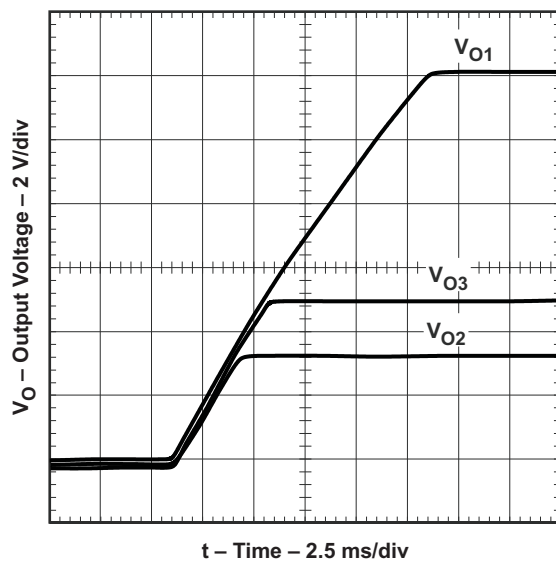

Figure 20.

## REVISION HISTORY

Note: Revision history for previous versions is not available. Page numbers of previous versions may differ.

<b>Changes from Revision F (November 2006) to Revision G</b>	<b>Page</b>
• Added text to ISENSE, ISET pin description paragraph for clarification. ....	<b>3</b>
• Added additional $V_I$ specs to ROC table for clarification .....	<b>4</b>
• Added minus sign to 40°C MIN $T_J$ temperature .....	<b>4</b>

**PACKAGING INFORMATION**

Orderable Device	Status (1)	Package Type	Package Drawing	Pins	Package Qty	Eco Plan (2)	Lead/Ball Finish (6)	MSL Peak Temp (3)	Op Temp (°C)	Device Marking (4/5)	Samples
TPS2330ID	ACTIVE	SOIC	D	14	50	Green (RoHS & no Sb/Br)	CU NIPDAU	Level-1-260C-UNLIM	-40 to 85	TPS2330I	<a href="#">Samples</a>
TPS2330IDR	ACTIVE	SOIC	D	14	2500	Green (RoHS & no Sb/Br)	CU NIPDAU	Level-1-260C-UNLIM	-40 to 85	TPS2330I	<a href="#">Samples</a>
TPS2330IDRG4	ACTIVE	SOIC	D	14	2500	Green (RoHS & no Sb/Br)	CU NIPDAU	Level-1-260C-UNLIM	-40 to 85	TPS2330I	<a href="#">Samples</a>
TPS2330IPW	ACTIVE	TSSOP	PW	14	90	Green (RoHS & no Sb/Br)	CU NIPDAU	Level-1-260C-UNLIM	-40 to 85	PD2330I	<a href="#">Samples</a>
TPS2330IPWG4	ACTIVE	TSSOP	PW	14	90	Green (RoHS & no Sb/Br)	CU NIPDAU	Level-1-260C-UNLIM	-40 to 85	PD2330I	<a href="#">Samples</a>
TPS2330IPWR	ACTIVE	TSSOP	PW	14	2000	Green (RoHS & no Sb/Br)	CU NIPDAU	Level-1-260C-UNLIM	-40 to 85	PD2330I	<a href="#">Samples</a>
TPS2330IPWRG4	ACTIVE	TSSOP	PW	14	2000	Green (RoHS & no Sb/Br)	CU NIPDAU	Level-1-260C-UNLIM	-40 to 85	PD2330I	<a href="#">Samples</a>
TPS2331ID	ACTIVE	SOIC	D	14	50	Green (RoHS & no Sb/Br)	CU NIPDAU	Level-1-260C-UNLIM	-40 to 85	TPS2331I	<a href="#">Samples</a>
TPS2331IDR	ACTIVE	SOIC	D	14	2500	Green (RoHS & no Sb/Br)	CU NIPDAU	Level-1-260C-UNLIM	-40 to 85	TPS2331I	<a href="#">Samples</a>
TPS2331IDRG4	ACTIVE	SOIC	D	14	2500	Green (RoHS & no Sb/Br)	CU NIPDAU	Level-1-260C-UNLIM	-40 to 85	TPS2331I	<a href="#">Samples</a>
TPS2331IPW	ACTIVE	TSSOP	PW	14	90	Green (RoHS & no Sb/Br)	CU NIPDAU	Level-1-260C-UNLIM	-40 to 85	PD2331I	<a href="#">Samples</a>
TPS2331IPWR	ACTIVE	TSSOP	PW	14	2000	Green (RoHS & no Sb/Br)	CU NIPDAU	Level-1-260C-UNLIM	-40 to 85	PD2331I	<a href="#">Samples</a>

(1) The marketing status values are defined as follows:

**ACTIVE:** Product device recommended for new designs.

**LIFEBUY:** TI has announced that the device will be discontinued, and a lifetime-buy period is in effect.

**NRND:** Not recommended for new designs. Device is in production to support existing customers, but TI does not recommend using this part in a new design.

**PREVIEW:** Device has been announced but is not in production. Samples may or may not be available.

**OBSELETE:** TI has discontinued the production of the device.

(2) **RoHS:** TI defines "RoHS" to mean semiconductor products that are compliant with the current EU RoHS requirements for all 10 RoHS substances, including the requirement that RoHS substance do not exceed 0.1% by weight in homogeneous materials. Where designed to be soldered at high temperatures, "RoHS" products are suitable for use in specified lead-free processes. TI may reference these types of products as "Pb-Free".

**RoHS Exempt:** TI defines "RoHS Exempt" to mean products that contain lead but are compliant with EU RoHS pursuant to a specific EU RoHS exemption.

**Green:** TI defines "Green" to mean the content of Chlorine (Cl) and Bromine (Br) based flame retardants meet JS709B low halogen requirements of  $\leq 1000$ ppm threshold. Antimony trioxide based flame retardants must also meet the  $\leq 1000$ ppm threshold requirement.

(3) MSL, Peak Temp. - The Moisture Sensitivity Level rating according to the JEDEC industry standard classifications, and peak solder temperature.

(4) There may be additional marking, which relates to the logo, the lot trace code information, or the environmental category on the device.

(5) Multiple Device Markings will be inside parentheses. Only one Device Marking contained in parentheses and separated by a "~" will appear on a device. If a line is indented then it is a continuation of the previous line and the two combined represent the entire Device Marking for that device.

(6) Lead/Ball Finish - Orderable Devices may have multiple material finish options. Finish options are separated by a vertical ruled line. Lead/Ball Finish values may wrap to two lines if the finish value exceeds the maximum column width.

**Important Information and Disclaimer:** The information provided on this page represents TI's knowledge and belief as of the date that it is provided. TI bases its knowledge and belief on information provided by third parties, and makes no representation or warranty as to the accuracy of such information. Efforts are underway to better integrate information from third parties. TI has taken and continues to take reasonable steps to provide representative and accurate information but may not have conducted destructive testing or chemical analysis on incoming materials and chemicals. TI and TI suppliers consider certain information to be proprietary, and thus CAS numbers and other limited information may not be available for release.

In no event shall TI's liability arising out of such information exceed the total purchase price of the TI part(s) at issue in this document sold by TI to Customer on an annual basis.

**TAPE AND REEL INFORMATION**

**QUADRANT ASSIGNMENTS FOR PIN 1 ORIENTATION IN TAPE**

\*All dimensions are nominal

Device	Package Type	Package Drawing	Pins	SPQ	Reel Diameter (mm)	Reel Width W1 (mm)	A0 (mm)	B0 (mm)	K0 (mm)	P1 (mm)	W (mm)	Pin1 Quadrant
TPS2330IDR	SOIC	D	14	2500	330.0	16.4	6.5	9.0	2.1	8.0	16.0	Q1
TPS2330IPWR	TSSOP	PW	14	2000	330.0	12.4	6.9	5.6	1.6	8.0	12.0	Q1
TPS2331IDR	SOIC	D	14	2500	330.0	16.4	6.5	9.0	2.1	8.0	16.0	Q1
TPS2331IPWR	TSSOP	PW	14	2000	330.0	12.4	6.9	5.6	1.6	8.0	12.0	Q1

**TAPE AND REEL BOX DIMENSIONS**

\*All dimensions are nominal

Device	Package Type	Package Drawing	Pins	SPQ	Length (mm)	Width (mm)	Height (mm)
TPS2330IDR	SOIC	D	14	2500	350.0	350.0	43.0
TPS2330IPWR	TSSOP	PW	14	2000	367.0	367.0	35.0
TPS2331IDR	SOIC	D	14	2500	350.0	350.0	43.0
TPS2331IPWR	TSSOP	PW	14	2000	367.0	367.0	35.0



D (R-PDSO-G14)

PLASTIC SMALL OUTLINE



4211283-3/E 08/12

- NOTES:
- All linear dimensions are in millimeters.
  - This drawing is subject to change without notice.
  - Publication IPC-7351 is recommended for alternate designs.
  - Laser cutting apertures with trapezoidal walls and also rounding corners will offer better paste release. Customers should contact their board assembly site for stencil design recommendations. Refer to IPC-7525 for other stencil recommendations.
  - Customers should contact their board fabrication site for solder mask tolerances between and around signal pads.



## IMPORTANT NOTICE AND DISCLAIMER

TI PROVIDES TECHNICAL AND RELIABILITY DATA (INCLUDING DATASHEETS), DESIGN RESOURCES (INCLUDING REFERENCE DESIGNS), APPLICATION OR OTHER DESIGN ADVICE, WEB TOOLS, SAFETY INFORMATION, AND OTHER RESOURCES "AS IS" AND WITH ALL FAULTS, AND DISCLAIMS ALL WARRANTIES, EXPRESS AND IMPLIED, INCLUDING WITHOUT LIMITATION ANY IMPLIED WARRANTIES OF MERCHANTABILITY, FITNESS FOR A PARTICULAR PURPOSE OR NON-INFRINGEMENT OF THIRD PARTY INTELLECTUAL PROPERTY RIGHTS.

These resources are intended for skilled developers designing with TI products. You are solely responsible for (1) selecting the appropriate TI products for your application, (2) designing, validating and testing your application, and (3) ensuring your application meets applicable standards, and any other safety, security, or other requirements. These resources are subject to change without notice. TI grants you permission to use these resources only for development of an application that uses the TI products described in the resource. Other reproduction and display of these resources is prohibited. No license is granted to any other TI intellectual property right or to any third party intellectual property right. TI disclaims responsibility for, and you will fully indemnify TI and its representatives against, any claims, damages, costs, losses, and liabilities arising out of your use of these resources.

TI's products are provided subject to TI's Terms of Sale ([www.ti.com/legal/termsofsale.html](http://www.ti.com/legal/termsofsale.html)) or other applicable terms available either on [ti.com](http://ti.com) or provided in conjunction with such TI products. TI's provision of these resources does not expand or otherwise alter TI's applicable warranties or warranty disclaimers for TI products.

Mailing Address: Texas Instruments, Post Office Box 655303, Dallas, Texas 75265  
Copyright © 2019, Texas Instruments Incorporated

## Looking for pricing, stock, or lifecycle information?

Click below to explore more details on WIN SOURCE:

 [View TPS2330IPW on WIN SOURCE](#)

 [Texas Instruments](#) Information

## Optimize Your Supply Chain with WIN SOURCE Solutions

-  Global Sourcing Solution
-  Obsolete Management
-  Cost Control Management
-  Shortage Management
-  Alternative Solution
-  Excess Inventory Management