



**THE DATASHEET OF  
TPS22922YZPR**



## TPS2292x 3.6-V, 2-A, 14-mΩ ON-Resistance Load Switch With Controlled Turnon

### 1 Features

- Integrated P-Channel Load Switch
- Input Voltage: 0.9 V to 3.6 V
- ON-Resistance (Typical Values)
  - $r_{ON} = 14 \text{ m}\Omega$  at  $V_{IN} = 3.6 \text{ V}$
  - $r_{ON} = 20 \text{ m}\Omega$  at  $V_{IN} = 2.5 \text{ V}$
  - $r_{ON} = 33 \text{ m}\Omega$  at  $V_{IN} = 1.8 \text{ V}$
  - $r_{ON} = 67 \text{ m}\Omega$  at  $V_{IN} = 1.2 \text{ V}$
  - $r_{ON} = 116 \text{ m}\Omega$  at  $V_{IN} = 1.0 \text{ V}$
- 2-A Maximum Continuous Switch Current
- Quiescent Current:
  - Typical 78 nA at 1.8 V
- Shutdown Current:
  - Typical 35 nA at 1.8 V
- Low Threshold Control Input Enable the use of 1.2 V, 1.8 V, 2.5 V, or 3.3 V Logic
- Controlled Slew Rate to Avoid Inrush Currents
  - $t_R = 30 \text{ }\mu\text{s}$  at  $V_{IN} = 1.8 \text{ V}$  (TPS22921/2)
  - $t_R = 200 \text{ }\mu\text{s}$  at  $V_{IN} = 1.8 \text{ V}$  (TPS22922B)
- Quick Output Discharge (TPS22922/2B)
- ESD Performance Tested Per JESD 22
  - 3000-V Human Body Model (A114-B, Class II)
  - 1000-V Charged-Device Model (C101)
- Six Terminal Wafer-Chip-Scale DSBGA Package (nominal dimensions shown - see [Mechanical, Packaging, and Orderable Information](#) for details)
  - 0.9-mm x 1.4-mm, 0.5-mm Pitch, 0.5 mm Height (YZP)
  - 0.9-mm x 1.4-mm, 0.5-mm Pitch, 0.625 mm Height (YZT)
  - 0.8-mm x 1.2-mm, 0.4-mm Pitch, 0.5-mm Height (YFP)

### 2 Applications

- PDAs
- Cell Phones
- GPS Devices
- MP3 Players
- Peripheral Ports
- Portable Media Players
- RF Modules

### 3 Description

TPS22921, TPS22922, and TPS22922B are small, low  $r_{ON}$  load switches with controlled turnon. The TPS22921/2/2B contains a P-channel MOSFET that can operate over an input voltage range of 0.9 V to 3.6 V. The switch is controlled by an on/off input (ON), which can interface directly with low-voltage control signals. In TPS22922 and in TPS22922B, a 65- $\Omega$  on-chip load resistor is added for output quick discharge when the switch is turned off. The rise time (slew rate) of the device is internally controlled in order to avoid inrush current: TPS22921 and TPS22922 feature a 30- $\mu\text{s}$  rise time, whereas TPS22922B is 200  $\mu\text{s}$ .

TPS22921, TPS22922, and TPS22922B feature low quiescent and shutdown currents and are available in space-saving 6-pin wafer-chip-scale packages DSBGA (WCSP: YZP and YZT with 0.5-mm pitch and YFP with 0.4-mm pitch) which make them ideal for portable electronics. The devices are characterized for operation over the free-air temperature range of  $-40^\circ\text{C}$  to  $85^\circ\text{C}$ .

#### Device Information<sup>(1)</sup>

PART NUMBER	PACKAGE	BODY SIZE (NOM)
TPS22921 <sup>(1)</sup>	YZT	0.9 mm x 1.4 mm
	YZP	
	YFP	0.8 mm x 1.2 mm
TPS22922 TPS22922B	YZP	0.9 mm x 1.4 mm
	YFP	0.8 mm x 1.2 mm

(1) For all available packages, see the orderable addendum at the end of the data sheet.

### 4 Typical Application

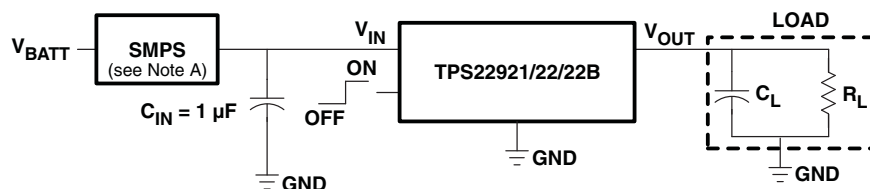

A. Switched-mode power supply



## Table of Contents

<b>1 Features</b> .....	<b>1</b>	8.14 Typical Characteristics .....	<b>10</b>
<b>2 Applications</b> .....	<b>1</b>	<b>9 Parameter Measurement Information</b> .....	<b>19</b>
<b>3 Description</b> .....	<b>1</b>	<b>10 Detailed Description</b> .....	<b>20</b>
<b>4 Typical Application</b> .....	<b>1</b>	10.1 Overview .....	<b>20</b>
<b>5 Revision History</b> .....	<b>2</b>	10.2 Functional Block Diagram .....	<b>20</b>
<b>6 Device Comparison Table</b> .....	<b>3</b>	10.3 Feature Description .....	<b>20</b>
<b>7 Pin Configuration and Functions</b> .....	<b>3</b>	10.4 Device Functional Modes .....	<b>20</b>
<b>8 Specifications</b> .....	<b>4</b>	<b>11 Application and Implementation</b> .....	<b>21</b>
8.1 Absolute Maximum Ratings .....	<b>4</b>	11.1 Application Information .....	<b>21</b>
8.2 ESD Ratings .....	<b>4</b>	11.2 Typical Application .....	<b>21</b>
8.3 Recommended Operating Conditions .....	<b>4</b>	<b>12 Power Supply Recommendations</b> .....	<b>24</b>
8.4 Thermal Information .....	<b>4</b>	<b>13 Layout</b> .....	<b>24</b>
8.5 Electrical Characteristics .....	<b>5</b>	13.1 Layout Guidelines .....	<b>24</b>
8.6 Switching Characteristics: $V_{IN} = 0.9\text{ V}$ .....	<b>6</b>	13.2 Layout Example .....	<b>24</b>
8.7 Switching Characteristics: $V_{IN} = 1\text{ V}$ .....	<b>6</b>	<b>14 Device and Documentation Support</b> .....	<b>25</b>
8.8 Switching Characteristics: $V_{IN} = 1.1\text{ V}$ .....	<b>7</b>	14.1 Related Links .....	<b>25</b>
8.9 Switching Characteristics: $V_{IN} = 1.2\text{ V}$ .....	<b>7</b>	14.2 Trademarks .....	<b>25</b>
8.10 Switching Characteristics: $V_{IN} = 1.8\text{ V}$ .....	<b>8</b>	14.3 Electrostatic Discharge Caution .....	<b>25</b>
8.11 Switching Characteristics: $V_{IN} = 2.5\text{ V}$ .....	<b>8</b>	14.4 Glossary .....	<b>25</b>
8.12 Switching Characteristics: $V_{IN} = 3\text{ V}$ .....	<b>9</b>	<b>15 Mechanical, Packaging, and Orderable Information</b> .....	<b>25</b>
8.13 Switching Characteristics: $V_{IN} = 3.6\text{ V}$ .....	<b>9</b>		

## 5 Revision History

NOTE: Page numbers for previous revisions may differ from page numbers in the current version.

Changes from Revision B (May 2012) to Revision C	Page
<ul style="list-style-type: none"> <li>Added <i>Pin Configuration and Functions</i> section, <i>ESD Rating</i> table, <i>Feature Description</i> section, <i>Device Functional Modes</i>, <i>Application and Implementation</i> section, <i>Power Supply Recommendations</i> section, <i>Layout</i> section, <i>Device and Documentation Support</i> section, and <i>Mechanical, Packaging, and Orderable Information</i> section .....</li> </ul>	<b>1</b>

Changes from Revision A (December 2008) to Revision B	Page
<ul style="list-style-type: none"> <li>Changed Feature From: Ultra-Low Quiescent Current: 78 nA at 1.8 V To: Ultra-Low Quiescent Current: Typical 78 nA at 1.8 V .....</li> <li>Changed Feature From: Typical 78 nA at 1.8 V To: Ultra-Low Shutdown Current: Typical 35 nA at 1.8 V .....</li> <li>Changed Feature From: Six Terminal Wafer-Chip-Scale Package To: Six Terminal Wafer-Chip-Scale Package (nominal dimensions shown - see addendum for details) .....</li> <li>Changed Feature From: 0.5-mm Height To: 0.5-mm Height (YFP) .....</li> <li>Changed TPS22921 QUICK OUTPUT DISCHARGE From: - To: No .....</li> <li>Changed the format of the ELECTRICAL CHARACTERISTICS Test Conditions From: <math>V_{IN} = 1\text{-V}</math> to <math>V_{IN} = 1\text{ V}</math> .....</li> <li>Deleted Note 1 - RL_CHIP = 120 <math>\Omega</math> from all SWITCHING CHARACTERISTICS tables .....</li> <li>Changed <a href="#">Figure 50</a> title From: <math>t_{OFF}</math> Response To: <math>t_{ON}</math> Response .....</li> </ul>	<b>1</b> <b>1</b> <b>1</b> <b>1</b> <b>3</b> <b>5</b> <b>6</b> <b>17</b>

Changes from Original (November 2008) to Revision A	Page
<ul style="list-style-type: none"> <li>Added Note A to the TYPICAL APPLICATION circuit .....</li> </ul>	<b>1</b>

## 6 Device Comparison Table

	R <sub>ON</sub> AT 1.8 V (TYP)	RISE TIME (TYP at 1.8 V)	QUICK OUTPUT DISCHARGE <sup>(1)</sup>	MAX OUTPUT CURRENT	ENABLE
TPS22921	33 mΩ	30 μs	No	2 A	Active high
TPS22922	33 mΩ	30 μs	Yes	2 A	Active high
TPS22922B	33 mΩ	200 μs	Yes	2 A	Active high

(1) This feature discharges the output of the switch to ground through a 120-Ω resistor, preventing the output from floating.

## 7 Pin Configuration and Functions

### YFP, YZP, AND YZT PACKAGES

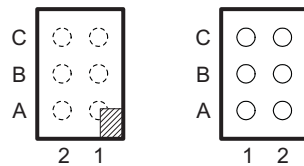

Laser Marking View    Bump View

### Pin Assignments

<b>C</b>	ON	GND
<b>B</b>	V <sub>IN</sub>	V <sub>OUT</sub>
<b>A</b>	V <sub>IN</sub>	V <sub>OUT</sub>
	<b>2</b>	<b>1</b>

### Pin Functions

PIN		I/O	DESCRIPTION
NO.	NAME		
A1	V <sub>OUT</sub>	O	Switch output
A2	V <sub>IN</sub>	I	Switch input. Use a bypass capacitor to ground (ceramic)
B1	V <sub>OUT</sub>	O	Switch output
B2	V <sub>IN</sub>	I	Switch input. Use a bypass capacitor to ground (ceramic)
C1	GND	–	Ground
C2	ON	I	Switch control input, active high. Do not leave floating

## 8 Specifications

### 8.1 Absolute Maximum Ratings<sup>(1)</sup>

		MIN	MAX	UNIT
V <sub>IN</sub>	Input voltage	-0.3	4	V
V <sub>OUT</sub>	Output voltage		V <sub>IN</sub> + 0.3	V
V <sub>ON</sub>	Input voltage	-0.3	4	V
P	Power dissipation at T <sub>A</sub> = 25°C		0.645	W
I <sub>MAX</sub>	Maximum continuous switch current		2	A
T <sub>A</sub>	Operating free-air temperature	-40	85	°C
T <sub>lead</sub>	Maximum lead temperature (10-s soldering time)		300	°C
T <sub>stg</sub>	Storage temperature	-65	150	°C

- (1) Stresses beyond those listed under *Absolute Maximum Ratings* may cause permanent damage to the device. These are stress ratings only, and functional operation of the device at these or any other conditions beyond those indicated under *Recommended Operating Conditions* is not implied. Exposure to absolute-maximum-rated conditions for extended periods may affect device reliability.

### 8.2 ESD Ratings

		VALUE	UNIT
V <sub>(ESD)</sub>	Electrostatic discharge	Human body model (HBM), per ANSI/ESDA/JEDEC JS-001 <sup>(1)</sup>	±3000
		Charged-device model (CDM), per JEDEC specification JESD22-C101 <sup>(2)</sup>	±1000
		Machine model (MM)	±300

- (1) JEDEC document JEP155 states that 500-V HBM allows safe manufacturing with a standard ESD control process.  
 (2) JEDEC document JEP157 states that 250-V CDM allows safe manufacturing with a standard ESD control process.

### 8.3 Recommended Operating Conditions

		MIN	MAX	UNIT
V <sub>IN</sub>	Input voltage range	0.9	3.6	V
V <sub>OUT</sub>	Output voltage range		V <sub>IN</sub>	V
V <sub>IH</sub>	High-level input voltage, ON	0.85	3.6	V
V <sub>IL</sub>	Low-level input voltage, ON		0.4	V
C <sub>IN</sub>	Input capacitor	1 <sup>(1)</sup>		μF

- (1) Refer to [Application Information](#).

### 8.4 Thermal Information

THERMAL METRIC <sup>(1)</sup>	TPS22921, TPS22922, TPS22922B		TPS22921	UNIT	
	YFP	YZP	YZT		
	6 PINS				
R <sub>θJA</sub>	Junction-to-ambient thermal resistance	125.1	131	120.7	°C/W
R <sub>θJC(top)</sub>	Junction-to-case (top) thermal resistance	1.4	1.3	2.1	
R <sub>θJB</sub>	Junction-to-board thermal resistance	26	22.6	26.4	
Ψ <sub>JT</sub>	Junction-to-top characterization parameter	0.3	5.2	3.7	
Ψ <sub>JB</sub>	Junction-to-board characterization parameter	26	22.6	26.4	

- (1) For more information about traditional and new thermal metrics, see the *IC Package Thermal Metrics* application report, [SPRA953](#).

## 8.5 Electrical Characteristics

 $V_{IN} = 0.9\text{ V to }3.6\text{ V}$ ,  $T_A = -40^\circ\text{C to }85^\circ\text{C}$  (unless otherwise noted)

PARAMETER		TEST CONDITIONS		$T_A$	MIN	TYP <sup>(1)</sup>	MAX	UNIT
$I_Q$	Quiescent current	$I_{OUT} = 0\text{ mA}$	$V_{IN} = 1\text{ V}$	Full	30	120		nA
			$V_{IN} = 1.8\text{ V}$	Full	78	235		
			$V_{IN} = 3.6\text{ V}$	Full	200	880		
$I_{IN(OFF)}$	OFF-state supply current	$V_{ON} = \text{GND}$ , $V_{OUT} = \text{Open}$	$V_{IN} = 1\text{ V}$	Full	10	210		nA
			$V_{IN} = 1.8\text{ V}$	Full	35	260		
			$V_{IN} = 3.6\text{ V}$	Full	120	700		
$I_{IN(LEAKAGE)}$	OFF-state switch current	$V_{ON} = \text{GND}$ , $V_{OUT} = 0\text{ V}$	$V_{IN} = 1\text{ V}$	Full	12	140		nA
			$V_{IN} = 1.8\text{ V}$	Full	50	230		
			$V_{IN} = 3.6\text{ V}$	Full	130	610		
$r_{ON}$	ON-state resistance	$I_{OUT} = -200\text{ mA}$	$V_{IN} = 3.6\text{ V}$	25°C	14	45		mΩ
				Full		50		
			$V_{IN} = 2.5\text{ V}$	25°C	20	55		
				Full		60		
			$V_{IN} = 1.8\text{ V}$	25°C	33	65		
				Full		75		
			$V_{IN} = 1.2\text{ V}$	25°C	67	100		
				Full		120		
			$V_{IN} = 1.1\text{ V}$	25°C	82	150		
				Full		160		
			$V_{IN} = 1\text{ V}$	25°C	116	160		
				Full		170		
$r_{PD}$	Output pulldown resistance	$V_{IN} = 3.3\text{ V}$ , $V_{ON} = 0\text{ V}$ , $I_{OUT} = 30\text{ mA}$ (TPS22922 and TPS22922B only)	25°C	65	120		Ω	
$I_{ON}$	ON input leakage current	$V_{ON} = 1.1\text{ V to }3.6\text{ V or GND}$	Full		25		nA	

 (1) Typical values are at the specified  $V_{IN}$  and  $T_A = 25^\circ\text{C}$ .

## 8.6 Switching Characteristics: $V_{IN} = 0.9\text{ V}$

 $V_{IN} = 0.9\text{ V}$ ,  $T_A = 25^\circ\text{C}$  (unless otherwise noted)

PARAMETER	TEST CONDITIONS	TPS22921			TPS22922			TPS22922B			UNIT	
		MIN	TYP	MAX	MIN	TYP	MAX	MIN	TYP	MAX		
$t_{ON}$ Turn-ON time	$R_L = 500\ \Omega$	$C_L = 0.1\ \mu\text{F}$	121			121			638			$\mu\text{s}$
		$C_L = 1\ \mu\text{F}$	160			160			712			
		$C_L = 3\ \mu\text{F}$	188			188			799			
$t_{OFF}$ Turn-OFF time	$R_L = 500\ \Omega$	$C_L = 0.1\ \mu\text{F}$	46			40			40			$\mu\text{s}$
		$C_L = 1\ \mu\text{F}$	308			279			279			
		$C_L = 3\ \mu\text{F}$	975			807			807			
$t_r$ $V_{OUT}$ rise time	$R_L = 500\ \Omega$	$C_L = 0.1\ \mu\text{F}$	60			60			462			$\mu\text{s}$
		$C_L = 1\ \mu\text{F}$	85			85			465			
		$C_L = 3\ \mu\text{F}$	107			107			507			
$t_f$ $V_{OUT}$ fall time	$R_L = 500\ \Omega$	$C_L = 0.1\ \mu\text{F}$	119			51			51			$\mu\text{s}$
		$C_L = 1\ \mu\text{F}$	969			434			434			
		$C_L = 3\ \mu\text{F}$	3174			1264			1264			

## 8.7 Switching Characteristics: $V_{IN} = 1\text{ V}$

 $V_{IN} = 1\text{ V}$ ,  $T_A = 25^\circ\text{C}$  (unless otherwise noted)

PARAMETER	TEST CONDITIONS	TPS22921			TPS22922			TPS22922B			UNIT	
		MIN	TYP	MAX	MIN	TYP	MAX	MIN	TYP	MAX		
$t_{ON}$ Turn-ON time	$R_L = 500\ \Omega$	$C_L = 0.1\ \mu\text{F}$	105			105			549			$\mu\text{s}$
		$C_L = 1\ \mu\text{F}$	136			136			613			
		$C_L = 3\ \mu\text{F}$	157			157			683			
$t_{OFF}$ Turn-OFF time	$R_L = 500\ \Omega$	$C_L = 0.1\ \mu\text{F}$	46			28			28			$\mu\text{s}$
		$C_L = 1\ \mu\text{F}$	309			186			186			
		$C_L = 3\ \mu\text{F}$	983			511			511			
$t_r$ $V_{OUT}$ rise time	$R_L = 500\ \Omega$	$C_L = 0.1\ \mu\text{F}$	51			51			386			$\mu\text{s}$
		$C_L = 1\ \mu\text{F}$	78			78			388			
		$C_L = 3\ \mu\text{F}$	88			88			419			
$t_f$ $V_{OUT}$ fall time	$R_L = 500\ \Omega$	$C_L = 0.1\ \mu\text{F}$	121			34			34			$\mu\text{s}$
		$C_L = 1\ \mu\text{F}$	986			306			306			
		$C_L = 3\ \mu\text{F}$	3300			908			908			

### 8.8 Switching Characteristics: $V_{IN} = 1.1\text{ V}$

 $V_{IN} = 1.1\text{ V}$ ,  $T_A = 25^\circ\text{C}$  (unless otherwise noted)

PARAMETER	TEST CONDITIONS		TPS22921			TPS22922			TPS22922B			UNIT
			MIN	TYP	MAX	MIN	TYP	MAX	MIN	TYP	MAX	
$t_{ON}$ Turn-ON time	$R_L = 500\ \Omega$	$C_L = 0.1\ \mu\text{F}$	91			93			484			$\mu\text{s}$
		$C_L = 1\ \mu\text{F}$	118			118			540			
		$C_L = 3\ \mu\text{F}$	137			137			599			
$t_{OFF}$ Turn-OFF time	$R_L = 500\ \Omega$	$C_L = 0.1\ \mu\text{F}$	44			21			21			$\mu\text{s}$
		$C_L = 1\ \mu\text{F}$	311			144			144			
		$C_L = 3\ \mu\text{F}$	99			383			383			
$t_r$ $V_{OUT}$ rise time	$R_L = 500\ \Omega$	$C_L = 0.1\ \mu\text{F}$	46			46			335			$\mu\text{s}$
		$C_L = 1\ \mu\text{F}$	60			60			336			
		$C_L = 3\ \mu\text{F}$	76			76			363			
$t_f$ $V_{OUT}$ fall time	$R_L = 500\ \Omega$	$C_L = 0.1\ \mu\text{F}$	122			29			29			$\mu\text{s}$
		$C_L = 1\ \mu\text{F}$	1000			224			224			
		$C_L = 3\ \mu\text{F}$	3300			732			732			

### 8.9 Switching Characteristics: $V_{IN} = 1.2\text{ V}$

 $V_{IN} = 1.2\text{ V}$ ,  $T_A = 25^\circ\text{C}$  (unless otherwise noted)

PARAMETER	TEST CONDITIONS		TPS22921			TPS22922			TPS22922B			UNIT
			MIN	TYP	MAX	MIN	TYP	MAX	MIN	TYP	MAX	
$t_{ON}$ Turn-ON time	$R_L = 500\ \Omega$	$C_L = 0.1\ \mu\text{F}$	83			83			435			$\mu\text{s}$
		$C_L = 1\ \mu\text{F}$	103			103			485			
		$C_L = 3\ \mu\text{F}$	122			122			536			
$t_{OFF}$ Turn-OFF time	$R_L = 500\ \Omega$	$C_L = 0.1\ \mu\text{F}$	44			17			17			$\mu\text{s}$
		$C_L = 1\ \mu\text{F}$	312			117			117			
		$C_L = 3\ \mu\text{F}$	1000			319			319			
$t_r$ $V_{OUT}$ rise time	$R_L = 500\ \Omega$	$C_L = 0.1\ \mu\text{F}$	41			41			301			$\mu\text{s}$
		$C_L = 1\ \mu\text{F}$	54			54			302			
		$C_L = 3\ \mu\text{F}$	67			67			325			
$t_f$ $V_{OUT}$ fall time	$R_L = 500\ \Omega$	$C_L = 0.1\ \mu\text{F}$	123			25			25			$\mu\text{s}$
		$C_L = 1\ \mu\text{F}$	1000			214			214			
		$C_L = 3\ \mu\text{F}$	3400			632			632			

### 8.10 Switching Characteristics: $V_{IN} = 1.8\text{ V}$

 $V_{IN} = 1.8\text{ V}$ ,  $T_A = 25^\circ\text{C}$  (unless otherwise noted)

PARAMETER	TEST CONDITIONS	TPS22921			TPS22922			TPS22922B			UNIT	
		MIN	TYP	MAX	MIN	TYP	MAX	MIN	TYP	MAX		
$t_{ON}$ Turn-ON time	$R_L = 500\ \Omega$	$C_L = 0.1\ \mu\text{F}$	54			54			282			$\mu\text{s}$
		$C_L = 1\ \mu\text{F}$	67			67			314			
		$C_L = 3\ \mu\text{F}$	78			78			344			
$t_{OFF}$ Turn-OFF time	$R_L = 500\ \Omega$	$C_L = 0.1\ \mu\text{F}$	41			10			10			$\mu\text{s}$
		$C_L = 1\ \mu\text{F}$	312			67			67			
		$C_L = 3\ \mu\text{F}$	1000			181			181			
$t_r$ $V_{OUT}$ rise time	$R_L = 500\ \Omega$	$C_L = 0.1\ \mu\text{F}$	30			30			200			$\mu\text{s}$
		$C_L = 1\ \mu\text{F}$	37			37			202			
		$C_L = 3\ \mu\text{F}$	47			47			219			
$t_f$ $V_{OUT}$ fall time	$R_L = 500\ \Omega$	$C_L = 0.1\ \mu\text{F}$	121			17			17			$\mu\text{s}$
		$C_L = 1\ \mu\text{F}$	1000			158			158			
		$C_L = 3\ \mu\text{F}$	3450			461			461			

### 8.11 Switching Characteristics: $V_{IN} = 2.5\text{ V}$

 $V_{IN} = 2.5\text{ V}$ ,  $T_A = 25^\circ\text{C}$  (unless otherwise noted)

PARAMETER	TEST CONDITIONS	TPS22921			TPS22922			TPS22922B			UNIT	
		MIN	TYP	MAX	MIN	TYP	MAX	MIN	TYP	MAX		
$t_{ON}$ Turn-ON time	$R_L = 500\ \Omega$	$C_L = 0.1\ \mu\text{F}$	40			40			211			$\mu\text{s}$
		$C_L = 1\ \mu\text{F}$	50			50			233			
		$C_L = 3\ \mu\text{F}$	59			59			256			
$t_{OFF}$ Turn-OFF time	$R_L = 500\ \Omega$	$C_L = 0.1\ \mu\text{F}$	41			10			10			$\mu\text{s}$
		$C_L = 1\ \mu\text{F}$	316			56			56			
		$C_L = 3\ \mu\text{F}$	1000			153			153			
$t_r$ $V_{OUT}$ rise time	$R_L = 500\ \Omega$	$C_L = 0.1\ \mu\text{F}$	23			23			164			$\mu\text{s}$
		$C_L = 1\ \mu\text{F}$	29			29			165			
		$C_L = 3\ \mu\text{F}$	38			38			177			
$t_f$ $V_{OUT}$ fall time	$R_L = 500\ \Omega$	$C_L = 0.1\ \mu\text{F}$	122			16			16			$\mu\text{s}$
		$C_L = 1\ \mu\text{F}$	1086			147			147			
		$C_L = 3\ \mu\text{F}$	3600			430			430			

### 8.12 Switching Characteristics: $V_{IN} = 3\text{ V}$

 $V_{IN} = 3\text{ V}$ ,  $T_A = 25^\circ\text{C}$  (unless otherwise noted)

PARAMETER	TEST CONDITIONS	TPS22921			TPS22922			TPS22922B			UNIT	
		MIN	TYP	MAX	MIN	TYP	MAX	MIN	TYP	MAX		
$t_{ON}$ Turn-ON time	$R_L = 500\ \Omega$	$C_L = 0.1\ \mu\text{F}$	30			30			182			$\mu\text{s}$
		$C_L = 1\ \mu\text{F}$	38			38			201			
		$C_L = 3\ \mu\text{F}$	45			45			221			
$t_{OFF}$ Turn-OFF time	$R_L = 500\ \Omega$	$C_L = 0.1\ \mu\text{F}$	40			10			10			$\mu\text{s}$
		$C_L = 1\ \mu\text{F}$	353			51			51			
		$C_L = 3\ \mu\text{F}$	1036			139			139			
$t_r$ $V_{OUT}$ rise time	$R_L = 500\ \Omega$	$C_L = 0.1\ \mu\text{F}$	20			20			149			$\mu\text{s}$
		$C_L = 1\ \mu\text{F}$	25			25			150			
		$C_L = 3\ \mu\text{F}$	33			33			161			
$t_f$ $V_{OUT}$ fall time	$R_L = 500\ \Omega$	$C_L = 0.1\ \mu\text{F}$	104			15			15			$\mu\text{s}$
		$C_L = 1\ \mu\text{F}$	1030			143			143			
		$C_L = 3\ \mu\text{F}$	3230			419			419			

### 8.13 Switching Characteristics: $V_{IN} = 3.6\text{ V}$

 $V_{IN} = 3.6\text{ V}$ ,  $T_A = 25^\circ\text{C}$  (unless otherwise noted)

PARAMETER	TEST CONDITIONS	TPS22921			TPS22922			TPS22922B			UNIT	
		MIN	TYP	MAX	MIN	TYP	MAX	MIN	TYP	MAX		
$t_{ON}$ Turn-ON time	$R_L = 500\ \Omega$	$C_L = 0.1\ \mu\text{F}$	30			30			159			$\mu\text{s}$
		$C_L = 1\ \mu\text{F}$	38			38			175			
		$C_L = 3\ \mu\text{F}$	45			45			193			
$t_{OFF}$ Turn-OFF time	$R_L = 500\ \Omega$	$C_L = 0.1\ \mu\text{F}$	42			10			10			$\mu\text{s}$
		$C_L = 1\ \mu\text{F}$	310			51			51			
		$C_L = 3\ \mu\text{F}$	988			139			139			
$t_r$ $V_{OUT}$ rise time	$R_L = 500\ \Omega$	$C_L = 0.1\ \mu\text{F}$	20			20			137			$\mu\text{s}$
		$C_L = 1\ \mu\text{F}$	25			25			138			
		$C_L = 3\ \mu\text{F}$	33			33			148			
$t_f$ $V_{OUT}$ fall time	$R_L = 500\ \Omega$	$C_L = 0.1\ \mu\text{F}$	120			15			15			$\mu\text{s}$
		$C_L = 1\ \mu\text{F}$	1100			143			143			
		$C_L = 3\ \mu\text{F}$	3600			419			419			

## 8.14 Typical Characteristics

### 8.14.1 Typical DC Characteristics

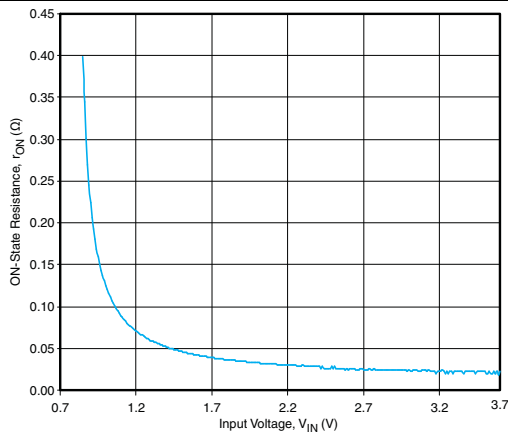

Figure 1.  $r_{ON}$  vs  $V_{IN}$

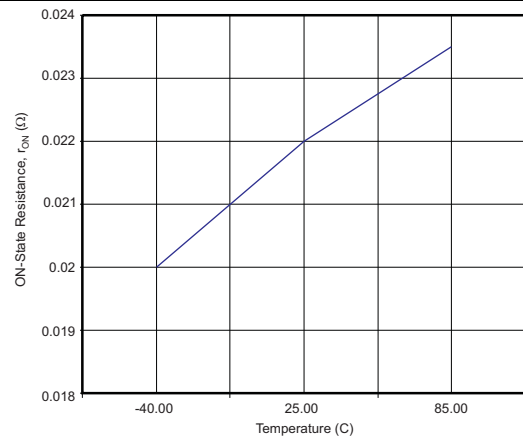

Figure 2.  $r_{ON}$  vs Temperature ( $V_{IN} = 3.3$  V)

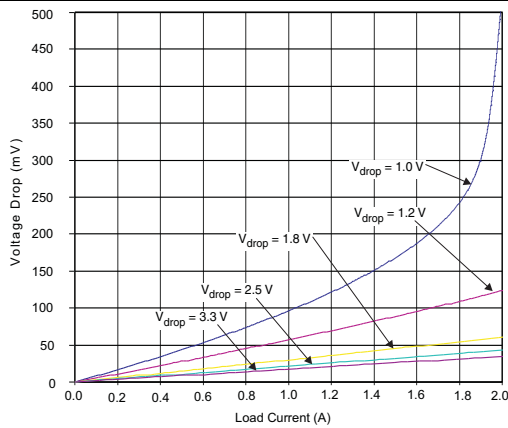

Figure 3. Voltage Drop vs Load Current

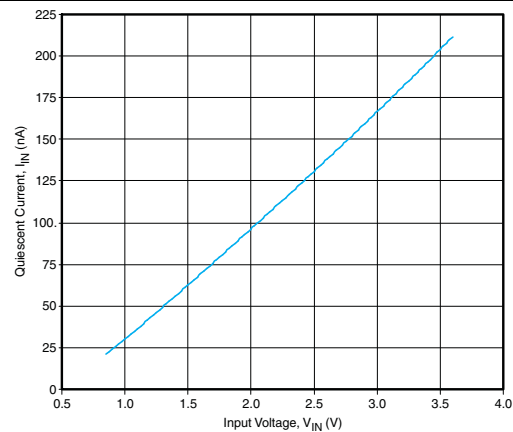

Figure 4. Quiescent Current vs  $V_{IN}$  ( $V_{ON} = V_{IN}$ )

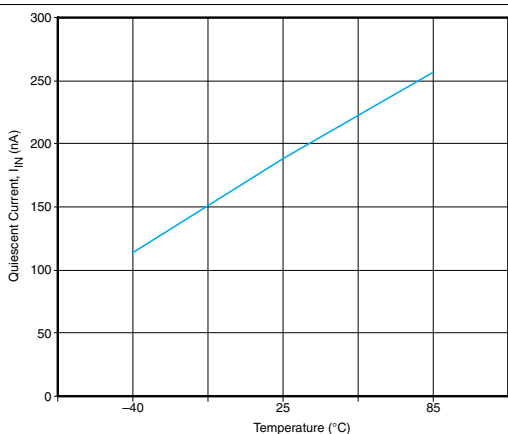

Figure 5. Quiescent Current vs Temperature ( $V_{IN} = 3.3$  V,  $I_{OUT} = 0$  mA)

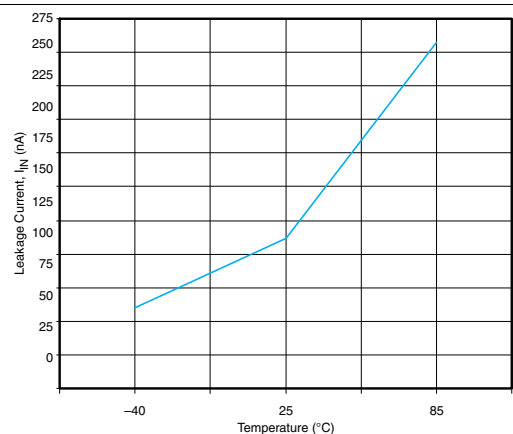

Figure 6.  $I_{IN}$  Leakage Current vs Temperature ( $V_{IN} = 3.3$  V)

Typical DC Characteristics (continued)

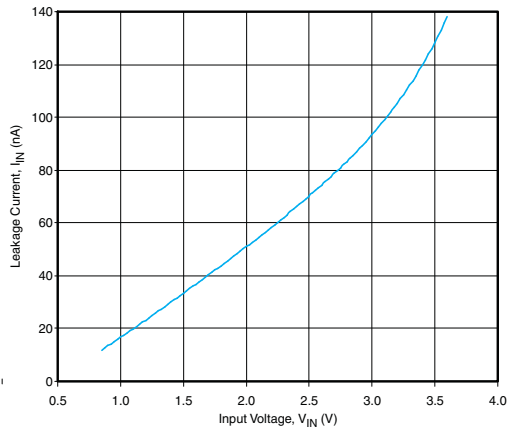

Figure 7. Leakage Current vs  $V_{IN}$

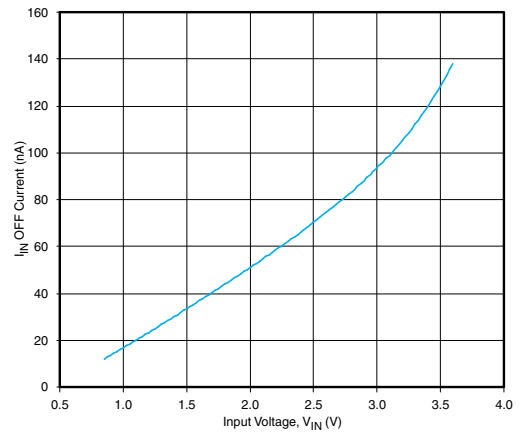

Figure 8.  $I_{IN}$  (OFF) vs  $V_{IN}$  ( $V_{ON} = 0$  V)

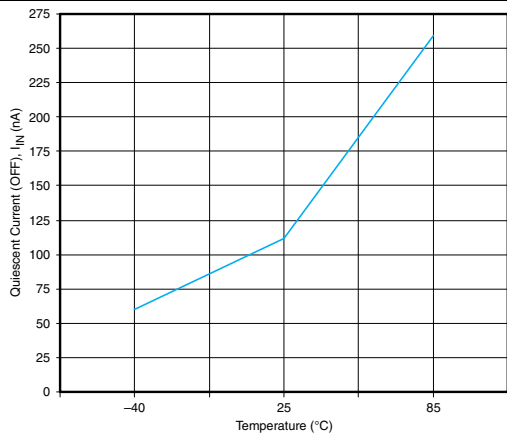

Figure 9.  $I_{IN}$  (OFF) vs Temperature ( $V_{IN} = 3.3$  V)

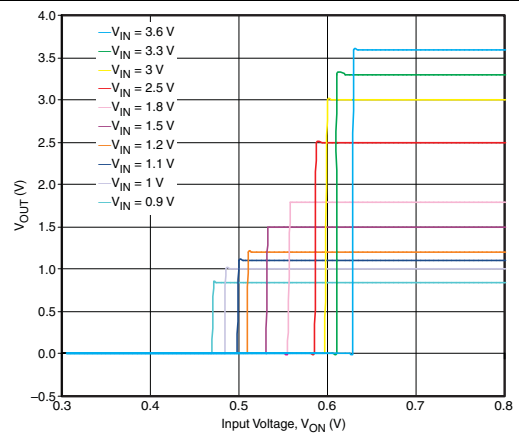

Figure 10. ON-Input Threshold

8.14.2 Typical AC Characteristics (TPS22921)

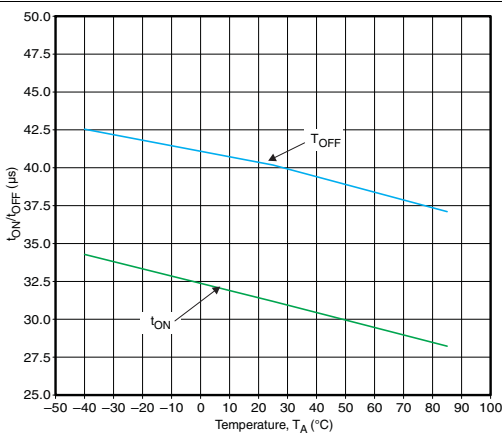

Figure 11.  $t_{ON}/t_{OFF}$  vs Temperature ( $V_{IN} = 3.3$  V)

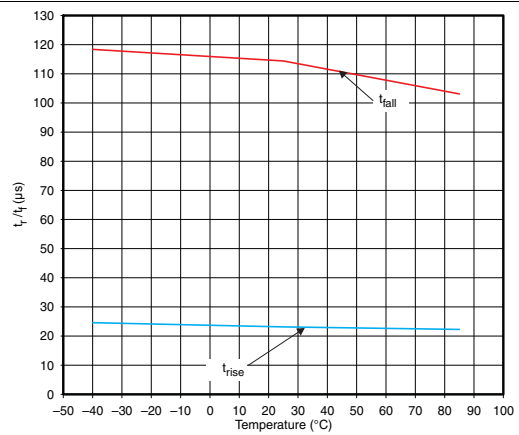
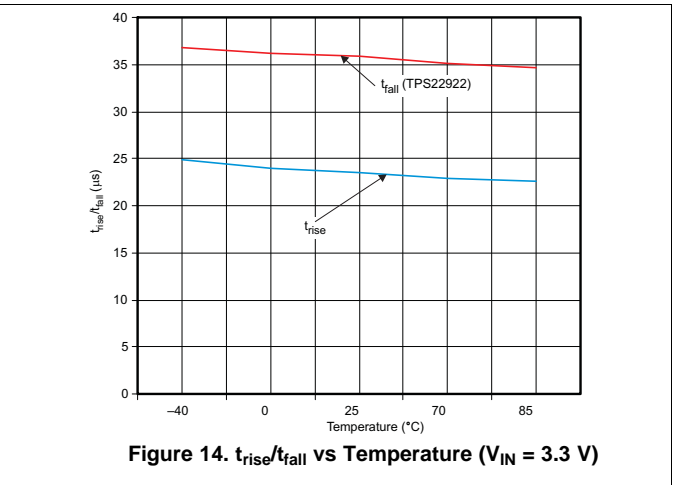
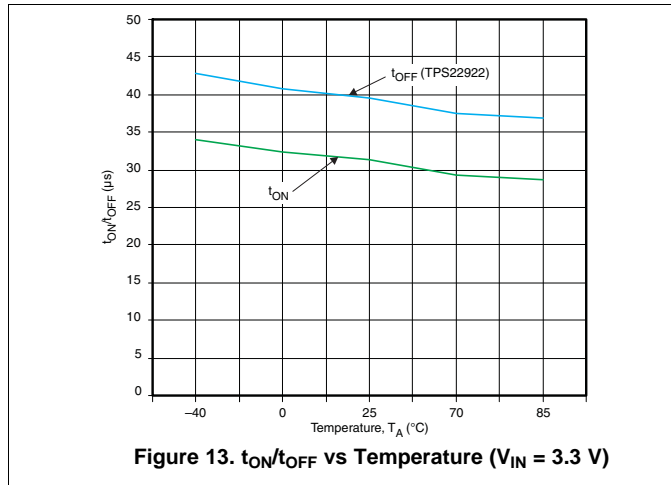
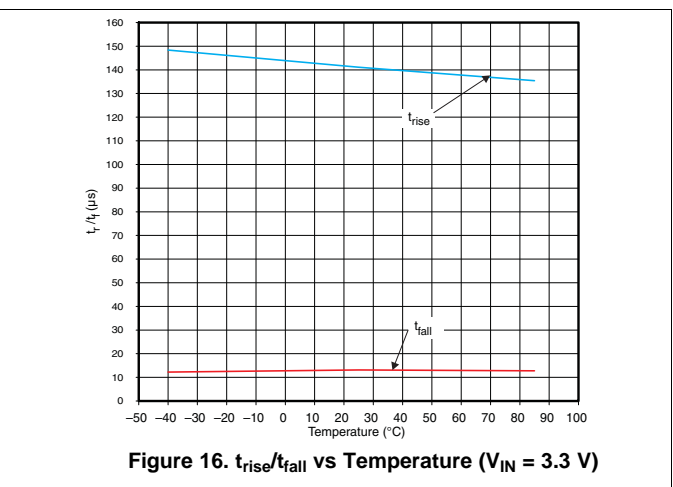
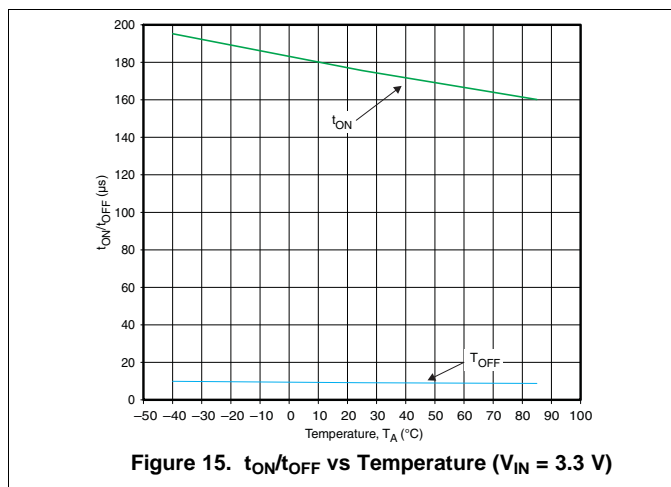

Figure 12.  $t_{rise}/t_{fall}$  vs Temperature ( $V_{IN} = 3.3$  V)

### 8.14.3 Typical AC Characteristics (TPS22922)



### 8.14.4 Typical AC Characteristics (TPS22922B)



### 8.14.5 Typical AC Characteristics (TPS22921 and TPS22922)

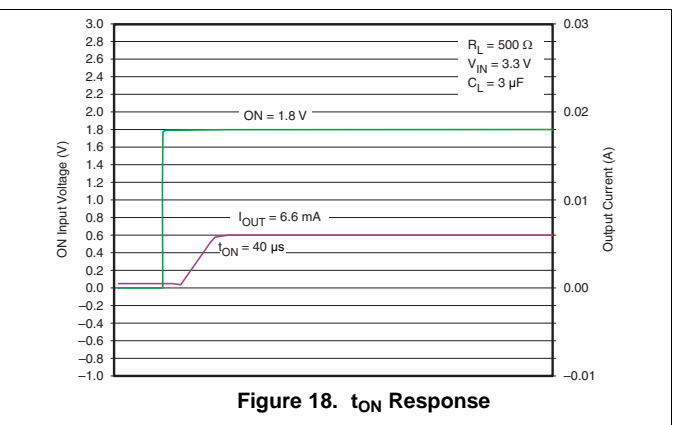
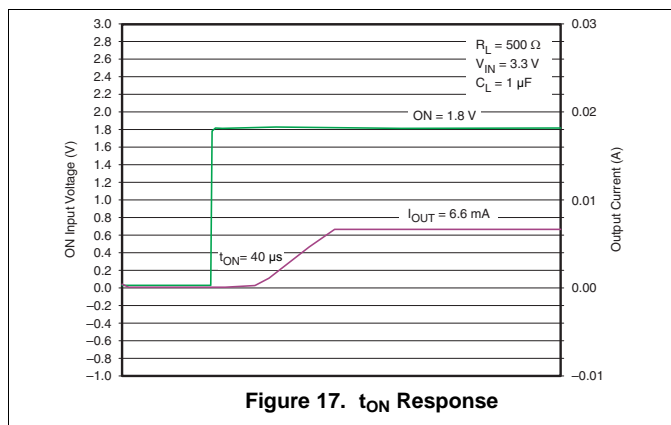

Typical AC Characteristics (TPS22921 and TPS22922) (continued)

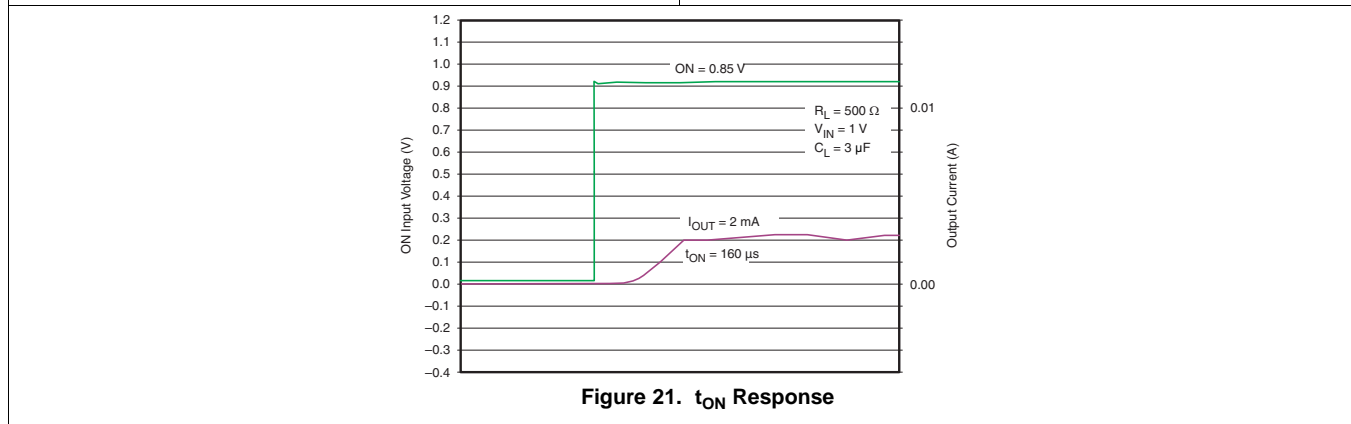
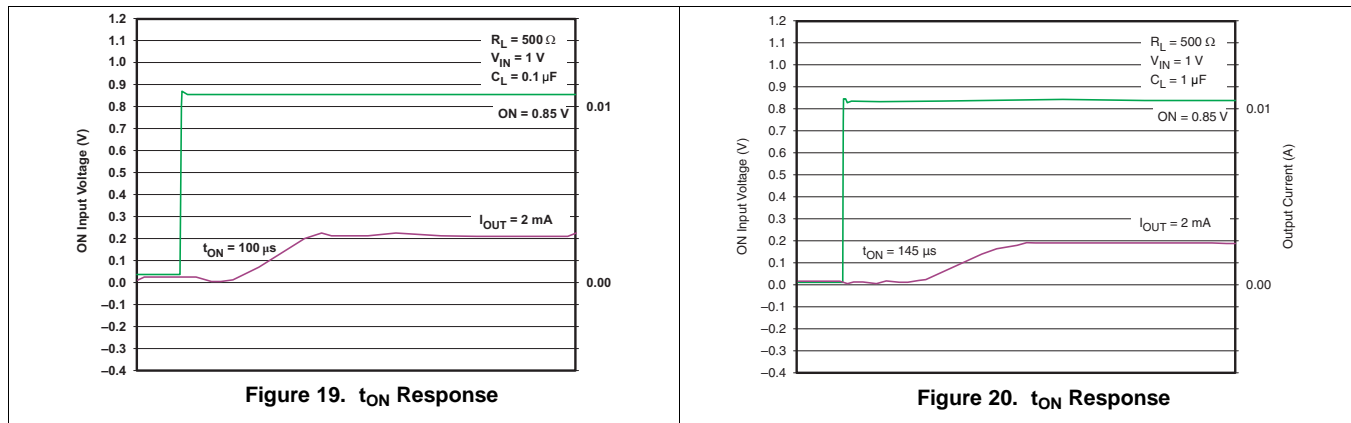

8.14.6 Typical AC Characteristics (TPS22921)

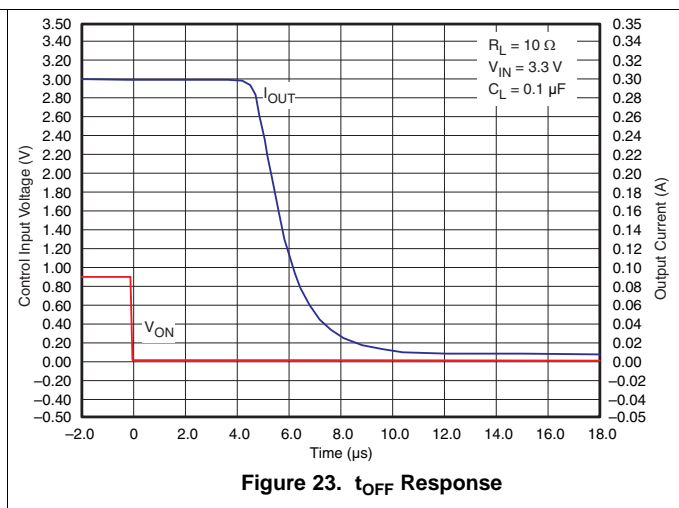
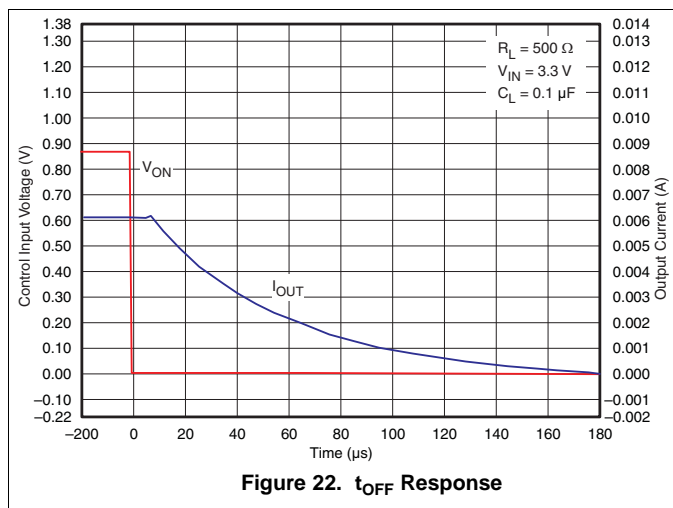

Typical AC Characteristics (TPS22921) (continued)

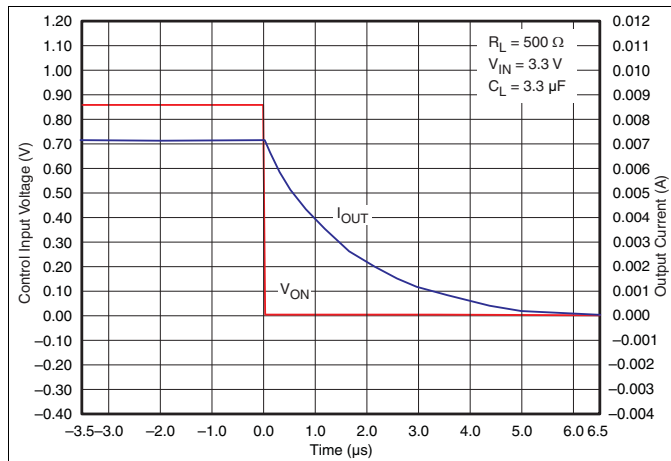

Figure 24.  $t_{OFF}$  Response

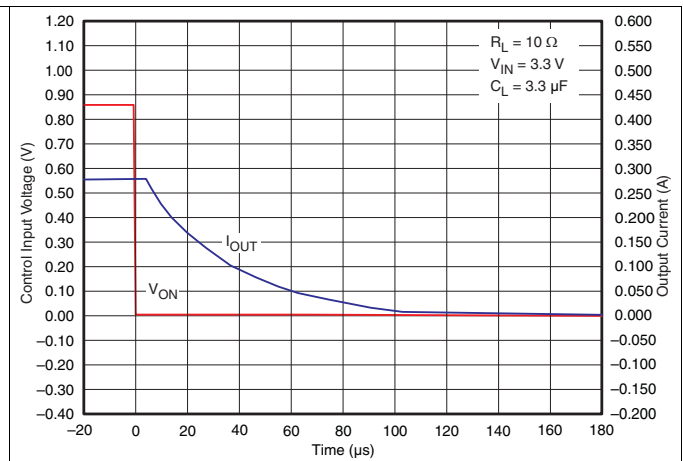

Figure 25.  $t_{OFF}$  Response

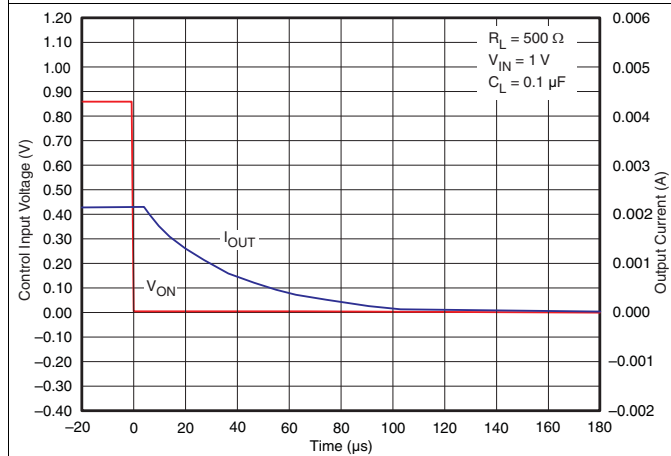

Figure 26.  $t_{OFF}$  Response

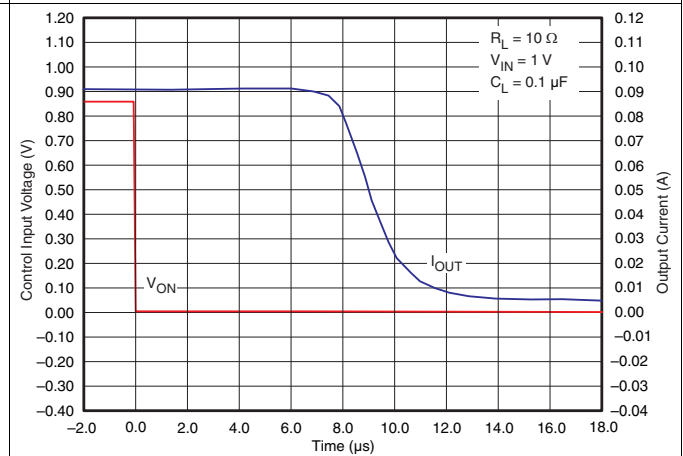

Figure 27.  $t_{OFF}$  Response

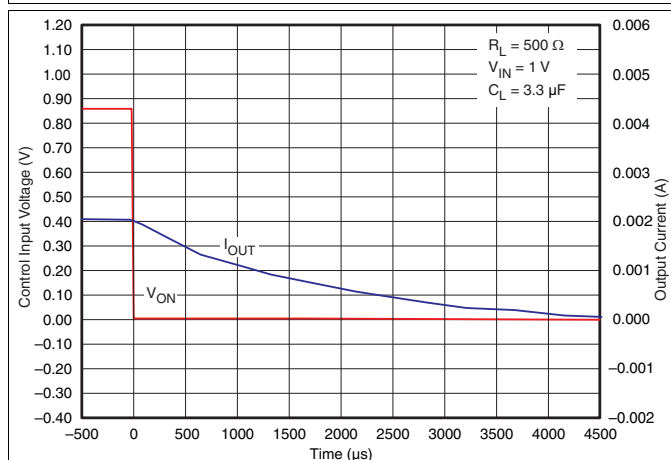

Figure 28.  $t_{OFF}$  Response

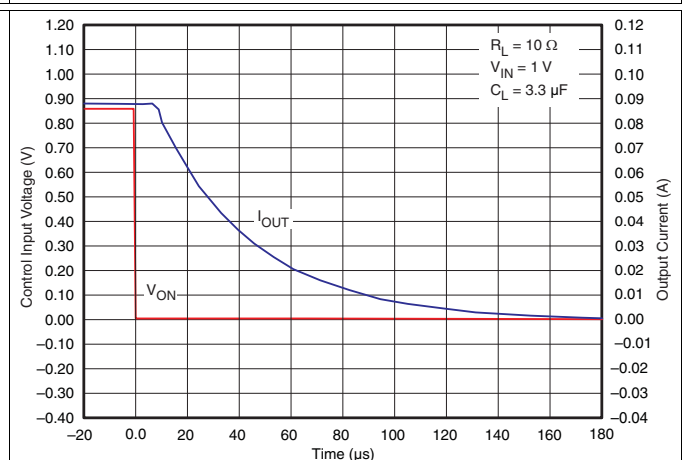

Figure 29.  $t_{OFF}$  Response

8.14.7 Typical AC Characteristics (TPS22922)

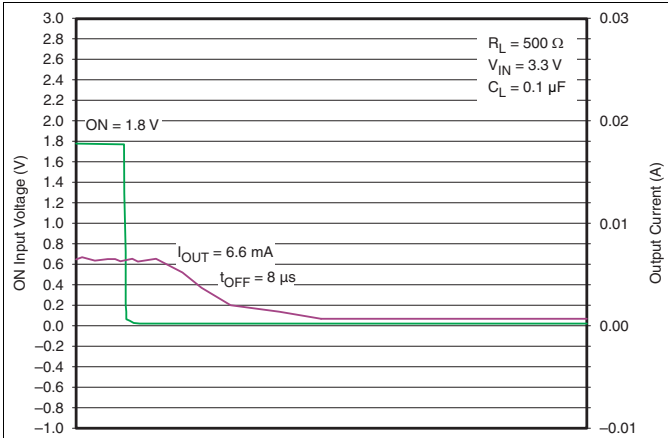

Figure 30.  $t_{OFF}$  Response

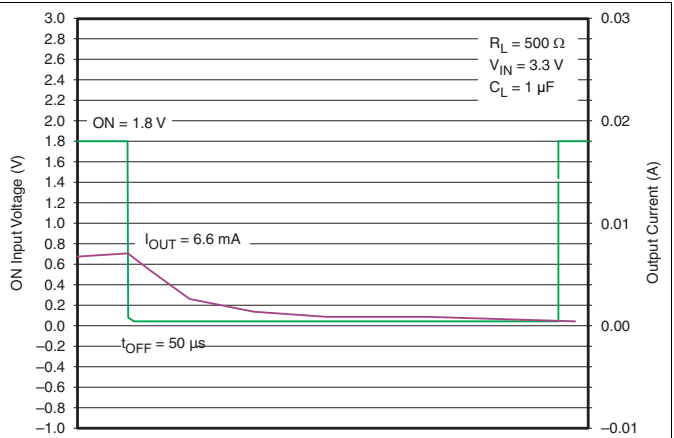

Figure 31.  $t_{OFF}$  Response

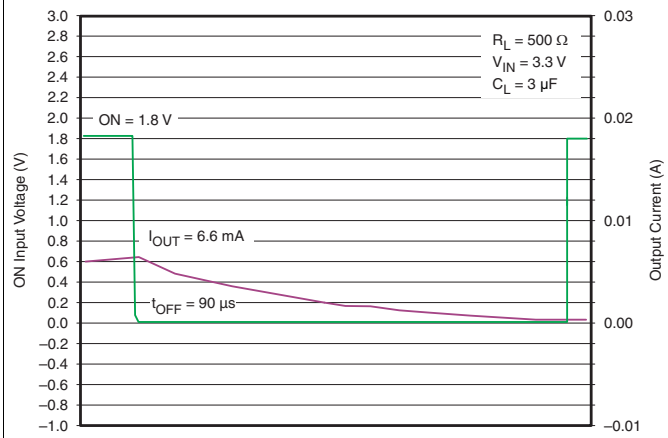

Figure 32.  $t_{OFF}$  Response

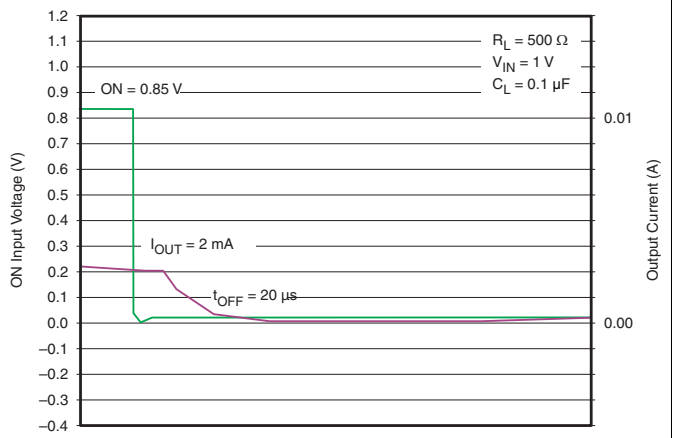

Figure 33.  $t_{OFF}$  Response

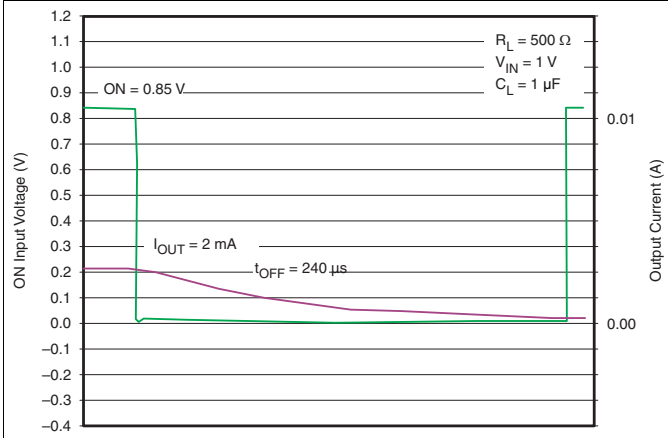

Figure 34.  $t_{OFF}$  Response

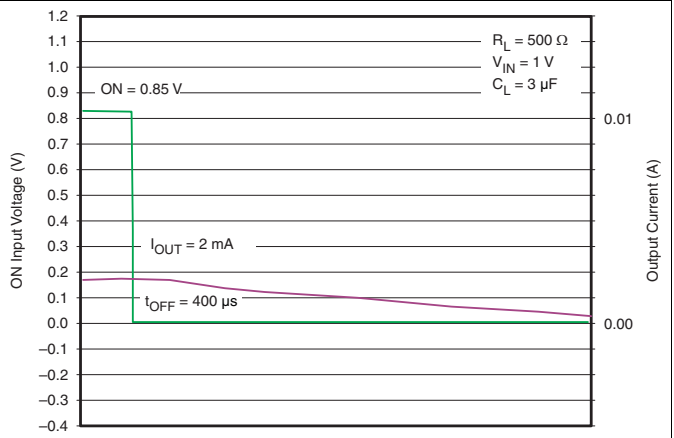

Figure 35.  $t_{OFF}$  Response

8.14.8 Typical AC Characteristics (TPS22922B)

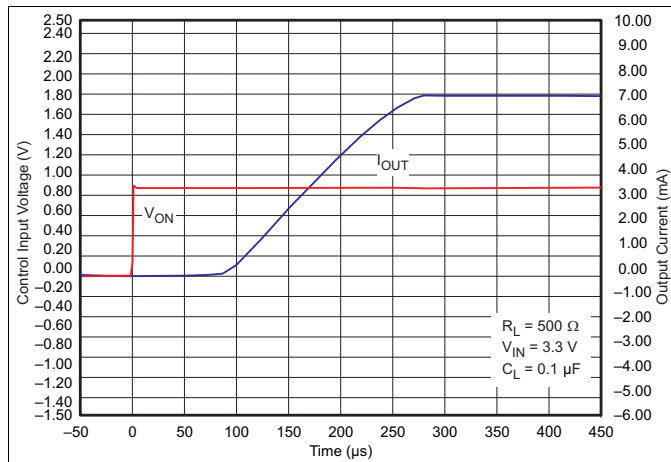

Figure 36.  $t_{ON}$  Response

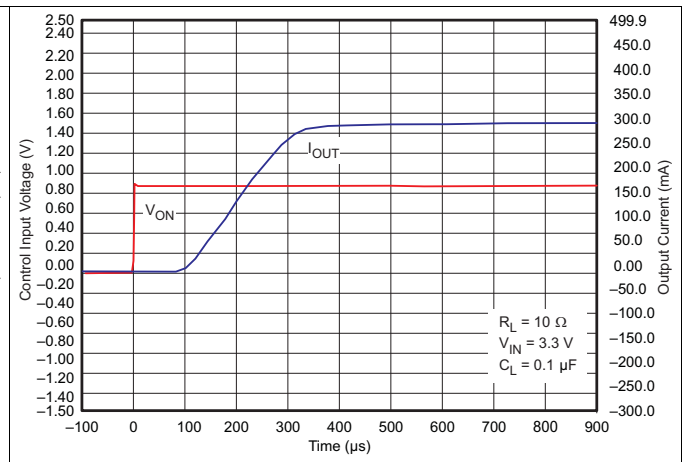

Figure 37.  $t_{ON}$  Response

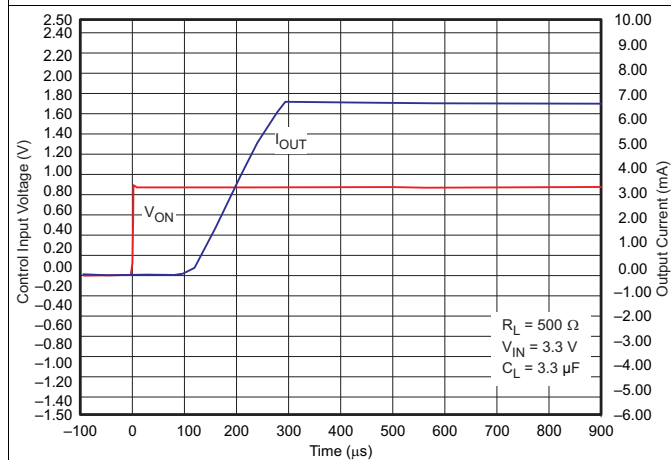

Figure 38.  $t_{ON}$  Response

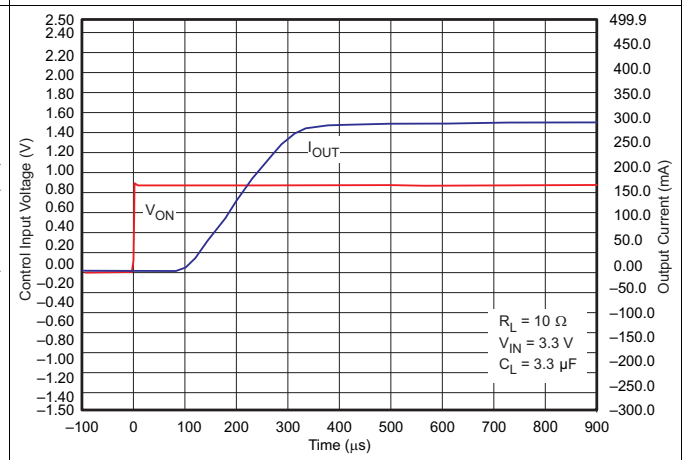

Figure 39.  $t_{ON}$  Response

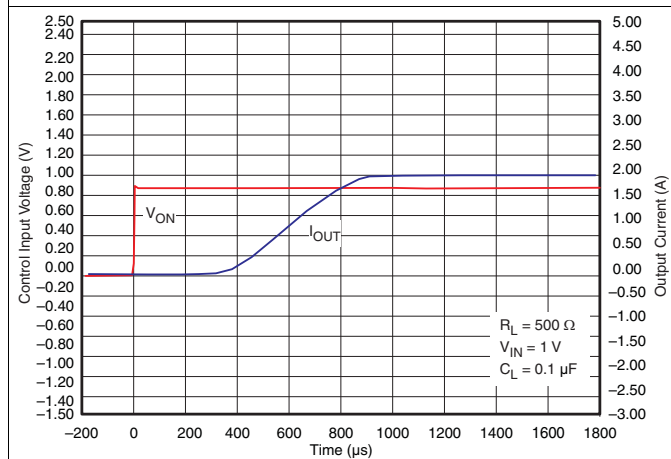

Figure 40.  $t_{ON}$  Response

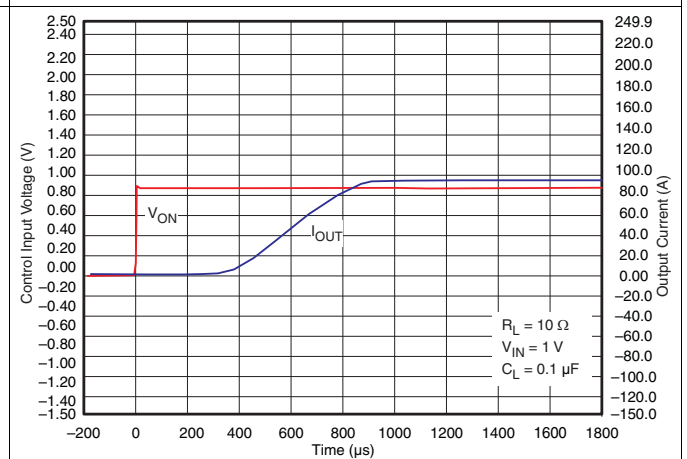

Figure 41.  $t_{ON}$  Response

Typical AC Characteristics (TPS22922B) (continued)

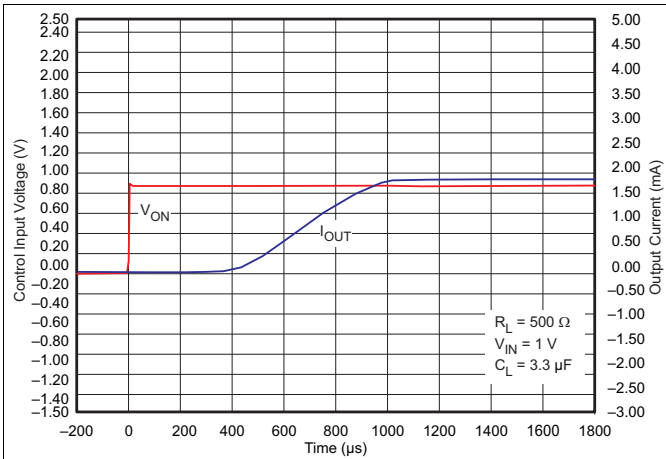

Figure 42.  $t_{ON}$  Response

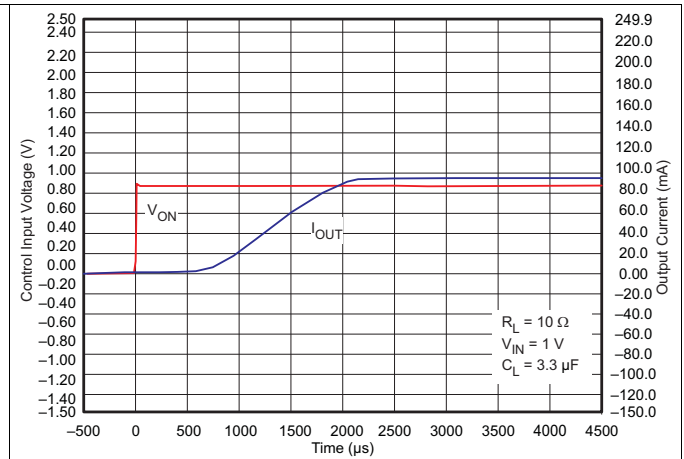

Figure 43.  $t_{ON}$  Response

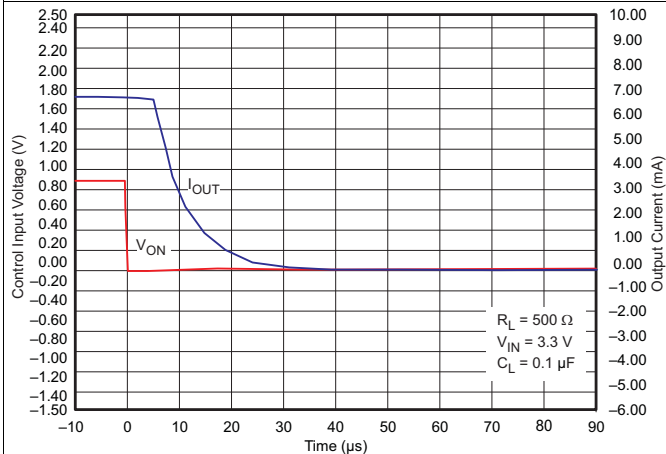

Figure 44.  $t_{OFF}$  Response

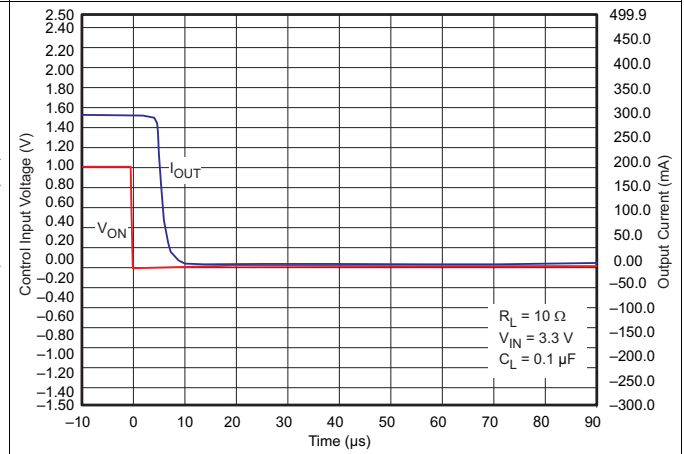

Figure 45.  $t_{OFF}$  Response

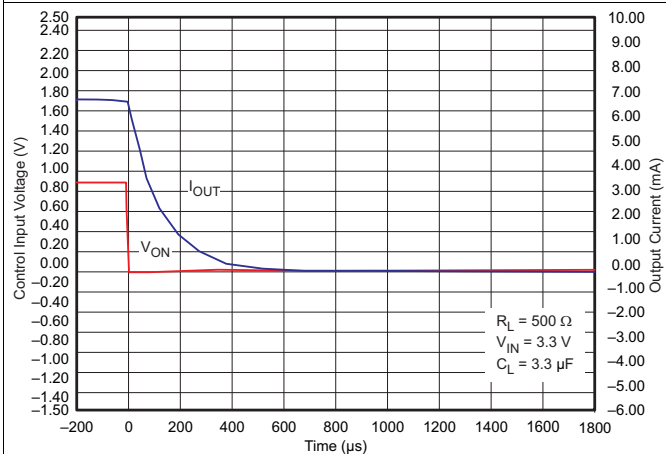

Figure 46.  $t_{OFF}$  Response

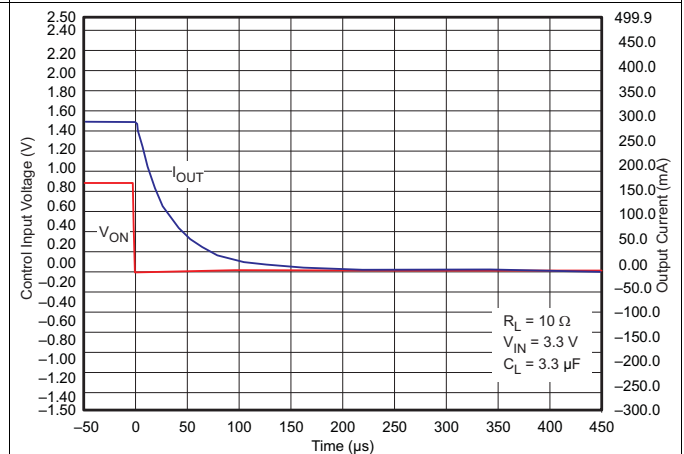

Figure 47.  $t_{OFF}$  Response

Typical AC Characteristics (TPS22922B) (continued)

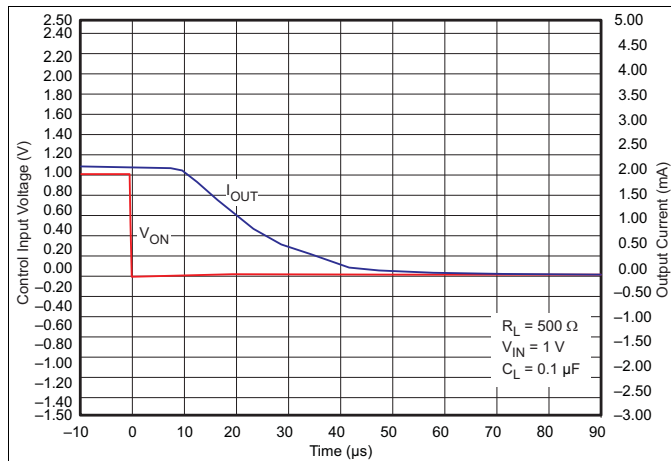

Figure 48.  $t_{OFF}$  Response

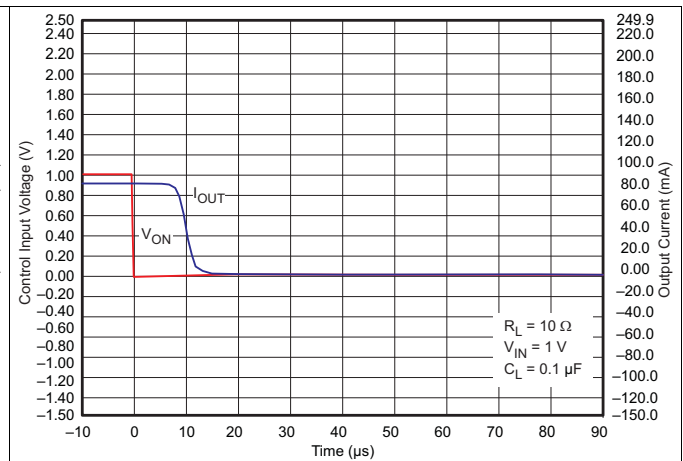

Figure 49.  $t_{OFF}$  Response

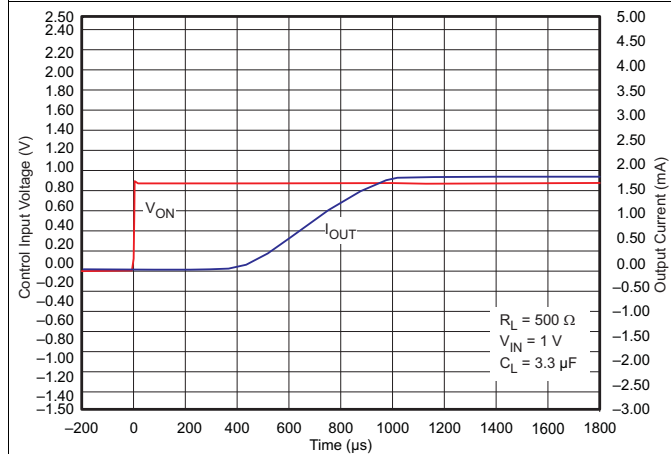

Figure 50.  $t_{ON}$  Response

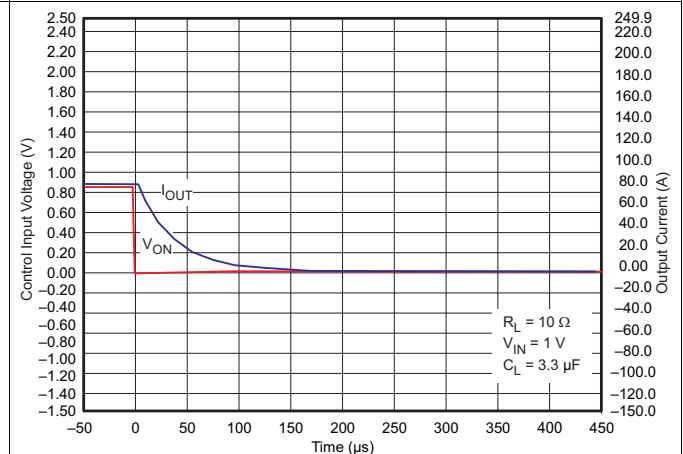
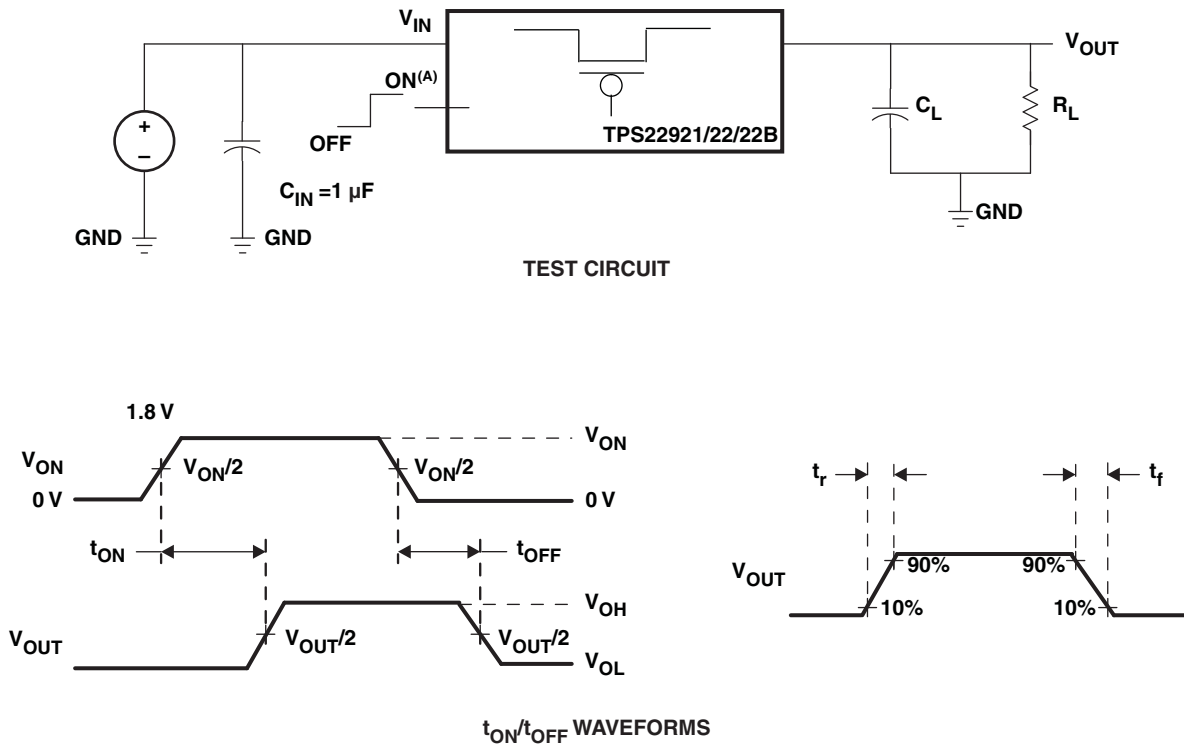

Figure 51.  $t_{OFF}$  Response

## 9 Parameter Measurement Information



A.  $t_{rise}$  and  $t_{fall}$  of the control signal is 100 ns.

**Figure 52. Test Circuit and  $t_{ON}/t_{OFF}$  Waveforms**

## 10 Detailed Description

### 10.1 Overview

The TPS2292x is a single-channel, 2-A load switch in a small, space-saving CSP-6 package. These devices implement a P-channel MOSFET to provide a low ON-resistance for a low voltage drop across the device. A controlled rise time is used in applications to limit the inrush current.

### 10.2 Functional Block Diagram

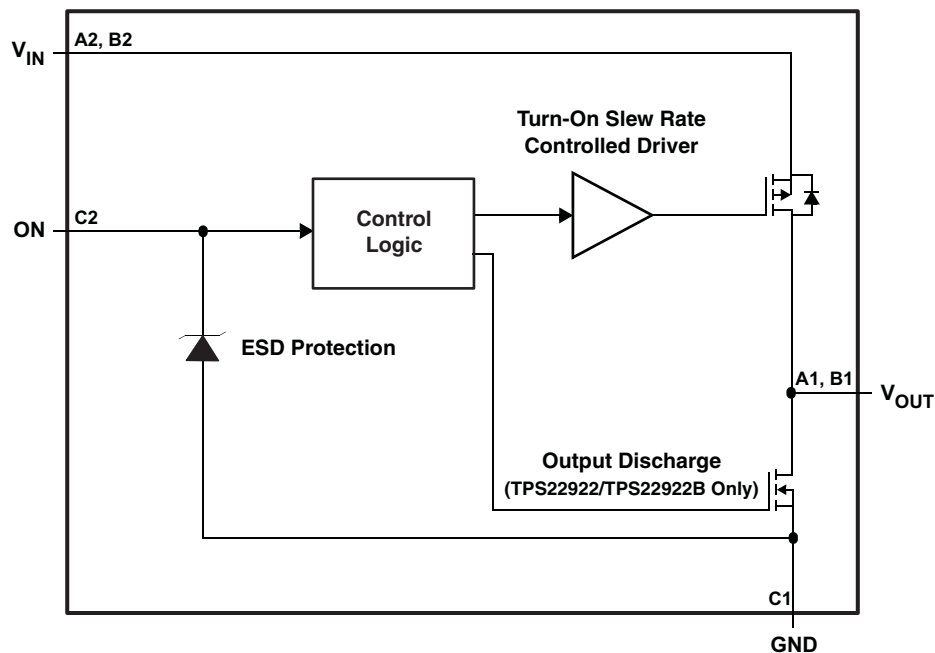

### 10.3 Feature Description

#### 10.3.1 ON/OFF Control

The ON pin controls the state of the switch. Activating ON continuously holds the switch in the on state. ON is active high and has a low threshold making it capable of interfacing with low-voltage signals. The ON pin is compatible with standard GPIO logic threshold, and it can be used with any microcontroller with 1.2-V, 1.8-V, 2.5-V or 3.3-V GPIOs.

#### 10.3.2 Quick Output Discharge

The TPS22922 and TPS22922B includes the Quick Output Discharge (QOD) feature. When the switch is disabled, a discharge resistance with a typical value of 65  $\Omega$  is connected between the output and ground. This resistance pulls down the output and prevents it from floating when the device is disabled.

### 10.4 Device Functional Modes

Table 1 lists the VOUT pin connections to for a particular device as determined by the ON pin.

**Table 1. VOUT Function Table**

ON	TPS22921	TPS22922/2B
L	Open	GND
H	VIN	VIN

## 11 Application and Implementation

### NOTE

Information in the following applications sections is not part of the TI component specification, and TI does not warrant its accuracy or completeness. TI's customers are responsible for determining suitability of components for their purposes. Customers should validate and test their design implementation to confirm system functionality.

### 11.1 Application Information

#### 11.1.1 Input Capacitor (Optional)

To limit the voltage drop on the input supply caused by transient inrush currents when the switch turns on into a discharged load capacitor, a capacitor must be placed between  $V_{IN}$  and GND. A 1- $\mu\text{F}$  ceramic capacitor,  $C_{IN}$ , placed close to the pins is usually sufficient. Higher values of  $C_{IN}$  can be used to further reduce the voltage drop during higher current application. When switching a heavy load, TI recommends using an input capacitor about 10 or more times higher than the output capacitor in order to avoid any supply drop.

#### 11.1.2 Output Capacitor (Optional)

Because of the integral body diode in the PMOS switch, a  $C_{IN}$  greater than  $C_L$  is highly recommended. A  $C_L$  greater than  $C_{IN}$  can cause  $V_{OUT}$  to exceed  $V_{IN}$  when the system supply is removed. This could result in current flow through the body diode from  $V_{OUT}$  to  $V_{IN}$ .

### 11.2 Typical Application

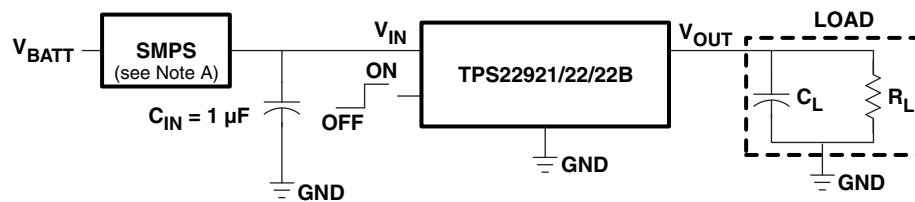

A. Switched-mode power supply

Figure 53. Typical Application

#### 11.2.1 Design Requirements

Table 2. Design Parameters

DESIGN PARAMETER	EXAMPLE VALUE
$V_{IN}$	1.8 V
$C_L$	4.7 $\mu\text{F}$
Load current	2 A
Ambient Temperature	25 $^{\circ}\text{C}$
Maximum inrush current	200 mA

## 11.2.2 Detailed Design Procedure

### 11.2.2.1 Managing Inrush Current

When the switch is enabled, the output capacitors must be charged up from 0 V to the set value (1.8 V in this example). This charge arrives in the form of inrush current. Inrush current can be calculated using the following equation:

$$I_{\text{INRUSH}} = C_L \times \frac{dV_{\text{OUT}}}{dt}$$

where

- $C_L$  = Output capacitance
- $dV_{\text{OUT}}$  = Output voltage
- $dt$  = Rise time

(1)

The TPS22921/2/2B offers a controlled rise time for minimizing inrush current. This device can be selected based upon the minimum acceptable rise time which can be calculated using the design requirements and the inrush current equation. An output capacitance of 4.7  $\mu\text{F}$  will be used because the amount of inrush current increases with output capacitance:

$$200 \text{ mA} = 4.7 \mu\text{F} \times 1.8\text{V} / dt$$

where

- $dt = 42.3 \mu\text{s}$

(2)

To ensure an inrush current of less than 200 mA, a device with a rise time greater than 42.3  $\mu\text{s}$  must be used. The TPS22922B has a typical rise time of 200  $\mu\text{s}$  at 1.8 V which meets the above design requirements. The TPS22921/2 has a faster rise time of 30  $\mu\text{s}$  at 1.8 V, and this would result in an inrush current larger than desired.

### 11.2.2.2 VIN to VOUT Voltage Drop

The voltage drop from VIN to VOUT is determined by the ON-resistance of the device and the load current.  $R_{\text{ON}}$  can be found in [Electrical Characteristics](#) and is dependent on temperature. When the value of  $R_{\text{ON}}$  is found, the following equation can be used to calculate the voltage drop across the device:

$$\Delta V = I_{\text{LOAD}} \times R_{\text{ON}}$$

where

- $\Delta V$  = Voltage drop across the device
- $I_{\text{LOAD}}$  = Load current
- $R_{\text{ON}}$  = ON-resistance of the device

(3)

At  $V_{\text{IN}} = 1.8 \text{ V}$ , the TPS22921/2/2B has an  $R_{\text{ON}}$  value of 33 m $\Omega$ . Using this value and the defined load current, the above equation can be evaluated:

$$\Delta V = 2 \text{ A} \times 33 \text{ m}\Omega$$

where

- $\Delta V = 66 \text{ mV}$

(4)

Therefore, the voltage drop across the device will be 66 mV.

### 11.2.3 Application Curve

Figure 54 shows the expected voltage drop across the device for different load currents and input voltages.

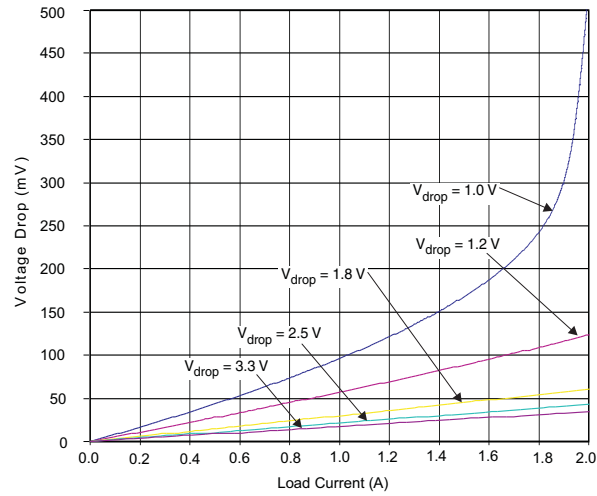

**Figure 54. Voltage Drop vs Load Current**

## 12 Power Supply Recommendations

The device is designed to operate with a  $V_{IN}$  range of 0.9 V to 3.6 V. This supply must be well regulated and placed as close to the device terminals as possible. It must also be able to withstand all transient and load currents, using a recommended input capacitance of 1  $\mu\text{F}$  if necessary. If the supply is located more than a few inches from the device terminals, additional bulk capacitance may be required in addition to the ceramic bypass capacitors. If additional bulk capacitance is required, an electrolytic, tantalum, or ceramic capacitor of 10  $\mu\text{F}$  may be sufficient.

## 13 Layout

### 13.1 Layout Guidelines

For best performance,  $V_{IN}$ ,  $V_{OUT}$ , and GND traces should be as short and wide as possible to help minimize the parasitic electrical effects. To be most effective, the input and output capacitors should be placed close to the device to minimize the effects that parasitic trace inductances may have on normal operation.

For higher reliability, the maximum IC junction temperature,  $T_{J(max)}$ , should be restricted to 125°C under normal operating conditions. Junction temperature is directly proportional to power dissipation in the device and the two are related by

$$T_J = T_A + \theta_{JA} \times P_D$$

where

- $T_J$  = Junction temperature of the device
- $T_A$  = Ambient temperature
- $P_D$  = Power dissipation inside the device
- $\theta_{JA}$  = Junction to ambient thermal resistance. See Thermal Information section of the data sheet. This parameter is highly dependent on board layout.

(5)

### 13.2 Layout Example

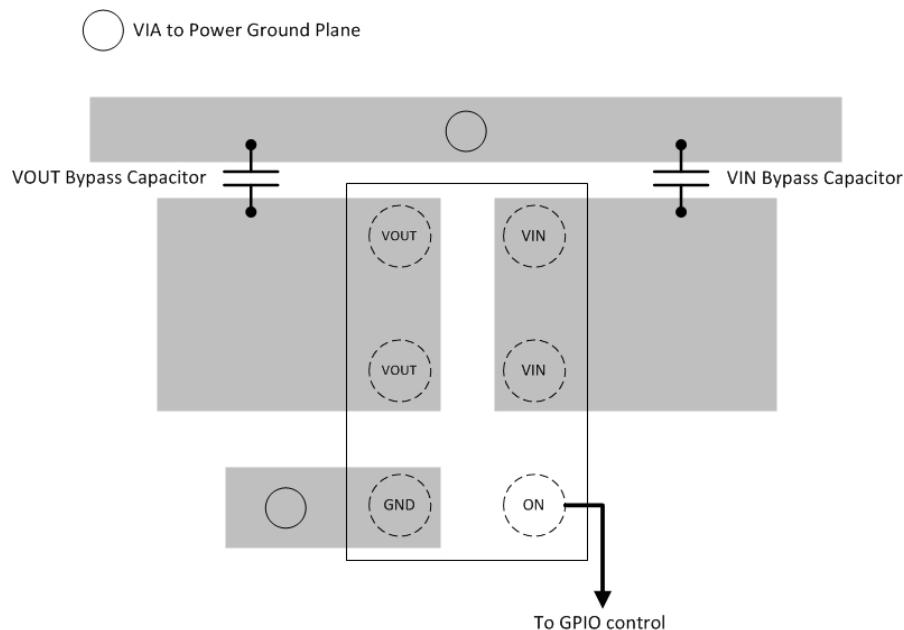

**Figure 55. Layout Recommendation**

## 14 Device and Documentation Support

### 14.1 Related Links

The table below lists quick access links. Categories include technical documents, support and community resources, tools and software, and quick access to sample or buy.

**Table 3. Related Links**

PARTS	PRODUCT FOLDER	SAMPLE & BUY	TECHNICAL DOCUMENTS	TOOLS & SOFTWARE	SUPPORT & COMMUNITY
TPS22921	<a href="#">Click here</a>	<a href="#">Click here</a>	<a href="#">Click here</a>	<a href="#">Click here</a>	<a href="#">Click here</a>
TPS22922	<a href="#">Click here</a>	<a href="#">Click here</a>	<a href="#">Click here</a>	<a href="#">Click here</a>	<a href="#">Click here</a>
TPS22922B	<a href="#">Click here</a>	<a href="#">Click here</a>	<a href="#">Click here</a>	<a href="#">Click here</a>	<a href="#">Click here</a>

### 14.2 Trademarks

All trademarks are the property of their respective owners.

### 14.3 Electrostatic Discharge Caution



These devices have limited built-in ESD protection. The leads should be shorted together or the device placed in conductive foam during storage or handling to prevent electrostatic damage to the MOS gates.

### 14.4 Glossary

[SLYZ022](#) — *TI Glossary*.

This glossary lists and explains terms, acronyms, and definitions.

## 15 Mechanical, Packaging, and Orderable Information

The following pages include mechanical, packaging, and orderable information. This information is the most current data available for the designated devices. This data is subject to change without notice and revision of this document. For browser-based versions of this data sheet, refer to the left-hand navigation.

**PACKAGING INFORMATION**

Orderable Device	Status (1)	Package Type	Package Drawing	Pins	Package Qty	Eco Plan (2)	Lead finish/ Ball material (6)	MSL Peak Temp (3)	Op Temp (°C)	Device Marking (4/5)	Samples
TPS22921YFPR	ACTIVE	DSBGA	YFP	6	3000	RoHS & Green	SNAGCU	Level-1-260C-UNLIM	-40 to 85	(3Y, 3Y3)	<a href="#">Samples</a>
TPS22921YZPR	ACTIVE	DSBGA	YZP	6	3000	RoHS & Green	SNAGCU	Level-1-260C-UNLIM	-40 to 85	(3Y3, 3Y5)	<a href="#">Samples</a>
TPS22921YZTR	ACTIVE	DSBGA	YZT	6	3000	RoHS & Green	SNAGCU	Level-1-260C-UNLIM	-40 to 85	(3Y3, 3Y5)	<a href="#">Samples</a>
TPS22922BYFPR	ACTIVE	DSBGA	YFP	6	3000	RoHS & Green	SNAGCU	Level-1-260C-UNLIM		(3Z, 3Z3)	<a href="#">Samples</a>
TPS22922BYZPR	ACTIVE	DSBGA	YZP	6	3000	RoHS & Green	SNAGCU	Level-1-260C-UNLIM	-40 to 85	(3Z, 3Z3)	<a href="#">Samples</a>
TPS22922YFPR	ACTIVE	DSBGA	YFP	6	3000	RoHS & Green	SNAGCU	Level-1-260C-UNLIM		(2Z, 2Z3)	<a href="#">Samples</a>
TPS22922YZPR	ACTIVE	DSBGA	YZP	6	3000	RoHS & Green	SNAGCU	Level-1-260C-UNLIM	-40 to 85	(2Z, 2Z3)	<a href="#">Samples</a>

(1) The marketing status values are defined as follows:

**ACTIVE:** Product device recommended for new designs.

**LIFEBUY:** TI has announced that the device will be discontinued, and a lifetime-buy period is in effect.

**NRND:** Not recommended for new designs. Device is in production to support existing customers, but TI does not recommend using this part in a new design.

**PREVIEW:** Device has been announced but is not in production. Samples may or may not be available.

**OBSOLETE:** TI has discontinued the production of the device.

(2) **RoHS:** TI defines "RoHS" to mean semiconductor products that are compliant with the current EU RoHS requirements for all 10 RoHS substances, including the requirement that RoHS substance do not exceed 0.1% by weight in homogeneous materials. Where designed to be soldered at high temperatures, "RoHS" products are suitable for use in specified lead-free processes. TI may reference these types of products as "Pb-Free".

**RoHS Exempt:** TI defines "RoHS Exempt" to mean products that contain lead but are compliant with EU RoHS pursuant to a specific EU RoHS exemption.

**Green:** TI defines "Green" to mean the content of Chlorine (Cl) and Bromine (Br) based flame retardants meet JS709B low halogen requirements of <=1000ppm threshold. Antimony trioxide based flame retardants must also meet the <=1000ppm threshold requirement.

(3) MSL, Peak Temp. - The Moisture Sensitivity Level rating according to the JEDEC industry standard classifications, and peak solder temperature.

(4) There may be additional marking, which relates to the logo, the lot trace code information, or the environmental category on the device.

(5) Multiple Device Markings will be inside parentheses. Only one Device Marking contained in parentheses and separated by a "~" will appear on a device. If a line is indented then it is a continuation of the previous line and the two combined represent the entire Device Marking for that device.

<sup>(6)</sup> Lead finish/Ball material - Orderable Devices may have multiple material finish options. Finish options are separated by a vertical ruled line. Lead finish/Ball material values may wrap to two lines if the finish value exceeds the maximum column width.

**Important Information and Disclaimer:**The information provided on this page represents TI's knowledge and belief as of the date that it is provided. TI bases its knowledge and belief on information provided by third parties, and makes no representation or warranty as to the accuracy of such information. Efforts are underway to better integrate information from third parties. TI has taken and continues to take reasonable steps to provide representative and accurate information but may not have conducted destructive testing or chemical analysis on incoming materials and chemicals. TI and TI suppliers consider certain information to be proprietary, and thus CAS numbers and other limited information may not be available for release.

In no event shall TI's liability arising out of such information exceed the total purchase price of the TI part(s) at issue in this document sold by TI to Customer on an annual basis.

**TAPE AND REEL INFORMATION**

**QUADRANT ASSIGNMENTS FOR PIN 1 ORIENTATION IN TAPE**

\*All dimensions are nominal

Device	Package Type	Package Drawing	Pins	SPQ	Reel Diameter (mm)	Reel Width W1 (mm)	A0 (mm)	B0 (mm)	K0 (mm)	P1 (mm)	W (mm)	Pin1 Quadrant
TPS22921YFPR	DSBGA	YFP	6	3000	180.0	8.4	0.89	1.29	0.62	4.0	8.0	Q1
TPS22921YZPR	DSBGA	YZP	6	3000	178.0	9.2	1.02	1.52	0.63	4.0	8.0	Q1
TPS22921YZTR	DSBGA	YZT	6	3000	178.0	9.2	1.02	1.52	0.75	4.0	8.0	Q1
TPS22922BYFPR	DSBGA	YFP	6	3000	178.0	9.2	0.89	1.29	0.62	4.0	8.0	Q1
TPS22922BYZPR	DSBGA	YZP	6	3000	178.0	9.2	1.02	1.52	0.63	4.0	8.0	Q1
TPS22922YFPR	DSBGA	YFP	6	3000	180.0	8.4	0.89	1.29	0.62	4.0	8.0	Q1
TPS22922YZPR	DSBGA	YZP	6	3000	178.0	9.2	1.02	1.52	0.63	4.0	8.0	Q1

**TAPE AND REEL BOX DIMENSIONS**

\*All dimensions are nominal

Device	Package Type	Package Drawing	Pins	SPQ	Length (mm)	Width (mm)	Height (mm)
TPS22921YFPR	DSBGA	YFP	6	3000	182.0	182.0	20.0
TPS22921YZPR	DSBGA	YZP	6	3000	220.0	220.0	35.0
TPS22921YZTR	DSBGA	YZT	6	3000	220.0	220.0	35.0
TPS22922BYFPR	DSBGA	YFP	6	3000	220.0	220.0	35.0
TPS22922BYZPR	DSBGA	YZP	6	3000	220.0	220.0	35.0
TPS22922YFPR	DSBGA	YFP	6	3000	182.0	182.0	20.0
TPS22922YZPR	DSBGA	YZP	6	3000	220.0	220.0	35.0

YFP0006

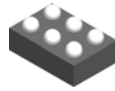

# PACKAGE OUTLINE

DSBGA - 0.5 mm max height

DIE SIZE BALL GRID ARRAY

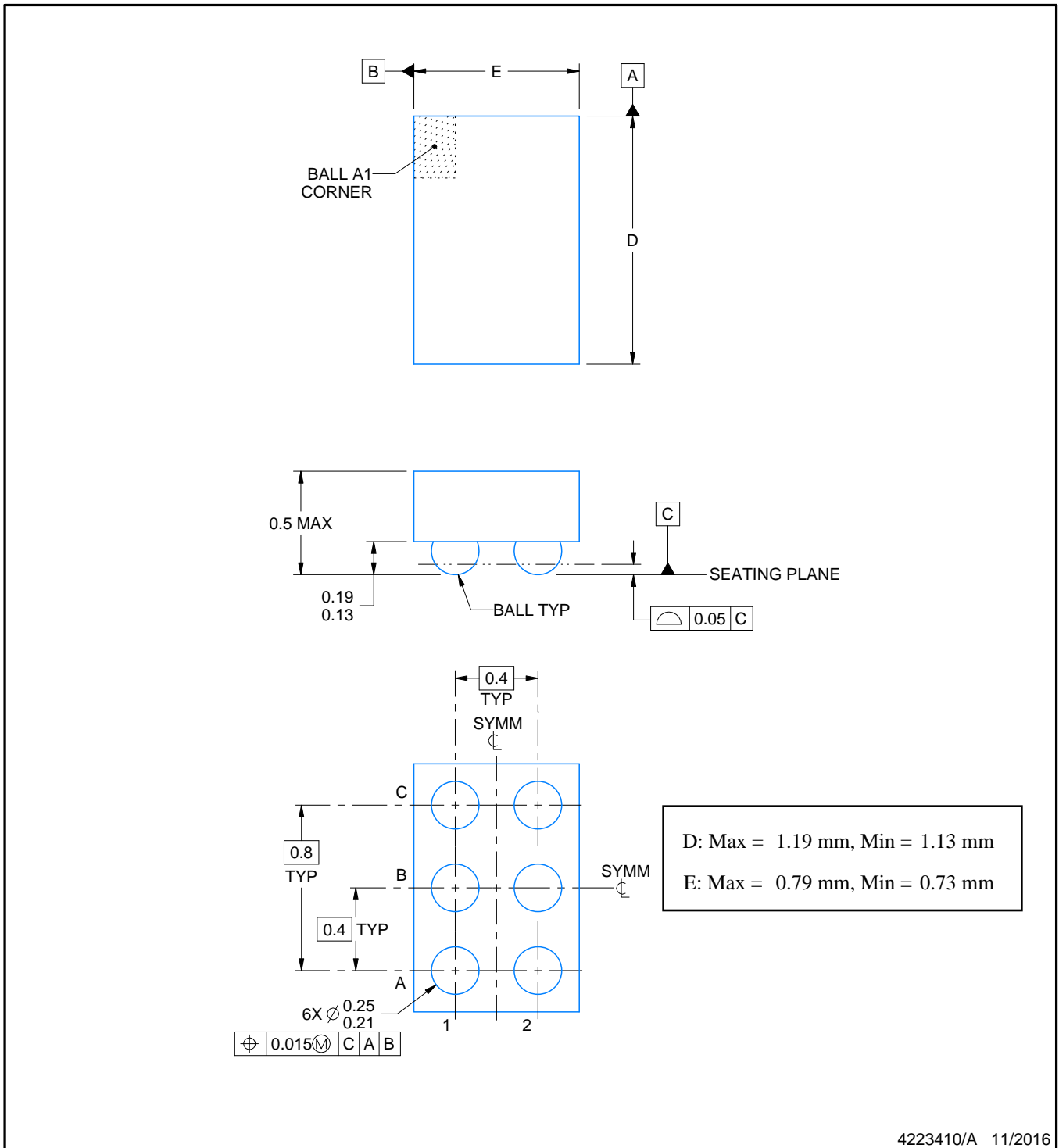

4223410/A 11/2016

NOTES:

1. All linear dimensions are in millimeters. Any dimensions in parenthesis are for reference only. Dimensioning and tolerancing per ASME Y14.5M.
2. This drawing is subject to change without notice.

# EXAMPLE BOARD LAYOUT

YFP0006

DSBGA - 0.5 mm max height

DIE SIZE BALL GRID ARRAY

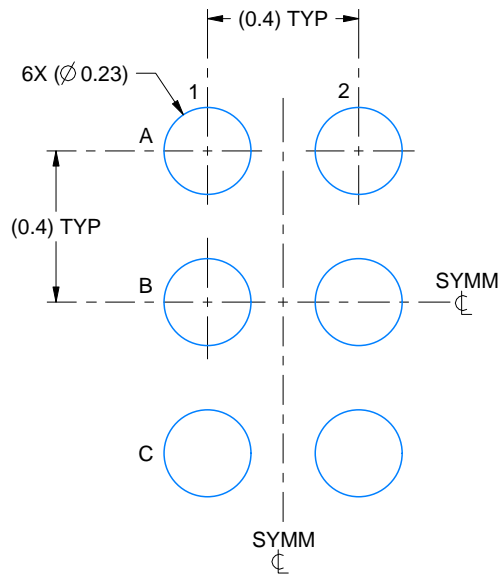

LAND PATTERN EXAMPLE  
SCALE:50X

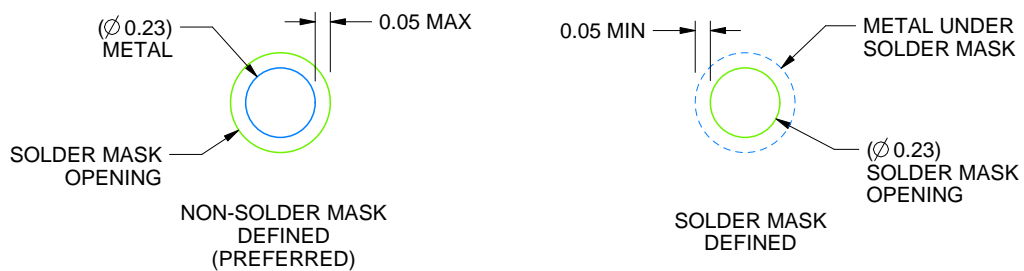

SOLDER MASK DETAILS  
NOT TO SCALE

4223410/A 11/2016

NOTES: (continued)

- Final dimensions may vary due to manufacturing tolerance considerations and also routing constraints. For more information, see Texas Instruments literature number SNVA009 ([www.ti.com/lit/snva009](http://www.ti.com/lit/snva009)).

# EXAMPLE STENCIL DESIGN

YFP0006

DSBGA - 0.5 mm max height

DIE SIZE BALL GRID ARRAY

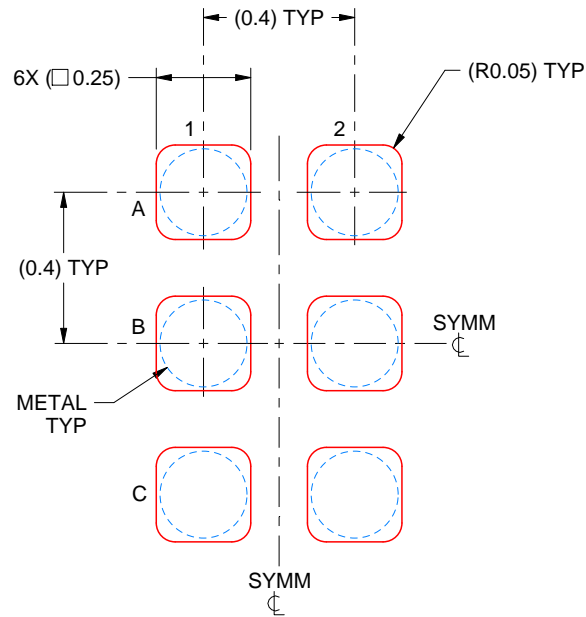

SOLDER PASTE EXAMPLE  
BASED ON 0.1 mm THICK STENCIL  
SCALE:50X

4223410/A 11/2016

NOTES: (continued)

4. Laser cutting apertures with trapezoidal walls and rounded corners may offer better paste release.

YZP0006

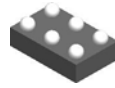

PACKAGE OUTLINE

DSBGA - 0.5 mm max height

DIE SIZE BALL GRID ARRAY

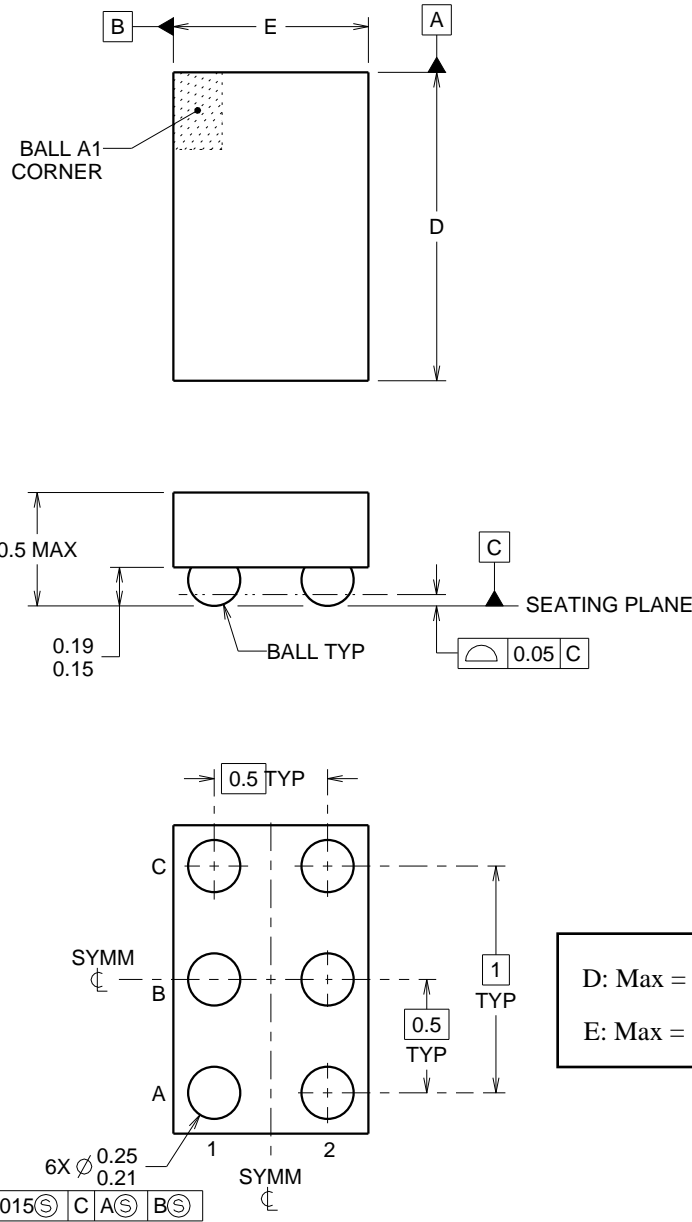

D: Max = 1.418 mm, Min = 1.358 mm  
 E: Max = 0.918 mm, Min = 0.858 mm

4219524/A 06/2014

NOTES:

NanoFree Is a trademark of Texas Instruments.

1. All linear dimensions are in millimeters. Any dimensions in parenthesis are for reference only. Dimensioning and tolerancing per ASME Y14.5M.
2. This drawing is subject to change without notice.
3. NanoFree™ package configuration.

# EXAMPLE BOARD LAYOUT

YZP0006

DSBGA - 0.5 mm max height

DIE SIZE BALL GRID ARRAY

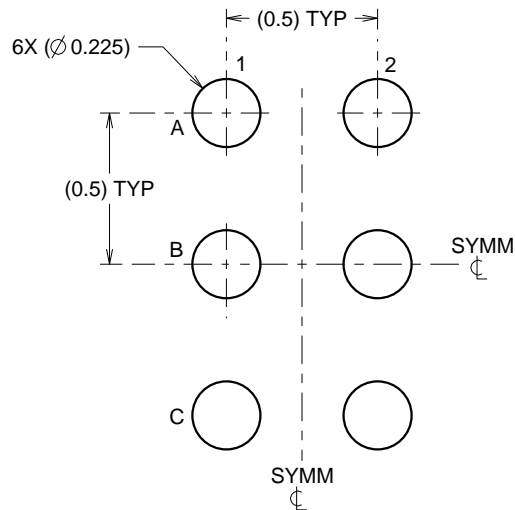

LAND PATTERN EXAMPLE  
SCALE:40X

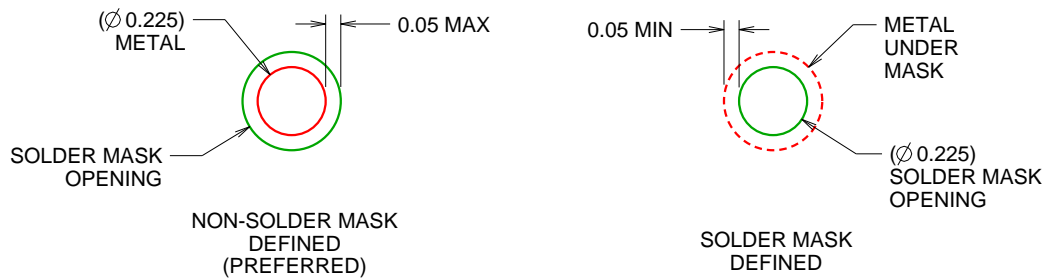

SOLDER MASK DETAILS  
NOT TO SCALE

4219524/A 06/2014

NOTES: (continued)

- Final dimensions may vary due to manufacturing tolerance considerations and also routing constraints. For more information, see Texas Instruments literature number SBVA017 ([www.ti.com/lit/sbva017](http://www.ti.com/lit/sbva017)).

# EXAMPLE STENCIL DESIGN

YZP0006

DSBGA - 0.5 mm max height

DIE SIZE BALL GRID ARRAY

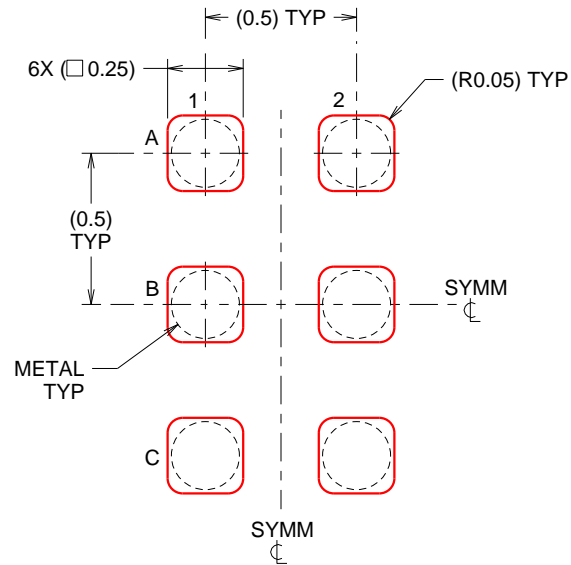

SOLDER PASTE EXAMPLE  
BASED ON 0.1 mm THICK STENCIL  
SCALE:40X

4219524/A 06/2014

NOTES: (continued)

5. Laser cutting apertures with trapezoidal walls and rounded corners may offer better paste release.

YZT (R-XBGA-N6)

DIE-SIZE BALL GRID ARRAY

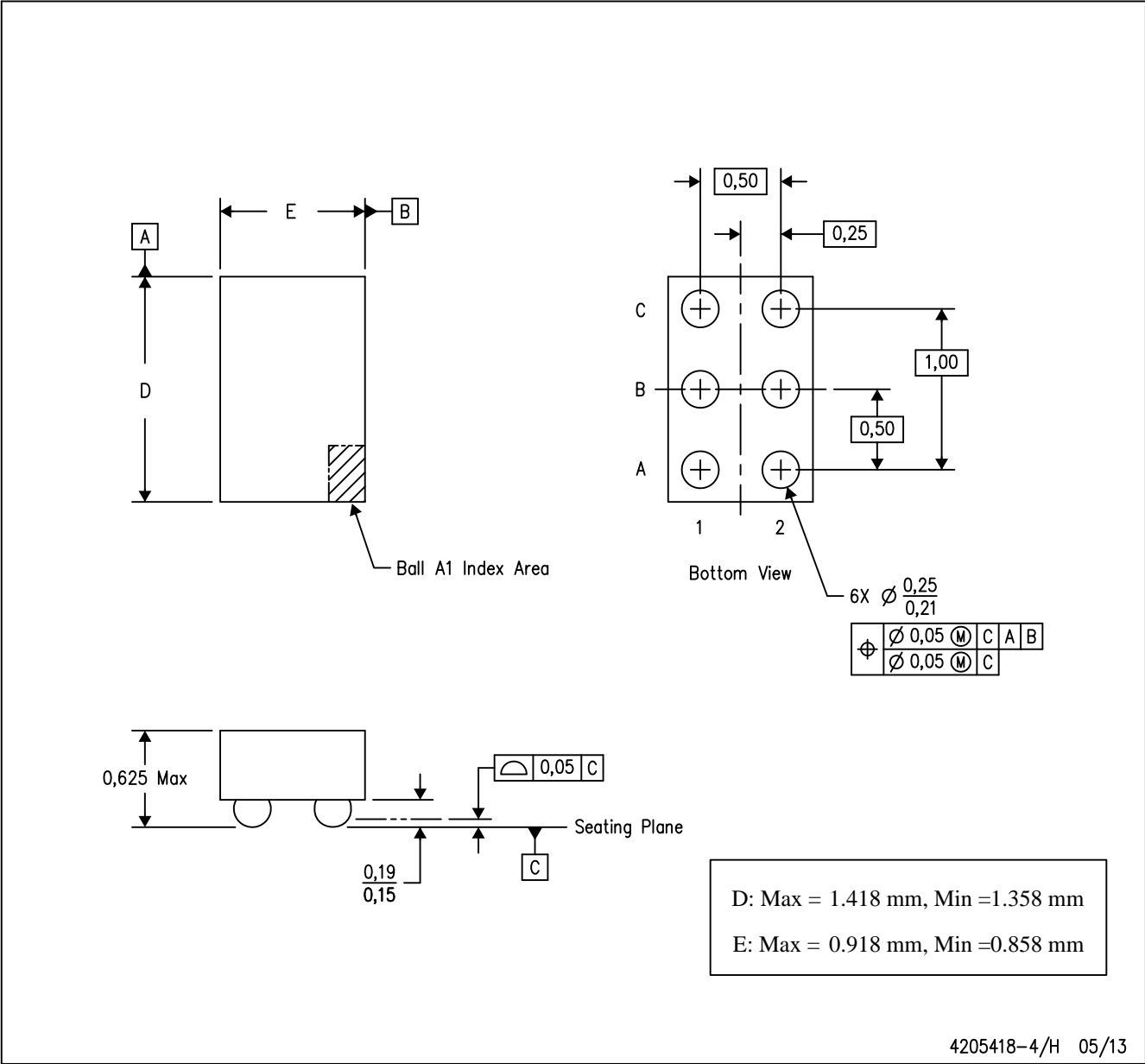

- NOTES:
- A. All linear dimensions are in millimeters. Dimensioning and tolerancing per ASME Y14.5M-1994.
  - B. This drawing is subject to change without notice.
  - C. NanoFree™ package configuration.

NanoFree is a trademark of Texas Instruments.

## IMPORTANT NOTICE AND DISCLAIMER

TI PROVIDES TECHNICAL AND RELIABILITY DATA (INCLUDING DATA SHEETS), DESIGN RESOURCES (INCLUDING REFERENCE DESIGNS), APPLICATION OR OTHER DESIGN ADVICE, WEB TOOLS, SAFETY INFORMATION, AND OTHER RESOURCES "AS IS" AND WITH ALL FAULTS, AND DISCLAIMS ALL WARRANTIES, EXPRESS AND IMPLIED, INCLUDING WITHOUT LIMITATION ANY IMPLIED WARRANTIES OF MERCHANTABILITY, FITNESS FOR A PARTICULAR PURPOSE OR NON-INFRINGEMENT OF THIRD PARTY INTELLECTUAL PROPERTY RIGHTS.

These resources are intended for skilled developers designing with TI products. You are solely responsible for (1) selecting the appropriate TI products for your application, (2) designing, validating and testing your application, and (3) ensuring your application meets applicable standards, and any other safety, security, regulatory or other requirements.

These resources are subject to change without notice. TI grants you permission to use these resources only for development of an application that uses the TI products described in the resource. Other reproduction and display of these resources is prohibited. No license is granted to any other TI intellectual property right or to any third party intellectual property right. TI disclaims responsibility for, and you will fully indemnify TI and its representatives against, any claims, damages, costs, losses, and liabilities arising out of your use of these resources.

TI's products are provided subject to [TI's Terms of Sale](#) or other applicable terms available either on [ti.com](https://www.ti.com) or provided in conjunction with such TI products. TI's provision of these resources does not expand or otherwise alter TI's applicable warranties or warranty disclaimers for TI products.

TI objects to and rejects any additional or different terms you may have proposed.

Mailing Address: Texas Instruments, Post Office Box 655303, Dallas, Texas 75265  
Copyright © 2024, Texas Instruments Incorporated

## Looking for pricing, stock, or lifecycle information?

Click below to explore more details on WIN SOURCE:

 [View TPS22922YZPR on WIN SOURCE](#)

 [Texas Instruments](#) Information

## Optimize Your Supply Chain with WIN SOURCE Solutions

-  Global Sourcing Solution
-  Obsolete Management
-  Cost Control Management
-  Shortage Management
-  Alternative Solution
-  Excess Inventory Management